



# PRICE LIST

PRECISION FARMING PRODUCTS



USD 2023-2024

# WHAT'S NEW?



## ECOSTOP NOZZLE CONTROL

The TeeJet EcoStop is a nozzle control system designed to help with minimal overlap, reduce chemical usage and minimize crop or turf damage.

*See pages 71-82*



## MATRIX® 908

The TeeJet Matrix 908 is an all new field computer; the bright 8" display and fully updated menu structure offers intuitive operations and quick setup.

*See pages 6-11*



## FLOW METERS

Two new flow meters have been added to TeeJet's line of sensors. The FM838 is a new turbine meter perfect for lower flow applications and the FM9380 electromagnetic flow meter features a large flow range with no moving parts for superior durability in a wide range of applications.

*See page 52*



## 845-AB

The TeeJet 845 platform has been expanded to include a 845-AB controller dedicated for orchard and vineyard applications. The 845-AB controller has new functions and enhanced functionality.

*See pages 35-38*



## IC45

New generation of the ISOBUS job computer to replace IC35. IC45 contains new features and enhanced functionality.

*See pages 42-46*



# Table of Contents

## GPS Guidance and Steering

Matrix® 430 .....	4
Matrix® 430VF .....	5
Matrix® 908 .....	6-9
Matrix® 908 Accessories .....	10
Matrix® 908 System Diagram .....	11
RX720.....	12
GPS Receivers & Accessories.....	13
UniPilot® Pro.....	14-15
UniPilot® Pro System Diagram.....	16

## Automatic Section Control

BoomPilot® Automatic Section Control .....	17-18
--	-------

## Monitors

Sentry 6120 Droplet Size Monitor .....	20
Sentry 6140/6141 Tip Flow Monitor .....	21-28

## Application Controls

744 Manual Sprayer Control.....	30-33
70 Series.....	34
845 Automatic Sprayer Control.....	35
Radion 8140 Automatic Sprayer Control .....	36
How to Order Automatic Sprayer Control .....	37
Automatic Sprayer Control Examples .....	38

## ISOBUS Application Controls

Universal Terminal and Switch Boxes.....	40-41
IC45 ECU Sprayer Job computer .....	42-46
IC38 ECU Spreader Job computer .....	47-50

## Flow Meters, Valves and Sensors

Flow Meters .....	52
Regulating Valves .....	53
Hydraulic Control Valves.....	54
GPS Speed and Pressure Sensors .....	54

## DynaJet Nozzle Control System

DynaJet® Flex 7140 .....	55-62
DynaJet® IC7140 Hybrid.....	63-67
DynaJet® IC7140 ISOBUS .....	68-70

## EcoStop Nozzle Control System

EcoStop Overview.....	72
EcoStop with IC45 System Diagram .....	73
EcoStop with ISM/BIM System Diagram .....	74
EcoStop Nozzle Control System Components.....	75-76
EcoStop How To Order.....	77-78
EcoStop with IC45 .....	79-80
EcoStop with ISM/BIM .....	81-82

## Comprehensive List

Comprehensive List.....	83-102
-------------------------	--------



Prices effective September 1, 2023

Prices are subject to change without notice and are subject to freight, duty and local taxes. All prices are EXW (Incoterms® 2010) if shipped to Buyer within the United States, and in all other circumstances DAP Buyer's location (Incoterms 2010) and are payable in U.S. Dollars. Terms and Conditions of sale are to be found on the final page of this document.

# GPS GUIDANCE

GPS GUIDANCE - GPS RECEIVERS-ACCESSORIES



# MATRIX® 430

Easy and compact guidance system. Matrix 430 is ideal for first-time users. The full-color, 109mm/4.3inch touchscreen display allows the operator to efficiently navigate fields with minimal skips and overlaps in coverage.

All kits are equipped with all the necessary accessories. You can order components separately if there is a need for replacement.



## MATRIX® 430 GUIDANCE (BROAD ACREAGE)

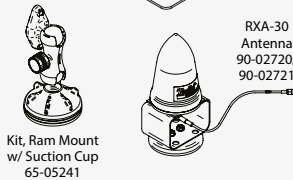
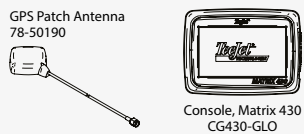

PART NO.	DESCRIPTION	U.S. DOLLARS
<b>MATRIX 430 KITS</b>		
GD430-GLO-P-B	Kit, Matrix 430, GLONASS, Patch Antenna, Battery Leads.....	\$ 1,995.10
GD430-GLO-P-L	Kit, Matrix 430, GLONASS, Patch Antenna, US Lighter Connector	1,995.10
GD430-GLO-R30-B	Kit, Matrix 430, GLONASS, RXA-30 Antenna, Battery leads .....	2,510.03
GD430-GLO-R30-L	Kit, Matrix 430, GLONASS, RXA-30 Antenna, US Lighter Connector.	2,510.03

MATRIX 430 KITS SHOWN ON THIS PAGE ARE SUBJECT TO GUIDANCE DISCOUNT

PART NO.	DESCRIPTION	U.S. DOLLARS
<b>COMPONENTS</b>		
CG430-GLO	Console, Matrix 430, GLONASS .....	\$ 2,106.49
45-05970	Cable, Matrix 430 Power/Sense/Speed(w/Switch) .....	260.43
45-05645	Cable, Power, US Style Lighter Adapter 4.5'/1.4 m.....	126.06
45-05775	Cable, Power, Direct to Battery, 10'/3 m .....	140.15
45-05343	Cable, Extension 10' CenterLine.....	239.29
65-05241	Kit, Ram Mount with Suction Cup .....	42.47
65-05179	Metal Mounting Plate (Also Requires 3 Velcro Strips #60-10081)	15.19
78-50190	Antenna, GPS Patch L1 with GLONASS .....	312.99
90-02720	Kit, RXA-30 Antenna with 20'/6 m Cable .....	829.65
90-02721	Kit, RXA-30 Antenna with 30'/9 m Cable .....	892.66

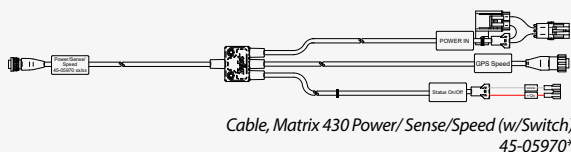
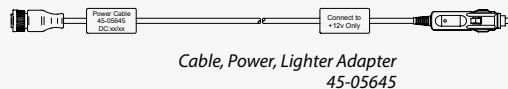
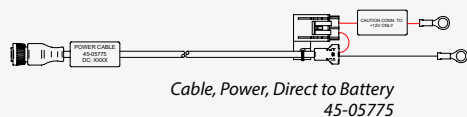

- Connector:
- Power supply
  - Speed info
  - Boom sense on/off

\*A separate power cable is required. For cig, use 45-05279. For ring terminals, use 401-0016 (2') or 45-05298 (12').

# MATRIX® 430VF

Our new guidance system is specifically designed to simplify your work in vineyards and orchards. Icon-based and easy to understand screen allows operator to efficiently navigate through the vineyards and orchards avoiding overlaps and missing rows. Full-color 109mm/4.3inch touchscreen display is an ideal fit for a small cab. With Matrix 430VF, night time operation is no longer a problem.



**NEW  
PRODUCT**

## MATRIX® 430VF GUIDANCE (VINEYARDS/ORCHARDS)

GPS GUIDANCE

PART NO.

DESCRIPTION

U.S. DOLLARS

### MATRIX 430VF KITS\*

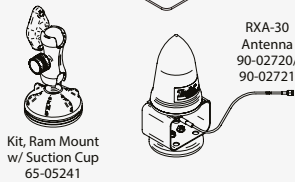
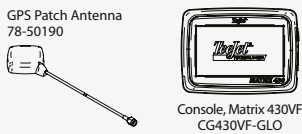

GD430VF-GLO-P-B	Kit, Matrix 430VF, GLONASS, Patch Antenna, Battery leads .....	\$ 1,995.10
GD430VF-GLO-P-L	Kit, Matrix 430VF, GLONASS, Patch Antenna, US Lighter Connector	1,995.10
GD430VF-GLO-R30-B	Kit, Matrix 430VF, GLONASS, RXA-30 Antenna, Battery leads .....	2,510.03
GD430VF-GLO-R30-L	Kit, Matrix 430VF, GLONASS, RXA-30 Antenna, US Lighter Connector	2,510.03

MATRIX 430 KITS SHOWN ON THIS PAGE ARE SUBJECT TO GUIDANCE DISCOUNT

### COMPONENTS

CG430VF-GLO	Console, Matrix 430VF, GLONASS .....	\$ 2,106.49
45-05970	Cable, Matrix 430 Power/Sense/Speed(w/Switch) .....	260.43
45-05645	Cable, Power, US Style Lighter Adapter 4.5'/1.4 m .....	126.06
45-05775	Cable, Power, Direct to Battery, 10'/3 m .....	140.15
45-05343	Cable, Extension 10' CenterLine .....	239.29
65-05241	Kit, Ram Mount with Suction Cup .....	42.47
65-05179	Metal Mounting Plate (Also Requires 3 Velcro Strips #60-10081)	15.19
78-50190	Antenna, GPS Patch L1 with GLONASS .....	312.99
90-02720	Kit, RXA-30 Antenna with 20'/6 m Cable .....	829.65
90-02721	Kit, RXA-30 Antenna with 30'/9 m Cable .....	892.66

\* Matrix 430VF is new and it is specifically designed to work in vineyards and orchards. For further information, please contact your TeeJet Regional Sales Manager.



Cable, Power, Direct to Battery  
45-05775

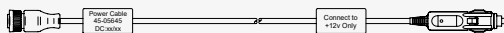

Cable, Power, Lighter Adapter  
45-05645

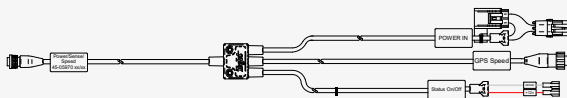

Cable, Matrix 430 Power/Sense/Speed (w/Switch)  
45-05970\*



- Connector:
- Power supply
  - Speed info
  - Boom sense on/off

\*A separate power cable is required. For cig, use 45-05279. For ring terminals, use 401-0016 (2') or 45-05298 (12').

# MATRIX<sup>®</sup> 908

The TeeJet<sup>®</sup> Matrix<sup>®</sup> 908 is an all new field computer with expandable options to appeal to any agricultural application. The fully redesigned platform features an 8-inch diagonal high-resolution display that is the perfect match to being cost effective and functional for high-end applications.



**NEW  
PRODUCT**

## THE KITS AVAILABLE

**MATRIX<sup>®</sup> 908 NAV**

**MATRIX<sup>®</sup> 908 ISO**

**NAV = NAVIGATION\***

- Guidance
- Auto-steering
- Section control
- Variable Rate Application

**ISO = ISOBUS & NAVIGATION**

- Guidance
- Auto-steering
- Section control
- Variable Rate Application
- ISOBUS Terminal
- ISOBUS Task Controller \*\*

\* A feature unlock is available to upgrade from Matrix 908 NAV to Matrix 908 ISO.

\*\* VRA functionality requires an additional unlock code.

## GNSS CORRECTIONS AVAILABLE

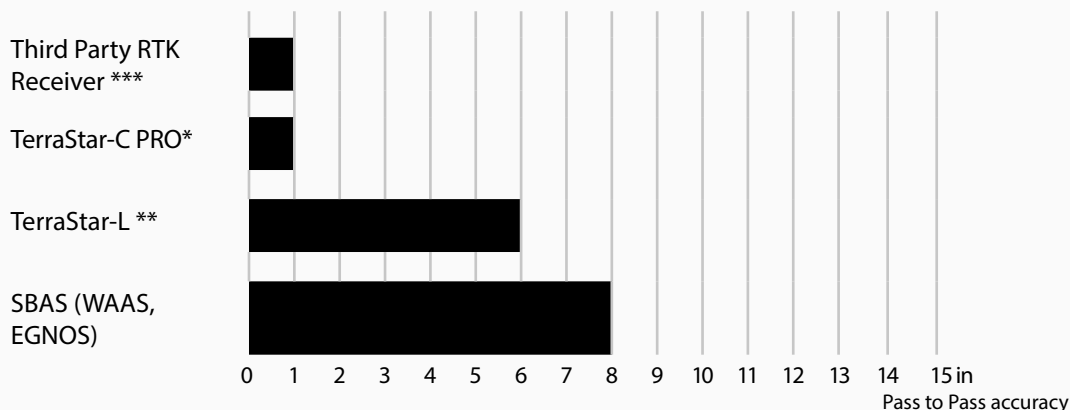

\* TerraStar-C Pro requires a subscription

\*\* TerraStar-L requires a subscription

\*\*\* RTK requires an external third receiver not sold by TeeJet Technologies. For more information contact your Regional Sales Manager

GPS GUIDANCE



# MATRIX 908 NAV WITH HARNESS

MATRIX 908 KITS SHOWN ON THIS PAGE ARE SUBJECT TO GUIDANCE DISCOUNT

## 90-10006-ENUS KIT PARTS DIAGRAM

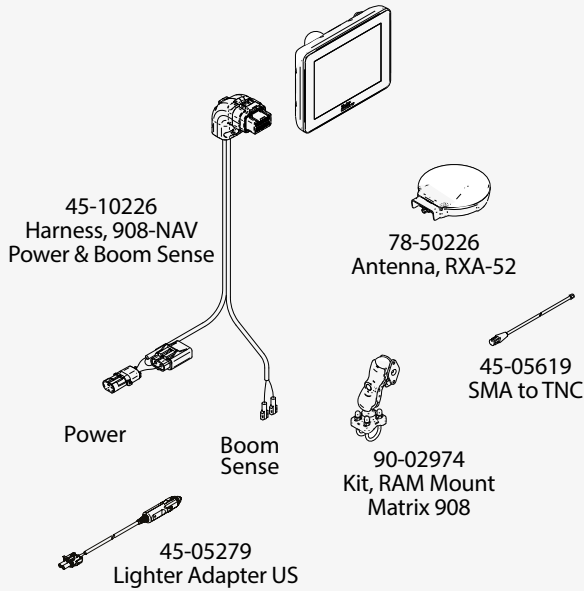

PART NO.	DESCRIPTION	U.S. DOLLARS
<b>NAV KITS WITH INTERNAL RECEIVER</b>		
90-10006-ENUS	KIT, M908 NAV-L1-GLO-ENUS .....	\$ 3,258.95
90-10007-ENUS	KIT, M908 NAV-L2+TSL-GLO-ENUS.....	3,457.95
90-10008-ENUS	KIT, M908 NAV-L2+TSC-GLO-ENUS..... <b>NEW LOWER PRICE!</b>	4,826.68

## MORE INFORMATION ABOUT KITS

The kits 90-10006-xx, 90-10007-xx & 90-10008-xx contain the parts number below.

75-100xx-EN	Matrix 908 NAVIGATION display .....
45-05279	Cable, Power Cigarette Lighter .....
45-10226	Harness Matrix 908, Nav, Power & Boom Sense.....
RXA-52-20	Kit RXA-52 with antenna, mounting plate and cable 20'6 meter
90-02974	RAM Mount Kit for Matrix 908.....
90-07009	Screen cleaning cloth Matrix 908 .....
98-01578-xx	User manual, Matrix 908.....

Functions supported by the harness in kits 90-10006-xx, 90-10007-xx & 90-10008-xx



Manual guidance

## CONSOLE FUNCTION DESCRIPTION KEY

# M908 NAV-L1-GLO-EN

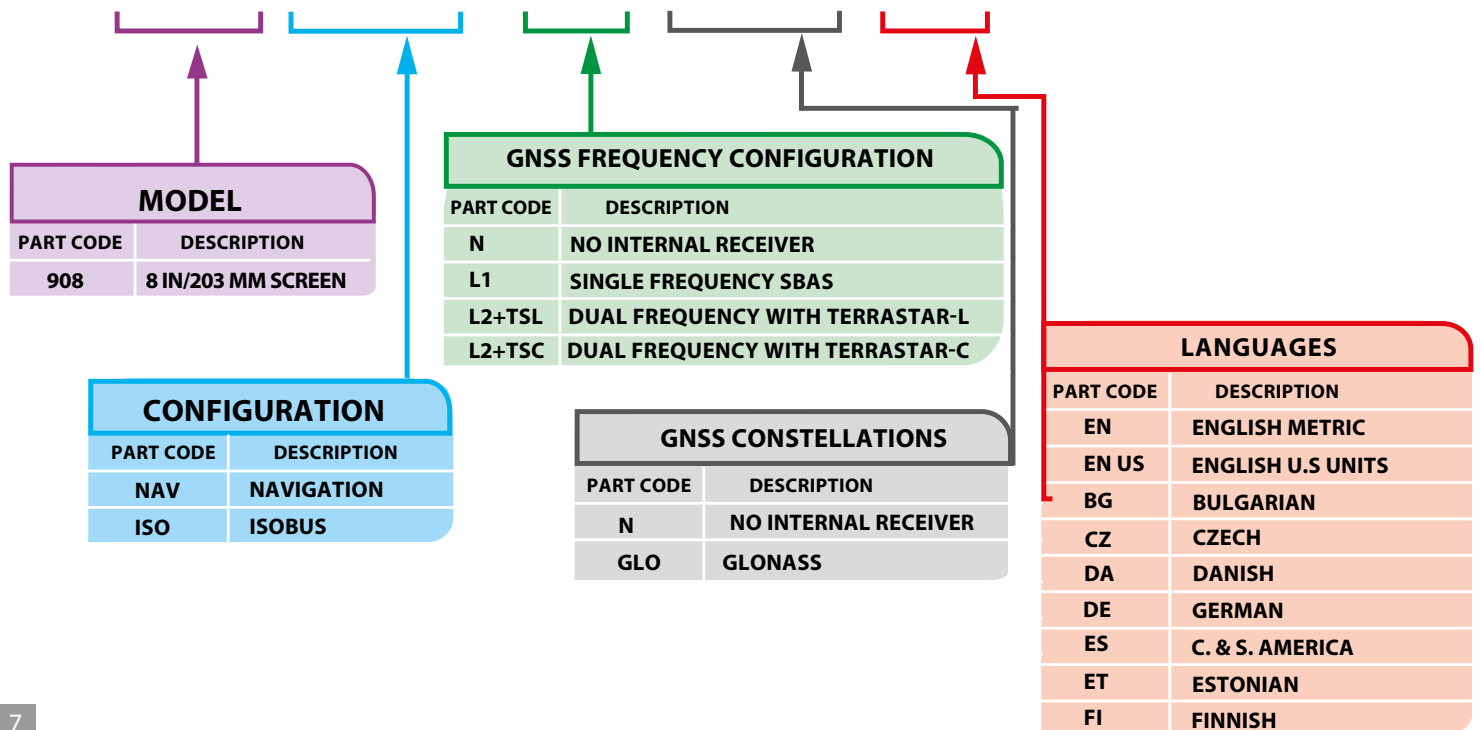

MATRIX 908 KITS SHOWN ON THIS PAGE ARE SUBJECT TO GUIDANCE DISCOUNT

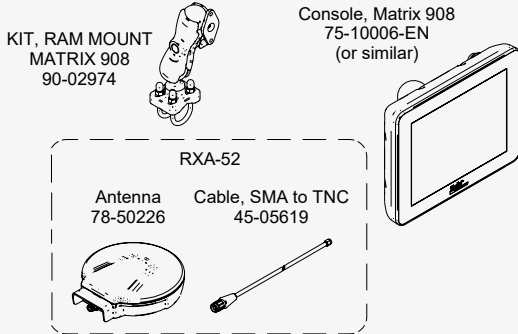

## STEP 1: CHOOSE YOUR KIT

PART NO.	DESCRIPTION	U.S. DOLLARS
<b>NAV KIT WITH INTERNAL RECEIVER</b>		
90-10006-ENUS-NH	KIT, M908 NAV-L1-GLO-ENUS, NO HRNS.....	\$ 3,093.40
90-10007-ENUS-NH	KIT, M908 NAV-L2+TSL-GLO-ENUS, NO HRNS.....	3,292.40
90-10008-ENUS-NH	KIT, M908 NAV-L2+TSC-GLO-ENUS, NO HRNS <b>NEW LOWER PRICE!</b>	4,661.13

## STEP 2: CHOOSE YOUR HARNESS

PART NO.	DESCRIPTION	U.S. DOLLARS
<b>MATRIX 908 HARNESS</b>		
45-10214	Harness, Matrix 908, NAV, 6'/2.35 m All connections except ISOBUS CAN .....	\$ 656.36
45-10226	Harness, Matrix 908, NAV, 6'/2.35m Boom Sense/Power in .....	206.81
45-10236	Harness, Matrix 908, NAV, 6'/2.35 m TeeJet CAN/ Speed/ BS/ RS/ Power in .....	406.49
<b>POWER CABLES</b>		
401-0016	Cable Power, 1 Lead, 2'/0.6m .....	\$ 84.80
45-05298	Cable, 12', 2 Position Battery .....	127.10
45-05381	Cable, 3 POS. Battery 12' /3.6m with 15 Amp Fuses .....	209.92
45-05279	Cable, Power Cigarette Lighter .....	127.10

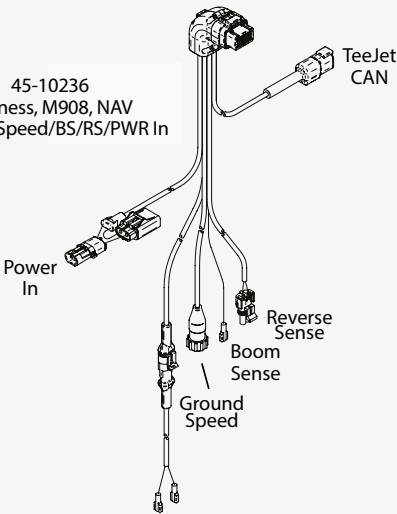

## MATRIX 908 WITH RATE CONTROL EXAMPLES

### 845 RATE CONTROL SYSTEM MATRIX 908 AND AUTO SECTION CONTROL

#### EXAMPLE:

90-50268	Kit, 845, Mounting Bracket, PWR Cable, User Guide.....	\$ 1,721.11
45-10106-MD	Harness, 5 Sect. Ball Valves, MINI-DIN.....	1,322.24
90-10006-ENUS-NH**	Kit, M908 NAV-L1-GLO-ENUS, No Hrns .....	3,093.40
45-10236	Harness, 908-NAV-TJD-PWP-RS-SS-PO-SP .....	406.49
90-02990	Kit, BoomPilot SDM/Harness, TeeJet 844, M908 .....	2,183.57
45-20042	Cable, 844 to Dj 39512 .....	120.82
<b>Total.....</b>		<b>\$ 8,847.63</b>

### RADION 8140 RATE CONTROL SYSTEM MATRIX 908 AND AUTO SECTION CONTROL

#### EXAMPLE:

90-50259	Kit, Radion 8140-5, RAM Mount, PWR Cable, User Guide... ..	\$ 3,623.47
45-10106-MD	Harness, 5 Sect. Ball Valves, MINI-DIN.....	1,322.24
90-10006-ENUS-NH**	Kit, M908 NAV-L1-GLO-ENUS, No Hrns.....	3,093.40
45-10236	Harness, 908-NAV-TJD-PWP-RS-SS-PO-SP.....	406.49
45-04068	Cable, Radion CAN to M908, 6 POS DTM W/TERM., 7'.....	226.70
98-50143	Unlock Code, ABSC for Radion Console.....	1,151.58
<b>Total.....</b>		<b>\$ 9,823.88</b>

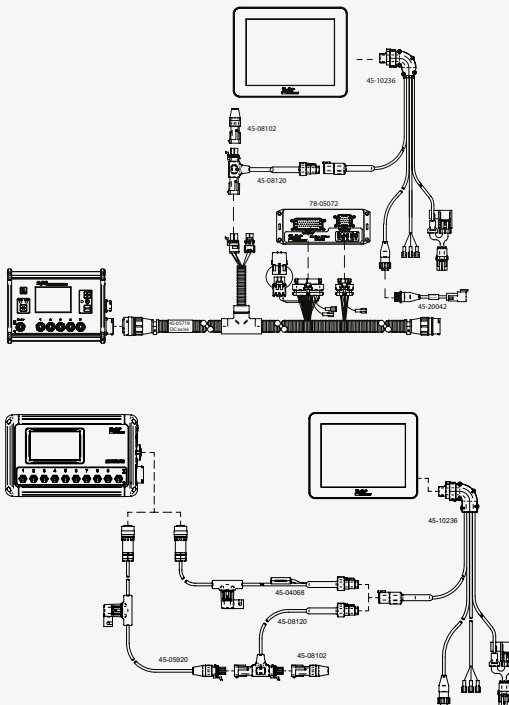

MATRIX 908 KITS SHOWN ON THIS PAGE ARE SUBJECT TO GUIDANCE DISCOUNT

### 90-10011-XX KIT PARTS DIAGRAM

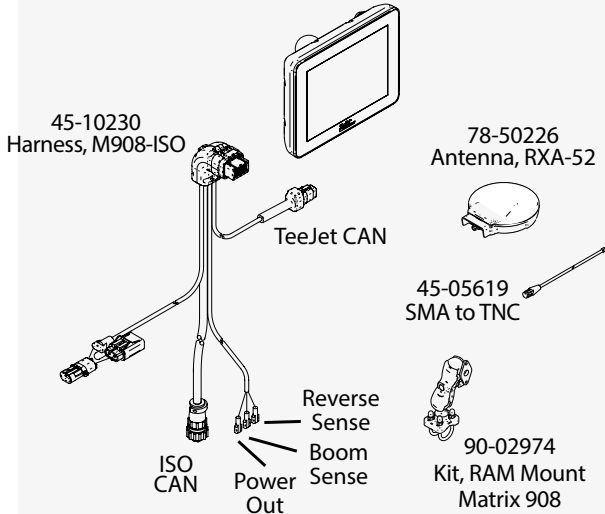

PART NO.	DESCRIPTION	U.S. DOLLARS
<b>ISO KIT WITH INTERNAL RECEIVER</b>		
90-10011-ENUS	KIT, M908 ISO-L1-GLO-ENUS.....	\$ 4,432.64
90-10012-ENUS	KIT, M908 ISO-L2+TSL-GLO-ENUS.....	4,631.64
90-10013-ENUS	KIT, M908 ISO-L2+TSC-GLO-ENUS..... <b>NEW LOWER PRICE!</b>	6,000.37

### MORE INFORMATION ABOUT KITS

The kits 90-10011-xx, 90-10012-xx & 90-10013-xx contain the part numbers below.

75-100xx-EN	Matrix 908 ISOBUS display.....
45-10230	Harness, Matrix 908, 6'/2.35 m TeeJet CAN/ ISOBUS CAN/ RS/ BS/ Power in .....
90-02974	RAM Mount Kit for Matrix 908.....
90-07009	Screen cleaning cloth Matrix 908 .....
98-01578-xx	User manual, Matrix 908.....

## SYSTEM DIAGRAM

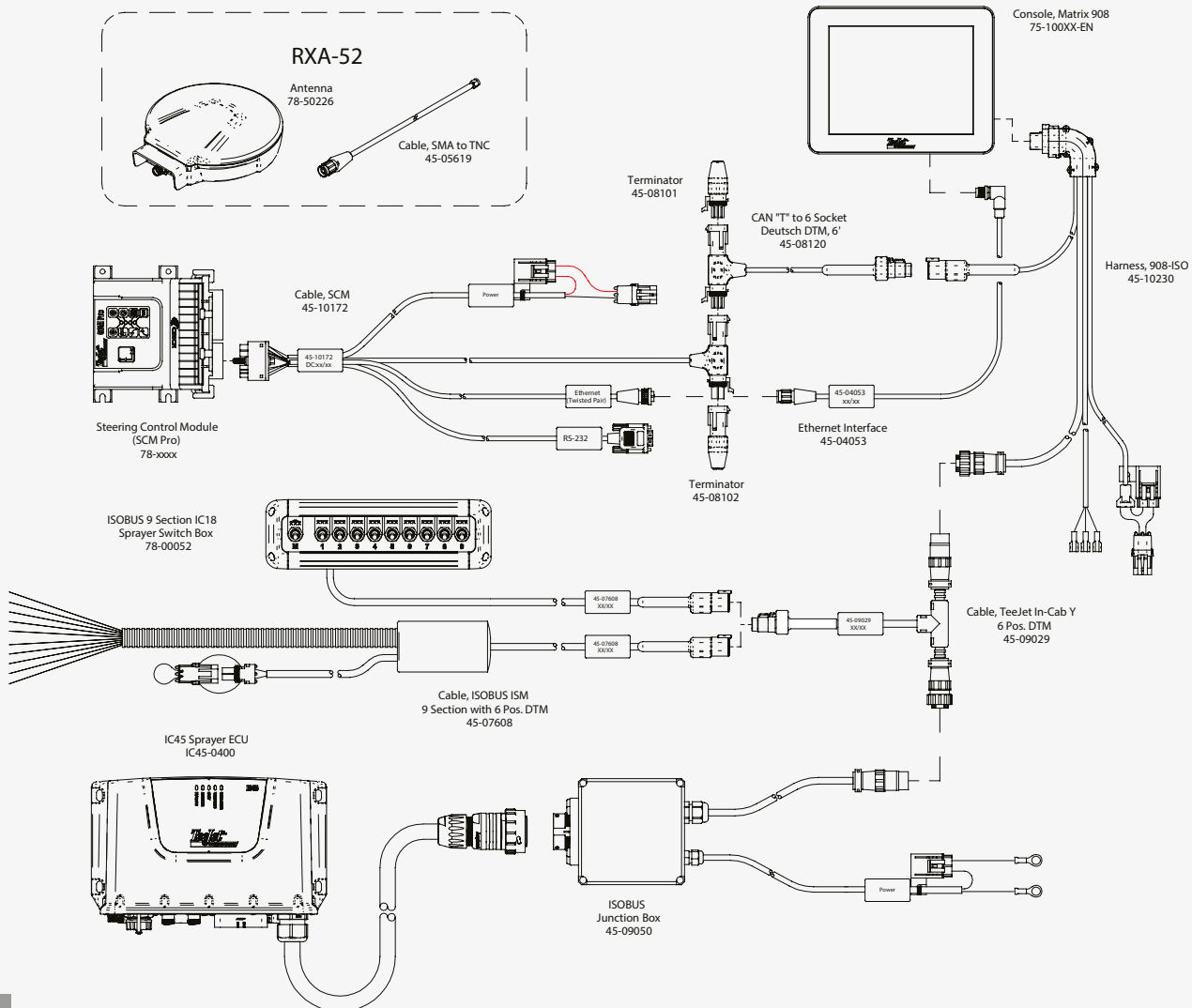



# MATRIX<sup>®</sup>908 ACCESSORIES

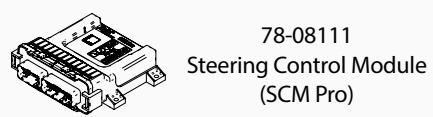
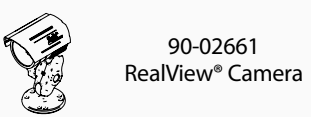
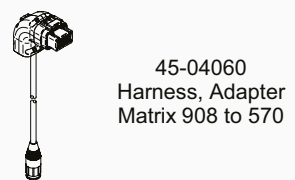
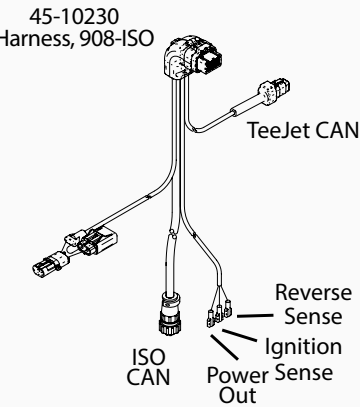
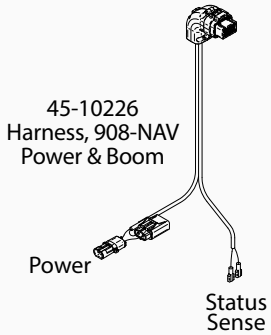

PART NO.	DESCRIPTION	U.S. DOLLARS
----------	-------------	--------------

## FEATURE UNLOCKS

99-01101	Unlock Code , Matrix 908, ISOBUS UT & TC.....	\$ 1,173.69
99-01097	Unlock Code , Matrix 908, VRA , Prescription application.....	1,173.69

Note: Subject to guidance discount

## GNSS UPGRADES

99-01102	GNSS Upgrade Matrix 908, Base to L1/L2, TSL READY.....	\$ 199.00
99-01103	GNSS Upgrade Matrix 908, Base to TSC-PRO READY.....	1,567.73

Note: Subject to guidance discount

## GNSS SUBSCRIPTIONS

99-01087	Subscription, TERRASTAR-C PRO, 3 Months, Regional.....	\$ 750.00*
99-01088	Subscription, TERRASTAR-C PRO, 1 Year, Regional.....	1,050.00*
99-01089	Subscription, TERRASTAR-C PRO, 2 Years, Regional.....	1,895.00*
99-01090	Subscription, TERRASTAR-C PRO, 3 Years, Regional.....	2,675.00*
99-01075	Subscription, TERRASTAR-L, 1 Year, Regional.....	350.00*
99-01076	Subscription, TERRASTAR-L, 2 Years, Regional.....	665.00*
99-01077	Subscription, TERRASTAR-L, 3 Years, Regional.....	980.00*

\* No Discounts apply

## MAIN HARNESS

45-10214	Harness, Matrix 908, 6'/2.35 m All connections except ISOBUS CAN.....	\$ 656.36
45-10215	Harness, Matrix 908, 6'/2.35 m All connections.....	702.08
45-10226	Harness, Matrix 908, 6'/2.35 m Boom Sense, Power in.....	206.81
45-10236	Harness, Matrix 908, 6'/2.35 m TeeJet CAN/ Speed/ BS/ RS/ Power in.....	406.49
45-10230	Harness, Matrix 908, 6'/2.35 m TeeJet CAN/ ISOBUS CAN/ RS/ BS/ Power in.....	544.92

## ADAPTER CABLES

45-04060	Cable, adapter Matrix 908 to Matrix 570/840 Cables.....	\$ 205.00
45-04053	Cable, Ethernet interface RJ45 to 5. POS CONXALL.....	150.30
45-08120	Cable, Can"T" to 6 Socket Deutsch.....	170.23

## TERMINATOR

45-08102	Terminator, CAN Female.....	\$ 65.96
45-08101	Terminator, CAN Male.....	65.96

## POWER CABLES

401-0016	Cable Power, 1 Lead, 2'/.0.6m.....	\$ 84.80
45-05381	Cable, 3 POS. Battery 12' with 15 Amp Fuses.....	209.92
45-05279	Cable, Power Cigarette Lighter.....	127.10

## ANTENNA

RXA-52-20	Kit, RXA-52, Antenna 20'/6M.....	\$ 1,241.15
RXA-52-30	Kit, RXA-52, Antenna, 30'/9M.....	1,260.14
45-05619	Cable, SMA Male to TNC Male, 20'/6m.....	211.44
45-05620	Cable, SMA Male to TNC Male, 30'/9m.....	328.27

## MOUNTING

90-02974	Kit, RAM Mount, Matrix 908.....	\$ 157.28
78-50179	Magnetic Mount for Camera.....	75.46
65-05185	RAM Mount for Camera.....	75.46

GPS GUIDANCE

# MATRIX<sup>908</sup> SYSTEM DIAGRAM

GPS GUIDANCE

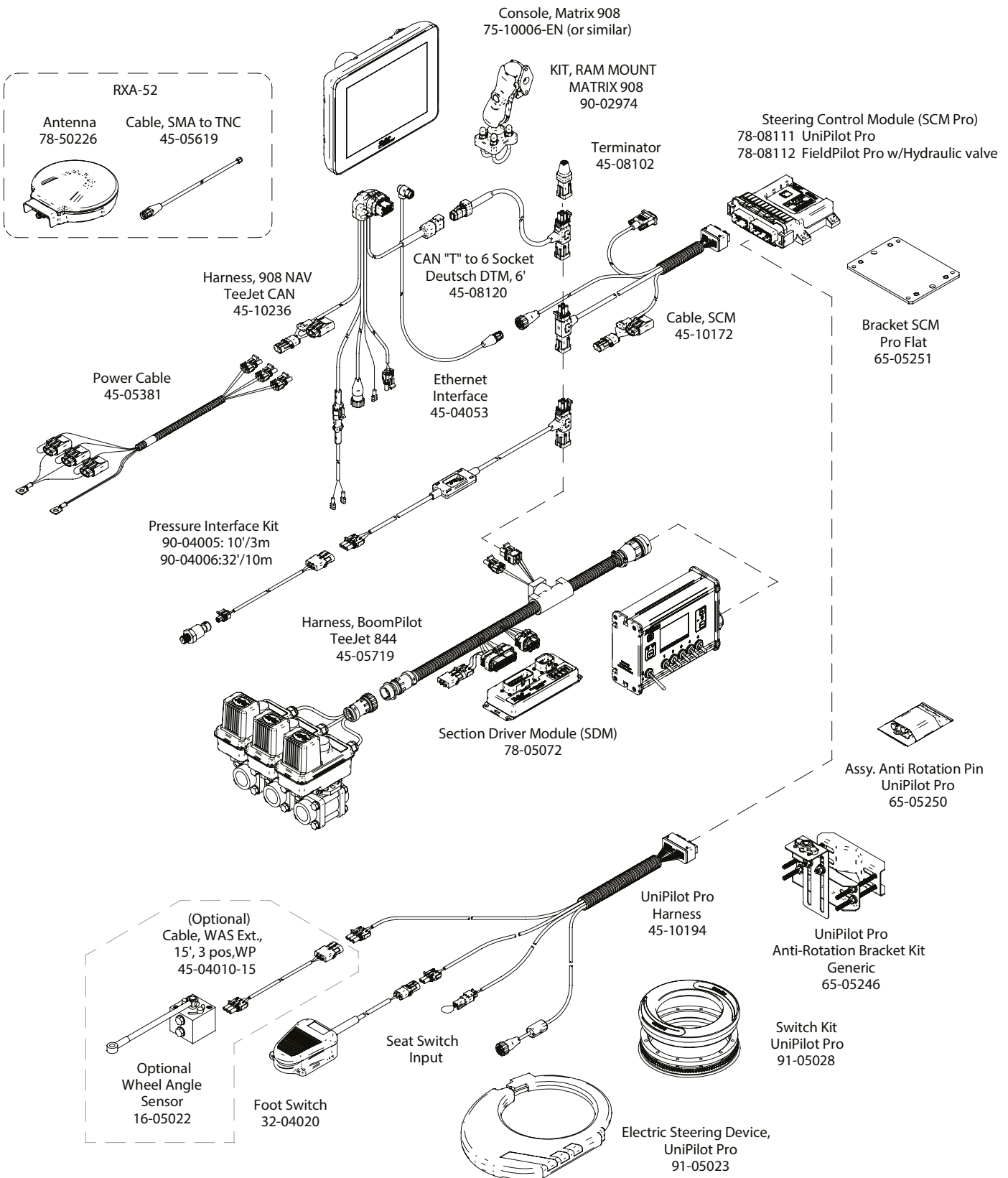

*Note: Matrix 908 System Diagram connectivity to some devices may be released with future software releases. Always refer to software release notes for software/system connectivity at [www.teejet.com/support/software.aspx](http://www.teejet.com/support/software.aspx).*

# RX720

## MULTI-FREQUENCY MULTI-CONSTELLATION GNSS SMART ANTENNA



A high-quality internal antenna element combined with the ability to track 555 channels makes the RX720 extremely flexible. This receiver can receive GPS, GLONASS, BeiDou, Galileo and QZSS, along with TerraStar correction signals. This results in high numbers of satellite signals and a wide range of configurations that can deliver the accuracy your application needs – from subscription free SBAS (WAAS, EGNOS, MSAS, GAGAN) corrections through TerraStar-L and TerraStar-C PRO, and even centimeter-level RTK accuracy with TerraStar-X.

# RX720 GNSS SMART ANTENNA

GPS GUIDANCE

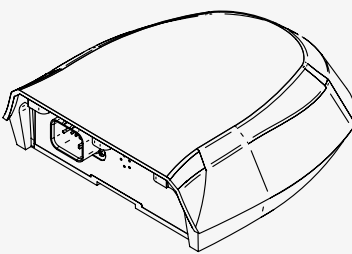
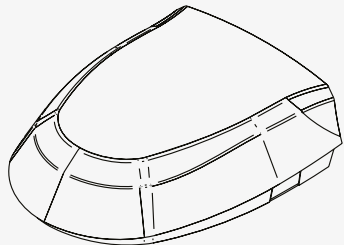

PART NO.	DESCRIPTION	U.S DOLLARS
<b>KITS</b>		
90-02942	Kit, GNSS Receiver, RX720, Dual Freq., TSL ready, CP, No-SBAS.	\$ 4,122.24
90-02943	Kit, GNSS Receiver, RX720, Dual Freq., TSL ready, CP, SBAS	4,122.24
90-02944	Kit, GNSS Receiver, RX720, MCMF, TSL & TSC-Pro ready, CP, SBAS	7,181.66
90-02945	Kit, GNSS Receiver, RX720, MCMF, TSL & TSC-Pro ready, CP, no-SBAS	7,181.66
90-02946	Kit, GNSS Receiver, RX720, MCMF, TSL/TSC-Pro/TSX ready, CP, SBAS	9,575.98

### GNSS RECEIVER UPGRADES

99-01078	Upgrade, RX720, base unit to TSC-Pro ready & all constellations	\$ 3,125.93
99-01079	Upgrade, RX720, TSC-Pro ready to TSX ready & all constellations	2,674.39
99-01080	Upgrade, RX720, base unit to TSC-Pro/TSX ready & all constellations	5,518.93

Note: TSC-Pro subscription activation includes and automatically applies the unlock for all constellations (GPS, GLO, GAL, BDS). TSC-Pro subscription activation does not include the upgrade unlock to upgrade base unit to TSC-Pro ready.

### SUBSCRIPTIONS

99-01087	Subscription, TERRASTAR-C PRO, 3 months, Regional	\$ 750.00*
99-01088	Subscription, TERRASTAR-C PRO, 1 year, Regional	1,050.00*
99-01089	Subscription, TERRASTAR-C PRO, 2 years, Regional	1,895.00*
99-01090	Subscription, TERRASTAR-C PRO, 3 years, Regional	2,675.00*
99-01094	Subscription, TERRASTAR-X, 1 year, Regional	1,050.00*
99-01096	Subscription, TERRASTAR-X, 5 year, Regional	4,725.00*
99-01075	Subscription, TERRASTAR-L, 1 year, Regional	350.00*
99-01076	Subscription, TERRASTAR-L, 2 years, Regional	665.00*
99-01077	Subscription, TERRASTAR-L, 3 years, Regional	980.00*

\* No Discounts apply





# GPS RECEIVERS & ACCESSORIES

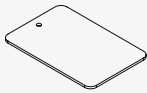
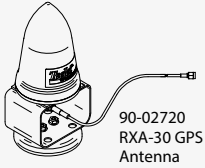

PART NO.	DESCRIPTION	U.S DOLLARS
<b>UPGRADE KITS</b>		
90-02472	Kit, Patch Antenna Extension 10'/3 m .....	\$ 189.72
90-02738	Kit, Patch Antenna w/ Mounting Hardware .....	337.53
90-02720	Kit, RXA-30 Antenna with 20'/ 6 m Cable .....	829.65
90-02721	Kit, RXA-30 Antenna with 30'/ 9 m Cable .....	892.66

<b>ANTENNA ONLY</b>		
78-50190	Antenna, GPS/GLONASS Patch, 5 m Cable.....	\$ 312.99

<b>CABLES/MISCELLANEOUS</b>		
45-05676	Cable, GPS Antenna Extension, 25'/ 7.5 m.....	\$ 269.30
45-05626	Cable Power CAN, RS232 Adapter to Conxall 8PG.....	323.30
45-05786	Cable, RXA-30 Antenna, 20'/ 6 m .....	247.90
45-05787	Cable, RXA-30 Antenna, 30'/ 9 m .....	366.34
45-05340	Cable, Deutsch To DB9 and Power In .....	226.22
45-05350	Cable, COM 1 & 2 With Power In .....	318.86
45-05501	Cable, GPS Ext. 25' .....	295.36
65-05179	Plate, Mounting for Patch Antenna .....	15.19
45-05957	Cable, RX720/RX520 to Power & Serial Com1 .....	234.36
45-05979	Plate, Mounting Kit for Patch Antenna .....	381.35
65-05243	Mounting Brack, RX520/RX720.....	168.39
78-50215	RXA-30 Antenna, No Cable .....	640.62



# ASSISTED STEERING

UNIPLOT PRO-COMPONENTS

# UNIPILOT® PRO

UniPilot® Pro delivers assisted steering in a package that lets you get the most from your TeeJet guidance system. Compatible with a huge range of equipment UniPilot Pro makes autosteer technology accessible to nearly every operator. Unlike other mechanical systems, there is no need to remove the steering wheel.



## UNIPILOT® PRO ASSISTED STEERING SYSTEM

PART NO.	DESCRIPTION	U.S DOLLARS
<b>UNIPILOT PRO SYSTEM ORDERING EXAMPLES</b>		
<b>EXAMPLE 1</b>	<b>TO ORDER A COMPLETE UNIPILOT PRO SYSTEM WITH MATRIX 908 USING SBAS</b>	
*90-10006-ENUS-NH	Kit, M908 NAV-L1-GLO-ENUS, No Harness .....	\$ 3,093.40
45-10236	Harness, 908-NAV-TJD-PWP-RS-SS-PO-SP .....	406.49
91-05039	Kit, UniPilot Pro, No WAS, Matrix .....	10,074.23
<b>EXAMPLE 2</b>	<b>TO ORDER A COMPLETE UNIPILOT PRO SYSTEM WITH MATRIX 908 USING HIGH ACCURACY CORRECTIONS (TERRASTAR-C PRO)</b>	
*90-10008-ENUS-NH	KIT, M908 NAV-L2+TSC-GLO-ENUS, NO HRNS. ....	\$ 4,661.13
45-10236	Harness, 908-NAV-TJD-PWP-RS-SS-PO-SP .....	406.49
91-05039	Kit, UniPilot Pro, NoWAS, Matrix 908 .....	10,074.23
99-01088	Subscription, TerraStar-C-Pro, 1 Year .....	1,050.00
<b>EXAMPLE 3</b>	<b>TO UPDATE A UNIPILOT PRO SYSTEM FOR MATRIX 908 (FROM MATRIX 570/840GS)</b>	
78-08111	Original SCM Pro is able to be updated by TeeJet .....	Call TeeJet
45-04053	Cable, Ethernet, Matrix 908 .....	150.30
45-08101	Terminator, CAN Male, WP .....	65.96
45-08102	Terminator, CAN Female, WP .....	65.96
45-08120	Cable, CAN Tee to DTM, 6 Foot .....	170.23
45-10172	Harness, Main, SCM Pro .....	348.32
45-10236	Harness, 908, NAV with TeeJet CAN .....	406.49
<b>EXAMPLE 4</b>	<b>TO ORDER ITEMS NEEDED TO INSTALL UNIPILOT PRO ON ADDITIONAL VEHICLE</b>	
45-08101	CAN, Terminator, 4 Pos. Male .....	\$ 65.96
45-10172	Harness, Main, FieldPilot, SCM .....	348.32
45-10194	Harness, ESD, w/WAS Connection .....	629.92
65-05246	Kit, Universal Anti-Rotation Bracket .....	296.44
65-05250	Assy, Anti Rotation Pin, UniPilot Pro .....	51.93
65-05251	Bracket, SCM Pro, Flat .....	231.87
91-05028	Switch kit, UniPilot Pro .....	1,406.50
<b>UNIPILOT PRO KITS</b>		
91-05039	Kit, UniPilot Pro, No WAS, Matrix 908 .....	\$ 10,074.23
91-05025	Kit, UniPilot Pro, No WAS, Matrix 570GS/840GS .....	10,003.77
<b>CABLES</b>		
45-04053	Cable, Ethernet, Matrix 908 .....	\$ 150.30
45-08120	Cable, CAN Tee to DTM, 6 Foot .....	170.23
45-10172	Harness, Main, FieldPilot, SCM .....	348.32
45-10194	Harness, ESD, w/WAS Connection .....	629.92
45-10236	Harness, 908-NAV-TJD-PWP-RS-SS-PO-SP .....	406.49
<b>COMPONENTS</b>		
32-04020	Kit, FieldPilot Pro Foot Switch .....	\$ 318.00
65-05246	Kit, Universal Anti-Rotation Bracket .....	296.44
65-05250	Assy, Anti Rotation Pin, UniPilot Pro .....	51.93
65-05251	Bracket, SCM Pro, Flat .....	231.87
91-05023	Electric Steering Device, UniPilot Pro .....	4,594.34
91-05028	Switch Kit, UniPilot Pro .....	1,406.50
<b>WHEEL ANGLE SENSOR</b>		
99-01074	Unlock Code, Wheel Angle Sensor (UniPilot Pro Only) .....	\$ 1,319.04
16-05022	Kit, Generirc Wheel Angle Sensor w/ Linkage .....	1,406.50
45-04010-15	Cable, WAS Extension, 15', 3 Pos WP .....	71.68

\* Kits shown on this page are subject to guidance discount

# UNIPILOT® PRO SYSTEM DIAGRAM

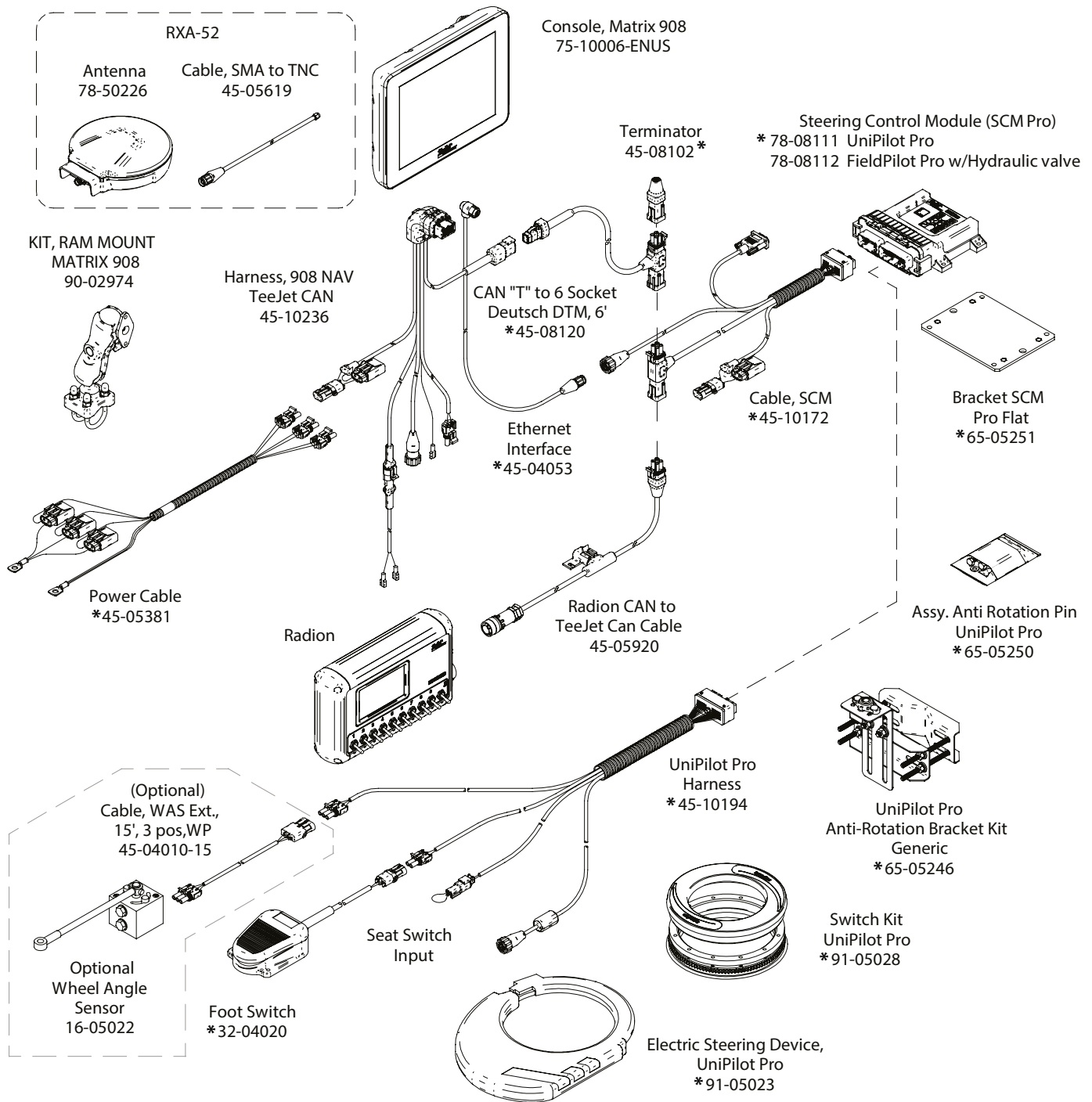

ASSISTED STEERING



\* Items included in the 91-05039 UniPilot Pro Kit.



# **AUTOMATIC SECTION CONTROLS**

**SPRAYER CONTROL KITS**

# BoomPilot®

BoomPilot uses your GPS position data to keep track of applied and unapplied areas of the field. This allows the boom sections to be automatically turned on or off to prevent skips and overlaps while spraying.



# BoomPilot®

## AUTOMATIC SECTION CONTROL

AUTOMATIC SECTION CONTROL

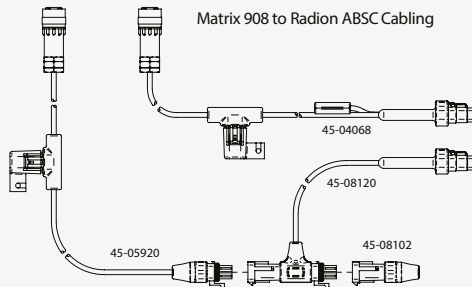

### RADION CAN ABSC FOR MATRIX 908

PART NO.	DESCRIPTION	U.S. DOLLARS
98-50143	Unlock Code, ABSC, For Radion Console .....	\$ 1,151.58
45-04068	Cable, Radion CAN to M908 6 POS DTM w/ Term 7' .....	226.70
45-05920	Cable, Radion CAN to TeeJet CAN, 4 POS WP .....	189.92
45-08120	Cable, CAN Tee to DM, 6' .....	170.23

### RADION CAN ABSC FOR MATRIX 570/840GS & AEROS

PART NO.	DESCRIPTION	U.S. DOLLARS
98-50143	Unlock Code, ABSC, For Radion Console .....	\$ 1,151.58
45-05914	Cable, Radion CAN To Matrix, 5' .....	273.50
45-05920	Cable, Radion CAN to TeeJet CAN, 4 POS WP .....	189.92
45-05925	Cable, Radion CAN to Matrix 10' .....	312.14

### SDM/HARNESS FOR MATRIX 908

90-02992	Kit, BoomPilot SDM/Harness Raven Spra Coupe 3000/4000 Series, Matrix 908	\$ 2,183.57
90-02991	Kit, BoomPilot SDM/Harness Raven 440-460, Matrix 908 .....	2,183.57
90-02990	Kit, BoomPilot SDM/Harness TeeJet 844/845, Matrix 908 .....	2,183.57
90-02989	Kit, BoomPilot SDM/Harness Generic, Matrix 908 .....	2,183.57

### SDM/HARNESS FOR MATRIX 570/840GS & AEROS

90-02572	Kit, BoomPilot SDM/Harness Generic .....	\$ 2,257.83
90-02666	Kit, BoomPilot SDM/Harness TeeJet .....	2,257.83
90-02667	Kit, BoomPilot SDM/Harness Raven 440-460 .....	2,257.83
90-02669	Kit, BoomPilot SDM/Harness Raven Spra Coupe 3000/4000 Series	2,887.91
90-02671	Kit, BoomPilot SDM/Harness Willmar w/ Mid-Tech Controls, Air Ride, Eagle 8100, 8500, Rangers .....	\$2,257.83
90-02672	Kit, BoomPilot SDM/Harness Spra Coupe 7xxx w/ Raven 4000 .....	2,257.83
90-02674	Kit, BoomPilot SDM/Harness 844 Classic US .....	2,257.83
90-02678	Kit, BoomPilot SDM/Harness Hagie, Split Signal, Raven 460 .....	2,257.83
90-02680	Kit, BoomPilot SDM/Harness Rogator '03-'06, DT Connector 8 POS	2,257.83
90-02681	Kit, BoomPilot SDM/Harness '09 Apache Raven 5000 .....	2,257.83
90-02682	Kit, BoomPilot SDM/Harness, 844E-9, Master Valve Support .....	2,257.83
90-02683	Kit, BoomPilot SDM/Harness Non-AGCO w/ Raven 4400 - 4600 .....	2,257.83
90-02756	Kit, BoomPilot SDM/Harness '10 and Newer Hagie STS .....	2,257.83
90-02760	Kit, BoomPilot SDM/Harness 12 POS Rogator DT-12 054/1254/1264 .....	2,257.83
90-02803	Kit, BoomPilot SDM/Harness, Miller Condor G Series .....	2,257.83

### COMPONENTS

78-05077	BoomPilot Section Driver Module Dependent Master (US) Software	\$ 1,575.23
78-05072	BoomPilot Section Driver Module Independent Master Software .....	1,575.23
45-05609	Harness, BoomPilot Generic .....	682.63
45-05719	Harness, BoomPilot TeeJet 844 .....	682.63
45-05720	Harness, BoomPilot Raven 440 .....	682.63
45-05738	Harness, BoomPilot Raven Spra Coupe 3000/4000 Series .....	1,312.71

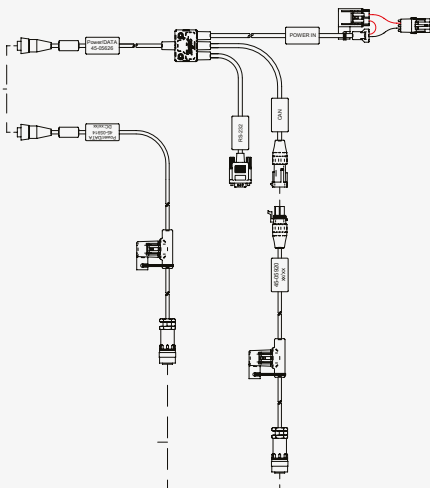
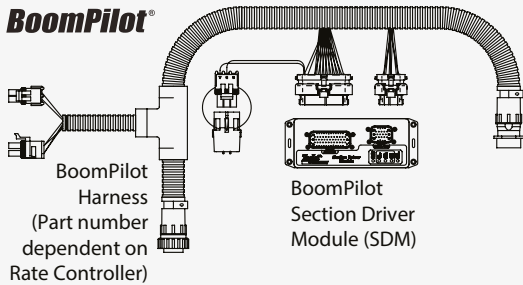

# MONITORS

DROPLET SIZE MONITOR - TIP FLOW MONITOR

# SENTRY 6120 DROPLET SIZE MONITOR

Provides real time operating pressure and corresponding droplet size category feedback for liquid applications. Image-based Tip Series and Tip Capacity settings allow for simple one-touch selection to choose your spray tip.



## SENTRY 6120 DROPLET SIZE MONITOR

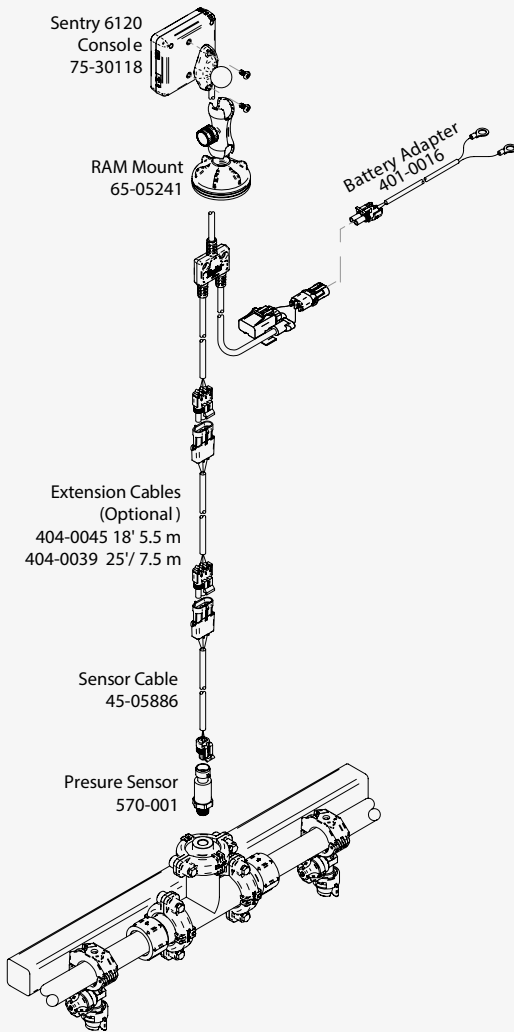

PART NO.	DESCRIPTION	U.S. DOLLARS
<b>KITS &amp; CONSOLES</b>		
90-02846	Kit, Sentry 6120 w/ US Lighter Cable .....	\$ 1,469.19
90-02848	Kit, Sentry 6120 w/ Battery Leads .....	1,476.85
75-30118	Console, Sentry 6120, Droplet Size Monitor .....	1,054.90
<b>CABLES AND POWER ADAPTERS</b>		
45-05279	Cable, US Style Cigarette Lighter.....	\$ 127.10
401-0016	Cable, Battery Adapter, 2' / 0.7 m.....	84.80
45-05886	Cable, Pressure Sensor, 25' / 8 m .....	111.30
404-0045	Cable, Ext, 18' / 5 m .....	149.92
404-0039	Cable, Ext, 25' / 8 m .....	165.90
<b>SENSORS</b>		
16-05015	Pressure Sensor, 10 Bar .....	\$ 345.02
<b>MOUNTING</b>		
65-05241	Kit, Sentry Ram Mount w/ Suction Cup.....	\$ 42.47

# SENTRY 6140/6141 TIP FLOW MONITOR

The Sentry 6140 Tip Flow Monitor provides a simple, reliable solution to monitor plugged or partially blocked spray tips. Flowmeters mounted at each spray tip location monitor the flow through the tip and provide instantaneous feedback to the operator should a tip become clogged. By eliminating the need to detect plugged tips visually from the cab, operators can cover more area in a day, and know, with confidence, that their spray tips or fertilizer metering orifices are operating properly. This system is ideal for sprayers, planter liquid fertilizer systems or liquid fertilizer applicators. Choose Sentry 6140 for a standalone system or Sentry 6141 for an ISOBUS compatible system.



## SENTRY 6140 TIP FLOW MONITOR

### SPRAYERS AND APPLICATORS WITH MULTIPLE BOOM SECTION VALVES

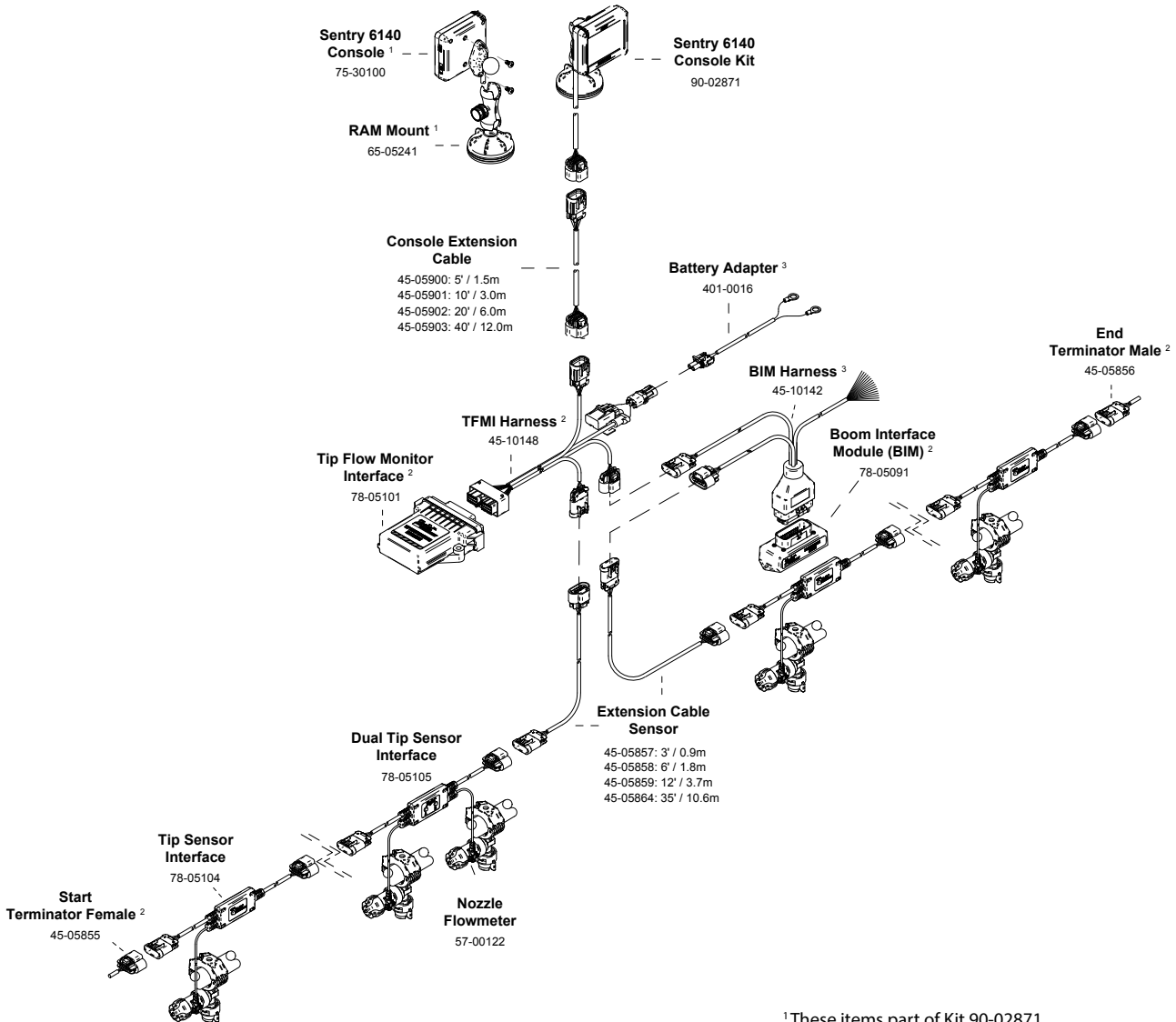

<sup>1</sup> These items part of Kit 90-02871

<sup>2</sup> These items part of Kit 90-02852

<sup>1, 2, & 3</sup> These items part of Kit 90-02860



# SENTRY 6140 TIP FLOW MONITOR

SPRAYERS AND APPLICATORS WITH SINGLE OR NO BOOM SECTION VALVES

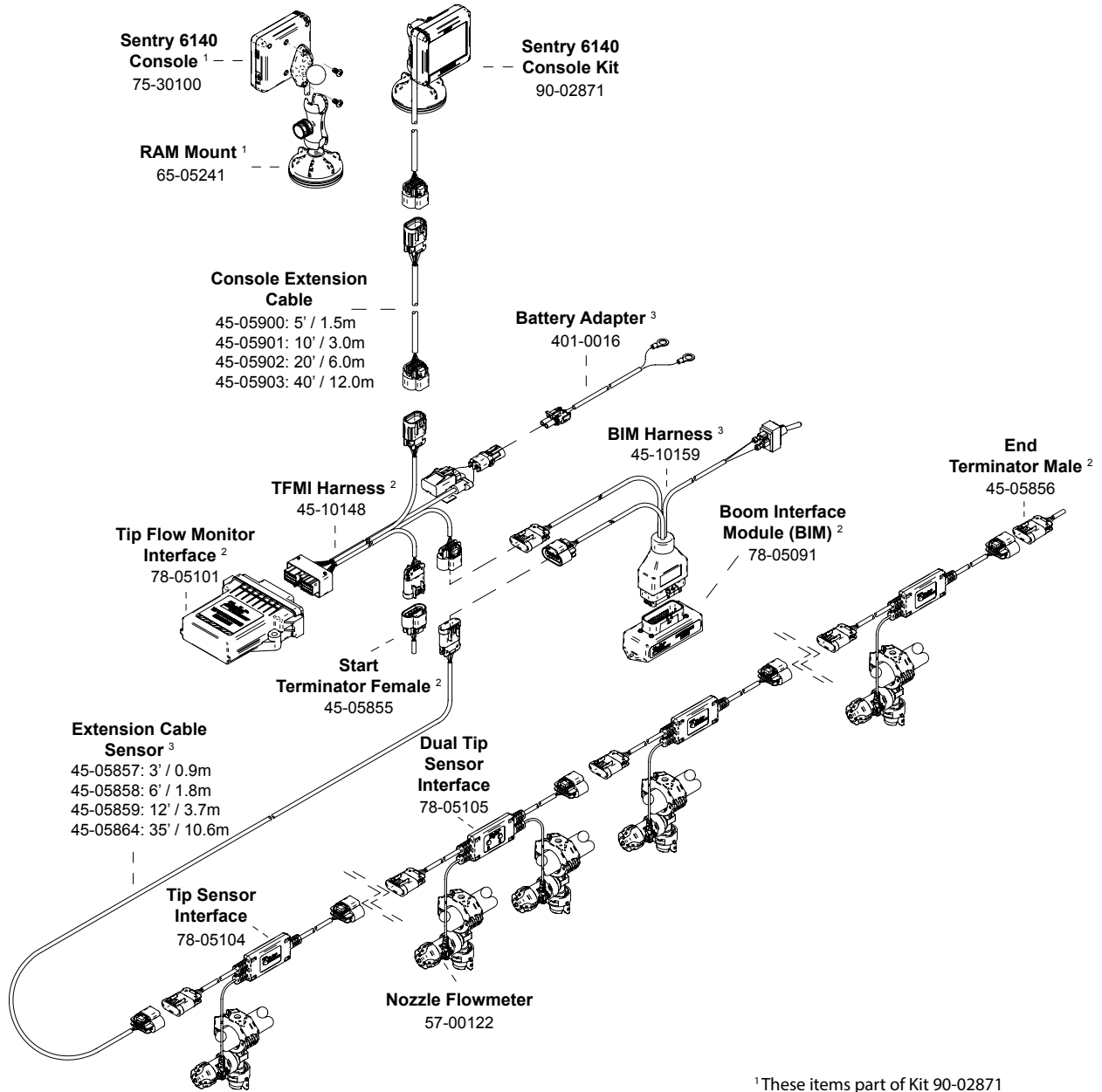

<sup>1</sup>These items part of Kit 90-02871

<sup>2</sup>These items part of Kit 90-02852

<sup>1,2,&3</sup>These items part of Kit 90-02889

# SENTRY 6140 TIP FLOW MONITOR

PART NO.	DESCRIPTION	U.S. DOLLARS
<b>STEP 1: CHOOSE A SENTRY 6140 BASIC KIT</b>		
90-02860	Kit, Basic Sentry 6140, Multiple Sections (1-15) Includes: Sentry Console Kit, Tip Flow Monitor Kit, Boom Sense 1-15 Harness, Power Cable Supports: Sprayers and Fertilizer Applicators with Multiple Boom Section Valves (See Items 1, 2, & 3 in System Diagrams) .....	\$ 2,071.42
90-02889	Kit, Basic Sentry 6140, Single Section Includes: Sentry Console Kit, Tip Flow Monitor Kit, Boom Sense Single Harness, Power cable Supports: Fertilizer Applicators and Planters with Single or No Boom Section Valves (See Items 1, 2, & 3 in System Diagrams) (See Items 1, 2, & 3 in System Diagrams) .....	1,918.01
<b>STEP 2: CHOOSE TIP SENSOR KIT</b>		
90-02861	Kit, Dual Flow Sensor Includes: (2) FlowMeters and (1) Dual Tip Sensor Interface .....	\$ 583.10
90-02861-PTC-250	Kit, Dual Flow Sensor Assembly, with PTC 1/4" FM. ....	583.10
90-02861-PTC-312	Kit, Dual Flow Sensor Assembly, with PTC 5/16" FM. ....	583.10
90-02861-PTC-375	Kit, Dual Flow Sensor Assembly, with PTC 3/8" FM. ....	583.10
90-02862	Kit, Single Flow Sensor Includes: (1) FlowMeter and (1) Single Tip Sensor Interface .....	368.28
90-02862-PTC-250	Kit, Single Flow Sensor Assembly, with PTC 1/4" FM .....	368.28
90-02862-PTC-312	Kit, Single Flow Sensor Assembly, with PTC 5/16" FM.....	368.28
90-02862-PTC-375	Kit, Single Flow Sensor Assembly, with PTC 3/8" FM.....	368.28
90-02902	Kit, Single Flow Sensor with 50" Sensor Lead .....	445.01
90-02902-PTC-250	Kit, Single Flow Sensor Assembly, with 50" Sensor, with PTC 1/4" FM.....	445.01
90-02902-PTC-312	Kit, Single Flow Sensor Assembly, with 50" Sensor, with PTC 5/16" FM. ....	445.01
90-02902-PTC-375	Kit, Single Flow Sensor Assembly, with 50" Sensor, with PTC 3/8" FM.....	445.01
90-02903	Kit, Double Flow Sensor with 50" Sensor Leads .....	621.75
90-02903-PTC-250	Kit, Dual Flow Sensor Assembly, with 50" Sensors, with PTC 1/4" FM. ....	621.75
90-02903-PTC-312	Kit, Dual Flow Sensor Assembly, with 50" Sensors, with PTC 5/16" FM.....	621.75
90-02903-PTC-375	Kit, Dual Flow Sensor Assembly, with 50" Sensors, with PTC 3/8" FM. ....	621.75
<b>STEP 3: CHOOSE EXT. CABLES</b>		
45-05857	Cable, 3'/0.9 m Sensor Ext.....	\$ 92.12
45-05858	Cable, 6'/1.8 m Sensor Ext.....	99.79
45-05859	Cable, 12'/3.7 m Sensor Ext. ....	107.46
45-05864	Cable, 35'/10.6 m Sensor Ext. ....	230.20
45-05900	Cable, 5'/1.5 m Console Ext. ....	153.50
45-05901	Cable, 10'/3.0 m Console Ext. ....	172.69
45-05902	Cable, 20'/6.0 m ConsoleExt.....	222.54
45-05903	Cable, 40'/12.0 m Console Ext. ....	329.91
<b>STEP 4: COMPONENTS</b>		
90-02871	Kit, Sentry 6140 Console Includes: Console and RAM Mount .....	\$ 997.37
90-02852	Kit, Tip Flow Monitor Includes: Terminators (Male/Female), TFMI Harness, TFMI and BIM Interfaces .....	1,112.46
401-0016	Cable Power, 1 Lead, 2'/0.6m .....	84.80
45-05855	Terminator, Female.....	86.38
45-05856	Terminator, Male .....	86.38
45-10142	Harness, Boom Interface Module .....	398.97
45-10148	Harness, Tip Flow Monitor Interface.....	506.54
45-10153	Harness, BIM BS, Sentry 6140, Hagie STS-10, 2006-2009 .....	788.11
45-10159	Harness, BIM Single Boom Status, With Switch .....	263.61
45-10161	Harness, BIM, Hagie STS 2014/2015 .....	415.88
116260-250	Flowmeter assembly, Sentry PTC 6140, 1/4" .....	112.31
116260-312	Flowmeter assembly, Sentry PTC 6140, 5/16" .....	112.31
116260-375	Flowmeter assembly, Sentry PTC 6140, 3/8" .....	112.31
57-00122	FlowMeter Assy., Tip Flow .....	112.31
57-00123	Gasket, Tip FlowMeter .....	11.08
65-05241	Kit, Sentry Ram Mount with Suction Cup .....	42.47
75-30100	Console, Sentry 6140 Tip Flow Monitor .....	974.36
78-05091	Boom Interface Module .....	469.94
78-05101	Interface, Tip Flow Monitor .....	728.85
78-05104	Interface, Single Tip Sensor .....	276.24
78-05105	Interface, Dual Tip Sensor .....	363.92

# SENTRY 6140 TIP FLOW MONITOR

## SENTRY 6140 SYSTEM ORDERING EXAMPLES

### SYSTEM 1 12 Nozzles (Nozzles Behind Sprayer Tank)

Qty	PART NO.	DESCRIPTION	U.S. DOLLARS
1	90-02860	Kit, Basic Sentry 6140, Multiple Section (1-15) .....	\$ 2,071.42
6	90-02861	Kit, Dual Flow Sensor .....	3,498.60
2	45-05859	Cable, 12'/3.7m Sensor Ext. ....	214.92
1	45-05902	Cable, 20'/6.0m Console Ext. ....	222.54
	<b>Total</b>	.....	<b>\$ 6,007.48</b>

See Diagram: Sprayer and Application with Multiple Boom Section Valves

### SYSTEM 2 15 Nozzles (Fertilizer Applicator)

Qty	PART NO.	DESCRIPTION	U.S. DOLLARS
1	90-02889	Kit, Basic Sentry 6140, Single Section .....	\$ 1,918.01
7	90-02861	Kit, Dual Flow Sensor .....	4,081.70
1	90-02862	Kit, Single Flow Sensor .....	368.28
2	45-05859	Cable, 12'/3.7m Sensor Ext. ....	214.92
1	45-05864	Cable, 35'/10.6m Sensor Ext. ....	230.20
1	45-05902	Cable, 20'/6.0m Console Ext. ....	222.54
	<b>Total</b>	.....	<b>\$7,035.65</b>

See Diagram: Applicators and Planters with Single or No Boom Section Valves

### SYSTEM 3 24 Nozzles (24 Row Planter or Fertilizer Applicator)

Qty	PART NO.	DESCRIPTION	U.S. DOLLARS
1	90-02860	Kit, Basic Sentry 6140, Multiple Section (1-15) .....	\$ 2,071.42
12	90-02861	Kit, Dual Flow Sensor .....	6,997.20
2	45-05857	Cable, 3'/0.9m Sensor Ext. ....	184.24
2	45-05859	Cable, 12'/3.7m Sensor Ext. ....	214.92
1	45-05864	Cable, 35'/10.6m Sensor Ext. ....	230.20
1	45-05902	Cable, 20'/6.0m Console Ext. ....	222.54
	<b>Total</b>	.....	<b>\$9,920.52</b>

See Diagram: Sprayers and Applicators with Multiple Boom Section Valves

### SYSTEM 4 48 Nozzles (80'/24 m Boom, 20"/50 cm Spacing)

Qty	PART NO.	DESCRIPTION	U.S. DOLLARS
1	90-02860	Kit, Basic Sentry 6140, Multiple Section (1-15) .....	\$ 2,071.42
24	90-02861	Kit, Dual Flow Sensor .....	13,994.40
4	45-05857	Cable, 3'/0.9m Sensor Ext. ....	368.48
2	45-05859	Cable, 12'/3.7m Sensor Ext. ....	214.92
1	45-05902	Cable, 20'/6.0m Console Ext. ....	222.54
	<b>Total</b>	.....	<b>\$ 16,871.76</b>

See Diagram: Sprayers and Applicators with Multiple Boom Section Valves

### SYSTEM 5 96 Nozzles (120'/36 m Boom, 15"/35 cm Spacing)

Qty	PART NO.	DESCRIPTION	U.S. DOLLARS
1	90-02860	Kit, Basic Sentry 6140 Multiple Section (1-15) .....	\$ 2,071.42
48	90-02861	Kit, Dual Flow Sensor .....	27,988.80
4	45-05857	Cable, 3'/0.9m Sensor Ext. ....	368.48
2	45-05859	Cable, 12'/3.7m Sensor Ext. ....	214.92
1	45-05902	Cable, 20'/6.0m Console Ext. ....	222.54
	<b>Total</b>	.....	<b>\$ 30,866.16</b>

See Diagram: Sprayers and Applicators with Multiple Boom Section Valves

# SENTRY 6141 TIP FLOW MONITOR

FOR SPRAYERS AND APPLICATORS WITH MULTIPLE BOOM SECTIONS

MONITORS

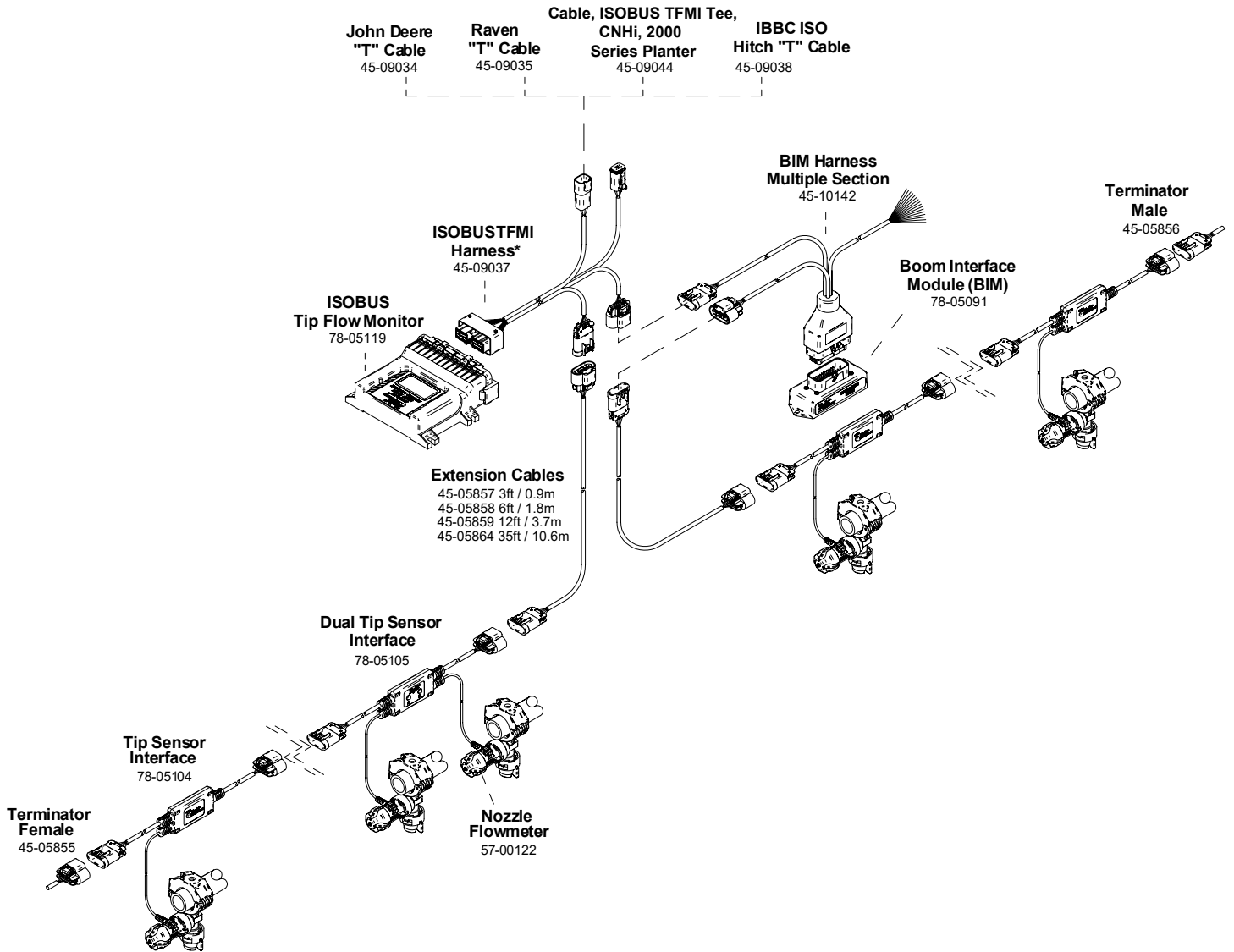

\*Can plug directly into existing ISOBUS 4 Pos DT Connectors if available

# SENTRY 6141 TIP FLOW MONITOR

FOR APPLICATORS AND PLANTERS WITH SINGLE BOOM SECTION

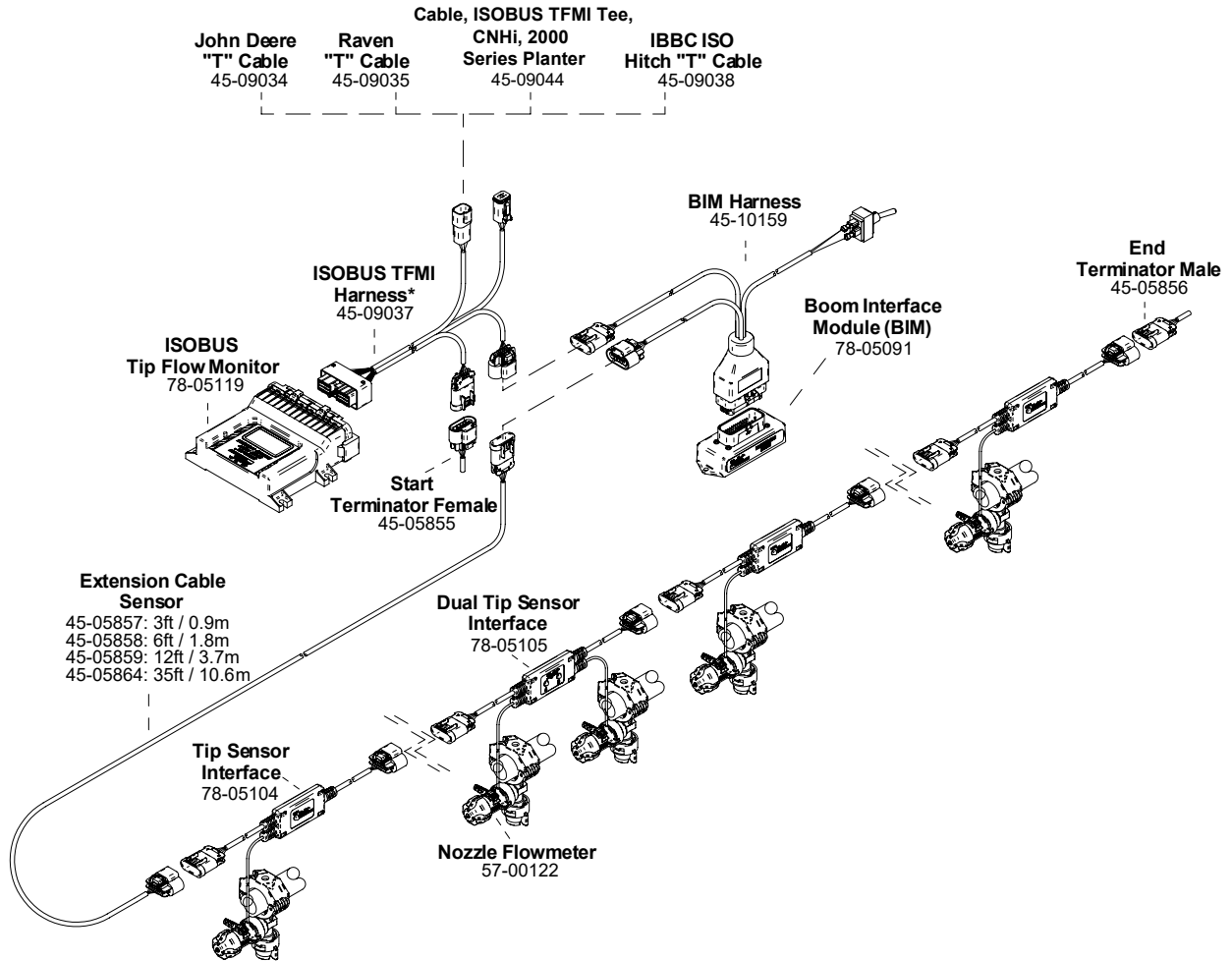

\*Can plug directly into existing ISOBUS 4 Pos DT Connectors if available

MONITORS



# SENTRY 6141 TIP FLOW MONITOR

MONITORS

PART NO.	DESCRIPTION	U.S. DOLLARS
<b>STEP 1: CHOOSE A SENTRY 6141 BASIC KIT</b>		
90-02907	Kit, Basic Sentry 6141, Multiple Sections (1-15) Includes: ISO Tip Flow Monitor Interface, ISO TFMI Harness, Boom Interface Module, Boom Sense 1-15 Harness, CAN Terminators .....	\$ 1,834.23
90-02906	Kit, Basic Sentry 6141, Single Section Includes: ISO Tip Flow Monitor Interface, ISO TFMI Harness, Boom Interface Module, Boom Sense Single Section, CAN Terminators .....	1,760.85
90-02934	Kit, Sentry 6141, CNHI, 2000 Series Planters Includes: ISO Tip Flow Monitor Interface, ISO TFMI Harness, CNHi 2000 Series Planter ISO TFMI Tee Cable (SKIP STEP 3), Boom Interface Module, CNHi 2000 Series Planter BIM harness, CAN Terminators .....	2,347.79
90-02941	Kit, Sentry 6141, CNHI 1200 Series Planters Includes: ISO Tip Flow Monitor Interface, ISO TFMI Harness, CNHi 1200 Series Planter ISO TFMI Tee Cable (SKIP STEP 3), Boom Interface Module, CNHi 1200 Series Planter BIM Harness, CAN terminators .....	2,347.79
<b>STEP 2: CHOOSE TIP SENSOR KIT</b>		
90-02861	Kit, Dual Flow Sensor Includes: (2) FlowMeters and (1) Dual Tip Sensor Interface .....	\$ 583.10
90-02861-PTC-250	Kit, Dual Flow Sensor Assembly, with PTC 1/4" FM. ....	583.10
90-02861-PTC-312	Kit, Dual Flow Sensor Assembly, with PTC 5/16" FM. ....	583.10
90-02861-PTC-375	Kit, Dual Flow Sensor Assembly, with PTC 3/8" FM. ....	583.10
90-02862	Kit, Single Flow Sensor Includes: (1) FlowMeter and (1) Single Tip Sensor Interface .....	368.28
90-02862-PTC-250	Kit, Single Flow Sensor Assembly, with PTC 5/16" .....	368.28
90-02862-PTC-312	Kit, Single Flow Sensor Assembly, with PTC 5/16" .....	368.28
90-02862-PTC-375	Kit, Single Flow Sensor Assembly, with PTC 3/8" .....	368.28
90-02902	Kit, Single Flow Sensor with 50" Sensor Lead. ....	445.01
90-02902-PTC-250	Kit, Single Flow Sensor Assembly, with 50" Sensor, with PTC 1/4" FM. ....	445.01
90-02902-PTC-312	Kit, Single Flow Sensor Assembly, with 50" Sensor, with PTC 5/16" FM. ....	445.01
90-02902-PTC-375	Kit, Single Flow Sensor Assembly, with 50" Sensor, with PTC 3/8" FM. ....	445.01
90-02903	Kit, Double Flow Sensor with 50" Sensor Leads .....	621.75
90-02903-PTC-250	Kit, Dual Flow Sensor Assembly, with 50" Sensors, with PTC 1/4" FM. ....	621.75
90-02903-PTC-312	Kit, Dual Flow Sensor Assembly, with 50" Sensors, with PTC 5/16" FM. ....	621.75
90-02903-PTC-375	Kit, Dual Flow Sensor Assembly, with 50" Sensors, with PTC 3/8" FM. ....	621.75
<b>STEP 3: CHOOSE ISOBUS CONNECTION CABLE</b>		
45-09034	Cable, ISOBUS TFMI Tee, John Deere ISOBUS Planter, 12 Pos .....	\$ 293.49
45-09035	Cable, ISOBUS TFMI Tee, Raven .....	293.49
45-09038	Cable, ISOBUS TFMI Tee, IBBC ISO Hitch .....	293.49
45-09044	Cable, ISOBUS TFMI Tee, CNHi, 2000 Series Planter (Included in 90-02934 Kit) .....	293.49
45-09045	Cable, ISOBUS TFMI Tee, CNHi, 1200 Series Planter (Included in 90-02941 Kit) .....	293.49
<b>STEP 4: CHOOSE EXTENSION CABLES</b>		
45-05857	Cable, 3'/0.9m Sensor Extension .....	\$ 92.12
45-05858	Cable, Sensor Bus Extension, 6' .....	99.79
45-05859	Cable, 12'/3.7m Sensor Extension .....	107.46
45-05864	Cable, 35'/10.6m Sensor Extension .....	230.20
<b>COMPONENTS</b>		
45-05855	Terminator, Female .....	\$ 86.38
45-05856	Terminator, Male .....	86.38
45-10142	Harness, BIM Multiple Sections (1-15) .....	398.97
45-09037	Harness, ISOBUS Tip Flow Monitor Interface .....	359.23
45-10159	Harness, BIM Single Boom Status, With Switch. ....	263.61
57-00122	Flowmeter Assy., Tip Flow. ....	112.31
116260-250	Flowmeter assembly, Sentry PTC 6140, 1/4" .....	112.31
116260-312	Flowmeter assembly, Sentry PTC 6140, 5/16" .....	112.31
116260-375	Flowmeter assembly, Sentry PTC 6140, 3/8" .....	112.31
57-00123	Gasket, Tip Flow Meter. ....	11.08
78-05091	Boom Interface Module. ....	469.94
78-05104	Interface, Single Tip Sensor .....	276.24
78-05105	Interface, Dual Tip Sensor. ....	363.92
78-05117	Interface, Tip Sensor, with 50 in/127 cm Sensor Leads .....	357.79
78-05118	Interface, Dual Tip Sensor, with 50 in/127 cm Sensor Leads .....	436.09

# SENTRY 6141 TIP FLOW MONITOR

PART NO.	DESCRIPTION	U.S. DOLLARS
<b>SENTRY 6141 SYSTEM ORDERING EXAMPLES</b>		
<b>SYSTEM 1</b>	<b>24 Nozzles (24 row 30"/76 cm Spacing CNHi 2000 Series Planter with Universal Terminal)</b>	
<b>Qty</b>		
1	90-02934 Kit, Sentry 6141, CNHi, 2000 Series Planter .....	\$ 2,347.79
12	90-02861-PTC-250 Kit, Dual Flow Sensor Assembly with PTC 1/4" FM .....	6,997.20
2	45-05859 Cable, 12' Sensor Extension. ....	214.92
2	45-05857 Cable, 3' Sensor Extension. ....	184.24
	<b>Total</b> .....	<b>\$9,744.15</b>
<b>SYSTEM 2</b>	<b>36 Nozzles (36 row 30"/76 cm John Deere planter with UT)</b>	
<b>Qty</b>		
1	90-02907 Kit, Basic Sentry 6141, Multiple Sections .....	\$ 1,834.23
18	90-02861 Kit, Dual Flow Sensor. ....	10,495.80
1	45-09034 Cable, ISOBUS TFMI Tee, John Deere ISOBUS Planter, 12 Pos .....	293.49
2	45-05858 Cable, 6' Sensor Extension. ....	199.58
2	45-05857 Cable, 3' Sensor Extension. ....	184.24
	<b>Total</b> .....	<b>\$13,007.34</b>
<b>SYSTEM 3</b>	<b>15 Nozzles (15 row 30"/76 cm Fertilizer Applicator, Connecting to IBBC on ISOBUS Ready tractor)</b>	
<b>Qty</b>		
1	90-02907 Kit, Basic Sentry 6141, Multiple Section .....	\$ 1,834.23
7	90-02861 Kit, Dual Flow Sensor. ....	4,081.70
1	90-02862 Kit, Single Flow Sensor .....	368.28
1	45-09038 Cable, ISOBUS TFMI TEE, IBBC ISO HITCH .....	293.49
2	45-05857 Cable, 3' Sensor Extension. ....	184.24
1	45-05864 Cable, 35' Sensor Extension. ....	230.20
	<b>Total</b> .....	<b>\$6,992.14</b>
<b>SYSTEM 4</b>	<b>16 Nozzles (16 row 30"/76 cm Spacing AGCO White Planter with UT)</b>	
<b>Qty</b>		
1	90-02907 Kit, Basic Sentry 6141, Multiple Section .....	\$ 1,834.23
8	90-02861 Kit, Dual Flow Sensor. ....	4,664.80
1	45-09038 Cable, ISOBUS TFMI TEE, IBBC ISO HITCH .....	293.49
2	45-05859 Cable, 12' Sensor Extension. ....	214.92
2	45-05857 Cable, 3' Sensor Extension. ....	184.24
	<b>Total</b> .....	<b>\$7,191.68</b>

MONITORS



# APPLICATION CONTROLS

MANUAL AND AUTOMATIC SPRAYER CONTROLS-  
ISOBUS APPLICATION CONTROLS

# 744E/744A SPRAYER CONTROLS



The 744 family of Sprayer Controls is perfect for converting a variety of sprayers from manual valves to electric ball valves. The 744 is available as a complete kit equipped with a back-lit pressure gauge, active boom section LED indicator, and cable kit.

The 430 Ball Valve Manifold is an ideal match for the 744E and is available with a wide variety of inlet and outlet fittings to work perfectly with your sprayer.

## BALL VALVE SYSTEM DIAGRAM

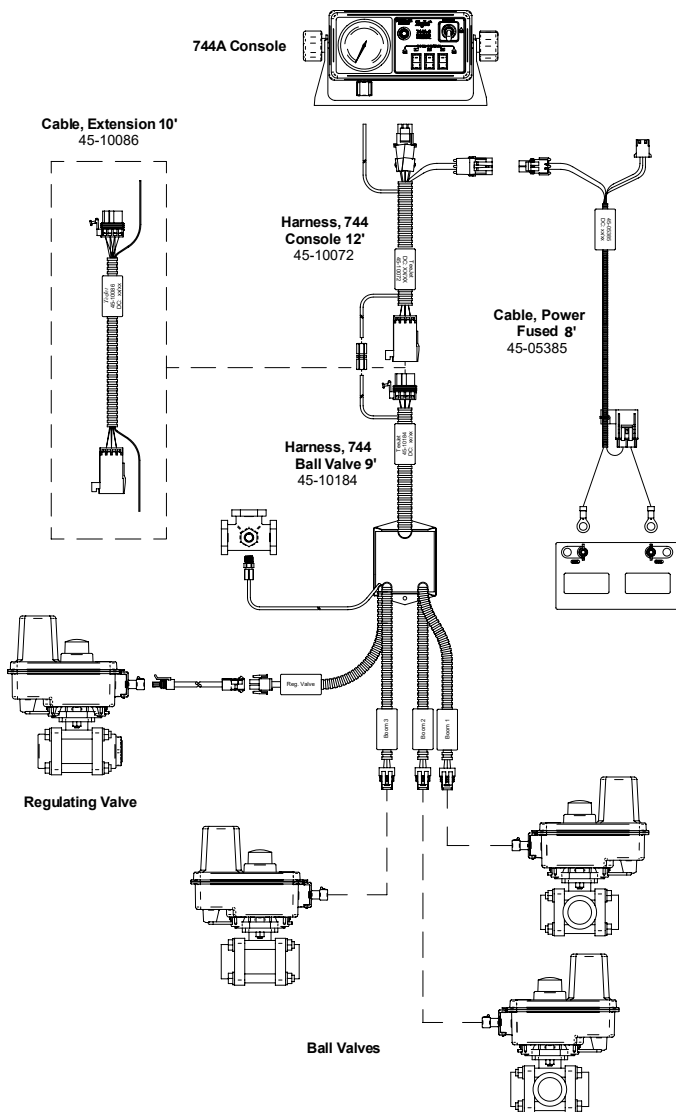

## SOLENOID VALVE SYSTEM DIAGRAM

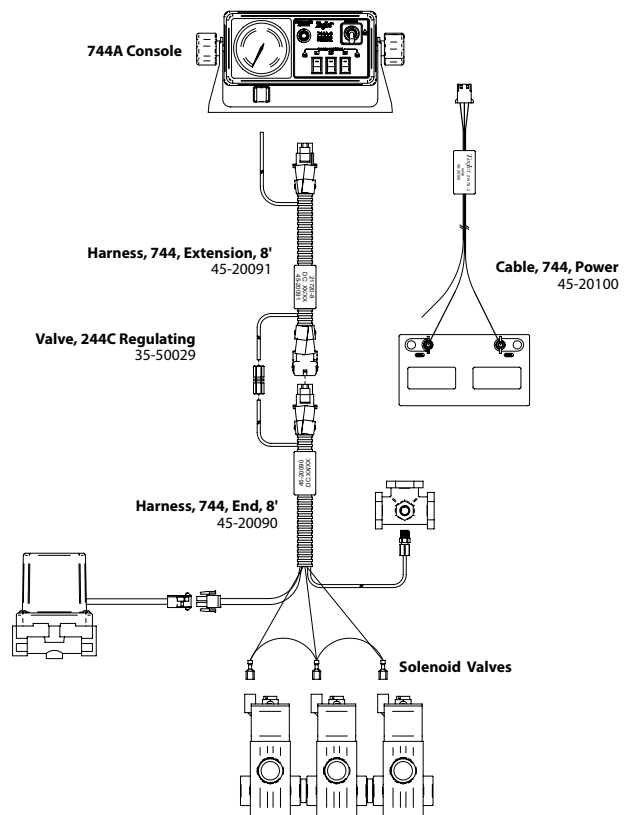

APPLICATION CONTROLS

# 744 MANUAL SPRAYER CONTROL KITS

APPLICATION CONTROLS

PART NO.	DESCRIPTION	U.S. DOLLARS
<b>3 &amp; 5 SECTION 744 CORE KITS (NO IMPLEMENT CABLES)</b>		
90-50239	Kit, 744A, 3 Boom 100 PSI, No Cables .....	\$ 405.81
90-50289	Kit, 744A, 3 Boom 100 PSI, Power Cable .....	418.44
90-50290	Kit, 744A, 3 Boom 300 PSI, Power Cable .....	418.44
90-50291	Kit, 744E, 5 Boom 100 PSI, Power Cable .....	646.12
90-50292	Kit, 744E, 5 Boom 300 PSI, Power Cable .....	646.12
<b>3 SECTION 744 (100 PSI) SOLENOID KITS</b>		
90-50149	Kit, 744A, 3 Boom 100 PSI, Solenoid Cables .....	\$ 462.05
90-50161	Kit, 744A, 3 Boom 100 PSI, Solenoid Cables, w/244C 3/4 Reg Valve .....	567.87
90-50163	Kit, 744A, 3 Boom 100 PSI, Solenoid Cables, w/244C 3/4 Reg Valve & 144A-3 .....	910.31
90-50177	Kit, 744A, 3 Boom 100 PSI, Solenoid Cables, w/244C 3/4 Reg Valve & 144P-3 .....	1,228.89
<b>3 SECTION 744 (100 PSI) BALL VALVE KITS</b>		
90-02439-MP	Kit, 744A, 3 Boom 100 PSI, Metri-Pack Ball Valve Harness .....	\$ 685.84
90-02439-MD	Kit, 744A, 3 Boom 100 PSI, MINI-DIN Ball Valve Harness .....	685.84
90-02439-UX	Kit, 744A, 3 Boom 100 PSI, 4 POS WP Valve Harness .....	685.84
90-50254	Kit, 744E, 3-Boom 100 PSI, w/ 430 DIN Harness .....	989.62
<b>3 SECTION 744 (300 PSI) BALL VALVE KITS</b>		
90-50151-MD	Kit, 744A, 3 Boom 300 PSI, MINI-DIN Harness .....	\$ 705.29
90-50151-MP	Kit, 744A, 3 Boom 300 PSI, Metri-Pack Harness .....	705.29
90-50151-UX	Kit, 744A, 3 Boom 300 PSI, 4 POS WP Harness .....	705.29
90-50280	Kit, 744E, 3 Boom 300 PSI, W/430 DIN Harness .....	989.62
<b>5 SECTION 744 (100 PSI) BALL VALVE KITS</b>		
90-50255-MD	Kit, 744E, 5 Boom 100 PSI, MINI-DIN Harness, No Valves .....	\$ 1,117.36
90-50255-MP	Kit, 744E, 5 Boom 100 PSI, Metri-Pack Harness, No Valves .....	1,117.36
90-50255-UX	Kit, 744E, 5 Boom 100 PSI, 4 POS WP Harness, No Valves .....	1,117.36
90-50276	Kit, 744E, 5 Boom 100 PSI, w/430 DIN+MSTR Harness .....	1,214.18
<b>5 SECTION 744 (300 PSI) BALL VALVE KITS</b>		
90-50281-MD	Kit, 744E, 5 Boom 300 PSI, MINI-DIN Harness, No Valves .....	\$ 1,117.36
90-50281-MP	Kit, 744E, 5 Boom 300 PSI, Metri-Pack Harness, No Valves .....	1,117.36
90-50281-UX	Kit, 744E, 5 Boom 300 PSI, 4 POS WP Harness, No Valves .....	1,117.36



# 744 MANUAL SPRAYER CONTROLS WITH BALL VALVE CABLING

	3 SECTION 744A CONSOLE		5 SECTION 744E CONSOLE		3 SECTION TEEJET BALL VALVE CABLING			5 SECTION TEEJET BALL VALVE CABLING			BOOM SECTION VALVES	U.S.DOLLARS
	100 PSI	300 PSI	100 PSI	300 PSI	430EC VALVES (Mini-DIN)	BEC VALVES (Metri-Pack)	BEC VALVES (Weather Pack)	430EC VALVES (Mini-DIN)	BEC VALVES (Metri- Pack)	BEC VALVES (Weather Pack)		
<b>CABLES</b>												
<b>744 KITS</b>	75-50033	75-50035	75-50061	75-50069	45-05385 45-10072 45-10185	45-05385 45-10072 45-10184	45-05385 45-10072 45-10080	45-05385 45-10197	45-05385 45-10198	45-05385 45-10199	NONE	
90-02439-XX*	X				MD	MP	UX**				X	\$ 685.84
90-50151-XX*		X			MD	MP	UX**				X	705.29
90-50255-XX*			X					MD	MP	UX**	X	1,117.36
90-50281-XX*				X				MD	MP	UX**	X	1,117.36

\* Specify MP, MD or UX in part number to select the proper cable to fit your valves. Refer to above chart.

\*\* When ordering shutoff valves to connect to this cable, specify VX connector code.

# 744 MANUAL SPRAYER CONTROLS WITH SOLENOID CABLING

	744A 3-SWITCH	BOOM VALVE CABLING	BOOM SECTION VALVES			REGULATING VALVES	U.S. DOLLARS
	100 PSI CONSOLE	SOLENOID CABLING	NONE	144A-3	144P-3	244C BUTTERFLY	
	75-50033	45-20090 45-20091 45-20100		35-50023 AA144A-3	35-50027 AA144P-3	35-50029	
90-50149	X	X	X				\$ 462.05
90-50161	X	X	X			X	567.87
90-50163	X	X		X		X	910.31
90-50177	X	X			X	X	1,228.89

## CONSOLES

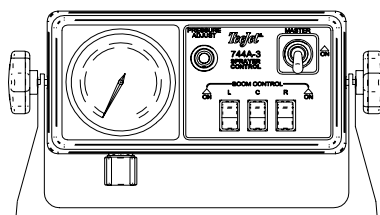

744A

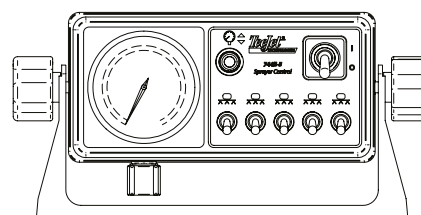

744E

# 744 MANUAL SPRAYER CONTROLS WITH BALL VALVE CABLING

APPLICATION CONTROLS

PART NO.	DESCRIPTION	U.S. DOLLARS
<b>744 MANUAL SPRAYER CONTROL SYSTEM ORDERING INFORMATION*</b>		
STEP 1:	CHOOSE 744 CORE KIT	
90-50289	Kit, 3 Section 744A, 100 PSI, Power Cable .....	<b>\$ 418.44</b>
90-50290	Kit, 3 Section 744A, 300 PSI, Power Cable .....	<b>418.44</b>
90-50291	Kit, 5 Section 744E, 100 PSI, Power Cable .....	<b>646.12</b>
90-50292	Kit, 5 Section 744E, 300 PSI, Power Cable .....	<b>646.12</b>
STEP 2:	CHOOSE CONSOLE HARNESS	
45-10072	Harness, 3 Section 744A, Console, Ball Valves, 12' (Required) .....	<b>172.95</b>
45-10196	Harness, 5 Section 744E, Console, Ball Valves, 10' (Optional) .....	<b>254.46</b>
STEP 3:	CHOOSE IMPLEMENT HARNESS	
45-10080	Harness, 3 Section 744A, Implement, Ball Valves, 4 Pos WP .....	<b>389.72</b>
45-10184	Harness, 3 Section 744A, Implement, Ball Valves, MetriPack (B Valves) .....	<b>389.72</b>
45-10185	Harness, 3 Section 744A, Implement, Ball Valves, Mini-Din (430 Valves) .....	<b>389.72</b>
45-10197	Harness, 5 Section 744E, Implement, Ball Valves, Mini-Din (430 Valves) .....	<b>800.49</b>
45-10198	Harness, 5 Section 744E, Implement, Ball Valves, MetriPack (B Valves) .....	<b>800.49</b>
45-10199	Harness, 5 Section 744E, Implement, Ball Valves, 4 Pos WP .....	<b>800.49</b>
STEP 4:	CHOOSE REGULATING VALVE	
35-02115	Valve, Reg, 344BPR, 3/4" .....	<b>349.23</b>
35-02087	Valve, Reg, 344BRL, 1" .....	<b>362.91</b>
35-02099	1" NPT, 2 way, 344 BRL Valve, 27 GPM .....	<b>362.91</b>
35-02090	1-1/2" NPT, 2 way, 346 BR Valve, 100 GPM .....	<b>742.04</b>
35-02112	50 Series Flange, 2 way, 344BRL, 27 GPM .....	<b>362.91</b>
STEP 5:	CHOOSE OPTIONAL CABLES AND COMPONENTS	
	Extension Cables	
45-10086	Cable, 744A 3 Section Ball Valve Extension, 10' .....	<b>112.97</b>
45-10196	Harness, 5 Section 744E, Console, Ball valves, 10' .....	<b>254.46</b>
	Adapter Cables	
45-04029	Cable, Adapter, DIN To Reg Valve, 12", Reverse Polarity .....	<b>46.77</b>
45-05930	Cable, Adapter, DIN to Reg Valve, 12" .....	<b>46.77</b>
45-04036	Cable, Adapter, Reverse Polarity Reg. Valve, 6" .....	<b>38.60</b>
45-04016	Cable, Raven Reg Valve Adapter .....	<b>25.70</b>

\* For use when specific parts are desired that are not available in the existing list of 744 kits.

# 70 SERIES

The 70 series offer a range of monitoring and control functions. The compact enclosure is equipped with four buttons and an LCD display. It can be mounted in any position and is designed to be rugged and dependable.



# 70 SERIES

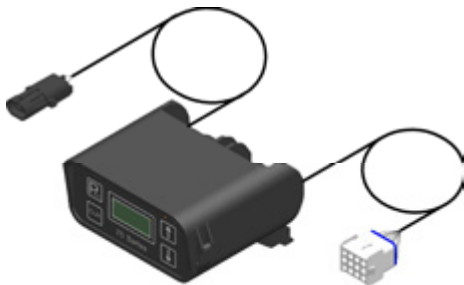

75-30010  
75-30013  
75-30015  
75-30020



45-05450



16-40004

PART NO.	DESCRIPTION	U.S. DOLLARS
<b>KITS</b>		
90-02255	Kit, 70 Series Speed/Area/Distance .....	\$ 863.08
90-02584	Kit, 70 Series Speed/Area/Distance w/ GPS Speed Sensor .	1,468.97
90-02303	Kit, 70 Series Flow Monitor .....	831.45
90-02328	Kit, 70 Series Single RPM .....	949.23
90-02334	Kit, 70 Series Dual RPM .....	992.67

## ACCESSORIES

75-30010	70 Series Speed/Area/Distance Console .....	\$ 674.64
75-30013	70 Series Flow Monitor Console .....	708.38
75-30015	70 Series Single RPM Console .....	708.38
45-05429	70 Series Single sensor Cable .....	155.26
45-05439	70 Series Flow sensor Cable .....	155.26
45-05450	70 Series Dual RPM Cable .....	218.70
45-05905	70 Series Power Cable .....	99.25
16-40004	Proximity Speed sensor .....	147.24

## FEATURES

90-02255:  
Complete kit includes monitor, speed sensor and cable.

90-02328, 90-02334:  
Complete kit includes monitor, RPM sensor and cable.

90-02303:  
Kit includes monitor and cable. Kit does not include flowmeter so it needs to be ordered separately.

# TEEJET 845 & 845-AB

The TeeJet 845 & 845-AB Sprayer Control offers spraying advantages not found in other controllers. Designed with simplicity in mind, computer-controlled spraying has never been so easy. Simply set your target application rate and the unique VisiFlo display on the 845 & 845-AB with the newly updated display and hardware helps select the right TeeJet tip for your spraying application. Once spraying begins, the large display shows application rate, volume sprayed, system pressure, sprayer speed, and area covered, all the spraying information you need.



APPLICATION CONTROLS

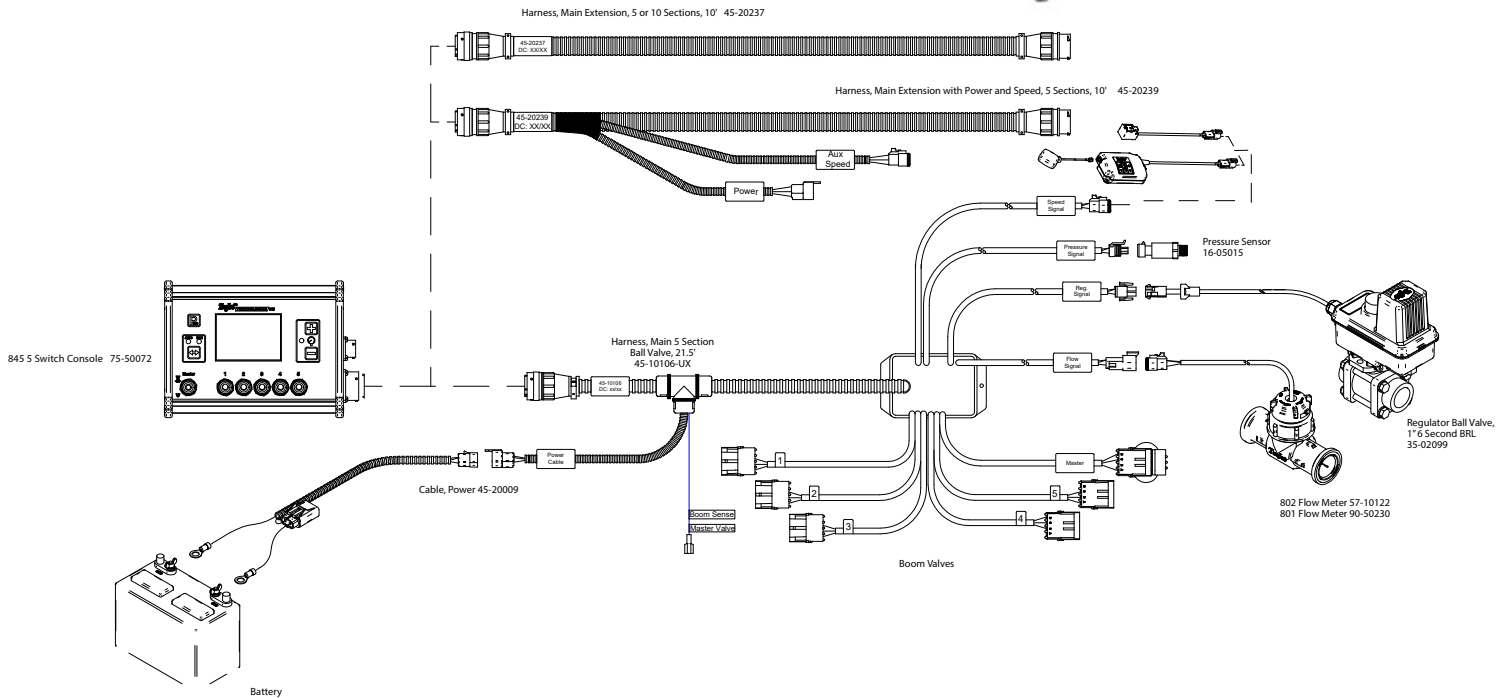

## AUTOMATIC SPRAYER CONTROLS

PART NO. DESCRIPTION U.S. DOLLARS

### 845 SPRAYER CONTROL KITS

90-50268	Kit, 845, Mounting Bracket, 12' PWR Cable, User Guide...	\$ 1,721.11
90-50143	Kit, 845, Mounting Bracket, No Cables, User Guide.....	1,649.18
75-50072	Console, 845.....	1,538.53

### 845-AB SPRAYER CONTROL KITS

90-50300	Kit, 845-AB, Mounting Bracket, Power Cable, User Guide....	\$ 2,273.60
90-50252	Kit, 845-AB, W/o Cables.....	2,196.74
75-50075	Console, 845-AB, 4 Sections.....	2,103.87



### 834-P SPRAYER CONTROL KITS

90-50225	Kit, 834-P (Includes Console, Mounting Brackets, Cables, Booster Module, Pressure Sensor, Proximity Sensor and Manual.....)	\$2,625.32
90-02585	Kit, 834-P (Includes Console, Mounting Brackets, Cables, Booster Module, Pressure Sensor, GPS Speed and Manual.....)	3,220.31

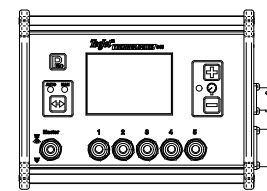

845 Sprayer Control

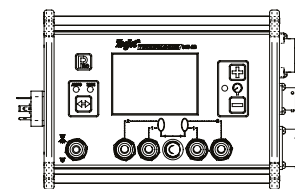

845-AB Sprayer Control

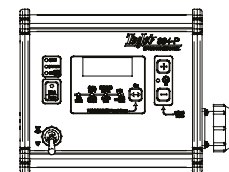

834-P Sprayer Control

# RADION 8140

Radion is an automatic sprayer controller with a touch-screen, built-in planning tool, automatically displays the available speed range for the target rate and spray tip that have been selected. This unique visual planning tool makes choosing the correct spray nozzle for an application a quick and simple task.

Radion is available as an individual controller, or in a complete package with the valves, cables, and sensors needed to put together a total sprayer control system.



## RADION 8140 AUTOMATIC SPRAYER CONTROL

APPLICATION CONTROLS

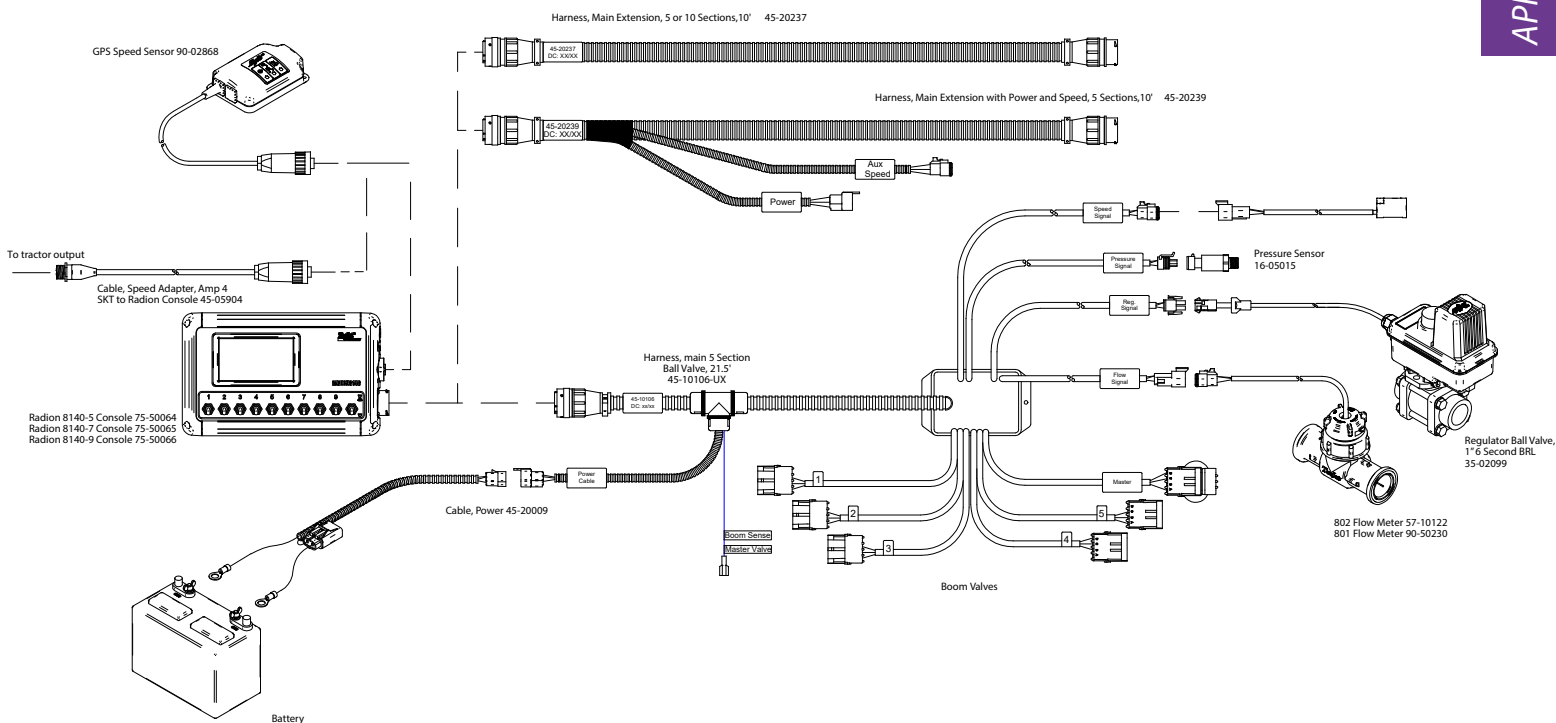

### RADION SPRAYER CONTROL KITS

PART NO.	DESCRIPTION	U.S. DOLLARS
90-50259	Kit, Radion 8140-5, RAM Mount, 12' PWR Cable, User Guide	\$ 3,623.47
90-50263	Kit, Radion 8140-7, RAM Mount, No PWR Cable, User Guide	3,625.99
90-50265	Kit, Radion 8140-9, RAM Mount, No PWR Cable, User Guide	3,810.52
75-50064	Console, Radion 8140-5	3,314.55
75-50065	Console, Radion 8140-7	3,497.37
75-50066	Console, Radion 8140-9	3,681.85

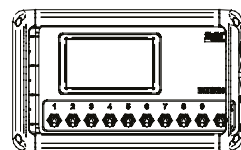

Radion 8140 Sprayer

# AUTOMATIC SPRAYER CONTROLS

APPLICATION CONTROLS

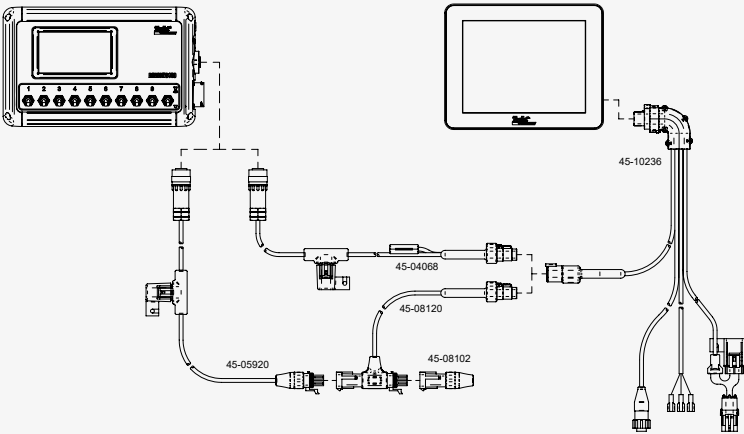
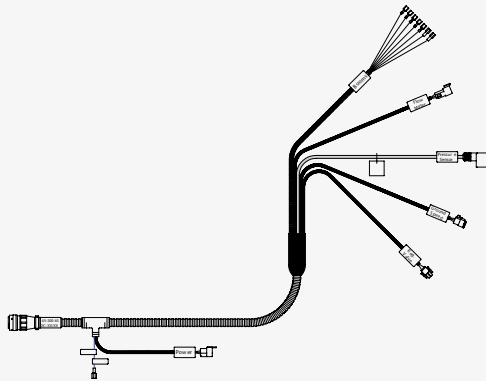
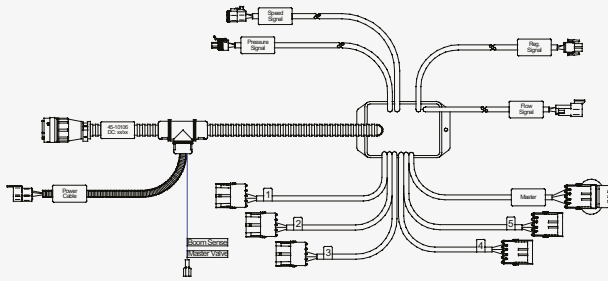
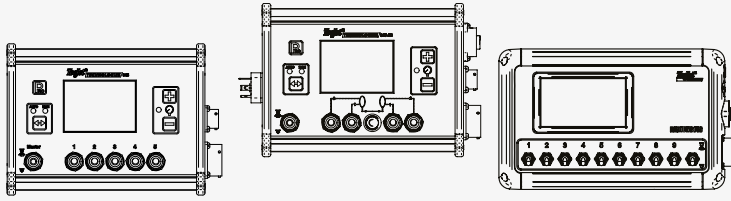

PART NO.	DESCRIPTION	U.S. DOLLARS
<b>Step 1:</b>		
<b>CHOOSE RADION 8140/845 KIT</b>		
90-50259	Kit, 5-Section Radion 8140, Ram Mount, 12' Power Cable, User Guide. ....	\$ 3,623.47
90-50263	Kit, 7-Section Radion 8140, Ram Mount, User Guide	3,625.99
90-50265	Kit, 9-Section Radion 8140, Ram Mount, User Guide	3,810.52
90-50268	Kit, 845, Mounting Bracket, 12' Power Cable, User Guide	1,721.11
90-50300	Kit, 845AB-4, Mounting Bracket, Power Cable, User Guide	2,273.60
<b>Step 2:</b>		
<b>CHOOSE MAIN HARNESS</b>		
45-20065	Harness, 5 section Solenoid, 26', Faston.....	\$ 679.69
45-20066	Harness, 5 section Solenoid, 17', Faston.....	628.86
45-10106-UX	Harness, 5 section Ball Valves, 21.5', 4 POS WP.....	1,322.24
45-10106-MD	Harness, 5 section Ball Valves, 21.5', Mini-Din. ....	1,322.24
45-10106-OG	Harness, 5 section Ball Valves, 21.5', 3 POS WP. ....	1,322.24
45-10106-PC	Harness, 5 section Ball Valves, 21.5', 3 POS WP. ....	1,322.24
45-10106-MP	Harness, 5 section Ball Valves, 21.5', 3 POS Metri-Pak .	1,322.24
45-10152-UX	Harness, 9 section Ball Valves, 9.5', 4 POS WP. ....	1,544.01
*Required	45-10050 Harness, 9.8' Ext. W/ 14' BAT PWR, 10 Section	669.57
45-10152-MD	Harness, 9 section Ball Valves, 9.5', Mini-Din.....	1,544.01
*Required	45-10050 Harness, 9.8' Ext. w/ 14' BAT PWR, 10 Section	669.57
45-10152-OG	Harness, 9 section Ball Valves, 9.5', 3 POS WP. ....	1,544.01
*Required	45-10050 Harness, 9.8' Ext. w/ 14' BAT PWR, 10 Section	669.57
45-10152-PC	Harness, 9 section Ball Valves, 9.5', 3 POS WP. ....	1,544.01
*Required	45-10050 Harness, 9.8' Ext. w/ 14' BAT PWR, 10 Section	669.57
45-10152-MP	Harness, 9 section Ball Valves, 9.5', 3 POS Metri-Pak...	1,544.01
*Required	45-10050 Harness, 9.8' Ext. w/ 14' BAT PWR, 10 Section	669.57
<b>Step 3:</b>		
<b>CHOOSE GROUND SPEED</b>		
90-02868	Kit, GPS Speed Sensor for Radion Console.....	\$ 742.23
90-02386	Kit, GPS Speed Sensor for 844E/ 845 Console.....	742.23
16-40004	Sensor, Proximity Speed.....	147.24
<b>Step 4:</b>		
<b>CHOOSE REGULATING VALVE</b>		
35-02099	1" NPT, 2 Way, 344 BRL Valve, 27 GPM. ....	\$ 362.91
35-02090	1-1/2" NPT, 2 Way, 346 BR Valve, 100 GPM.....	742.04
35-02112	50 Series Flange, 2 Way, 344 BRL, 27 GPM.....	362.91
<b>Step 5:</b>		
<b>CHOOSE FLOWMETER</b>		
90-50230	801 FlowMeter, 1" HB, 2-45 GPM.....	\$ 713.55
90-50231	801 FlowMeter, 3/4" HB, 2-45 GPM.....	713.55
90-50232	801 FlowMeter, 1-1/4" HB, 2-45 GPM.....	713.55
57-10100	801 FlowMeter, 50 Series Flange, 2-45 GPM.....	694.95
57-10122	802 FlowMeter, 75 Series Flange, 3-130 GPM.....	759.55
<b>Step 6:</b>		
<b>CHOOSE OPTIONAL CABLES &amp; COMPONENTS</b>		
<u>CAN/Speed Unlock for Radion 8140</u>		
98-50143	Unlock Code, ABSC, For Radion Console.....	\$ 1,151.58
45-04068	Cable, Radion CAN To M908, 6 POS DTM w/ Term 7' ..	226.70
45-05914	Cable, Radion CAN To Matrix, 5'.....	273.50
45-05920	Cable, Radion CAN To TeeJet CAN, 4 POS. WP.....	189.92
45-05925	Cable, Radion, CAN, to Matrix 10'.....	312.14
45-08120	Cable, CAN TEE to DTM, 6'.....	170.23
<u>Pressure Transducers</u>		
16-05015	Sensor Pressure, 0-145 PSI/ 0-10 BAR.....	\$ 345.02
16-05016	Sensor Pressure, 0-363 PSI/ 0-25 BAR.....	352.80
<u>Ext. Cables</u>		
45-20239	Cable, 10' Ext. w/ PWR and speed Leads, 5 Section ...	\$ 520.19
45-20237	Cable, 10' Ext., 5 or 10 Section.....	685.98





# AUTOMATIC SPRAYER CONTROLS

PART NO.	DESCRIPTION	U.S. DOLLARS
<b>RATE CONTROL ORDERING EXAMPLES</b>		
<b>845 RATE CONTROL SYSTEM WITH BALL VALVES</b>		
<b>EXAMPLE:</b>		
90-50268	Kit, 845, Mounting Bracket, PWR Cable, User Guide .....	\$ 1,721.11
45-10106-MD	Harness, 5 Sect. Ball Valves, MINI-DIN .....	1,322.24
90-02386	Kit, GPS Speed Sensor for TeeJet Controls .....	742.23
35-02099	Valve, 1", 3 RPM .....	362.91
90-50230	Kit, 801 Flowmeter, w/ 1" Hose Barbs .....	713.55
435EC-2-D*	430EC-2 Manifold* .....	1,515.88
	<b>Total</b> .....	<b>\$ 6,377.92</b>
<b>RADION 8140 RATE CONTROL SYSTEM WITH BALL VALVES</b>		
<b>EXAMPLE:</b>		
90-50259	Kit, Radion 8140-5, RAM Mount, PWR Cable, User Guide .....	\$ 3,623.47
45-10106-MD	Harness, 5 Sect. Ball Valves, MINI-DIN .....	1,322.24
90-02868	Kit, GPS Speed Sensor for Radion Controls .....	742.23
35-02099	Valve, 1", 3 RPM .....	362.91
90-50230	Kit, 801 Flowmeter, w/ 1" Hose Barbs .....	713.55
435EC-2-D*	430EC-2 Manifold* .....	1,515.88
	<b>Total</b> .....	<b>\$8,280.28</b>
<b>845 RATE CONTROL SYSTEM WITH BALL VALVES, MATRIX 908 AND AUTO SECTION CONTROL</b>		
<b>EXAMPLE:</b>		
90-50268	Kit, 845, Mounting Bracket, PWR Cable, User Guide .....	\$ 1,721.11
45-10106-MD	Harness, 5 Sect. Ball Valves, MINI-DIN .....	1,322.24
98600-C-435EC-2*	430 2WY MNFD w/FM, STR, REG BY, PR* .....	3,266.93
90-10006 -ENUS-NH**	Kit, M908 NAV-L1-GLO-ENUS, No Hrns .....	3,093.40
45-10236	Hrns, 908-NAV-TJD-PWP-RS-SS-PO-SP .....	406.49
90-02990	Kit, BoomPilot SDM/Harness, TeeJet 845, M908 .....	2,183.57
45-20042	Cable, 844 to Dj 39512 .....	120.82
	<b>Total</b> .....	<b>\$ 12,114.56</b>
<b>RADION 8140 RATE CONTROL SYSTEM WITH BALL VALVES, MATRIX 908 AND AUTO SECTION CONTROL</b>		
<b>EXAMPLE:</b>		
90-50259	Kit, Radion 8140-5, RAM Mount, PWR Cable, User Guide .....	\$ 3,623.47
45-10106-MD	Harness, 5 Sect. Ball Valves, MINI-DIN .....	1,322.24
98600-C-435EC-2*	430 2WY MNFD w/FM, STR, REG BY, PR* .....	3,266.93
90-10006 -ENUS-NH**	Kit, M908 NAV-L1-GLO-ENUS, No Hrns .....	3,093.40
45-10236	Hrns, 908-NAV-TJD-PWP-RS-SS-PO-SP .....	406.49
45-04068	Cable, Radion CAN to M908, 6 POS DTM W/TERM., 7' .....	226.70
98-50143	Unlock Code, ABSC for Radion Console .....	1,151.58
	<b>Total</b> .....	<b>\$ 13,090.81</b>
<b>RADION 8140 9 SECTION RATE CONTROL SYSTEM WITH BALL VALVES, MATRIX 908 AND AUTO SECTION CONTROL</b>		
<b>EXAMPLE:</b>		
90-50265	Kit, Radion 8140-9, RAM Mount, No Power Cable, User Guide .....	\$ 3,810.52
45-10152-MP	Harness, 9 Sect. Ball Valves, w/o PWR, 3 POS MP150 Tower, 10' .....	1,544.01
45-10050	Harness Spraylink, For 10 Sect. Consoles .....	669.57
35-02099	Valve, 1", 3 RPM .....	362.91
90-50230	Kit, 801 Flowmeter, w/ 1" Hose Barbs .....	713.55
439EC-2-D*	430EC-2 Manifold* .....	2,728.51
90-10006 -ENUS-NH**	Kit, M908 NAV-L1-GLO-ENUS, No Hrns .....	3,093.40
45-10236	Harness, 908-NAV-TJD-PWP-RS-SS-PO-SP .....	406.49
45-04068	Cable, Radion CAN to M908, 6 POS DTM W/TERM., 7' .....	226.70
98-50143	Unlock Code, ABSC for Radion Console .....	1,151.58
	<b>Total</b> .....	<b>\$ 15,070.15</b>

\*Shut off valve manifolds are ordered from TeeJet Wheaton office. Additional fittings may be necessary.

\*\* Kits shown on this page are subject to guidance discount

# **ISOBUS APPLICATION CONTROLS**

**ISOBUS SOLUTIONS FOR SPRAYERS  
IC45 - MATRIX 908**

# ISOBUS UNIVERSAL TERMINAL AND SWITCH BOXES

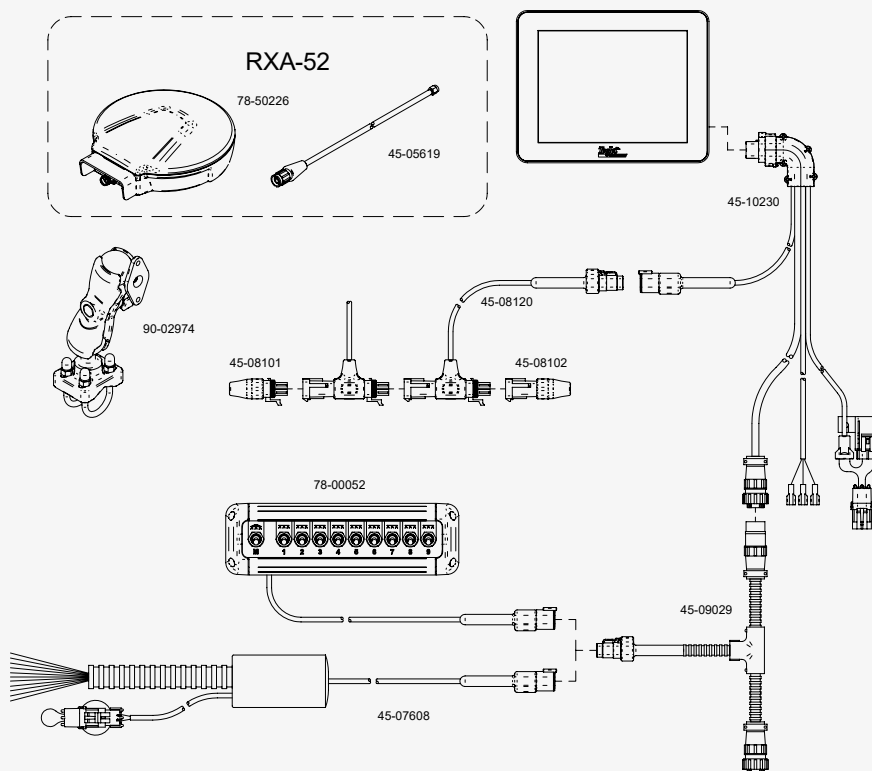

**Universal Terminal:** Provides guidance, Auto-steering, Automatic section control, Implement control and a large amount of options. Contains a GNSS receiver which uses GPS, GLONASS and EGNOS, and as an option PPP signals which has a higher accuracy.

**ISOBUS Switch box / ISM module:** A selection of user interfaces are available to cover the needs for most customer operating sprayers. It ranges from simple operation of Master and sections to full control of all hydraulic functions and various electrical driven functions. ISM modules can be offered to those who want to integrate the switches in their machine.

**RXA52 Antenna:** Matrix 908 can receive GPS, GLONASS, BeiDou\*, Galileo\* and QZSS\*, along with TerraStar correction signals\*. Compatible with TerraStar-C PRO corrections for repeatable 3 cm/1.2 in (95%) accuracy, which means < 2 cm/0.8 in pass-to-pass accuracy. Compatible with TerraStar-L correction service for 15 cm/ 6 in (95%) pass-to-pass performance.

**RAM mount:** Versatile mounting bracket enabling install of In cab units in most places.

*\* Note: These signals require the purchase of a "one-time" GNSS upgrade and the TerraStar correction signal also requires a monthly or yearly subscription.*

## ISM MODULE:

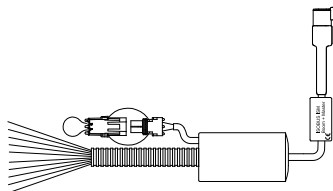

A switch interface enabling a versatile interface to those who require integration of switches into the machine. Are available in different versions for sections and/or hydraulic functions.

## SLIM SWITCH BOX:

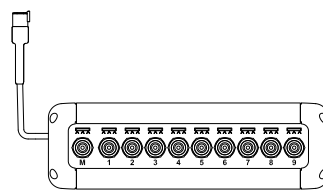

A switch interface enabling an easy access to control of master and up to 9 section valves.

MATRIX 908 KITS SHOWN ON THIS PAGE ARE SUBJECT TO GUIDANCE DISCOUNT

### 90-10011-XX KIT PARTS DIAGRAM

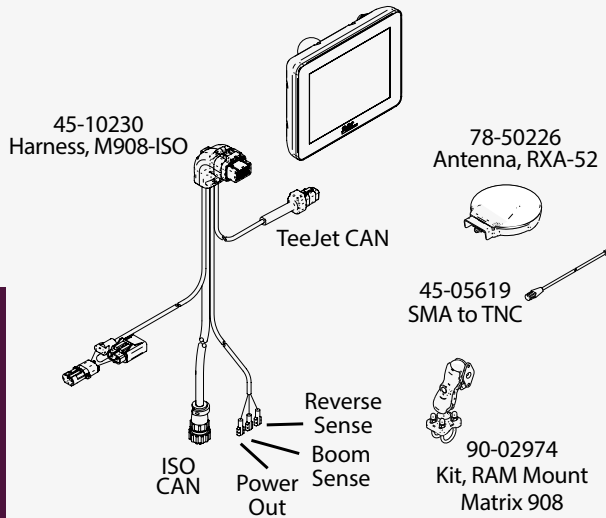

PART NO.	DESCRIPTION	U.S. DOLLARS
<b>ISO KIT WITH INTERNAL RECEIVER</b>		
90-10011-ENUS	KIT, M908 ISO-L1-GLO-ENUS.....	\$ 4,432.64
90-10012-ENUS	KIT, M908 ISO-L2+TSL-GLO-ENUS.....	4,631.64
90-10013-ENUS	KIT, M908 ISO-L2+TSC-GLO-ENUS.....	6,000.37

### MORE INFORMATION ABOUT KITS

The kits 90-10011-xx, 90-10012-xx & 90-10013-xx contain the part numbers below.

75-100xx-EN	Matrix 908 ISOBUS display.....
45-10230	Harness, Matrix 908, 6'/2.35 m TeeJet CAN/ ISOBUS CAN/ RS/ BS/ Power in.....
90-02974	RAM Mount Kit for Matrix 908.....
90-07009	Screen cleaning cloth Matrix 908.....
98-01578-xx	User manual, Matrix 908.....

## SYSTEM DIAGRAM

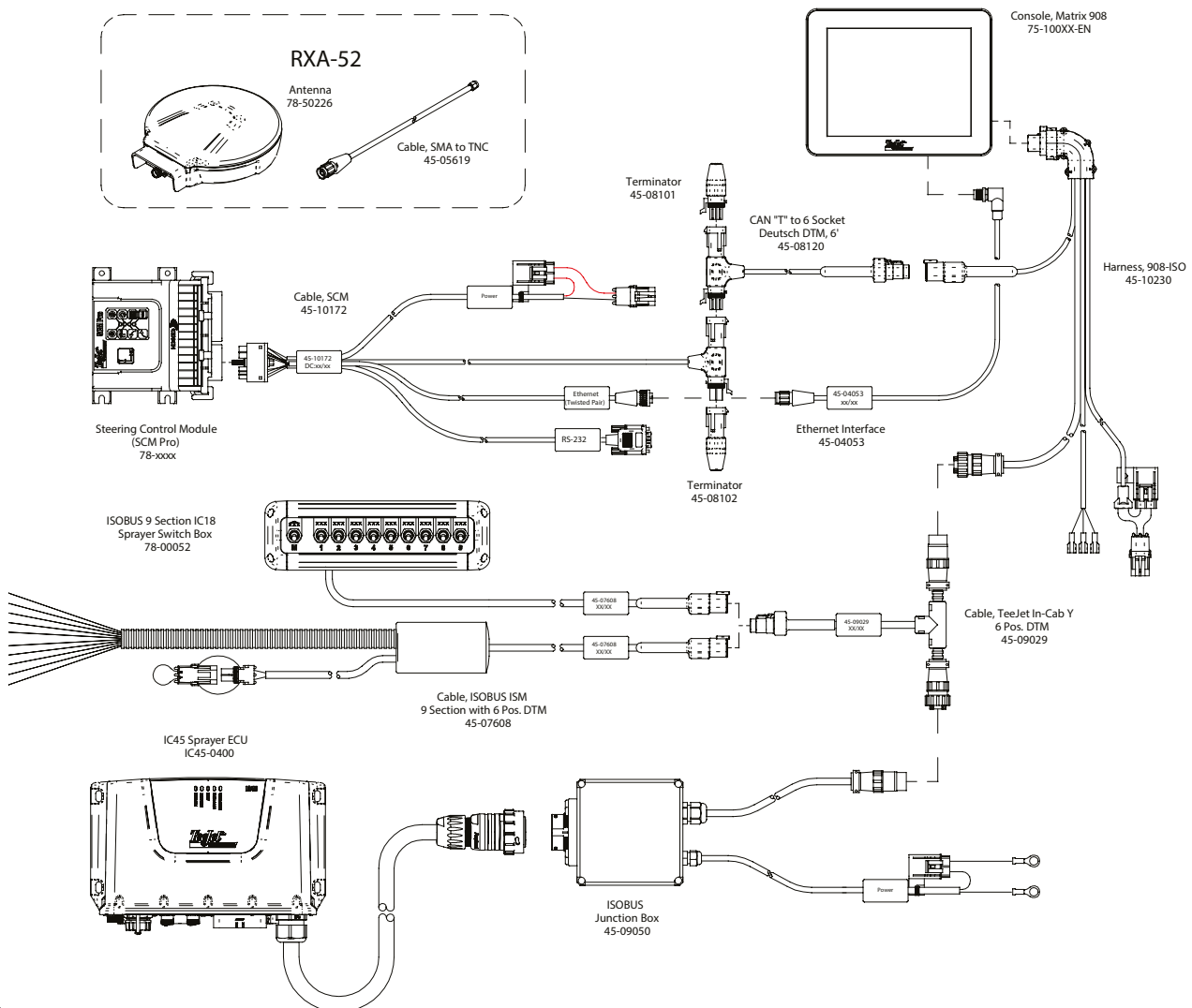

ISOBUS APPLICATION CONTROLS

# ISOBUS IC45 SPRAYER

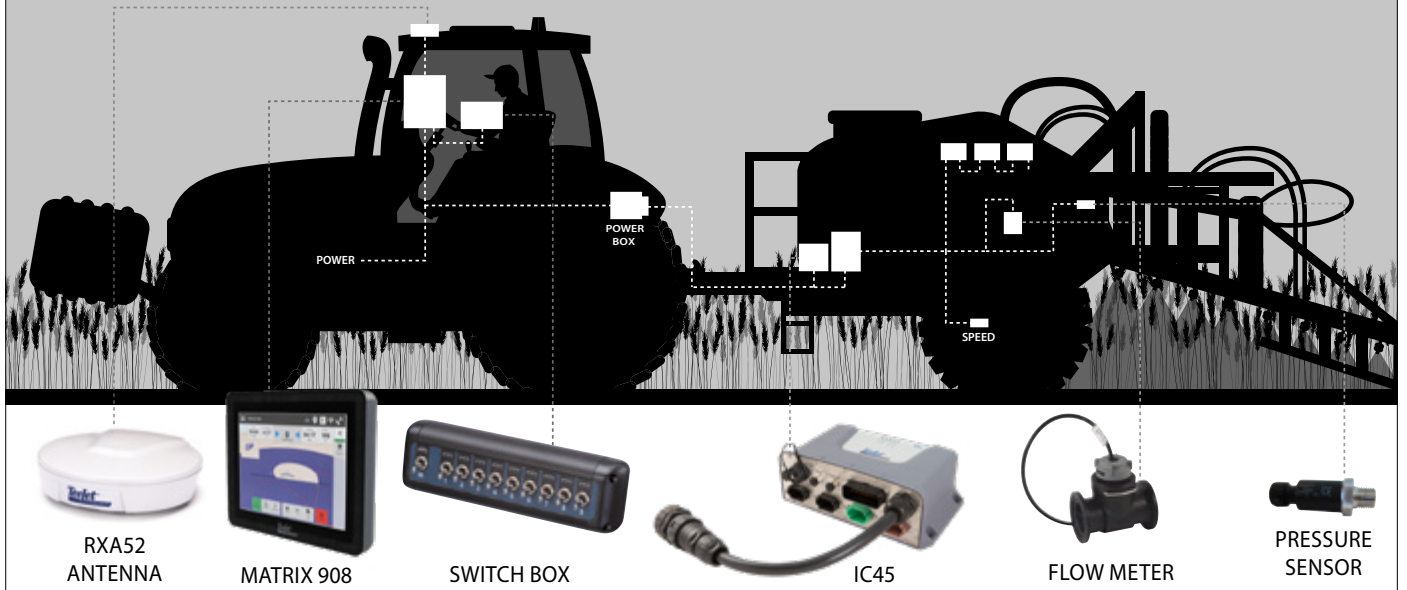

ISOBUS APPLICATION CONTROLS

# ISOBUS IC45 SPRAYER

SYSTEM DIAGRAM

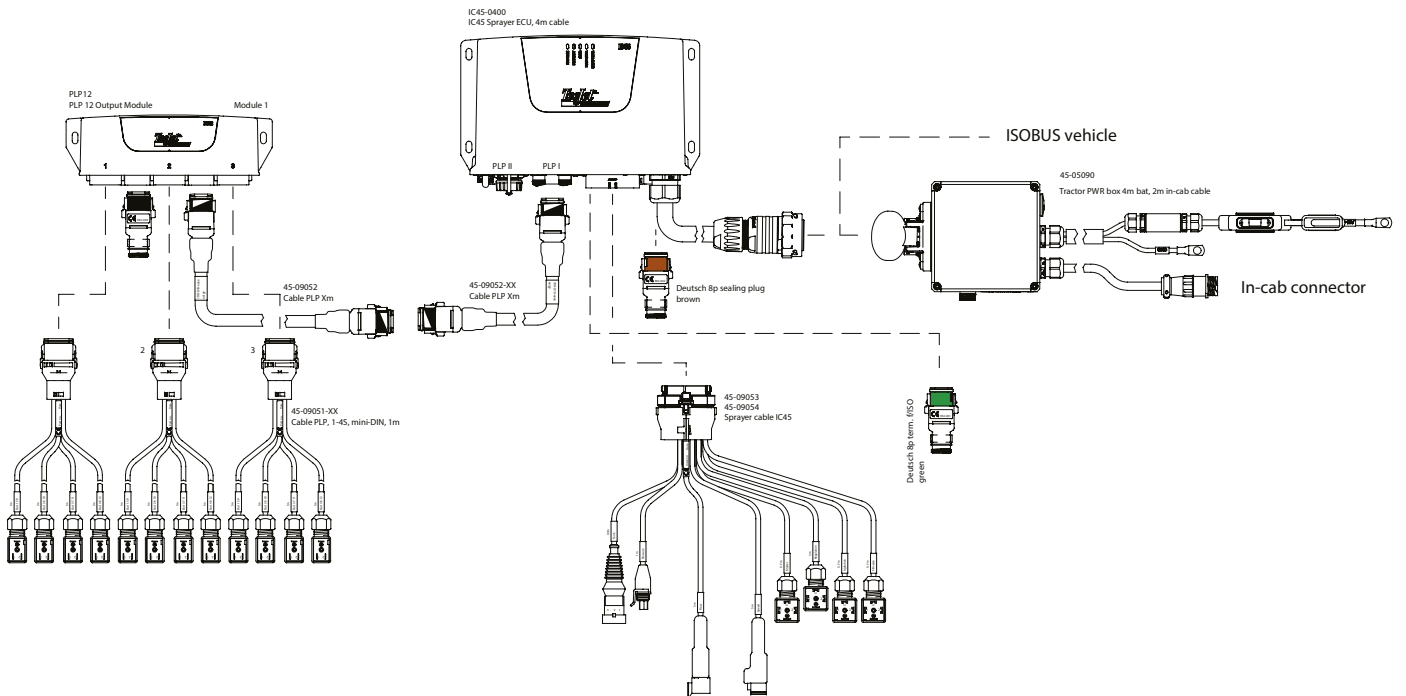

# ISOBUS IC45 SPRAYER

## RATE CONTROL PLUS OPTIONAL TEEJET CAN DEVICES

ISOBUS APPLICATION CONTROLS

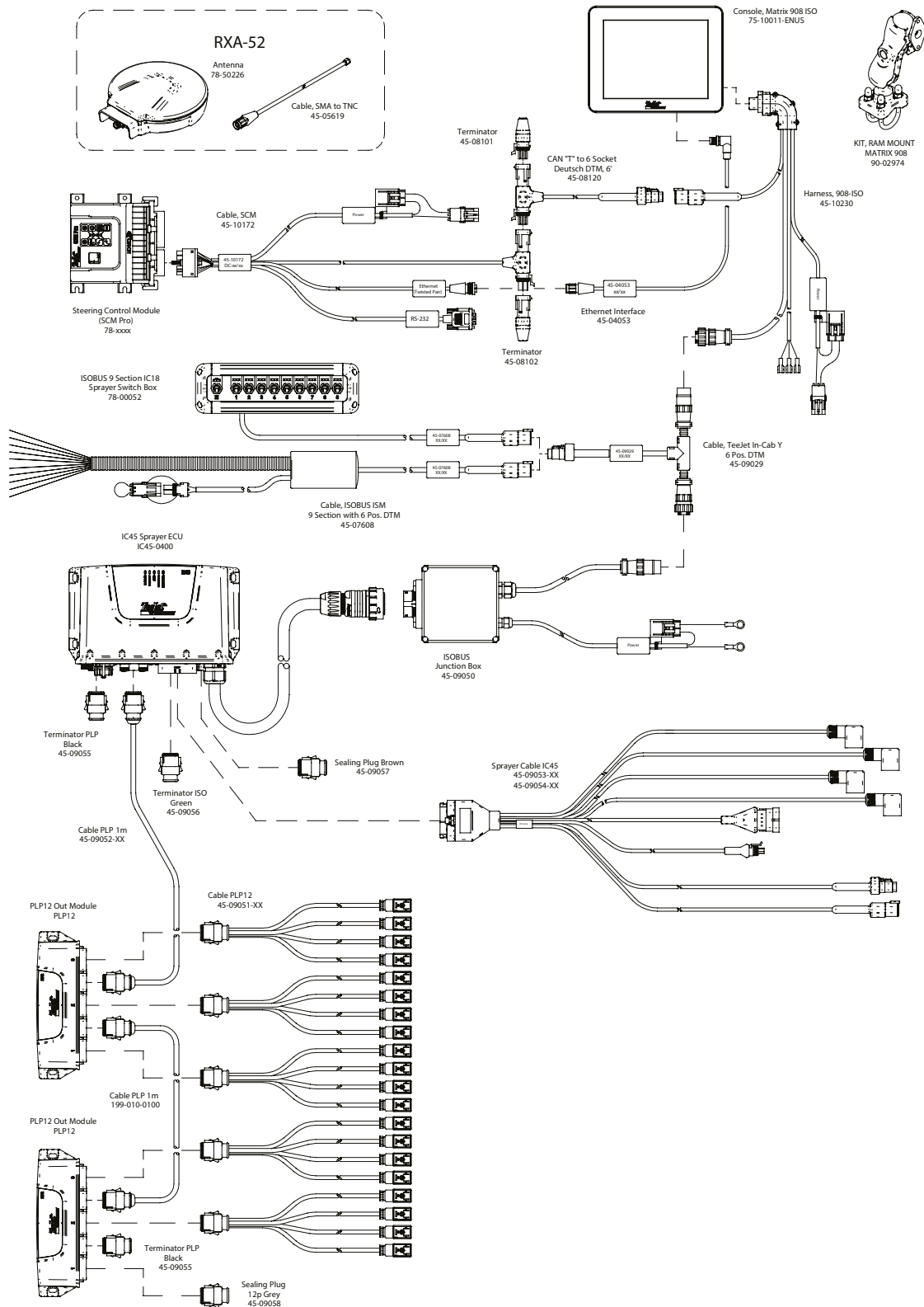

**Note:** Matrix 908 System Diagram connectivity to some devices may be released with future software releases. Always refer to software release notes for software/system connectivity at [www.teejet.com/support/software.aspx](http://www.teejet.com/support/software.aspx).



# ISOBUS IC45 SPRAYER

IC45 SPRAY JOB COMPUTER :  
IC45-XXXX



IC45 SPRAYER CABLE :  
45-09053-XX  
45-09054-XX



PLP12 OUTPUT MODULE :  
PLP12



PLP CAN CABLE :  
45-09052-XX



PLP12 CABLE, 1-4 SECTION MINI-DIN :  
45-09051-XX



PART NO.	DESCRIPTION	U.S. DOLLARS
<b>IC45 ECU SPRAY JOB COMPUTER WITH INTEGRATED CABLE</b>		
IC45-0400	IC45 Sprayer ECU, 13'7/4 m cable . . . . .	\$3,263.06
IC45-0050	IC45 Sprayer ECU, 1.6'/0.5 meters cable . . . . .	3,124.14
45-09055	Terminator, DT 8 Position, PLP, Black . . . . .	58.66
45-09056	Terminator, DT 8 Position, ISO, Green . . . . .	58.66
45-09057	Sealing Plug, DT 8 Position, Brown, Key D . . . . .	26.48

### IC45 SPRAYER CABLE

45-09053-05	Cable, IC45 Sprayer, 5'/1.5m, DT/M'N'L/MP150, SPEED 1.6'/0.5m	\$ 300.47
45-09053-10	Cable, IC45 Sprayer, 10'/3m, DT/M'N'L/MP150, SPEED 1.6'/0.5m	317.54
45-09053-20	Cable, IC45 Sprayer, 20'/6m, DT/M'N'L/MP150, SPEED 1.6'/0.5m	351.66
45-09054-05	Cable, IC45 Sprayer, 5'/1.5m, WP/MP150/AMP, SPEED 1.6'/0.5m .	300.47
45-09054-10	Cable, IC45 Sprayer, 10'/3m, WP/MP150/AMP, SPEED 1.6'/0.5m .	317.54
45-09054-20	Cable, IC45 Sprayer, 20'/6m, WP/MP150/AMP, SPEED 1.6'/0.5m .	351.66

### JUNCTION BOX AND EXTENSION CABLES

45-09050	Harness, Junction Box, Battery Ring . . . . .	\$ 1,457.64
45-09023	Harness, 20' EXT. ISOBUS Hitch to IBBC . . . . .	1,220.44
45-09024	Harness, 30' EXT. ISOBUS Hitch to IBBC . . . . .	1,420.38
45-09025	Harness, 40' EXT. ISOBUS Hitch to IBBC . . . . .	1,535.70

### PLP12 OUTPUT MODULE

PLP12	PLP Module 12 Outputs . . . . .	\$ 577.04
45-09055	Terminator, DT 8 Position, PLP, Black . . . . .	58.66
45-09058	Sealing Plug, DT 12 Position, Grey, Key A . . . . .	26.48

### PLP CAN CABLE

45-09052-05	Cable, IC45 PLP CAN CABLE, 5'/1.5m . . . . .	\$ 174.55
45-09052-10	Cable, IC45 PLP CAN CABLE, 10'/3m . . . . .	191.06
45-09052-20	Cable, IC45 PLP CAN CABLE, 20'/6m . . . . .	224.09

### PLP OUTPUT CABLE

#### ELECTRICAL & VALVES FUNCTIONS

45-09051-MD	Cable PLP12, 4 Output, Mini-DIN, 3.28'/ 1m . . . . .	\$ 182.44
45-09051-MP	Cable PLP12, 4 Output, Metri-Pack, 3.28'/ 1m. . . . .	182.44
45-09051-UX	Cable PLP12, 4 Output, Weather Pack, 3.28'/ 1m. . . . .	182.44

### ADAPTERS & MISC CABLE

45-09029	Cable, TeeJet, In-Cab, "Y" . . . . .	\$ 288.28
45-09030	Cable, TeeJet, In-Cab, "Y", 9 Pos Amp . . . . .	288.28
45-04089	Cable, Adapter, 9 Pos Amp to 6 Pos DTM . . . . .	153.53

# ISOBUS IC45 SPRAYER

ISOBUS APPLICATION CONTROLS



MATRIX® 908

IC45 SPRAY JOB COMPUTER



IC45 SPRAYER CABLE



PLP



FLOW METER

PART NO.	DESCRIPTION	U.S. DOLLARS	
<b>ISOBUS IC45 HOW TO ORDER:</b>			
<b>STEP 1: CHOOSE FIELD COMPUTER KIT WITH UNIVERSAL TERMINAL FUNCTION</b>			
90-10011 -ENUS	KIT, M908 ISO-L1-GLO-ENUS.....	\$ 4,432.64	
90-10012 -ENUS	KIT, M908 ISO-L2+TSL-GLO-ENUS.....	4,631.64	
90-10013 -ENUS	KIT, M908 ISO-L2+TSC-GLO-ENUS.....	6,000.37	
<i>Note: Matrix 908 kits are subject to guidance discount.</i>			
<b>STEP 2: CHOOSE IBBC JUNCTION BOX</b>			
45-09050	Harness, Junction Box, Battery Ring.....	\$ 1,457.64	
<b>STEP 3: CHOOSE ISOBUS RATE CONTROL ECU</b>			
IC45-0050	Module, IC45 Sprayer 1.6' / 0.5m ISOBUS Cable.....	\$ 3,124.14	1
IC45-0400	Module, IC45 Sprayer 13' / 4m ISOBUS Cable.....	3,263.06	1
<b>STEP 4: CHOOSE SWITCHBOX OR ISM (AS NEEDED)</b>			
78-00052	Switchbox, 9 Boom ISO.....	\$ 957.73	2
45-07608	Cable, ISOBUS ISM, 9 Boom + Master w/ 6 POS DTM.....	405.00	3
45-07609	Cable, ISOBUS ISM, 15 Boom + Master w/ 6 POS DTM.....	480.37	3
<b>STEP 5: CHOOSE IC45 REG VALVE/ SENSOR HARNESS</b>			
45-09053-05	Cable, IC45 Sprayer, 5'/1.5 m DT/M'n'L/ MP150, SPD 1.6'/.5m.....	\$ 300.47	
45-09053-10	Cable, IC45 Sprayer, 10'/3 m DT/M'n'L/ MP150, SPD 1.6'/.5m.....	317.54	
45-09053-20	Cable, IC45 Sprayer, 20'/6 m DT/M'n'L/ MP150, SPD 1.6'/.5m.....	351.66	
45-09054-05	Cable, IC45 Sprayer, 5'/1.5 m WP/ MP150/AMP SPEED 1.6'/0.5m.....	300.47	
45-09054-10	Cable, IC45 Sprayer, 10'/3 m DT/M'n'L/ MP150, SPEED 1.6'/0.5m.....	317.54	
45-09054-20	Cable, IC45 Sprayer, 20'/6 m DT/M'n'L/ MP150, SPEED 1.6'/0.5m.....	351.66	
<b>STEP 6: CHOOSE NUMBER OF PLP MODULES &amp; CABLES (BASED ON NUMBER OF BOOM SECTIONS)</b>			
PLP12	PLP 12 Module (Up to 12 Boom Sections).....	\$ 577.04	
45-09051-MD	Cable, PLP12, 4 OUTPUT, MINI-DIN, 3.28'/1 m.....	182.44	
45-09051-MP	Cable, PLP12, 4 OUTPUT, METRI-PACK, 3.28'/1 m.....	182.44	
45-09051-UX	Cable, PLP12, 4 OUTPUT, WEATHER PACK, 3.28'/1 m.....	182.44	
45-09055	Terminator, DT 8 Position, PLP, Black Key B.....	58.66	
45-09056	Terminator, DT 8 Position, ISO, Grn Key C.....	58.66	4
<b>STEP 7: CHOOSE PLP CAN CABLES (AS NEEDED)</b>			
45-09052-05	Cable, IC45 PLP CAN CABLE, 5'/ 1.5 m.....	\$ 174.55	
45-09052-10	Cable, IC45 PLP CAN CABLE, 10'/ 3 m.....	191.06	
45-09052-20	Cable, IC45 PLP CAN CABLE, 20'/ 6 m.....	224.09	5
<b>STEP 8: CHOOSE VALVES (AS NEEDED)</b>			
35-02083	VALVE, AUTORANGE, 1" PP, 3 SEC B SERIES.....	\$ 508.10	
35-02084	VALVE, AUTORANGE, 1-1/2" PP, 3 SEC B SERIES.....	742.04	
35-02085	VALVE, CONTROL, 1" PP, 3 SEC B SERIES.....	432.12	
35-02086	VALVE, CONTROL, 1-1/2" PP, 3 SEC B SERIES.....	742.04	
35-02099	VALVE, 1", 3 RPM.....	362.91	
<b>STEP 9: CHOOSE SENSORS (AS NEEDED)</b>			
90-02176	Kit, 801 F.M. & Interface w/ 1" Hose Barbs (For 45-09054-XX Harness).....	\$ 835.19	
90-50230	Kit, 801 Flowmeter w/ 1" Hose Barbs (For 45-09053-XX Harness).....	713.55	
57-10122	Flowmeter, 802, Assembly (For 45-09053-XX Harness).....	759.55	
16-05015	Sensor Pressure, 10 Bar (For 45-09053-XX or 45-09054-XX Harness).....	345.02	
90-02371	Kit, GPS Speed Sensor Mid-Tech Controls.....	742.23	
<b>STEP 10: CHOOSE EXTENSION CABLES OR COMPONENTS (OPTIONAL)</b>			
45-09023	Harness, 20' EXT. ISOBUS Hitch to IBBC.....	\$ 1,220.44	
45-09024	Harness, 30' EXT. ISOBUS Hitch to IBBC.....	1,420.38	
45-09025	Harness, 40' EXT. ISOBUS Hitch to IBBC.....	1,535.70	
45-20017	Cable, 3 Position DT 15' Flow Meter Or Speed Extension.....	154.00	
404-0045	Cable, 3 Position Weather Pack 18' Flow Meter Extension.....	149.92	
32-04061	Switch, Remote Foot With Weatherpack.....	219.84	6

**Notes:**

- 1 IC45-XXXX includes 45-09055 (qty 2), 45-09056 and 45-09057.
- 2 When 78-00052 is ordered, also need to add a 65-05050 (RAM MOUNT KIT) and a 45-09029 (In-Cab Y cable).
- 3 When a 45-07608 or 45-07609 is ordered, also need to add a 45-09029 (In-Cab Y cable).
- 4 There will need to be a 45-09058 for any open PLP valve connections.
- 5 Shutoff valves also need to be added/ordered for sprayers. Additional fittings may be necessary as well.
- 6 Remote foot switch may require an XML configuration change on the IC45.

# ISOBUS IC45 SPRAYER

PART NO.	QTY	DESCRIPTION	U.S. DOLLARS
<b>ISOBUS RATE CONTROL ORDERING EXAMPLES</b>			
<b>EXAMPLE: TO ORDER A ISOBUS SPRAYER SYSTEM FOR AN ISOBUS READY TRACTOR WITH EXISTING UNIVERSAL TERMINAL (NO VALVES OR SENSORS)</b>			
IC45-0400	1	Module, IC45 Sprayer 13'/ 4 m ISOBUS Cable .....	\$ 3,263.06
78-00052	1	Switchbox, 9 Boom ISO .....	957.73
65-05050	1	Bracket, RAM-101u .....	134.14
45-09029	1	Cable, TeeJet In-Cab "Y" .....	288.28
45-04037	1	Cable, ISOBUS 11783, In-Cab, 9P AMP .....	204.18
45-09053-20	1	Cable, IC45 Sprayer, 20'/ 6 m DT/ M'n'L/ MP150, SPD 1.6'/ .5 m .....	351.66
PLP12	1	PLP 12 Module (Up to 12 Boom Sections) .....	577.04
45-09051-MD	3	Cable, PLP12, 4 OUTPUT, MINI-DIN, 3.28'/1m .....	547.32
45-09052-20	1	Cable, IC45 PLP CAN CABLE, 20'/6m .....	224.09
		<b>Total</b> .....	<b>\$ 6,547.50</b>
<b>EXAMPLE: TO ORDER A ISOBUS SPRAYER SYSTEM WITH MATRIX 908 FOR A NON-ISOBUS TRACTOR (NO VALVES OR SENSORS)</b>			
90-10011 -ENUS	1	Kit, M908 ISO-L1-GLO-ENUS .....	\$ 4,432.64
45-09050	1	Harness, Junction Box, Battery Ring .....	1,457.64
IC45-0400	1	Module, IC45 Sprayer 13'/4m ISOBUS Cable .....	3,263.06
45-09054-20	1	Cable, IC45 Sprayer, 20'/6m, WP/MP150/AMP, SPEED 1.6'/0.5m .....	351.66
78-00052	1	Switchbox, 9 Boom ISO .....	957.73
65-05050	1	Bracket, RAM-101u .....	134.14
45-09029	1	Cable, TeeJet In-Cab "Y" .....	288.28
PLP12	1	PLP 12 Module (Up to 12 Boom Sections) .....	577.04
45-09051-WP	3	Cable, PLP12, 4 OUTPUT, WEATHER PACK, 3.28'/1m .....	547.32
45-09052-20	1	Cable, IC45 PLP CAN CABLE, 20'/6m .....	224.09
		<b>Total</b> .....	<b>\$ 12,233.60</b>
<b>EXAMPLE: TO ORDER A ISOBUS SPRAYER SYSTEM WITH MATRIX 908 FOR A NON-ISOBUS TRACTOR WITH HIGH ACCURACY PPP SOLUTION (WITH VALVES &amp; SENSORS)</b>			
90-10013 -ENUS	1	Kit, M908 ISO-L2+TSC-GLO-ENUS .....	\$ 6,000.37
99-01088*	1	Subscription, TERRASTAR-C PRO, 1 Year* .....	1,050.00
45-09050	1	Harness, Junction Box, Battery Ring .....	1,457.64
IC45-0400	1	Module, IC45 Sprayer 13'/ 4 m ISOBUS Cable .....	3,263.06
45-09053-20	1	Cable, IC45 Sprayer, 20'/ 6 m DT/ M'n'L/ MP150, SPD 1.6'/ .5 m .....	351.66
78-00052	1	Switchbox, 9 Boom ISO .....	957.73
65-05050	1	Bracket, RAM-101u .....	134.14
45-09029	1	Cable, TeeJet In-Cab "Y" .....	288.28
PLP12	1	PLP 12 Module (Up to 12 Boom Sections) .....	577.04
45-09051-MD	3	Cable, PLP12, 4 OUTPUT, MINI-DIN, 3.28'/1m .....	547.32
45-09052-20	1	Cable, IC45 PLP CAN CABLE, 20'/6m .....	224.09
35-02099	1	VALVE, 1", 3 RPM .....	362.91
90-50230	1	Kit, 801 Flowmeter w/ 1" Hose Barbs .....	713.55
16-05015	1	Sensor Pressure, 10 Bar .....	345.02
		<b>Total</b> .....	<b>\$ 16,272.81</b>

\* Subscription is a net price so no additional discount is available.

\*\* Shut off valve manifolds are ordered from TeeJet Wheaton office. Additional fittings may be necessary.

# ISOBUS IC38 SPREADER

ISOBUS APPLICATION CONTROLS

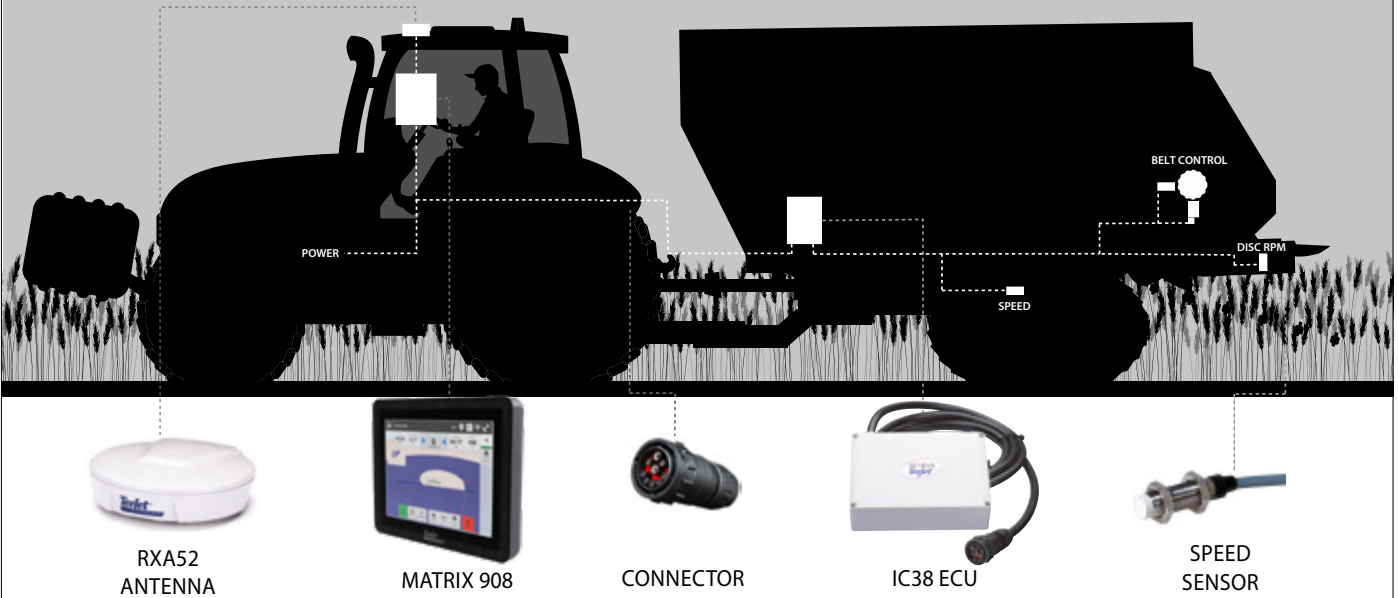

## IC38 SPREADER JOB COMPUTER

### SYSTEM DIAGRAM

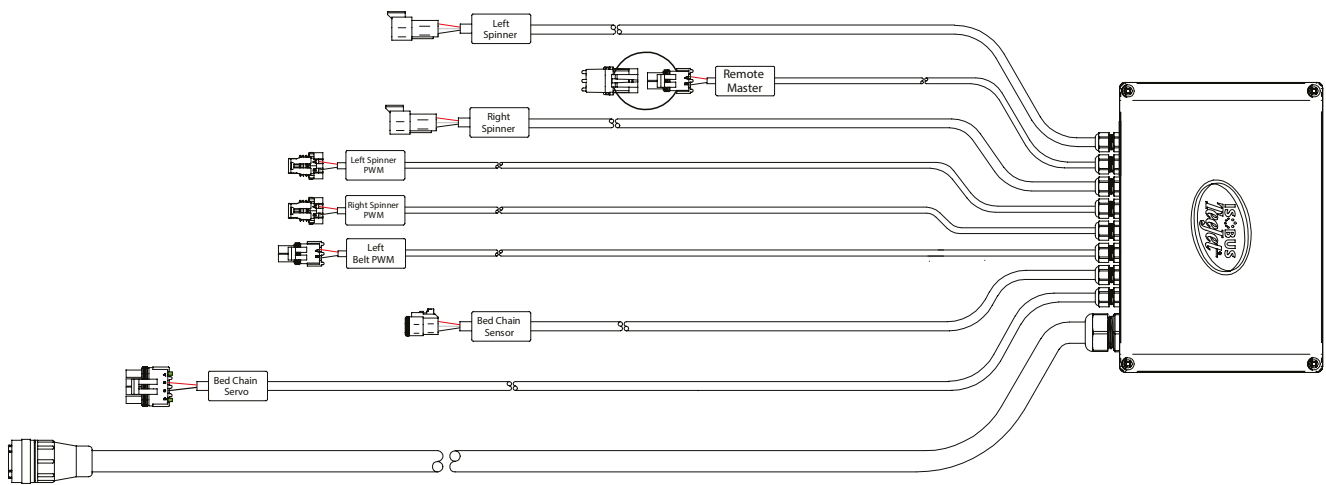

**IC38 Spreader job computer:** A versatile ISOBUS spreader control. IC38 Spreader offers control of most common functions on a spreader. IC38 Spreader has variable rate control as standard. The IC38 Spreader is adapted to the individual machine to optimize all electrical and hydraulic functions to give outstanding on-ground performance.

**IC38 Spreader tractor cable:** The interface cable between the ECU and the tractor / terminal.

**IC38 Spreader cable:** Contains the connections to the actuators and sensors

# ISOBUS SPREADER RATE CONTROL

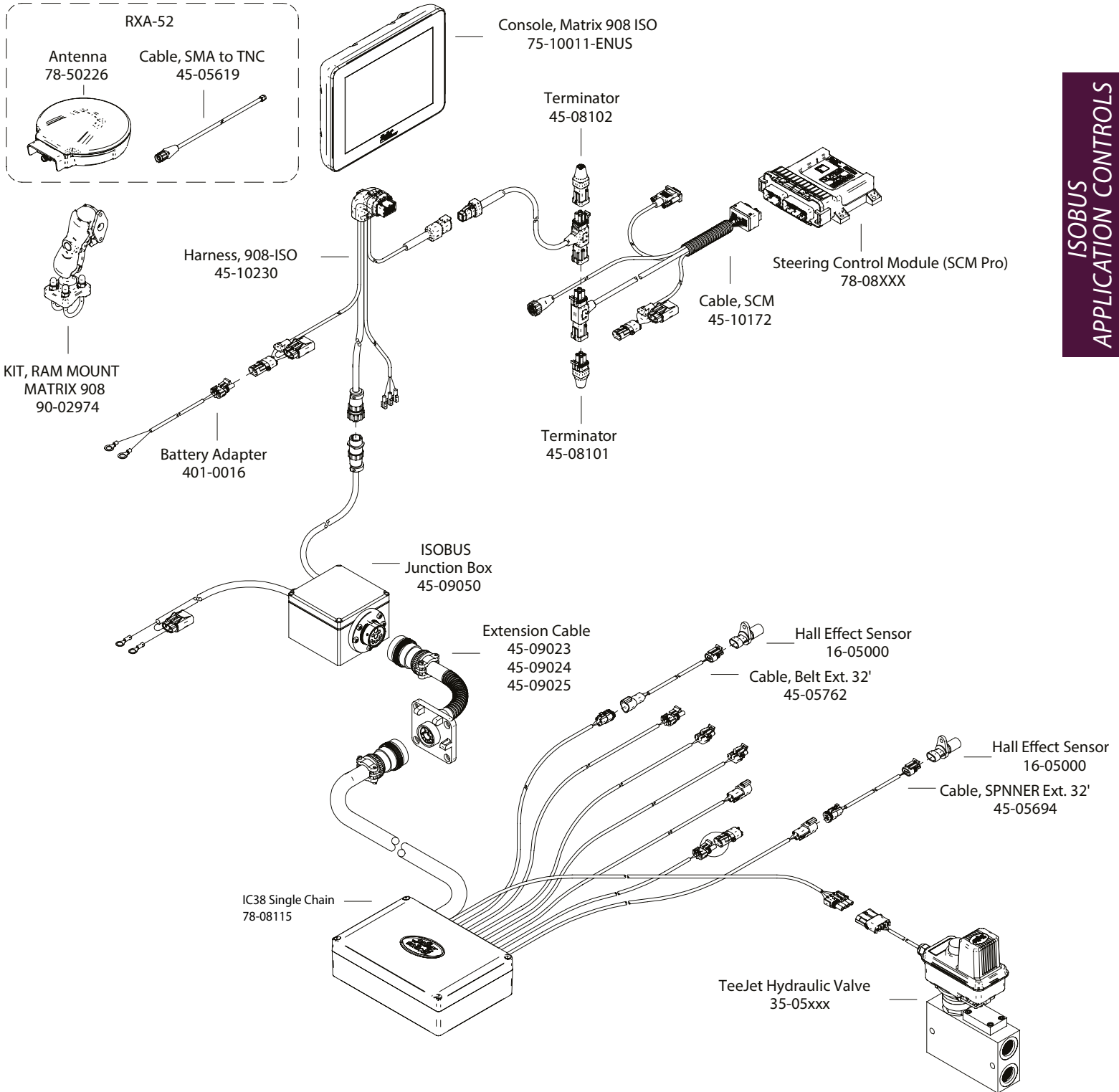

# ISOBUS IC38 SPREADER

ISOBUS APPLICATION CONTROLS



MATRIX® 908



IC38 SPRAY JOB COMPUTER



GEAR SENSOR



EXTENSION CABLE

PART NO.	DESCRIPTION	U.S. DOLLARS
----------	-------------	--------------

**ISOBUS IC38 HOW TO ORDER:**

**STEP 1: CHOOSE FIELD COMPUTER KIT WITH UNIVERSAL TERMINAL FUNCTION**

90-10011 -ENUS	KIT, M908 ISO-L1-GLO-ENUS .....	\$ 4,432.64
90-10012 -ENUS	KIT, M908 ISO-L2+TSL-GLO-ENUS .....	4,631.64
90-10013 -ENUS	KIT, M908 ISO-L2+TSC-GLO-ENUS .....	6,000.37

**STEP 2: CHOOSE IBBC JUNCTION BOX**

45-09050	Harness, Junction Box, Battery Ring .....	\$ 1,457.64
----------	---	-------------

**STEP 3: CHOOSE ISOBUS RATE CONTROL ECU**

78-08115	Module, IC38, Single Chain, Single Section, 15' IBBC .....	\$ 5,068.12
78-08117	Module, IC38, One Bin, Two chains, 2 Sections, 15' IBBC .....	5,592.30

**STEP 4: CHOOSE VALVES (AS NEEDED)**

35-02128	Valve, EXR-4, 30 GPM, 3 Sec, 3/#12 Port .....	\$ 1,514.76
35-02127	Valve, EXR-4, 30 GPM, 3 Sec, 3/#12 Port Press Relief .....	2,010.03
35-02125	Valve, EXR-4, 20 GPM, 3 Sec, 3/#12 Port .....	1,514.76
35-02123	Valve, EXR-4, 15 GPM, 3 Sec, 3/#12 Port .....	1,514.76
35-05013	Cartridge Assy, EXR-4, 3 Sec, 30 GPM, .....	1,127.59

**STEP 5: CHOOSE BELT SENSORS & CABLES (AS NEEDED)**

16-05024	Kit, Rawson Gear Sensor, ISO Belt .....	\$ 354.79	
120-0009	Sensor, Application Rate 360 Slot, 10' Cable .....	660.74	1
45-04087	Cable, 1', Slot Adapter, 3Pos DT - 3Pos WP Shroud .....	102.01	2
45-04093	Cable, 20', Slot Adapter, 3Pos DT - 3Pos WP Shroud .....	134.79	3

**STEP 6: CHOOSE SPINNER SENSORS & CABLES (AS NEEDED)**

16-05025	Kit, Rawson Gear Sensor, ISO Spinner	354.79	
16-40004	Sensor, Proximity	147.24	4
45-05817	Cable, 20' Spinner Adapter, 3 Pos DT plug- 3 Pos DT plug	178.98	
120-0041	Sensor, Inductive, 8 mm threaded, W/6 Ft Cable, 3 Pos WP	305.29	5
45-05861	Cable, 32' Spinner Adapter, 3 Pos DT plug- 3 PosWP Tower	125.93	

**STEP 7: CHOOSE EXTENSION CABLES OR COMPONENTS (OPTIONAL)**

45-09023	Harness, 20' EXT. ISOBUS Hitch to IBBC .....	\$ 1,220.44
45-09024	Harness, 30' EXT. ISOBUS Hitch to IBBC .....	1,420.38
45-09025	Harness, 40' EXT. ISOBUS Hitch to IBBC .....	1,535.70
45-20017	Cable, 3 Position DT 15' Flow Meter Or Speed Extension .....	154.00
404-0045	Cable, 3 Position Weather Pack 18' Flow Meter Extension .....	149.92
32-04061	Switch, Remote Foot With Weatherpack .....	219.84

**Notes:**

- 1 An adapter cable must be ordered when buying a 120-0009 slot sensor. E.G. 45-04087 or 45-04093.
- 2 The 1' cable could be used for situations that the IC38 is within 10 foot of the slot sensor mounting location.
- 3 The 20' cable is recommend for all other mounting locations to allow sufficient length.
- 4 The 45-05817 adapter cable is needed to connect the 16-40004 to the IC38 as a spinner sensor.
- 5 The 45-05861 adapter cable is needed to connect the 120-0041 to the IC38 as a spinner sensor.



# ISOBUS IC38 SPREADER

PART NO. QTY DESCRIPTION U.S. DOLLARS

## ISOBUS RATE CONTROL ORDERING EXAMPLES

**EXAMPLE: TO ORDER AN ISOBUS SINGLE CHAIN/SINGLE SENSOR SPREADER SYSTEM FOR AN ISOBUS READY TRACTOR WITH EXISTING UNIVERSAL TERMINAL (WITH SENSORS, NO VALVES)**

78-08115	1	Module, IC38, Single Chain, Single Section, 15' IBBC .....	\$ 5,068.12
16-05024	1	Kit, Rawson Gear Sensor, Belt .....	354.79
16-05025	1	Kit, Rawson Gear Sensor, Spinner .....	354.79
		<b>Total</b> .....	<b>\$ 5,777.70</b>

**EXAMPLE: TO ORDER AN ISOBUS TWO CHAIN/TWO SECTION SPREADER SYSTEM FOR AN ISOBUS READY TRACTOR WITH EXISTING UNIVERSAL TERMINAL (WITH SENSORS, NO VALVES)**

78-08117	1	Module, IC38, One Bin, Two chains, 2 Sections, 15' IBBC .....	\$ 5592.30
16-05024	2	Kit, Rawson Gear Sensor, Belt .....	709.58
16-05025	1	Kit, Rawson Gear Sensor, Spinner .....	354.79
		<b>Total</b> .....	<b>\$ 6,656.67</b>

**EXAMPLE: TO ORDER AN ISOBUS SINGLE CHAIN/SINGLE SECTION SYSTEM WITH MATRIX® 908 FOR A NON-ISOBUS TRACTOR (WITH VALVES OR SENSORS)**

90-10011 -ENUS	1	KIT, M908 ISO-L1-GLO-ENUS .....	\$ 4,432.64
99-01097	1	Unlock Code, Matrix 908, VRA, Prescription Application .....	1,173.69
45-09050	1	Harness, Junction Box, Battery Ring .....	1,457.64
78-08115	1	Module, IC38, Single Chain, Single Section, 15' IBBC .....	5,068.12
35-02125	1	Valve, EXR-4, 20 GPM, 3 Sec, 3/#12 Port .....	1,514.76
16-05024	1	Kit, Rawson Gear Sensor, Belt .....	354.79
16-05025	1	Kit, Rawson Gear Sensor, Spinner .....	354.79
		<b>Total</b> .....	<b>\$ 14,356.43</b>

**EXAMPLE: TO ORDER AN ISOBUS TWO CHAIN/TWO SECTION SYSTEM WITH MATRIX 908 FOR A NON-ISOBUS TRACTOR (WITH VALVES OR SENSORS)**

90-10011 -ENUS	1	KIT, M908 ISO-L1-GLO-ENUS .....	\$ 4,432.64
99-01097	1	Unlock Code, Matrix 908, VRA, Prescription Application .....	1,173.69
45-09050	1	Harness, Junction Box, Battery Ring .....	1,457.64
78-08117	1	Module, IC38, One Bin, Two chains, 2 Sections, 15' IBBC .....	5,592.30
35-02125	2	Valve, EXR-4, 20 GPM, 3 Sec, 3/#12 Port .....	3,029.52
16-05024	2	Kit, Rawson Gear Sensor, Belt .....	709.58
16-05025	1	Kit, Rawson Gear Sensor, Spinner .....	354.79
		<b>Total</b> .....	<b>\$ 16,750.16</b>

**EXAMPLE: TO ORDER AN ISOBUS SINGLE CHAIN/SINGLE SECTION SYSTEM WITH MATRIX 908 FOR A NON-ISOBUS TRACTOR WITH HIGH ACCURACY PPP SOLUTION (WITH VALVES & SENSORS)**

90-10013 -ENUS	1	KIT, M908 ISO-L2+TSC-GLO-ENUS .....	\$ 6,000.37
99-01097	1	Unlock Code, Matrix 908, VRA, Prescription Application .....	1,173.69
99-01088*	1	SUBSCRIPTION, TERRASTAR-C PRO, 1 YEAR* .....	1,050.00
45-09050	1	Harness, Junction Box, Battery Ring .....	1,457.64
78-08115	1	Module, IC38, Single Chain, Single Section, 15' IBBC .....	5,068.12
35-02125	1	Valve, EXR-4, 20 GPM, 3 Sec, 3/#12 Port .....	1,514.76
16-05024	1	Kit, Rawson Gear Sensor, Belt .....	354.79
16-05025	1	Kit, Rawson Gear Sensor, Spinner .....	354.79
		<b>Total</b> .....	<b>\$ 16,974.16</b>

**EXAMPLE: TO ORDER AN ISOBUS TWO CHAIN/TWO SECTION SYSTEM WITH MATRIX 908 FOR A NON-ISOBUS TRACTOR WITH HIGH ACCURACY PPP SOLUTION (WITH VALVES & SENSORS)**

90-10013 -ENUS	1	KIT, M908 ISO-L2+TSC-GLO-ENUS .....	\$ 6,000.37
99-01097	1	Unlock Code, Matrix 908, VRA, Prescription Application .....	1,173.69
99-01088*	1	SUBSCRIPTION, TERRASTAR-C PRO, 1 YEAR* .....	1,050.00
45-09050	1	Harness, Junction Box, Battery Ring .....	1,457.64
78-08117	1	Module, IC38, One Bin, Two chains, 2 Sections, 15' IBBC .....	5,592.30
35-02125	2	Valve, EXR-4, 20 GPM, 3 Sec, 3/#12 Port .....	3,029.52
16-05024	2	Kit, Rawson Gear Sensor, Belt .....	709.58
16-05025	1	Kit, Rawson Gear Sensor, Spinner .....	354.79
		<b>Total</b> .....	<b>\$ 19,367.89</b>

\* Subscription is a net price so no additional discount is available.

\*\* Shut off valve manifolds are ordered from TeeJet Wheaton office. Additional fittings may be necessary.

ISOBUS APPLICATION CONTROLS



# **VALVES, SENSORS AND FLOW METERS**

**FLOW METERS- REGULATING VALVES- GPS SPEED SENSORS**

# FLOW METERS

## ELECTROMAGNETIC FLOW METERS



FM9380

## TURBINE FLOW METERS



FM838



57-10100



57-10122

## PADDLE WHEEL FLOW METERS



90-02310

### PART NO.

### DESCRIPTION

### U.S. DOLLARS

## ELECTROMAGNETIC FLOW METERS

### FM9380 ELECTROMAGNETIC FLOW METER (0.6-100 GPM; 2.3-380 LPM)

FM9380-F75	FM9380 Flow Meter, 75 Series Flange, 200 PSI, Deutsch 3 Pos/Skts .....	\$ 975.85
FM9380C-F75	FM9380 Flow Meter, 75 Series Flange, 200 PSI, Conxall 3 Pos/Pin .....	975.85

## TURBINE FLOW METERS

### FM838-Q TURBINE FLOW METER (0.5-10 GPM; 2.0-38 LPM)

FM838-Q	FM838 Flow Meter, TJ Quick Connect, 300 PSI, Deutsch 3 Pos/Skts .....	\$ 526.82
FM838C-Q	FM838 Flow Meter, TJ Quick Connect, 300 PSI, Conxall 3 Pos/Pin .....	526.82

Note: Please order TeeJet Quick Connect fittings and hose barbs through TeeJet Wheaton Facility.

### 801 FLOW METER (2-45GPM; 7.5-170LPM)

57-10100	801 Flow Meter, 50 Series Flange .....	\$ 694.95
90-50230	801 Flow Meter, Kit with 1" Hose Barbs .....	713.55
90-50272	801 Flow Meter, Kit with 1" Hose Barbs, Raven Conn .....	713.55

### 802 FLOW METER (3-130 GPM; 11-492 LPM)

57-10122	802 Flow Meter, 75 Series Flange .....	\$ 759.55
57-10125	802 Flow Meter, 75 Series Flange, Raven Conn.....	759.55
90-50277	802 Flow Meter, Kit w/1-1/2" Hose Barbs .....	793.57

### 801/802 SERVICE PARTS

90-02252	801 Flow Meter Insert, Repair, Kit .....	\$ 355.08
90-50256	802 Flow Meter Insert, Repair, Kit .....	355.08
16-00024	801/802 Flow Meter Sensor .....	245.30
16-00027	801/802 Flow Meter Sensor, Raven Conn .....	245.30
45-05315	801/802 Adapter Cable, Mid-Tech Controller .....	93.57

## PADDLE WHEEL FLOW METERS

### 10D FLOW METER (1-15 GPM; 3.8-55 LPM)

57-00079	10D Flow Meter, No Hose Barbs .....	\$ 437.99
90-02308	10D Flow Meter Kit, w/ 1/2" Hose Barbs .....	522.53

### 16D FLOW METER (2-17 GPM; 2-64 LPM)

57-00080	16D Flow Meter, No Hose Barbs .....	\$ 437.99
90-02310	16D Flow Meter Kit, w/ 1" Hose Barbs .....	522.53

### D SERIES SERVICE PARTS & FLANGE ADAPTER

57-00105	10D, 16D, 20D Flow Meter Insert .....	\$ 312.48
57-00084	50 Series Flange Adapter .....	115.65

Note: 20D (4-34 GPM), 26D (5-105 GPM) and 40D (10.6-264 GPM) are also available. Call for more details.

### EXTENSION CABLES

45-20017	3 Position DT 15' Flow Meter Extension .....	\$ 154.00
404-0045	3 Position Weatherpack 18' Flow Meter Extension .....	149.92
45-20254	3 Position DT 5' Speed Extension .....	78.67



SENSORS AND FLOW METERS

# REGULATING VALVES FOR TEEJET CONTROLS

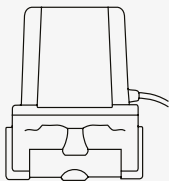
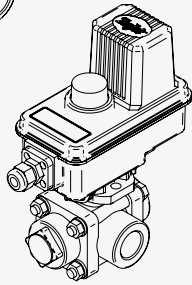
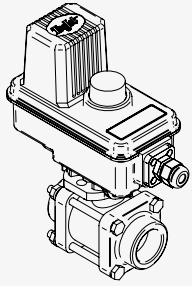

PART NO.	FLUID DELIVERY PART NO.	DESCRIPTION	U.S. DOLLARS
<b>3/4" VALVES</b>			
35-02115	344BPR-23-01CCS	Valve, Reg, 344BPR, 3/4" NPT, 344BRL-23-01CCS..	\$ 349.23
<b>1" VALVES</b>			
35-02099	344BRL-24-03CCS	Valve, 1" NPT 3 RPM .....	\$ 362.91
35-02087	344BRL-24-01CCS	Valve, Ball Linear Reg w/ 1" Fittings, 344BRL-24-	362.91
35-02140	344BRL-24S-03CCS	Valve, 3/4" 6 Sec 1" NPTPP/SS, S-F-AMP .....	432.12
35-02094	344BPR-24-06CCS	Valve, Regulating, 1" 12 GPM 6 Second.....	349.23
35-02089	344BPR-24-01CCS	Valve, Regulating, Low Flow1" .....	349.23
<b>1 1/4" VALVES</b>			
35-02142	346BPR-25-06CCS	Valve, TJ Regulating, 346 BPR, 1-1/4" NPT.....	\$ 742.04
<b>50 SERIES VALVES</b>			
35-02112	344BRL-2F-03CCS	Valve, Reg. w/Flange, 3 RPM .....	\$ 362.91
35-02132	344BRL-2F-03CCS	Valve, Reg, 346BR, FLNG 6 Sec .....	742.04
35-02141	346BPR-2F-06CCS	Valve, TJ Regulating, 346 BPR, 50 Series Flange .	742.04
<b>BUTTERFLY</b>			
35-50029	244C-3/4 21773-244C-3/4	Valve, Reg. 244C-3/4, 21773-244C-3/4.....	\$ 185.83
35-50049	244C-3/4 AA244C-3/4	Valve, Reg. 244C-3/4 AA244C-3/4 (w/o CONN)...	168.39

# REGULATING VALVES FOR ARC, TASC, DCM RATE CONTROLLERS

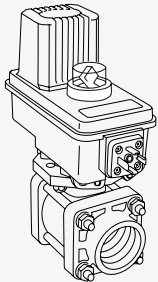

PART NO.	FLUID DELIVERY PART NO.	DESCRIPTION	U.S. DOLLARS
<b>1" REGULATING VALVES</b>			
35-02083	344BR-34S-06CUG	Valve, Autorange, 1" PP, 3 Sec B Series.....	\$ 508.10
35-02085	344BR-24S-06CUK	Valve, Control, 1" PP, 3 Sec B Series .....	432.12
879-0003	N/A	Valve, Autorange, 1" SST, # 50 Wiring, 1.5 Second .....	1,707.43
<b>1 1/2 "REGULATING VALVES</b>			
35-02084	346BR-36-06CUG	Valve, Autorange, 1-1/2" PP, 3 Sec B Series.....	742.04
35-02086	346BR-26-06CUK	Valve, Control, 1- 1/2" PP, 3 Sec B Series .....	742.04
879-0004	N/A	Valve, Autorange, 1-1/2" SST, # 50 Wiring, 3 Second.....	2,530.69
35-02146	346BPR-36-06CUK	Valve, MT 3-Way, 346 BPR, 1-1/2" NPT .....	742.04
<b>OTHER VALVES</b>			
879-0002	N/A	Valve, Autorange, 3/4", SST, #50 Wiring, 1.5 Second .....	1,643.15
35-02144	346BPR-3F-06CUK	Valve, MT 3-Way, 346 BPR, 50 Series Flange.....	742.04
35-02145	346BPR-35-06CUK	Valve, MT 3-Way, 346 BPR, 1-1/4" NPT .....	742.04

# EXR-IV HYDRAULIC CONTROL VALVES

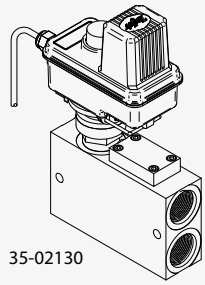

PART NO.	DESCRIPTION	U.S. DOLLARS
35-02130	Valve, 50 GPM (190 LPM), 3-port, 3 Second .....	\$ 1,761.48
35-02129	Valve, 50 GPM (190 LPM) w/ Pressure Relief, 3-port, 3 Second .....	2,010.03
35-02128	Valve, 30 GPM (114 LPM), 3-port, 3 Second .....	1,514.76
35-02127	Valve, 30 GPM (114 LPM) w/ Pressure Relief, 3-port, 3 Second .....	2,010.03
35-02149	Valve, 20 GPM (75 LPM), 3-port w/ Pressure Relief, 3 Second .....	2,010.03
35-02126	Valve, 20 GPM (75 LPM), 2-port White Motor Mount w/ Pressure Relief, 3 Second .....	2,503.69
35-02125	Valve, 20 GPM (75 LPM), 3-port, 3 Second .....	1,514.76
35-02124	Valve, 15 GPM (57 LPM), 2-port w/ LS, 7 Second .....	1,467.48
35-02123	Valve, 15 GPM (57 LPM), 3-port, 3 Second .....	1,514.76
35-02122	Valve, 13.8 GPM (52 LPM), 2-port, 7 Second .....	2,503.69
35-02121	Valve, 13 GPM (49 LPM), 3-port, 3 Second .....	1,910.31
35-02120	Valve, 8 GPM (30 LPM), 2-port White Motor Mount w/ Pressure Relief, 3 Second .....	2,503.69
35-02119	Valve, 8 GPM (30 LPM), 3-port, 3 Second .....	1,514.76
35-02118	Valve, 5 GPM (19 LPM), 2-port w/ Press Comp & LS, 7 Second .....	1,514.76
35-02117	Valve, 5 GPM (19 LPM), 2-port w/ Press Comp & LS, 3 Second .....	1,514.76

# GPS SPEED SENSORS

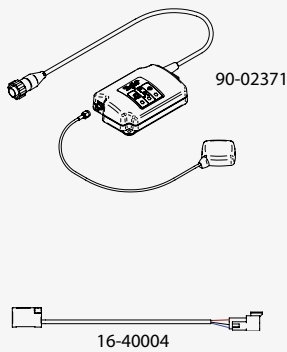

PART NO.	DESCRIPTION	U.S. DOLLARS
<b>GPS SPEED SENSORS</b>		
90-02371	Kit, GPS Speed Sensor for Mid-Tech Controls .....	\$ 742.23
90-02386	Kit, GPS Speed Sensor for TeeJet Controls .....	742.23
90-02404	Kit, GPS Speed Sensor for Raven Controls .....	742.23
90-02868	Kit, GPS Speed Sensor for Radion Control .....	742.23
<b>SPEED SENSORS</b>		
16-40003	Sensor, Wheel Speed .....	\$ 210.09
16-40004	Sensor, Proximity Speed .....	147.24
16-40007	Sensor, Wheel Speed Kit ( Sensor, 2 Magnets, and Brackets) .....	532.03
16-40012	Sensor, Wheel Speed Kit ( Sensor, 4 Magnets, and Brackets) .....	684.48
16-40013	Wheel, Sensor Bracket Assembly .....	117.64
64-50014	Wheel Magnet Assembly .....	53.95
16-40019	Sensor, Proximity, w/ Mid-Tech Radar Connector .....	188.55
<b>EXTENSION CABLES</b>		
45-20017	3 Position DT 15' Speed Extension .....	\$ 154.00
45-20254	3 Position DT 5' Speed Extension .....	78.67
45-05440	4 Position AMP 6' Speed Extension .....	206.31

# PRESSURE SENSORS FOR TEEJET CONTROLS

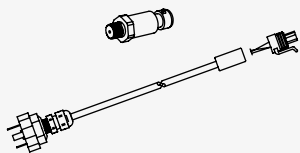

PART NO.	DESCRIPTION	U.S. DOLLARS
<b>PRESSURE SENSORS</b>		
90-02476	Kit, Pressure Sensor 0-145 PSI/0-10 Bar .....	\$ 426.69
90-02482	Kit, Pressure Sensor 0-363 PSI/0-25 Bar .....	423.55
16-05015	Pressure Sensor 0-145 PSI/ 0-10 Bar .....	328.59
16-05016	Pressure Sensor 0-363 PSI/0-25 Bar .....	336.00



# **DYNAJET<sup>®</sup> NOZZLE CONTROL SYSTEM**

**DYNAJET FLEX 7140-DYNAJET IC7140 HYBRID  
-DYNAJET IC7140 DUAL DRIVERS**



# DYNAJET<sup>®</sup> NOZZLE CONTROL SYSTEM



DynaJet automatically controls the pressure and droplet size across a wide range of speeds, allowing you to choose the optimum speed while maintaining consistent droplet size.

Just program your droplet size from the cab and go. The same droplet size throughout the field. The same spray quality.

## DYNAJET COMPONENTS

DynaJet can be installed on all types of sprayers whether they are trailed or self-propelled, with front or back boom, new models or sprayers currently in use.



**DYNAJET VALVE  
ON INDIVIDUAL NOZZLE BODY**



**ELECTRONIC  
CONTROL UNIT (ECU)**



**ISOBUS TERMINAL**



**HARNESSES  
INCLUDING NOZZLE DRIVERS**

FEATURES	DYNAJET
20 Hz PWM frequency	✓
Operation modes	✓
Pressure selection	✓
Droplet size selection	✓
Immediate on/off reaction at the nozzle	✓
Real time droplet size spray quality feedback	✓
Up-to-date droplet size data integrated in console	✓
Active droplet size section (buffer zones)	✓
Systems diagnostics and solenoid fault detection	✓
Dual nozzle control	✓
ISOBUS compatibility	✓
Turn compensation	✓
Individual nozzle control*	✓
VRA Functionalities*	✓
Spot Spraying compatibility*	✓

DYNAJET NOZZLE CONTROL

## DYNAJET SPRAY TIPS

- APTJ AccuPulse<sup>®</sup> TwinJet<sup>®</sup>
- TT Turbo TeeJet<sup>®</sup>
- TTJ60 Turbo TwinJet<sup>®</sup>
- AITTJ60 Air Induction Turbo TwinJet<sup>®</sup>
- XR TeeJet<sup>®</sup>
- AI Air induction
- TTI Turbo TeeJet<sup>®</sup> Induction
- TTJ60 TTI TwinJet<sup>®</sup>
- TJ60 TwinJet<sup>®</sup>



\*Features are available with unlock code and only in combination with IC45 Spray Job computer

# DYNAJET<sup>®</sup> NOZZLE CONTROL SYSTEM

DYNAJET NOZZLE CONTROL

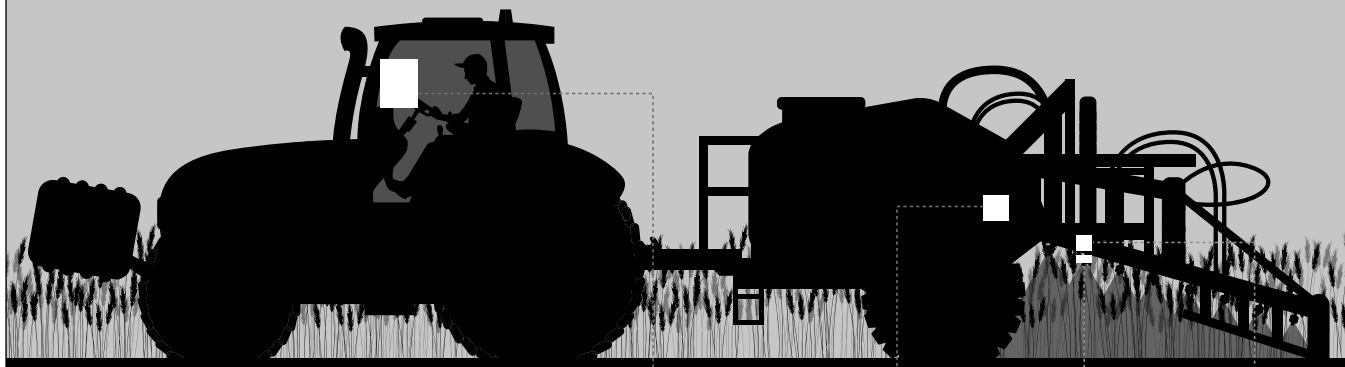

## DYNAJET IC7140 ISOBUS



MATRIX 908



DYNAJET IC7140 ECU



E-CHEMSAVER

DUAL DRIVER DB2B

## DYNAJET IC7140 HYBRID



MATRIX 908



DYNAJET 7140 ECU



E-CHEMSAVER



DRIVER

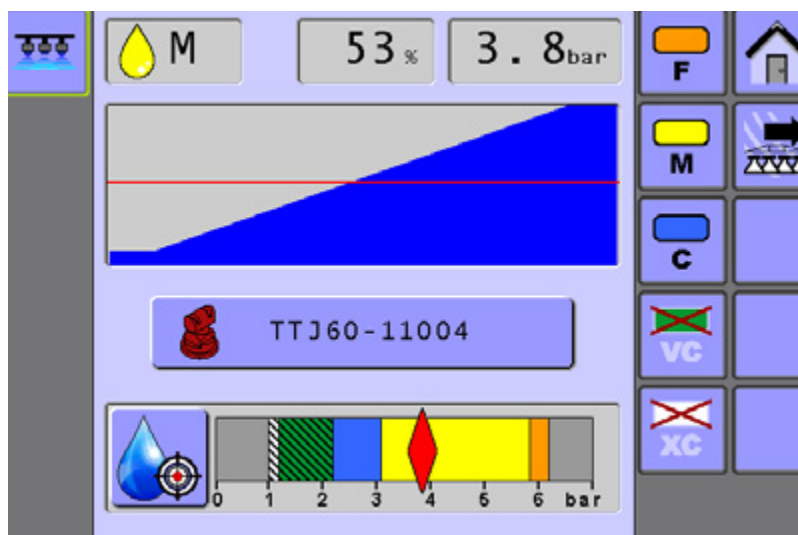

Screenshot of the DynaJet IC7140 ISOBUS.

# DYNAJET® FLEX 7140 NOZZLE CONTROL SYSTEM

DynaJet Flex 7140 is a stand alone system that can be retrofitted to existing sprayers using automatic rate control systems.

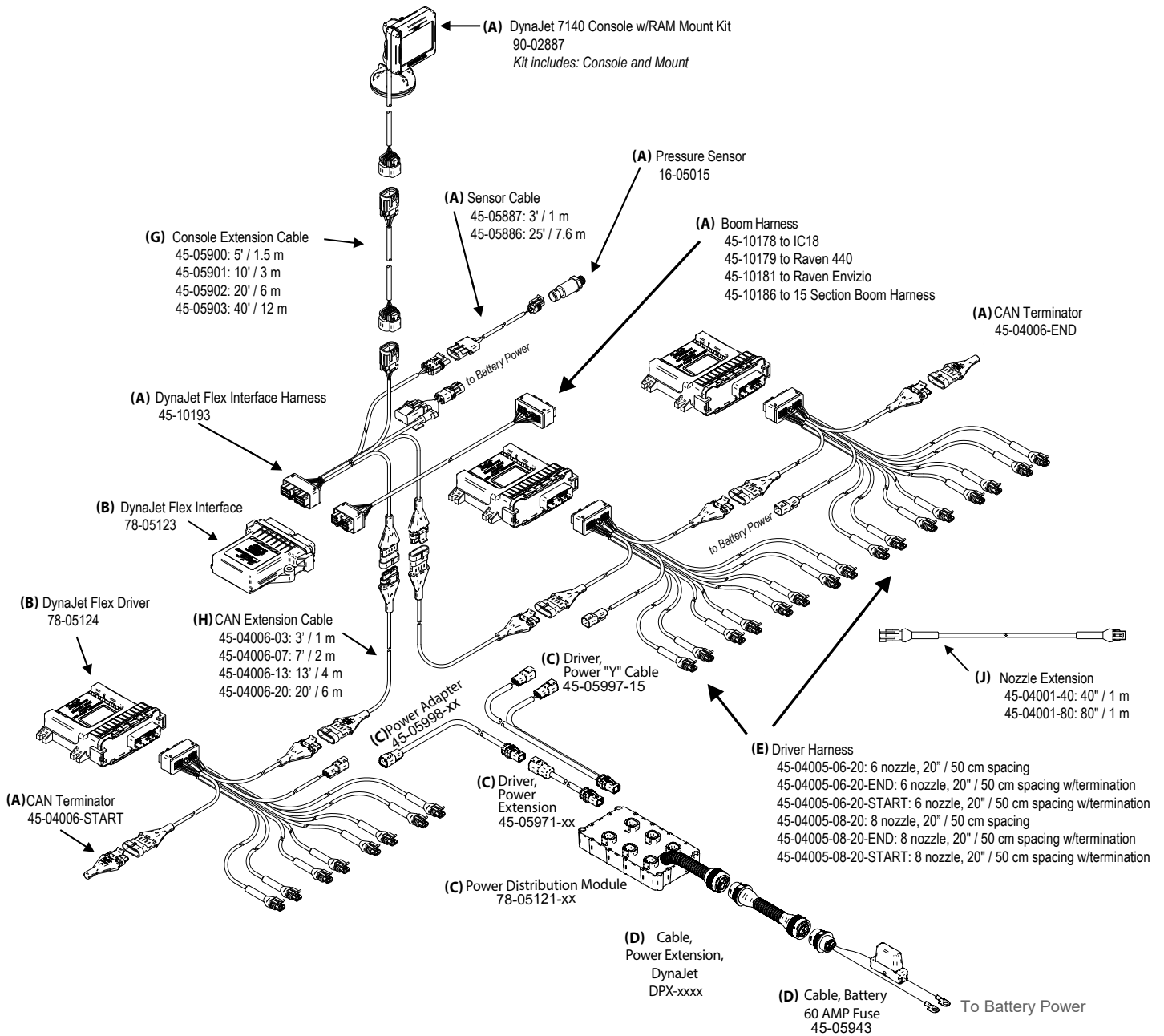

DYNAJET NOZZLE CONTROL

# DYNAJET® FLEX 7140 NOZZLE CONTROL SYSTEM

DYNAJET NOZZLE CONTROL

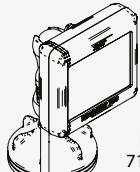

Kit, DynaJet 7140 Console

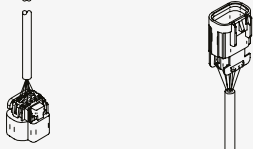

Cable, Console Extension 45-059xx

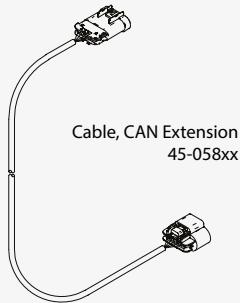

Cable, CAN Extension 45-058xx

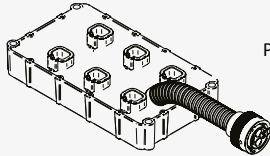

Power Distribution Module  
3pos. 78-05121-03  
4pos. 78-05121-04  
5pos. 78-05121-05  
6pos. 78-05121-06

Optional  
Power Extension  
5' 45-05971-05  
10' 45-05971-10  
20' 45-05971-20  
30' 45-05971-30  
40' 45-05971-40  
50' 45-05971-50

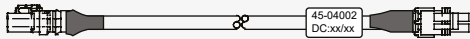
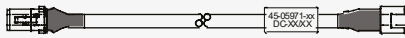

Adapter 4 DTP to 2 WP  
6' 45-04002

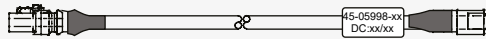

Power Adapter  
1' 45-05998-01  
5' 45-05998-05  
10' 45-05998-10

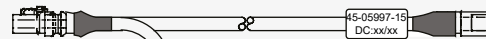

Power "Y"  
4 DTP to two DTP  
15' 45-05997-15

## CONSOLE AND SYSTEM COMPONENTS (A)

PART NO.	DESCRIPTION	U.S. DOLLARS
90-02887	Kit, DynaJet 7140 Console, w/Suction Mount. ....	\$ 981.80
75-30119	Console, DynaJet Flex 7140. ....	947.76
50-05222	Dust Cap, CINCH 18POS. ....	66.20
45-10193	Harness, DynaJet Interface, AMPSS 1.5. ....	574.49
45-10186	Harness, Boom, DynaJet Interface, 15 Section. ....	183.44
16-05015	Pressure Sensor, 10 BAR. ....	345.02
45-05887	Cable, Pressure Sensor, 3'. ....	51.82
45-05886	Cable, Pressure Sensor, 25'. ....	111.30
45-04006-START	Terminator, Sensor CAN START, Female. ....	86.38
45-04006-END	Terminator, Sensor CAN END, Male. ....	86.38

## INTERFACES, DRIVER MODULES POWER DISTRIBUTION MODULES (B)

PART NO.	DESCRIPTION	U.S. DOLLARS
78-05123	Module, DynaJet High Flow Interface. ....	\$ 714.59
78-05124	Driver, 8 Output DynaJet. ....	1,635.54
78-05121-03	Power Distribution Module, 3- OUTPUTS. ....	526.89
78-05121-04	Power Distribution Module, 4- OUTPUTS. ....	611.14
78-05121-05	Power Distribution Module, 5- OUTPUTS. ....	695.39
78-05121-06	Power Distribution Module, 6- OUTPUTS. ....	795.56

## POWER DISTRIBUTION MODULE CABLES TO DYNAJET DRIVERS AND INTERFACE POWER (C)

PART NO.	DESCRIPTION	U.S. DOLLARS
45-04002	Cable PWR, 4 POS DTP TO 2 POS WP TWR 6'. ....	\$ 95.41
45-05997-15	Cable PWR Y, 10GA, 4 POS DTP To 2 - 2 POS DTP. ....	293.04
45-05998-01	Cable PWR, 4 POS DTP to 2 POS DTP. ....	112.87
45-05998-05	Cable PWR, 4 POS DTP to 2 POS DTP. ....	175.17
45-05998-10	Cable PWR, 4 POS DTP to 2 POS DTP. ....	204.87

## BATTERY POWER CABLES TO POWER DISTRIBUTION MODULE (D)

PART NO.	DESCRIPTION	U.S. DOLLARS
401-0016	Cable Power, 1 Lead, 2'/0.6m. ....	\$ 84.80
DPX-0300	Cable, Power Extension, DynaJet, 10'/3m. ....	324.06
DPX-0620	Cable, Power Extension, DynaJet, 20'/6m. ....	421.82
DPX-0910	Cable, Power Extension, DynaJet, 30'/9m. ....	519.60
DPX-1200	Cable, Power Extension, DynaJet, 40'/12.2m. ....	610.37
45-05943	Cable Battery, 6ga/13.3mm to 2 POS DT, 60 Amp Fuse. ....	165.53
90-02885	Kit, Dustcap DT Plug SZ18. ....	83.51
90-02886	Kit, Dustcap DT RCPT SZ18. ....	53.58

# DYNAJET® FLEX 7140 NOZZLE CONTROL SYSTEM

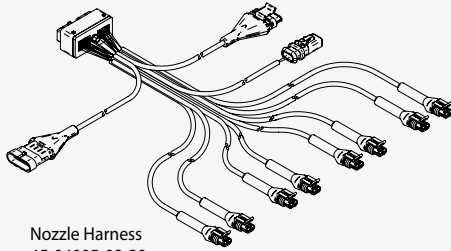

Nozzle Harness  
45-04005-08-20

## NOZZLE HARNESS 20" / 50 CM SPACING (E)

PART NO.	DESCRIPTION	U.S. DOLLARS
45-04005-06-20	Harness, Nozzle, DynaJet, AMPSS 1.5, 20"/50 cm, 6 Nozzle .	\$ 542.15
45-04005-06-20-START	Harness, Nozzle, DynaJet, AMPSS 1.5, 20"/50 cm, 6 NZ, W/ Start Term . . . . .	570.83
45-04005-06-20-END	Harness, Nozzle, DynaJet, AMPSS 1.5, 20"/50 cm, 6 NZ, W/ Start Term . . . . .	570.83
45-04005-08-20	Harness, Nozzle, DynaJet, AMPSS 1.5, 20"/50 cm, 8 Nozzle .	619.60
45-04005-08-20-START	Harness, Nozzle, DynaJet, AMPSS 1.5, 20"/50 cm, 8 NZ, W/ Start Term . . . . .	674.39
45-04005-08-20-END	Harness, Nozzle, DynaJet, AMPSS 1.5, 20"/50 cm, 8 NZ, W/ End Term . . . . .	674.39

## NOZZLE SOLENOIDS (F)

PART NO.	DESCRIPTION	U.S. DOLLARS
115880-2-12*	115880-2-12 e-Chemsaver® . . . . .	\$ 267.40
115880-1-12*	115880-1-12 e-Chemsaver® . . . . .	267.40
115880-4-12*	115880-4-12 e-Chemsaver® . . . . .	267.40

\*Please order separately with TeeJet Fluid Delivery items

## CONSOLE EXTENSION CABLES (G)

PART NO.	DESCRIPTION	U.S. DOLLARS
45-05900	Cable, Extension Console, 5'/ 1.5m . . . . .	\$ 153.50
45-05901	Cable, Extension Console, 10'/ 3m . . . . .	172.69
45-05902	Cable, Extension Console, 20'/6m . . . . .	222.54
45-05903	Cable, Extension Console, 40'/ 12.2m . . . . .	329.91

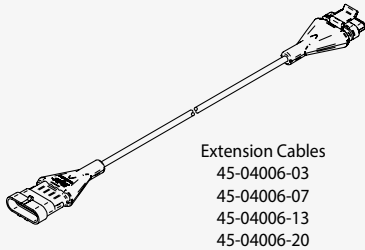

Extension Cables  
45-04006-03  
45-04006-07  
45-04006-13  
45-04006-20

## SENSOR CAN EXTENSION CABLES (H)

PART NO.	DESCRIPTION	U.S. DOLLARS
45-04006-03	Sensor CAN Extension, 3'/ 1m . . . . .	\$ 111.19
45-04006-07	Sensor CAN Extension, 7'/ 2m . . . . .	117.97
45-04006-13	Sensor CAN Extension, 13'/4m . . . . .	131.60
45-04006-20	Sensor CAN Extension, 20'/ 6m . . . . .	145.18

## POWER EXTENSION CABLES (I)

PART NO.	DESCRIPTION	U.S. DOLLARS
45-05160	Cable, Power Ext. 10'; 2 POS WP . . . . .	\$ 72.40
45-05161	Cable, Power Ext. 20'; 2 POS WP . . . . .	137.57
45-05162	Cable, Power Ext. 30'; 2 POS WP . . . . .	165.90
45-05971-05	Cable, PDM Power Extension, 4 POS DTP, 10 GA, 5'/ 1.5m . .	135.42
45-05971-10	Cable, PDM Power Extension, 4 POS DTP, 10 GA, 10'/ 3m . .	165.52
45-05971-20	Cable, PDM Power Extension, 4 POS DTP, 10 GA, 20'/ 6m . .	245.60
45-05971-30	Cable, PDM Power Extension, 4 POS DTP, 10 GA, 30'/ 9m . .	327.41
45-05971-40	Cable, PDM Power Extension, 4 POS DTP, 10 GA, 40'/ 12.2m .	394.82
45-05971-50	Cable, PDM Power Extension, 4 POS DTP, 10 GA, 50'/ 15.2m .	477.68

## OPTIONAL NOZZLE HARNESS (J)

PART NO.	DESCRIPTION	U.S. DOLLARS
45-04001-40	Cable, EXT, 40"/ 1m, 2POS, AMPSS1.5 . . . . .	\$ 63.12
45-04001-80	Cable, EXT, 80"/ 2m, 2POS, AMPSS1.5 . . . . .	67.52

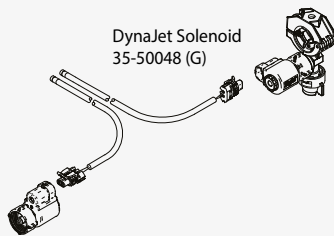

DynaJet Solenoid  
35-50048 (G)

# DYNAJET® FLEX 7140 NOZZLE CONTROL SYSTEM

## DYNAJET SYSTEM ORDERING EXAMPLE: 100'/30 M BOOM, 9 SECTIONS 20"/50 CM SPACING (60 NOZZLES)

### STEP 1: CHOOSE CONSOLE AND SYSTEM COMPONENTS

QTY	PART NO.	DESCRIPTION	U.S. DOLLARS
1	90-02887	Kit, DynaJet 7140 Console, w/Suction Mount.....	\$ 981.80
1	45-10193	Harness, DynaJet Interface, AMPSS 1.5.....	574.49
1	45-10186	Harness, Boom, DynaJet Interface, 15 Section.....	183.44
1	16-05015	Sensor Pressure, 10 Bar.....	345.02
1	45-05887	Cable, Pressure Sensor, 3'.....	51.82
		<b>Total.....</b>	<b>\$ 2,136.57</b>

### STEP 2: CHOOSE INTERFACES, DRIVER MODULES AND POWER DISTRIBUTION MODULES

QTY	PART NO.	DESCRIPTION	U.S. DOLLARS
1	78-05123	Interface, DynaJet 7140.....	\$ 714.59
9	78-05124	Driver, DynaJet.....	14,719.86
1	78-05121-05	Power Distribution Module, 5 - OUTPUTS.....	695.39
		<b>Total.....</b>	<b>\$ 16,129.84</b>

### STEP 3: CHOOSE POWER DISTRIBUTION MODULE CABLES TO DYNAJET DRIVERS AND INTERFACE POWER

QTY	PART NO.	DESCRIPTION	U.S. DOLLARS
4	45-05997-15	Cable PWR Y, 10GA, 4 POS DTP To 2 - 2 POS DTP 3'/1m & 15'/4.5m.....	\$ 1,172.16
1	45-05998-05	Cable PWR, 4 POS DTP to 2 POS DTP 5'/1.5m.....	175.17
		<b>Total.....</b>	<b>\$ 1,347.33</b>

### STEP 4: CHOOSE BATTERY POWER CABLES TO POWER DISTRIBUTION MODULE

QTY	PART NO.	DESCRIPTION	U.S. DOLLARS
1	401-0016	Cable Power, 1 Lead, 2'/0.6m.....	\$ 84.80
1	DPX-0910	Cable, Power Extension, DynaJet, 30'/9m.....	519.60
1	45-05943	Cable Battery, 6ga/13.3mm to 2 POS DT, 60 amp fuse.....	165.53
		<b>Total.....</b>	<b>\$ 769.93</b>

### STEP 5: CHOOSE NOZZLE HARNESS

QTY	PART NO.	DESCRIPTION	U.S. DOLLARS
4	45-04005-06-20	Harness, Nozzle, DynaJet, AMPSS 1.5, 20"/50cm, 6 Nozzle.....	\$ 2,168.60
1	45-04005-06-20-START	Harness, Nozzle, DynaJet, AMPSS 1.5, 20"/50cm, 6NZ, W/START TERM.....	570.83
1	45-04005-06-20-END	Harness, Nozzle, DynaJet, AMPSS 1.5, 20"/50cm, 6NZ, W/END TERM.....	570.83
3	45-04005-08-20	Harness, Nozzle, DynaJet, AMPSS 1.5, 20"/50CM, 8 Nozzle.....	1,858.80
		<b>Total.....</b>	<b>\$ 5,169.06</b>

### STEP 6: CHOOSE NOZZLE SOLENOIDS

QTY	PART NO.	DESCRIPTION	U.S. DOLLARS
60	115880-2-12*	115880-2-12 e-Chemsaver®.....	\$16,044.00
		<b>Total.....</b>	<b>\$16,044.00</b>

\*Please order separately with TeeJet Fluid Delivery Items

### STEP 7: CHOOSE CONSOLE EXTENSION CABLES

QTY	PART NO.	DESCRIPTION	U.S. DOLLARS
1	45-05901	Cable, EXT. Sentry 6140, 10'.....	\$ 172.69
		<b>Total.....</b>	<b>\$ 172.69</b>

DYNAJET NOZZLE CONTROL



# DYNAJET® FLEX 7140 NOZZLE CONTROL SYSTEM

## DYNAJET SYSTEM ORDERING EXAMPLE: 100'/30 M BOOM, 9 SECTIONS 20"/50 CM SPACING (60 NOZZLES)

### STEP 8: CHOOSE SENSOR CAN EXTENSION CABLES

QTY			
2	45-04006-13	Sensor CAN EXT. 13'/ 4m .....	\$ 263.20
2	45-04006-20	Sensor CAN EXT. 20'/ 6m .....	290.36
<b>Total .....</b>			<b>\$ 553.56</b>

### STEP 9: CHOOSE POWER EXTENSION CABLES

QTY			
1	78-05123	Interface, DynaJet 7140 .....	\$ 714.59
2	78-05124	Driver, DynaJet .....	3,271.08
2	78-05121-05	Power Distribution Module, 5 - OUTPUTS .....	1,390.78
<b>Total .....</b>			<b>\$ 5,376.45</b>

### STEP 10: CHOOSE OPTIONAL NOZZLE EXTENSION CABLES

QTY			
3	45-05997-15	Cable, Extension, 40"/ 1m, 2POS, AMPSS1.5 .....	\$ 879.12
<b>Total .....</b>			<b>\$ 879.12</b>
<b>Grand Total for Complete DynaJet Flex 7140 System .....</b>			<b>\$ 48,578.55</b>

DYNAJET NOZZLE CONTROL

# DYNAJET® IC7140 HYBRID NOZZLE CONTROL SYSTEM

DynaJet IC7140 Hybrid utilizes an ISOBUS ECU (IC7140). The system can be retrofitted to existing sprayers that use ISOBUS UT's.

DYNAJET NOZZLE CONTROL

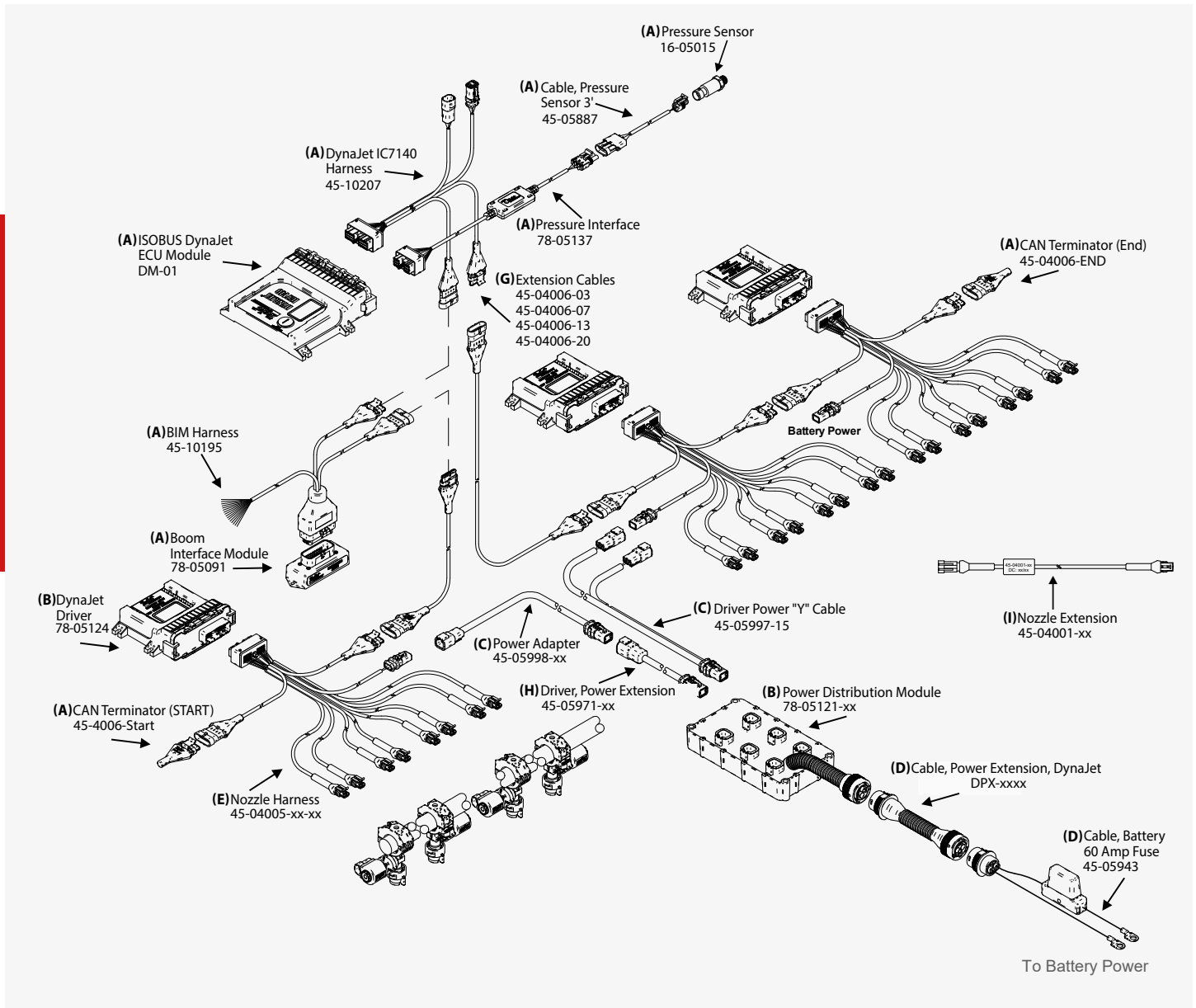

# DYNAJET® IC7140 HYBRID NOZZLE CONTROL SYSTEM

Module, DynaJet IC7140  
DM-01

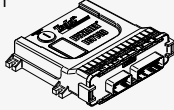

Cable, Console Extension  
45-059xx

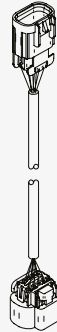

Cable, CAN Extension  
45-058xx

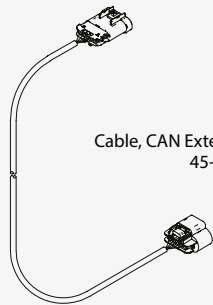

Power Distribution Module  
3pos. 78-05121-03  
4pos. 78-05121-04  
5pos. 78-05121-05

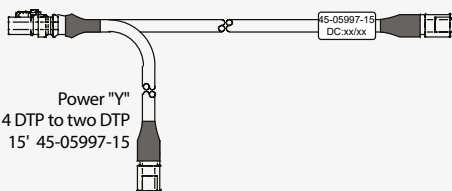
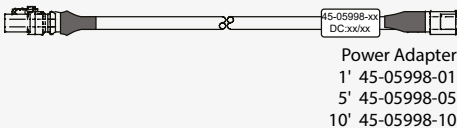
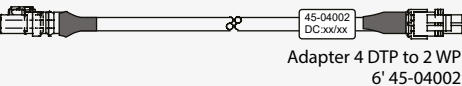
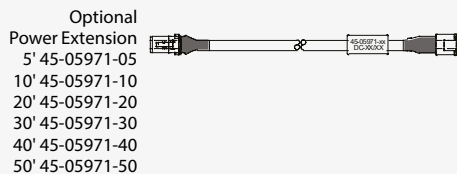
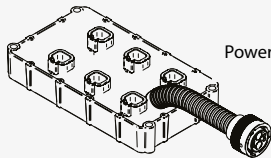

## SYSTEM COMPONENTS (A)

PART NO.	DESCRIPTION	U.S. DOLLARS
DM-01	Module, DynaJet IC7140 .....	\$ 1,365.09
45-10207	Harness, Hybrid IC7140, AMPSS 1.5 W/DT Connectors .....	440.79
45-10195	Harness, BIM, 15 Section, AMPSS 1.5 Connectors.....	398.97
16-05015	Sensor Pressure, 10 Bar.....	345.02
45-05887	Cable, Pressure Sensor, 3'.....	51.82
45-05886	Cable, Pressure Sensor, 25' .....	111.30
45-04006-START	Terminator, Sensor CAN START, Female .....	86.38
45-04006-END	Terminator, Sensor CAN END, Male .....	86.38
78-05137	IC7140 Pressure to CAN Interface .....	352.20
78-05091	Module, Boom Interface .....	469.94

## DRIVER MODULES AND POWER DISTRIBUTION MODULES (B)

PART NO.	DESCRIPTION	U.S. DOLLARS
78-05124	Driver, DynaJet .....	\$ 1,635.54
78-05121-03	Power Distribution Module, 3-Outputs.....	526.89
78-05121-04	Power Distribution Module, 4-Outputs.....	611.14
78-05121-05	Power Distribution Module, 5-Outputs.....	695.39
78-05121-06	Power Distribution Module, 6-Outputs.....	795.56

## POWER DISTRIBUTION MODULE CABLES TO DYNAJET DRIVERS AND INTERFACE POWER (C)

PART NO.	DESCRIPTION	U.S. DOLLARS
45-04002	Cable PWR, 4 POS DTP TO 2 POS WP TWR 6',.....	\$ 95.41
45-05997-15	Cable PWR Y, 10GA, 4 POS DTP To 2 - 2 POS DTP .....	293.04
45-05998-01	Cable PWR, 4 POS DTP to 2 POS DTP .....	112.87
45-05998-05	Cable PWR, 4 POS DTP to 2 POS DTP .....	175.17
45-05998-10	Cable PWR, 4 POS DTP to 2 POS DTP .....	204.87

## BATTERY POWER CABLES TO POWER DISTRIBUTION MODULE (D)

PART NO.	DESCRIPTION	U.S. DOLLARS
401-0016	Cable Power, 1 Lead, 2' / 0.6m .....	\$ 84.80
DPX-0300	Cable, Power Extension, DynaJet, 10' / 3m .....	324.06
DPX-0620	Cable, Power Extension, DynaJet, 20' / 6m .....	421.82
DPX-0910	Cable, Power Extension, DynaJet, 30' / 9m .....	519.60
DPX-1200	Cable, Power Extension, DynaJet, 40' / 12.2m. ....	610.37
45-05943	Cable Battery, 6ga / 13.3mm to 2 POS DT, 60 Amp Fuse .....	165.53
90-02885	Kit, Dustcap DT Plug SZ18 .....	83.51
90-02886	Kit, Dustcap DT RCPT SZ18.....	53.58

## NOZZLE HARNESS 20" / 50 CM SPACING (E)

PART NO.	DESCRIPTION	U.S. DOLLARS
45-04005-06-20	Harness, Nozzle, DynaJet, AMPSS 1.5, 20" / 50 cm, 6 .....	\$ 542.15
45-04005-06-20-START	Harness, Nozzle, DynaJet, AMPSS 1.5, 20" / 50 cm, 6 NZ, W/ Start Term .....	570.83
45-04005-06-20-END	Harness, Nozzle, DynaJet, AMPSS 1.5, 20" / 50 cm, 6 NZ, W/ Start Term .....	570.83
45-04005-08-20	Harness, Nozzle, DynaJet, AMPSS 1.5, 20" / 50 cm, 8 .....	619.60
45-04005-08-20-START	Harness, Nozzle, DynaJet, AMPSS 1.5, 20" / 50 cm, 8 NZ, W/ Start Term .....	674.39
45-04005-08-20-END	Harness, Nozzle, DynaJet, AMPSS 1.5, 20" / 50 cm, 8 NZ, W/ End Term .....	674.39

# DYNAJET® IC7140 HYBRID NOZZLE CONTROL SYSTEM

DYNAJET NOZZLE CONTROL

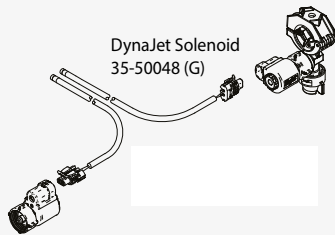
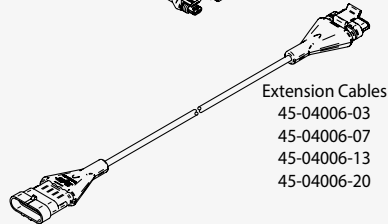
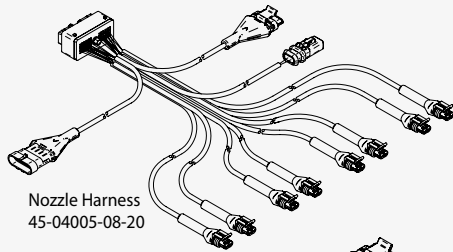

## NOZZLE SOLENOIDS (F)

PART NO.	DESCRIPTION	U.S. DOLLARS
115880-2-12*	115880-2-12 e-Chemsaver®	\$ 267.40
115880-1-12*	115880-1-12 e-Chemsaver®	267.40
115880-4-12*	115880-4-12 e-Chemsaver®	267.40

\*Please order separately with TeeJet Fluid Delivery items

## SENSOR CAN EXTENSION CABLES (H)

PART NO.	DESCRIPTION	U.S. DOLLARS
45-04006-03	Sensor CAN Extension, 3'/ 1m	\$ 111.19
45-04006-07	Sensor CAN Extension, 7'/ 2m	117.97
45-04006-13	Sensor CAN Extension, 13'/4m	131.60
45-04006-20	Sensor CAN Extension, 20'/ 6m	145.18

## POWER EXTENSION CABLES (I)

PART NO.	DESCRIPTION	U.S. DOLLARS
45-05160	Cable, Power Ext. 10'; 2 POS WP	\$ 72.40
45-05161	Cable, Power Ext. 20'; 2 POS WP	137.57
45-05162	Cable, Power Ext. 30'; 2 POS WP	165.90
45-05971-05	Cable, PDM Power Extension, 4 POS DTP, 10 GA, 5'/ 1.5m..	135.42
45-05971-10	Cable, PDM Power Extension, 4 POS DTP, 10 GA, 10'/ 3m...	165.52
45-05971-20	Cable, PDM Power Extension, 4 POS DTP, 10 GA, 20'/ 6m ..	245.60
45-05971-30	Cable, PDM Power Extension, 4 POS DTP, 10 GA, 30'/ 9m ..	327.41
45-05971-40	Cable, PDM Power Extension, 4 POS DTP, 10 GA, 40'/ 12.2m .	394.82
45-05971-50	Cable, PDM Power Extension, 4 POS DTP, 10 GA, 50'/ 15.2m .	477.68

## OPTIONAL NOZZLE HARNESS (J)

PART NO.	DESCRIPTION	U.S. DOLLARS
45-04001-40	Cable, EXT, 40"/ 1m, 2POS, AMPSS1.5	\$ 63.12
45-04001-80	Cable, EXT, 80"/ 2m, 2POS, AMPSS1.5	67.52

# DYNAJET® IC7140 HYBRID NOZZLE CONTROL SYSTEM

## DYNAJET IC7140 SYSTEM HYBRID ORDERING EXAMPLE 100' / 30 M BOOM, 5 SECTIONS 20"/50 CM SPACING (60 NOZZLES)

### STEP 1: CHOOSE SYSTEM COMPONENTS

QTY	PART NO.	DESCRIPTION	U.S. DOLLARS
1	DM-01	Module, DynaJet IC7140.....	\$ 1,365.09
1	45-10207	Harness, Hybrid, IC7140, AMPSS 1.5 W/DT Connectors .....	440.79
1	45-05887	Cable, Pressure Sensor, 3' .....	51.82
1	78-05137	IC7140 Pressure to CAN Interface.....	352.20
1	16-05015	Sensor Pressure, 10 Bar .....	345.02
1	78-05091	Module, Boom Interface.....	469.94
1	45-10195	Harness, BIM, 15 Section, AMSS 1.5 Connectors.....	398.97
1	45-04006-START	Terminator, Sensor CAN Start, Female.....	86.38
1	45-04006-END	Terminator, Sensor CAN End, Male.....	86.38
<b>Total .....</b>			<b>\$ 3,596.59</b>

### STEP 2: CHOOSE DRIVER MODULES AND POWER DISTRIBUTION MODULES

QTY	PART NO.	DESCRIPTION	U.S. DOLLARS
9	78-05124	Driver, DynaJet .....	\$14,719.86
1	78-05121-05	Power Distribution Module, 5 - Outputs.....	695.39
<b>Total .....</b>			<b>\$ 15,415.25</b>

### STEP 3: CHOOSE POWER DISTRIBUTION MODULE CABLES TO DYNAJET DRIVERS AND INTERFACE POWER

QTY	PART NO.	DESCRIPTION	U.S. DOLLARS
4	45-05997-15	Cable, Power Y, 10GA, 4 POS DTP To 2 - 2 POS DTP 3'/1m & 15'/4.5m .....	\$1,172.16
1	45-05998-05	Cable Power, 4 POS DTP to 2 POS DTP 5'/1.5m .....	175.17
<b>Total .....</b>			<b>\$1,347.33</b>

### STEP 4: CHOOSE BATTERY POWER CABLES TO POWER DISTRIBUTION MODULE

QTY	PART NO.	DESCRIPTION	U.S. DOLLARS
1	401-0016	Cable Power, 1 Lead, 2'/0.6m .....	\$ 84.80
1	DPX-0910	Cable, Power Extension, DynaJet, 30'/9m .....	519.60
1	45-05943	Cable Battery, 6GA/13.3mm to 2 POS DT, 60 amp Fuse .....	165.53
<b>Total .....</b>			<b>\$ 769.93</b>

### STEP 5: CHOOSE NOZZLE HARNESS

QTY	PART NO.	DESCRIPTION	U.S. DOLLARS
4	45-04005-06-20	Harness, Nozzle, DynaJet, AMPSS 1.5, 20"/50cm, 6 Nozzle.....	\$2,168.60
1	45-04005-06-20-START	Harness, Nozzle, DynaJet, AMPSS 1.5, 20"/50cm, 6 Nozzle, W/ START Term.....	570.83
1	45-04005-06-20-END	Harness, Nozzle, DynaJet, AMPSS 1.5, 20"/50cm, 6 Nozzle, W/ END Term.....	570.83
3	45-04005-08-20	Harness, Nozzle, DynaJet, AMPSS 1.5, 20"/50cm, 8 Nozzle.....	1,858.80
<b>Total .....</b>			<b>\$ 5,169.06</b>

### STEP 6: CHOOSE NOZZLE SOLENOIDS

QTY	PART NO.	DESCRIPTION	U.S. DOLLARS
60	115880-2-12*	115880-2-12 e-Chemsaver®.....	\$16,044.00
<b>Total .....</b>			<b>\$16,044.00</b>

\*Please order separately with TeeJet Fluid Delivery items

### STEP 7: CHOOSE SENSOR CAN EXTENSION CABLES

QTY	PART NO.	DESCRIPTION	U.S. DOLLARS
2	45-04006-13	Sensor CAN Extension 13'/ 4m.....	\$263.20
2	45-04006-20	Sensor CAN Extension 20'/ 6m.....	290.36
<b>Total .....</b>			<b>\$ 553.56</b>

# DYNAJET® IC7140 HYBRID NOZZLE CONTROL SYSTEM

## STEP 8: CHOOSE POWER EXTENSION CABLES

QTY	PART NO.	DESCRIPTION	U.S. DOLLARS
1	45-05161	Cable, Power Extension 20', 2 POS WP .....	\$ 137.57
2	45-05971-10	Cable Power, 4 POS DTP, 10GA, 10'/ 3m .....	331.04
2	45-05971-20	Cable Power, 4 POS DTP, 10GA, 20'/ 6m .....	491.20
	<b>Total</b> .....		<b>\$ 959.81</b>

## STEP 9: CHOOSE OPTIONAL NOZZLE EXTENSION CABLES

QTY	PART NO.	DESCRIPTION	U.S. DOLLARS
3	45-04001-40	Cable, Extension, 40"/ 1m, 2 POS, AMPSS1.5.....	\$ 189.36
	<b>Total</b> .....		<b>\$ 189.36</b>
	<b>Grand Total for Complete DynaJet IC7140 Hybrid</b> .....		<b>\$ 44,044.89</b>

DYNAJET NOZZLE CONTROL



# DYNAJET® IC7140 DUAL DRIVER NOZZLE CONTROL SYSTEM

DynaJet IC7140 ISOBUS is an ISOBUS solution for OEM sprayers.

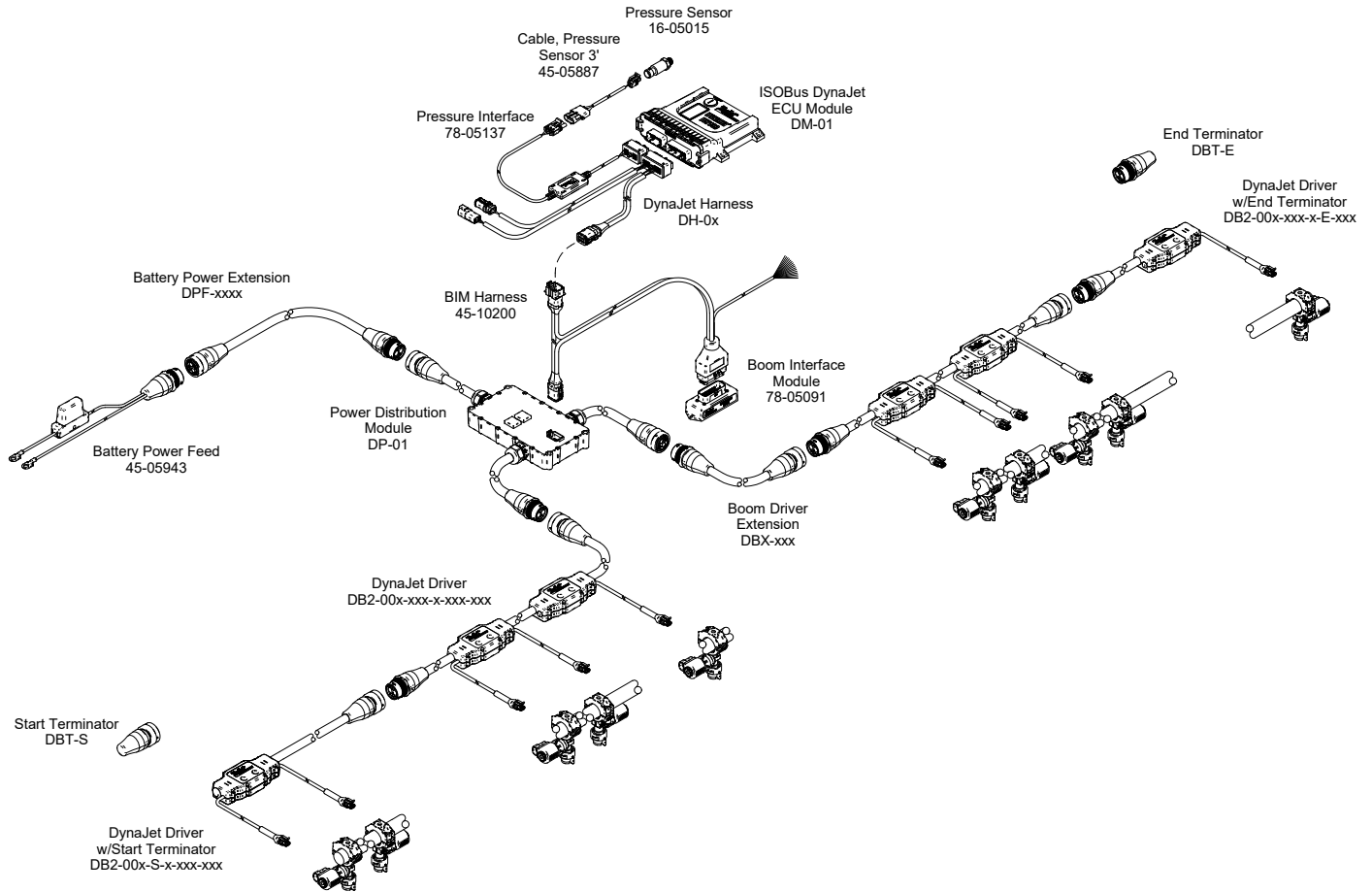

DYNAJET NOZZLE CONTROL

Note: Please contact TeeJet for pricing on DynaJet IC7140 ISOBUS Nozzle Control System

# DYNAJET® IC7140 DUAL DRIVER NOZZLE CONTROL SYSTEM

DYNAJET NOZZLE CONTROL

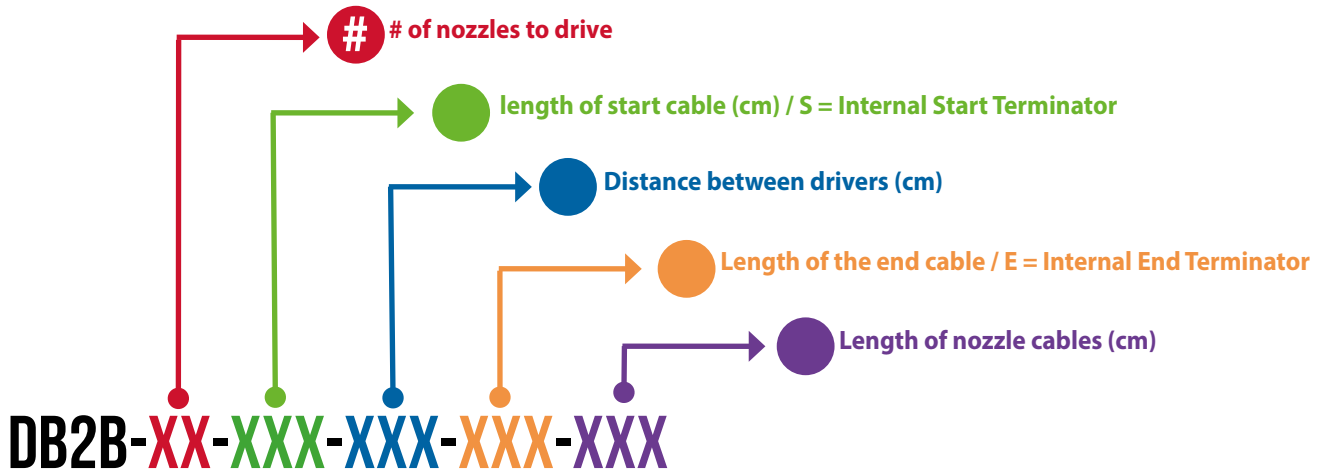
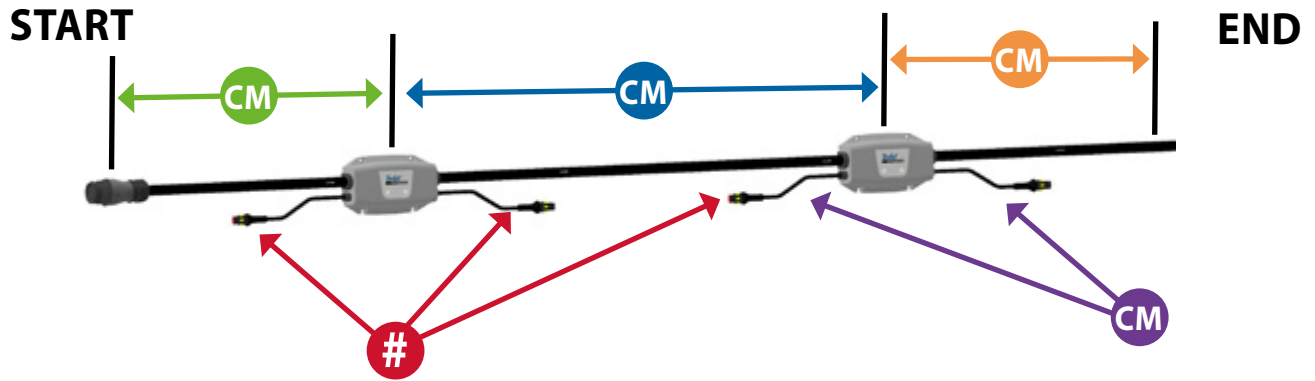

# DYNAJET® IC7140 DUAL DRIVER NOZZLE CONTROL SYSTEM

PART NO.

## DUAL DRIVER CABLE DB2B AVAILABILITY

### TWO NOZZLE CABLE

	#	CM	CM	CM	CM
DB2B-02-125-000-125-045	02	125	000	125	045
DB2B-02-170-000-050-040	02	170	000	050	040
DB2B-02-150-000-285-045	02	150	000	285	045
DB2B-02-100-000-285-045	02	100	000	285	045

### THREE NOZZLE CABLE

DB2B-03-170-050-050-040	03	170	050	050	040
DB2B-03-S-050-200-050	03	S	050	200	050
DB2B-03-S-050-250-050	03	S	050	250	050
DB2B-03-030-050-E-050	03	030	050	E	050
DB2B-03-S-050-070-050	03	S	050	070	050

### FOUR NOZZLE CABLE

DB2B-04-035-050-180-040	04	035	050	180	040
DB2B-04-050-100-050-035	04	050	100	050	035
DB2B-04-150-100-E-050	04	150	100	E	050
DB2B-04-180-050-035-040	04	180	050	035	040
DB2B-04-S-100-150-050	04	S	100	150	050
DB2B-04-130-100-130-050	04	130	100	130	050
DB2B-04-S-100-025-050	04	S	100	025	050
DB2B-04-150-100-E-050	04	150	100	E	050

### FIVE NOZZLE CABLE

DB2B-05-050-100-050-040	05	050	100	050	040
DB2B-05-100-100-E-045	05	100	100	E	045
DB2B-05-125-100-E-045	05	125	100	E	045
DB2B-05-S-100-025-045	05	S	100	025	045
DB2B-05-S-100-100-045	05	S	100	100	045
DB2B-05-S-100-125-045	05	S	100	125	045

### SIX NOZZLE CABLE

DB2B-06-030-050-120-050	06	030	050	120	050
DB2B-06-100-100-E-050	06	100	100	E	050
DB2B-06-120-050-030-050	06	120	050	030	050
DB2B-06-250-100-E-050	06	250	100	E	050
DB2B-06-100-100-E-050	06	100	100	E	050
DB2B-06-S-100-150-050	06	S	100	150	050

DYNAJET NOZZLE CONTROL



**ECOSTOP  
NOZZLE CONTROL**

# ECOSTOP NOZZLE CONTROL SYSTEM

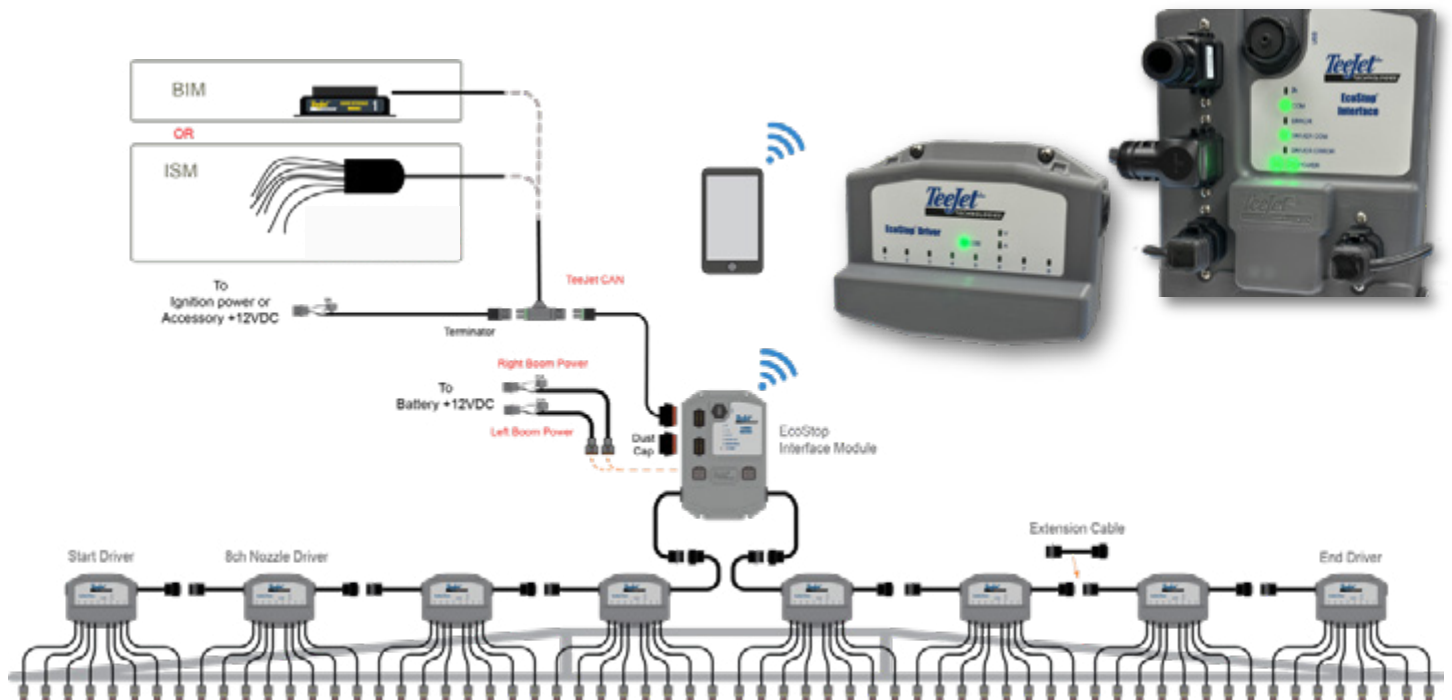

ECOSTOP NOZZLE CONTROL

## FEATURES AND BENEFITS OF ECOSTOP NOZZLE CONTROL

### HIGH RESOLUTION SECTION CONTROL

- Minimal overlap = chemical & financial savings
- Chemical reduction also has environmental benefits
- Minimize crop or turf damage

### ON/OFF AT THE NOZZLE:

- Instant spray on/off
- Boom circulation and rinse options



### 116950 ECOSTOP VALVE

- Designed for ON/OFF applications (not PWM)
- Low power consumption – 5.6 watts @ 12 VDC (~2.75 watts with EcoStop driver)
- Tool-free assembly and service
- Single version for all TeeJet nozzle body configurations and also available to fit competitive nozzle bodies
- Pressure rating 100 PSI / 7 bar @ 12VDC
- Good flow capacity - .7 GPM @ 5 PSI / 2.65 l/min @ .34 bar pressure drop



# ECOSTOP NOZZLE CONTROL SYSTEM

ECOSTOP WITH IC45 SYSTEM DIAGRAM

ECOSTOP NOZZLE CONTROL

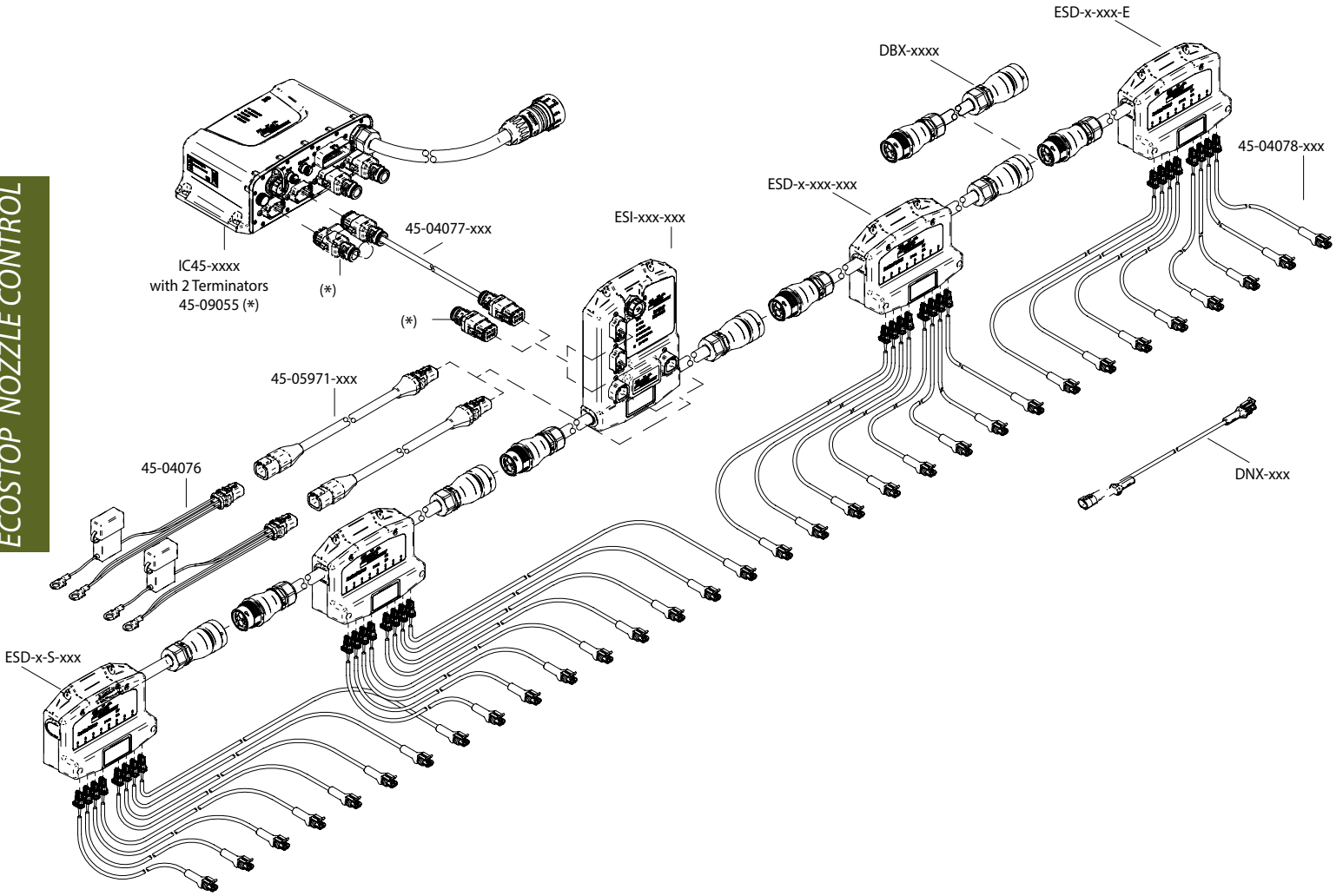



# ECOSTOP NOZZLE CONTROL SYSTEM

## ECOSTOP WITH ISM/BIM SYSTEM DIAGRAM

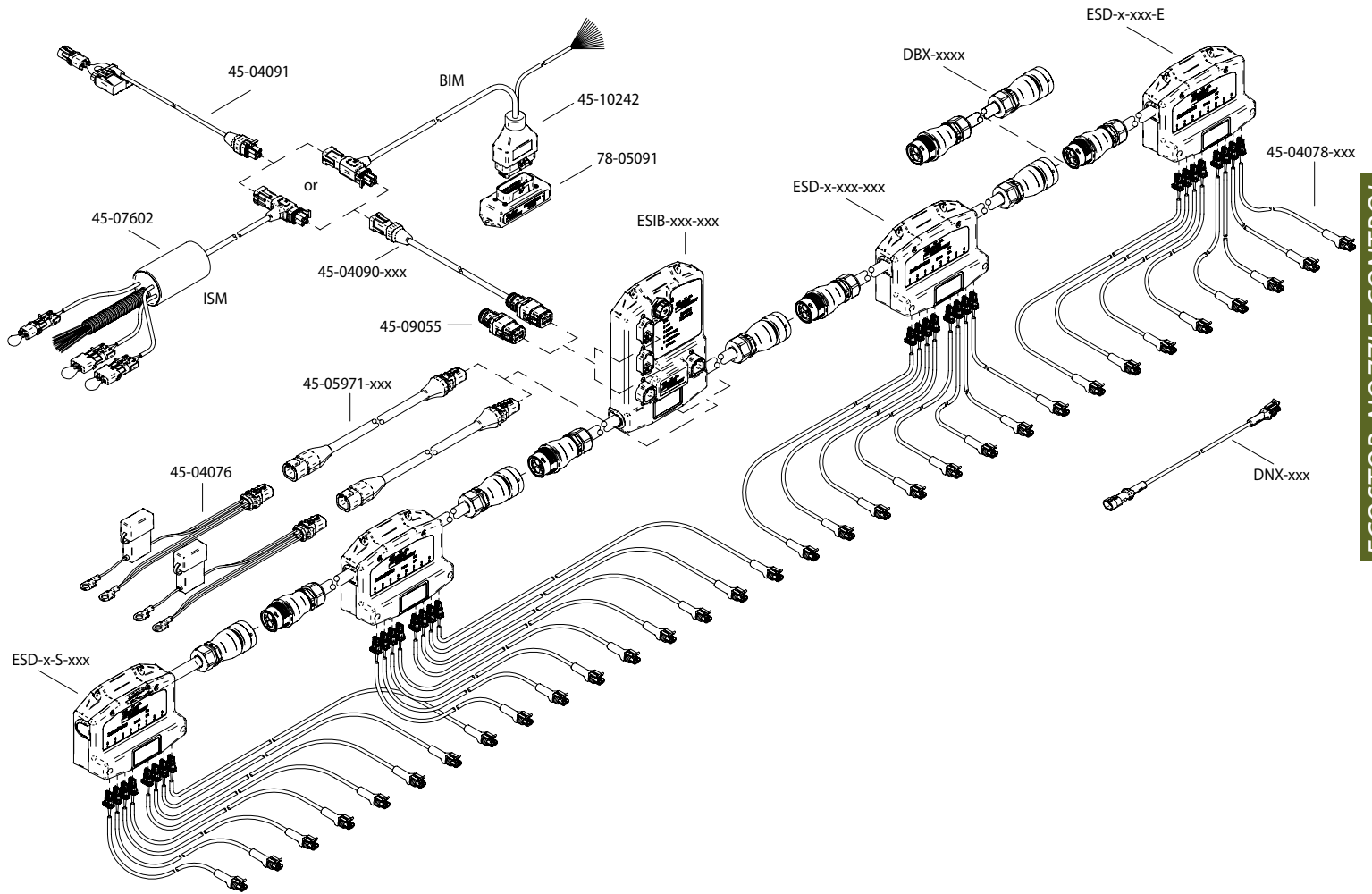

ECOSTOP NOZZLE CONTROL

# ECOSTOP NOZZLE CONTROL SYSTEM



EcoStop  
ESI-100-100



EcoStop BIM  
78-05091

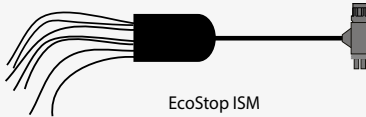

EcoStop ISM  
45-04090-xxx



EcoStop Driver  
ESD-xxx-



Solenoid Cable  
45-04078

## ECU

PART NO.	DESCRIPTION	U.S. DOLLARS
ESI-100-100	EcoStop Interface, IC45.....	\$ 1,484.18
ESIB-100-100	EcoStop Interface.....	1,484.18

## PLP CONNECTIONS TO IC45

PART NO.	DESCRIPTION	U.S. DOLLARS
45-04077-300	EcoStop Int. to IC45 PLP, 3m.....	\$ 159.87
45-04077-200	EcoStop Int. to IC45 PLP, 2m.....	149.74
45-04077-100	EcoStop Int. to IC45 PLP, 1m.....	139.61
45-04090-300	EcoStop Int. to BIM/ISM, 3m.....	145.89
45-04090-200	EcoStop Int. to BIM/ISM, 2m.....	135.12
45-04090-100	EcoStop Int. to BIM/ISM, 1m.....	124.39

## DRIVERS

ESD-8-220-220	EcoStop Driver, 8 output.....	\$ 881.51
ESD-8-100-E	EcoStop Driver, 8 output w/End Term.....	881.51
ESD-8-5-100	EcoStop Driver, 8 output w/Start Term.....	881.51
ESD-7-300-200	EcoStop Driver, 7 output.....	881.51
ESD-7-275-200	EcoStop Driver, 7 output.....	881.51
ESD-7-210-400	EcoStop Driver, 7 output.....	881.51
ESD-7-050-275	EcoStop Driver, 7 output.....	881.51
ESD-6-100-340	EcoStop Driver, 6 output.....	881.51
ESD-6-340-100	EcoStop Driver, 6 output.....	881.51
ESD-6-100-E	EcoStop Driver, 6 output w/End Term.....	881.51
ESD-6-100-340	EcoStop Driver, 6 output.....	881.51
ESD-5-300-200	EcoStop Driver, 5 output.....	881.51
ESD-4-300-200	EcoStop Driver, 4 output.....	881.51
ESD-3-300-200	EcoStop Driver, 3 output.....	881.51
ESD-2-300-200	EcoStop Driver, 2 output.....	881.51
ESD-1-300-200	EcoStop Driver, 1 output.....	881.51

## SOLENOID CABLES

45-04078-300	EcoStop Solenoid Cables 300 cm.....	\$ 43.70
45-04078-250	EcoStop Solenoid Cables 250 cm.....	43.70
45-04078-220	EcoStop Solenoid Cables 220 cm.....	43.70
45-04078-200	EcoStop Solenoid Cables 200 cm.....	43.70
45-04078-170	EcoStop Solenoid Cables 170 cm.....	43.70
45-04078-120	EcoStop Solenoid Cables 120 cm.....	43.70
45-04078-070	EcoStop Solenoid Cables 70 cm.....	43.70

# ECOSTOP NOZZLE CONTROL SYSTEM



Power Extension  
45-04078



Driver Extension Cable  
DBX-xxxx

## POWER CABLES

PART NO.	DESCRIPTION	U.S. DOLLARS
45-04076	Battery Cable, EcoStop, 25AMP, 75cm. ....	\$ 122.57
45-04091	Cable, Pwr. EcoStop Interface To Switched +12v, 10'.	91.95
45-05971-50	Power Cable, 50'.....	477.68
45-05971-40	Power Cable, 40'.....	394.81
45-05971-30	Power Cable, 30'.....	327.40
45-05971-20	Power Cable, 20'.....	245.60
45-05971-10	Power Cable, 10'.....	165.51
45-05971-05	Power Cable, 5'.....	135.42

## NOZZLE SOLENOIDS

116950-12	EcoStop Solenoid.....	\$ 179.20
-----------	-----------------------	-----------

NOTE: The 116950-12 is ordered as a fluid delivery part from TeeJet Wheaton and different discount applies.

## DRIVER EXTENSION CABLES

DBX-0050	50 cm/1.6' Boom Extension Cable.....	\$ 351.82
DBX-0100	100 cm/3.3' Boom Extension Cable.....	361.14
DBX-0120	120 cm/3.9' Boom Extension Cable.....	363.99
DBX-0150	150 cm/4.9' Boom Extension Cable.....	370.54
DBX-0200	200 cm/6.6' Boom Extension Cable.....	378.67
DBX-0240	240 cm/7.9' Boom Extension Cable.....	386.70
DBX-0250	250 cm/8.2' Boom Extension Cable.....	391.65
DBX-0300	300 cm/9.8' Boom Extension Cable.....	404.55
DBX-0600	600 cm/19.7' Boom Extension Cable.....	481.79

## NOZZLE EXTENSION CABLES

DNX-050	50 cm/1.6' Nozzle Extension Cable.....	\$ 56.57
DNX-100	100 cm/3.3' Nozzle Extension Cable.....	58.66
DNX-150	150 cm/4.9' Nozzle Extension Cable.....	60.20
DNX-200	200 cm/6.6' Nozzle Extension Cable.....	62.75
DNX-300	300 cm/9.8' Nozzle Extension Cable.....	65.61

# ECOSTOP NOZZLE CONTROL SYSTEM

ECOSTOP NOZZLE CONTROL

PART NO.	DESCRIPTION	U.S. DOLLARS	NOTE
<b>HOW TO ORDER:</b>			
<b>STEP 1: CHOOSE ISOBUS RATE CONTROL ECU OR BIM/ISM:</b>			
IC45-0050	Module, IC45 Sprayer 1.6'/0.5m ISOBUS Cable.....	\$ 3,124.14	
IC45-0400	Module, IC45 Sprayer 13'/4m ISOBUS Cable.....	3,263.06	
78-05091	Module, Boom Interface.....	469.94	
45-07602	Module, Input Status.....	685.84	
<b>STEP 2: CHOOSE IC45 REG VALVE/SENSOR CABLE OR BIM HARNESS</b>			
45-09053-05	Cable, IC45 Sprayer, 5'/1.5 m DT/M'n'L/MP150, SPD 1.6'/.5 m.....	\$ 300.47	
45-09053-10	Cable, IC45 Sprayer, 10'/3 m DT/M'n'L/MP150, SPD 1.6'/.5 m.....	317.54	
45-09053-20	Cable, IC45 Sprayer, 20'/6 m DT/M'n'L/MP150, SPD 1.6'/.5 m.....	351.66	
45-09054-05	Cable, IC45 Sprayer, 5'/1.5m, WP/MP150/AMP, Speed 1.6'/0.5m.....	300.47	
45-09054-10	Cable, IC45 Sprayer, 10'/3m, WP/MP150/AMP, Speed 1.6'/0.5m.....	317.54	
45-09054-20	Cable, IC45 Sprayer, 20'/6m, WP/MP150/AMP, Speed 1.6'/0.5m.....	351.66	
45-10142	Harness, Boom Interface Module.....	398.97	
45-04091	Cable, Pwr. EcoStop Interface To Switched +12v, 10'.....	91.95	1
<b>STEP 3: CHOOSE ECOSTOP ECU</b>			
ESI-100-100	EcoStop Interface, IC45.....	\$ 1,484.18	
ESIB-100-100	EcoStop Interface.....	1,484.18	
<b>STEP 4: CHOOSE PLP CONNECTIONS TO IC45 OR BIM/ISM</b>			
45-04077-300	EcoStop Int. to IC45 PLP, 3m.....	\$ 159.87	
45-04077-200	EcoStop Int. to IC45 PLP, 2m.....	149.74	
45-04077-100	EcoStop Int. to IC45 PLP, 1m.....	139.61	
45-04090-300	EcoStop Int. to BIM/ISM, 3m.....	145.89	
45-04090-200	EcoStop Int. to BIM/ISM, 2m.....	135.12	
45-04090-100	EcoStop Int. to BIM/ISM, 1m.....	124.39	
<b>STEP 5: CHOOSE DRIVERS</b>			
ESD-8-220-220	EcoStop Driver, 8 output.....	\$ 881.51	
ESD-8-100-E	EcoStop Driver, 8 output w/End Term.....	881.51	
ESD-8-5-100	EcoStop Driver, 8 output w/Start Term.....	881.51	
ESD-7-300-200	EcoStop Driver, 7 output.....	881.51	
ESD-7-275-200	EcoStop Driver, 7 output.....	881.51	
ESD-7-210-400	EcoStop Driver, 7 output.....	881.51	
ESD-7-050-275	EcoStop Driver, 7 output.....	881.51	
ESD-6-100-340	EcoStop Driver, 6 output.....	881.51	
ESD-6-340-100	EcoStop Driver, 6 output.....	881.51	
ESD-6-100-E	EcoStop Driver, 6 output w/End Term.....	881.51	
ESD-6-100-340	EcoStop Driver, 6 output.....	881.51	
ESD-5-300-200	EcoStop Driver, 5 output.....	881.51	
ESD-4-300-200	EcoStop Driver, 4 output.....	881.51	
ESD-3-300-200	EcoStop Driver, 3 output.....	881.51	
ESD-2-300-200	EcoStop Driver, 2 output.....	881.51	
ESD-1-300-200	EcoStop Driver, 1 output.....	881.51	
<b>STEP 6: CHOOSE SOLENOID CABLES</b>			
45-04078-300	EcoStop Solenoid Cables 300 cm.....	\$ 43.70	
45-04078-250	EcoStop Solenoid Cables 250 cm.....	43.70	
45-04078-220	EcoStop Solenoid Cables 220 cm.....	43.70	
45-04078-200	EcoStop Solenoid Cables 200 cm.....	43.70	
45-04078-170	EcoStop Solenoid Cables 170 cm.....	43.70	
45-04078-120	EcoStop Solenoid Cables 120 cm.....	43.70	
45-04078-070	EcoStop Solenoid Cables 70 cm.....	43.70	

# ECOSTOP NOZZLE CONTROL SYSTEM

PART NO.	DESCRIPTION	U.S. DOLLARS	NOTE
<b>STEP 7: CHOOSE POWER CABLES</b>			
45-04076	Battery Cable, EcoStop, 25AMP, 75cm .....	\$ 122.57	
45-05971-50	Power Cable, 50' .....	477.68	
45-05971-40	Power Cable, 40' .....	394.81	
45-05971-30	Power Cable, 30' .....	327.40	
45-05971-20	Power Cable, 20' .....	245.60	
45-05971-10	Power Cable, 10' .....	165.51	
45-05971-05	Power Cable, 5' .....	135.42	
<b>STEP 8: CHOOSE NOZZLE SOLENOIDS</b>			
116950-12	EcoStop Solenoid	\$ 179.20	2
<b>STEP 9: CHOOSE DRIVER EXTENSION CABLES</b>			
DBX-0050	50 cm/1.6' Boom Extension Cable .....	\$ 351.82	
DBX-0100	100 cm/3.3' Boom Extension Cable .....	361.14	
DBX-0120	120 cm/3.9' Boom Extension Cable .....	363.99	
DBX-0150	150 cm/4.9' Boom Extension Cable .....	370.54	
DBX-0200	200 cm/6.6' Boom Extension Cable .....	378.67	
DBX-0240	240 cm/7.9' Boom Extension Cable .....	386.70	
DBX-0250	250 cm/8.2' Boom Extension Cable .....	391.65	
DBX-0300	300 cm/9.8' Boom Extension Cable .....	404.55	
DBX-0600	600 cm/19.7' Boom Extension Cable .....	481.79	
<b>STEP 10: CHOOSE PLP CONNECTIONS TO IC45 OR BIM/ISM</b>			
DNX-050	50 cm/1.6' Nozzle Extension Cable .....	56.57	
DNX-100	100 cm/3.3' Nozzle Extension Cable .....	58.66	
DNX-150	150 cm/4.9' Nozzle Extension Cable .....	60.20	
DNX-200	200 cm/6.6' Nozzle Extension Cable .....	62.75	
DNX-300	300 cm/9.8' Nozzle Extension Cable .....	65.61	

**Notes:**

1 Extension cables are available for extra length. There is a 6' extension (45-08106), a 12' extension (45-08112), a 20' extension (45-08117) and a 30' extension (45-08118).

2 The 116950-12 is ordered as a fluid delivery part from TeeJet Wheaton and different discount applies. If the machine has more than 80 solenoids then contact TeeJet for additional power distribution modules..

ECOSTOP NOZZLE CONTROL

# ECOSTOP NOZZLE CONTROL SYSTEM

## IC45 ORDER EXAMPLES

ECOSTOP NOZZLE CONTROL

SYSTEM 1:	IC45	24 NOZZLES (24 ROW 30"/76 CM SPACING PLANTER)	U.S. DOLLARS
QTY	PART NO.	DESCRIPTION	
1	IC45-0400	Module, IC45 Sprayer 13'/4m ISOBUS Cable .....	\$ 3,263.06
1	45-09053-20	Cable, IC45 Sprayer, 20'/6 m DT/M'n'L/MP150, Spd 1.6'/.5 m .....	351.66
1	ESI-100-100	EcoStop Interface, IC45 .....	1,484.18
1	45-04077-300	EcoStop Int. to IC45 PLP, 3m. ....	159.87
1	ESD-8-220-220	EcoStop Driver, 8 output. ....	881.51
1	ESD-8-100-E	EcoStop Driver, 8 output w/End Term. ....	881.51
1	ESD-8-5-100	EcoStop Driver, 8 output w/Start Term.....	881.51
6	45-04078-300	EcoStop Solenoid Cables 300 cm .....	262.20
6	45-04078-220	EcoStop Solenoid Cables 220 cm .....	262.20
6	45-04078-200	EcoStop Solenoid Cables 200 cm .....	262.20
6	45-04078-170	EcoStop Solenoid Cables 170 cm .....	262.20
24	116950-12	EcoStop Solenoid .....	4,300.80 1
2	45-05971-30	Power Cable, 30' .....	654.80
2	45-04076	Battery Cable, EcoStop, 25AMP, 75cm. ....	245.14
2	DBX-0250	250 cm/8.2' Boom Extension Cable .....	783.30
2	DBX-0600	600 cm/19.7' Boom Extension Cable .....	963.58
12	DNX-100	100 cm/3.3' Nozzle Extension Cable .....	703.92
<b>TOTAL IC45 SYSTEM .....</b>			<b>\$ 3,614.72</b>
<b>TOTAL ECOSTOP SYSTEM .....</b>			<b>\$ 12,988.92</b>
SYSTEM 2:	IC45	36 NOZZLES (20"/50 CM SPACING)	
QTY			
1	IC45-0400	Module, IC45 Sprayer 13'/4m ISOBUS Cable .....	\$ 3,263.06
1	45-09053-20	Cable, IC45 Sprayer, 20'/6 m DT/M'n'L/MP150, Spd 1.6'/.5 m .....	351.66
1	ESI-100-100	EcoStop Interface, IC45 .....	1,484.18
1	45-04077-200	EcoStop Int. to IC45 PLP, 2m. ....	149.74
1	ESD-8-100-E	EcoStop Driver, 8 output w/End Term. ....	881.51
1	ESD-8-5-100	EcoStop Driver, 8 output w/Start Term.....	881.51
1	ESD-7-300-200	EcoStop Driver, 7 output. ....	881.51
1	ESD-7-210-400	EcoStop Driver, 7 output. ....	881.51
1	ESD-6-100-100	EcoStop Driver, 6 output .....	881.51
2	45-04078-250	EcoStop Solenoid Cables 250 cm .....	87.40
6	45-04078-220	EcoStop Solenoid Cables 220 cm .....	262.20
8	45-04078-170	EcoStop Solenoid Cables 170 cm .....	349.60
10	45-04078-120	EcoStop Solenoid Cables 120 cm .....	437.00
10	45-04078-70	EcoStop Solenoid Cables 70 cm .....	437.00
36	116950-12	EcoStop Solenoid .....	6,451.20 1
2	45-05971-30	Power Cable, 30' .....	654.80
2	45-04076	Battery Cable, EcoStop, 25AMP, 75cm. ....	245.14
1	DBX-0050	50 cm/1.6' Boom Extension Cable .....	351.82
2	DBX-0150	150 cm/4.9' Boom Extension Cable .....	741.08
<b>TOTAL IC45 SYSTEM .....</b>			<b>\$ 3,614.72</b>
<b>TOTAL ECOSTOP SYSTEM .....</b>			<b>\$ 16,058.71</b>



# ECOSTOP NOZZLE CONTROL SYSTEM

SYSTEM 3: IC45		60 NOZZLES (20"/50 CM SPACING)		U.S. DOLLARS
QTY	PART NO.	DESCRIPTION		
1	IC45-0400	Module, IC45 Sprayer 13'/4m ISOBUS Cable		\$ 3,263.06
1	45-09053-20	Cable, IC45 Sprayer, 20'/6 m DT/M'n'L/MP150, Spd 1.6'/.5 m		351.66
1	ESI-100-100	EcoStop Interface, IC45		1,484.18
1	45-04077-100	EcoStop Int. to IC45 PLP, 1m.		139.61
2	ESD-8-220-220	EcoStop Driver, 8 output.		1,763.02
1	ESD-7-275-200	EcoStop Driver, 7 output.		881.51
1	ESD-7-050-275	EcoStop Driver, 7 output.		881.51
1	ESD-6-5-100	EcoStop Driver, 6 output w/Start Term.		881.51
1	ESD-6-5-050	EcoStop Driver, 6 output w/Start Term.		881.51
2	ESD-6-100-340	EcoStop Driver, 6 output.		1,763.02
1	ESD-6-340-100	EcoStop Driver, 6 output.		881.51
10	45-04078-220	EcoStop Solenoid Cables 220 cm		437.00
10	45-04078-170	EcoStop Solenoid Cables 170 cm		437.00
20	45-04078-120	EcoStop Solenoid Cables 120 cm		874.00
20	45-04078-70	EcoStop Solenoid Cables 70 cm		874.00
60	116950-12	EcoStop Solenoid		10,752.00 1
2	45-05971-30	Power Cable, 30'		654.80
2	45-04076	Battery Cable, EcoStop, 25AMP, 75cm.		245.14
2	DBX-0050	50 cm/1.6' Boom Extension Cable		703.64
4	DNX-100	100 cm/3.3' Nozzle Extension Cable		234.64
<b>TOTAL IC45 SYSTEM</b>				<b>\$ 3,614.72</b>
<b>TOTAL ECOSTOP SYSTEM</b>				<b>\$ 24,769.60</b>
SYSTEM 4: IC45		72 NOZZLES (20"/50 CM SPACING)		
QTY	PART NO.	DESCRIPTION		U.S. DOLLARS
1	IC45-0400	Module, IC45 Sprayer 13'/4m ISOBUS Cable		\$ 3,263.06
1	45-09053-20	Cable, IC45 Sprayer, 20'/6 m DT/M'n'L/MP150, Spd 1.6'/.5 m		351.66
1	ESI-100-100	EcoStop Interface, IC45		1,484.18
1	45-04077-200	EcoStop Int. to IC45 PLP, 2m.		149.74
6	ESD-8-220-220	EcoStop Driver, 8 output.		5,289.06
1	ESD-6-100-340	EcoStop Driver, 6 output.		881.51
1	ESD-6-340-100	EcoStop Driver, 6 output.		881.51
1	ESD-6-5-050	EcoStop Driver, 6 output w/Start Term.		881.51
1	ESD-6-100-E	EcoStop Driver, 6 output w/End Term.		881.51
6	45-04078-300	EcoStop Solenoid Cables 300 cm		262.20
12	45-04078-220	EcoStop Solenoid Cables 220 cm		524.40
16	45-04078-170	EcoStop Solenoid Cables 170 cm		699.20
16	45-04078-120	EcoStop Solenoid Cables 120 cm		699.20
16	45-04078-70	EcoStop Solenoid Cables 70 cm		699.20
72	116950-12	EcoStop Solenoid		12,902.40 1
2	45-05971-30	Power Cable, 30'		654.80
2	45-04076	Battery Cable, EcoStop, 25AMP, 75cm.		245.14
2	DBX-0150	150 cm/4.9' Boom Extension Cable		722.28
2	DBX-0300	300 cm/9.8' Boom Extension Cable		809.10
4	DNX-100	100 cm/3.3' Nozzle Extension Cable		234.64
6	DNX-200	200 cm/6.6' Nozzle Extension Cable		376.50
<b>TOTAL IC45 SYSTEM</b>				<b>\$ 3,614.72</b>
<b>TOTAL ECOSTOP SYSTEM</b>				<b>\$ 29,278.08</b>

ECOSTOP NOZZLE CONTROL

Note: 1 The 116950-12 is ordered as a fluid delivery part from TeeJet Wheaton and different discount applies. If the machine has more than 80 solenoids then contact TeeJet for additional power distribution modules.

# ECOSTOP NOZZLE CONTROL SYSTEM

## ISM & BIM ORDER EXAMPLES

ECOSTOP NOZZLE CONTROL

SYSTEM 1: BIM		24 NOZZLES (24 ROW 30"/76 CM SPACING PLANTER)		U.S. DOLLARS
QTY	PART NO.	DESCRIPTION		
1	78-05091	Module, Boom Interface .....		\$ 469.94
1	45-10142	Harness, Boom Interface Module .....		398.97
1	45-04091	Cable, Pwr. EcoStop Interface To Switched +12v, 10' .....		91.95 1
1	ESIB-100-100	EcoStop Interface .....		1,484.18
1	45-04090-300	EcoStop Int. to BIM/ISM, 3m .....		145.89
1	ESD-8-220-220	EcoStop Driver, 8 output .....		881.51
1	ESD-8-100-E	EcoStop Driver, 8 output w/End Term. ....		881.51
1	ESD-8-S-100	EcoStop Driver, 8 output w/Start Term.....		881.51
6	45-04078-300	EcoStop Solenoid Cables 300 cm .....		262.20
6	45-04078-220	EcoStop Solenoid Cables 220 cm .....		262.20
6	45-04078-200	EcoStop Solenoid Cables 200 cm .....		262.20
6	45-04078-170	EcoStop Solenoid Cables 170 cm .....		262.20
24	116950-12	EcoStop Solenoid .....		4,300.80 2
2	45-05971-30	Power Cable, 30' .....		654.80
2	45-04076	Battery Cable, EcoStop, 25AMP, 75cm.....		245.14
2	DBX-0250	250 cm/8.2' Boom Extension Cable .....		783.30
2	DBX-0600	600 cm/19.7' Boom Extension Cable .....		963.58
12	DNX-100	100 cm/3.3' Nozzle Extension Cable .....		703.92
<b>TOTAL ECOSTOP SYSTEM .....</b>				<b>\$ 13,935.80</b>
SYSTEM 2: ISM		36 NOZZLES (20"/50 CM SPACING)		
QTY		DESCRIPTION		
1	45-07602	Module, Input Status .....		\$ 685.84
1	45-04091	Cable, Pwr. EcoStop Interface To Switched +12v, 10' .....		91.95 1
1	ESIB-100-100	EcoStop Interface .....		1,484.18
1	45-04090-300	EcoStop Int. to BIM/ISM, 3m .....		145.89
1	ESD-8-100-E	EcoStop Driver, 8 output w/End Term. ....		881.51
1	ESD-8-S-100	EcoStop Driver, 8 output w/Start Term.....		881.51
1	ESD-7-300-200	EcoStop Driver, 7 output .....		881.51
1	ESD-7-210-400	EcoStop Driver, 7 output .....		881.51
1	ESD-6-100-100	EcoStop Driver, 6 output .....		881.51
2	45-04078-250	EcoStop Solenoid Cables 250 cm .....		87.40
6	45-04078-220	EcoStop Solenoid Cables 220 cm .....		262.20
8	45-04078-170	EcoStop Solenoid Cables 170 cm .....		349.60
10	45-04078-120	EcoStop Solenoid Cables 120 cm .....		437.00
10	45-04078-70	EcoStop Solenoid Cables 70 cm .....		437.00
36	116950-12	EcoStop Solenoid .....		6,451.20 2
2	45-05971-30	Power Cable, 30' .....		654.80
2	45-04076	Battery Cable, EcoStop, 25AMP, 75cm.....		245.14
1	DBX-0050	50 cm/1.6' Boom Extension Cable .....		351.82
2	DBX-0150	150 cm/4.9' Boom Extension Cable .....		741.08
<b>TOTAL ECOSTOP SYSTEM .....</b>				<b>\$ 16,832.65</b>

# ECOSTOP NOZZLE CONTROL SYSTEM

SYSTEM 3: BIM		60 NOZZLES (20"/50 CM SPACING)		U.S. DOLLARS
QTY	PART NO.	DESCRIPTION		
1	78-05091	Module, Boom Interface .....		\$ 469.94
1	45-10142	Harness, Boom Interface Module .....		398.97
1	45-04091	Cable, Pwr. EcoStop Interface To Switched +12v, 10' .....		91.95 1
1	ESIB-100-100	EcoStop Interface .....		1,484.18
1	45-04090-100	EcoStop Int. to BIM/ISM, 1m .....		124.39
2	ESD-8-220-220	EcoStop Driver, 8 output .....		1,763.02
1	ESD-7-275-200	EcoStop Driver, 7 output .....		881.51
1	ESD-7-050-275	EcoStop Driver, 7 output .....		881.51
1	ESD-6-5-100	EcoStop Driver, 6 output w/Start Term.....		881.51
1	ESD-6-5-050	EcoStop Driver, 6 output w/Start Term.....		881.51
2	ESD-6-100-340	EcoStop Driver, 6 output .....		1,763.02
1	ESD-6-340-100	EcoStop Driver, 6 output .....		881.51
10	45-04078-220	EcoStop Solenoid Cables 220 cm .....		437.00
10	45-04078-170	EcoStop Solenoid Cables 170 cm .....		437.00
20	45-04078-120	EcoStop Solenoid Cables 120 cm .....		874.00
20	45-04078-70	EcoStop Solenoid Cables 70 cm .....		874.00
60	116950-12	EcoStop Solenoid .....		10,752.00 2
2	45-05971-30	Power Cable, 30' .....		654.80
2	45-04076	Battery Cable, EcoStop, 25AMP, 75cm .....		245.14
2	DBX-0050	50 cm/1.6' Boom Extension Cable .....		703.64
4	DNX-100	100 cm/3.3' Nozzle Extension Cable .....		234.64
<b>TOTAL ECOSTOP SYSTEM .....</b>				<b>\$ 25,715.24</b>
SYSTEM 4: BIM		60 NOZZLES (20"/50 CM SPACING)		
QTY	PART NO.	DESCRIPTION		
1	45-07602	Module, Input Status .....		\$ 685.84
1	45-04091	Cable, Pwr. EcoStop Interface To Switched +12v, 10' .....		91.95 1
1	ESIB-100-100	EcoStop Interface .....		1,484.18
1	45-04090-100	EcoStop Int. to BIM/ISM, 1m .....		124.39
6	ESD-8-220-220	EcoStop Driver, 8 output .....		5,289.06
1	ESD-6-100-340	EcoStop Driver, 6 output .....		881.51
1	ESD-6-340-100	EcoStop Driver, 6 output .....		881.51
1	ESD-6-5-050	EcoStop Driver, 6 output w/Start Term.....		881.51
1	ESD-6-100-E	EcoStop Driver, 6 output w/End Term.....		881.51
6	45-04078-300	EcoStop Solenoid Cables 300 cm .....		262.20
12	45-04078-220	EcoStop Solenoid Cables 220 cm .....		524.40
16	45-04078-170	EcoStop Solenoid Cables 170 cm .....		699.20
16	45-04078-120	EcoStop Solenoid Cables 120 cm .....		699.20
16	45-04078-70	EcoStop Solenoid Cables 70 cm .....		699.20
72	116950-12	EcoStop Solenoid .....		12,902.40 2
2	45-05971-30	Power Cable, 30' .....		654.80
2	45-04076	Battery Cable, EcoStop, 25AMP, 75cm .....		245.14
2	DBX-0150	150 cm/4.9' Boom Extension Cable .....		722.28
2	DBX-0300	300 cm/9.8' Boom Extension Cable .....		809.10
4	DNX-100	100 cm/3.3' Nozzle Extension Cable .....		234.64
6	DNX-200	200 cm/6.6' Nozzle Extension Cable .....		376.50
<b>TOTAL ECOSTOP SYSTEM .....</b>				<b>\$ 30,030.52</b>

Note: 1 The 116950-12 is ordered as a fluid delivery part from TeeJet Wheaton and different discount applies. If the machine has more than 80 solenoids then contact TeeJet for additional power distribution modules.

2 The 116950-12 is ordered as a fluid delivery part from TeeJet Wheaton and different discount applies. If the machine has more than 80 solenoids then contact TeeJet for additional power distribution modules.

ECOSTOP NOZZLE CONTROL



# COMPREHENSIVE LIST

SALES LITERATURE - GUIDANCE & SUBSCRIPTIONS  
- COMPREHENSIVE LIST

# SALES LITERATURE

PART NO.	DESCRIPTION	U.S. DOLLARS
98-01155	Brochure, 70 Series, Monitors And Controls .....	\$ 0.00
98-01187-ENUS-R9	Bulletin, Gps Speed, Sensor, US English .....	0.00
98-01359	Bulletin, RXA30 .....	0.00
98-01363	Bulletin, ISOBUS .....	0.00
98-01434	Bulletin, 744E Sprayer Controller W/430 Manifold .....	0.00
98-01448	Bulletin, Sentry 6120 .....	0.00
98-01449	Bulletin, Sentry 6140 .....	0.00
98-01451	Bulletin, Radion 8140. ....	0.00
98-01457	Bulletin, 801-802 Flowmeter. ....	0.00
98-01467-ENUS-R3	Guide, Radion Quick-Start US English .....	47.98
98-01493	Guide, Matrix 430 Quick-Start .....	17.39
98-01495	Bulletin, Matrix 430 Guidance .....	0.00
98-01497	Bulletin, Guidance System Selection Guide. ....	0.00
98-01515	Bulletin, UniPilot Pro .....	0.00
98-01516	Bulletin, FieldPilot Pro .....	0.00
98-01517	Bulletin, Sentry 6141 .....	0.00
98-01558	Bulletin, RX720 .....	0.00
LI-TJ368	Bulletin, 845 Sprayer Control .....	0.00
98-05010	Guide, User, Tasc 6000, 6300,& 6600 CE & Standard .....	38.70
98-05017	Guide, User, Arc 6000 CE & Standard .....	37.05
98-05018	Guide, User, Tasc 6100 CE & Standard .....	38.70
98-05305	Manual, Sentry 6120 Droplet Size Monitor .....	17.39
98-05306-ENUS-R3	Manual, Sentry 6140 TFM, US English .....	14.00
98-05332	Manual, Matrix 430. ....	29.18
98-05341-ENUS-R0	Manual, User, Fieldpilot Pro/ Unipilot Pro, US English .....	17.39
98-05342-ENUS	Manual, UniPilot Pro Install .....	27.43
98-05343-ENUS-R0	Manual, Sentry 6141 Isobus Tip Flow Monitor .....	17.39
98-05345	Manual, DynaJet 7140. ....	51.04
98-70025	Manual, Maint. Instruct. MI 744A. ....	25.26
98-70028	Guide, User 834-P .....	24.24
98-70030	Manual, User, 744E Sprayer Control .....	25.26

SALES LITERATURE

# COMPREHENSIVE LIST- GUIDANCE AND SUBSCRIPTIONS

PART NO.	DESCRIPTION	U.S. DOLLARS
90-10006 -ENUS-NH	KIT, M908 NAV-L1-GLO-ENUS, NO HRNS	\$ 3,093.40*
90-10006-ENUS	KIT, M908 NAV-L1-GLO-ENUS	3,258.95*
90-10007 -ENUS-NH	KIT, M908 NAV-L2+TSL-GLO-ENUS, NO HRNS	3,292.40*
90-10007-ENUS	KIT, M908 NAV-L2+TSL-GLO-ENUS	3,457.95*
90-10008-ENUS-NH	KIT, M908 NAV-L2+TSC-GLO-ENUS, NO HRNS	4,661.13* <b>NEW LOWER PRICE!</b>
90-10008-ENUS	KIT, M908 NAV-L2+TSC-GLO-ENUS	4,826.68* <b>NEW LOWER PRICE!</b>
90-10011-ENUS	KIT, M908 ISO-L1-GLO-ENUS	4,432.64*
90-10012-ENUS	KIT, M908 ISO-L2+TSL-GLO-ENUS	4,631.64*
90-10013-ENUS	KIT, M908 ISO-L2+TSC-GLO-ENUS	6,000.37* <b>NEW LOWER PRICE!</b>
99-01101	UNLOCK CODE, M908, ISOBUS	1,173.69*
99-01102	UPGRADE, M908 GNSS, BASE TO L1/L2, TSL	199.00*
99-01103	UPGRADE, M908 GNSS, BASE TO TSC-PRO READY	1,567.73* <b>NEW LOWER PRICE!</b>
99-01106	UPGRADE, M908 GNSS, TSL READY TO TSC-PRO READY	1,368.73* <b>NEW LOWER PRICE!</b>
GD430-GLO-P-B	KIT, MATRIX 430, GLONASS, PATCH, BAT	1,995.10*
GD430-GLO-P-C	KIT, MATRIX 430, GLONASS, PATCH, COBO	1,995.10*
GD430-GLO-P-L	KIT, MATRIX 430, GLONASS, PATCH, CIG	1,995.10*
GD430-GLO-R30-B	KIT, MATRIX 430, GLONASS, RXA30, BAT	2,510.03*
GD430-GLO-R30-C	KIT, MATRIX 430, GLONASS, RXA30, COBO	2,510.03*
GD430-GLO-R30-L	KIT, MATRIX 430, GLONASS, RXA30, CIG	2,510.03*
GD430VF-GLO-P-B	KIT, MATRIX 430VF, GLONASS, PATCH, BAT	1,995.10*
GD430VF-GLO-P-C	KIT, MATRIX 430VF, GLONASS, PATCH, COBO	1,995.10*
GD430VF-GLO-P-L	KIT, MATRIX 430VF, GLONASS, PATCH, CIG	1,995.10*
GD430VF-GLO-R30-B	KIT, MATRIX 430VF, GLONASS, RXA30, BAT	2,510.03*
GD430VF-GLO-R30-C	KIT, MATRIX 430VF, GLONASS, RXA30, COBO	2,510.03*
GD430VF-GLO-R30-L	KIT, MATRIX 430VF, GLONASS, RXA30, CIG	2,510.03*
99-01065	SUBSCRIPTION, TERRASTAR-C, 3 MONTHS	550.00**
99-01067	SUBSCRIPTION, TERRASTAR-C, 1 YEAR	950.00**
99-01068	SUBSCRIPTION, TERRASTAR-C, 2 YEARS	1,800.00**
99-01069	SUBSCRIPTION, TERRASTAR-C, 3 YEARS	2,650.00**
99-01075	SUBSCRIPTION, TERRASTAR-L 1 YEAR	350.00**
99-01076	SUBSCRIPTION, TERRASTAR-L 2 YEARS	665.00**
99-01077	SUBSCRIPTION, TERRASTAR-L 3 YEARS	980.00**
99-01087	SUBSCRIPTION, TERRASTAR-C PRO, 3 MONTHS	750.00**
99-01088	SUBSCRIPTION, TERRASTAR-C PRO, 1 YEAR	1,050.00**
99-01089	SUBSCRIPTION, TERRASTAR-C PRO, 2 YEARS	1,895.00**
99-01090	SUBSCRIPTION, TERRASTAR-C PRO, 3 YEARS	2,675.00**
99-01091	SUBSCRIPTION, RTK ASSIST 1 YEAR	350.00**
99-01092	SUBSCRIPTION, RTK ASSIST PRO	1,050.00**
99-01094	SUBSCRIPTION, TERRASTAR-X, 1 YEAR	1,050.00**
99-01096	SUBSCRIPTION, TERRASTAR-X, 5 YEAR	4,725.00**
99-01097	UNLOCK CODE, MATRIX 908, VRA, PRESCRIPTION APPLICATION	1,173.69

\*Different guidance multiplier is applied to these part numbers.

Contact TeeJet Sales Rep for more information.

\*\* No discounts apply

# COMPREHENSIVE LIST

PART NO.	DESCRIPTION	U.S. DOLLARS	PART NO.	DESCRIPTION	U.S. DOLLARS
114406	ELBOW, GAUGE, W/ 1/8" PTC CARTRIDGE	\$ 17.82	120-0043	SENSOR, INDUCTIVE, 8MM, GRA BIN MOTOR, 9"W/4 PIN AMP	369.89
116231	E-CHEMSAVER SERVICE WRENCH	10.58	120-0046	SENSOR, DJ ROTATION W/ MNT BRACKETS	574.48
006-0007	TUBE, PYTHON, 3/8 x 25 W/ FIT, 100/150, PC #145.0	62.40	120-0075	FLOWMETER, 3/4" MID-TECH, W/O SENSOR	908.40
006-0008	TUBE, PYTHON, 1/4 x 22 W/ FIT, 20, PC #32.0	48.17	120-0076	FLOWMETER, MID-TECH 3/4" W/1/2" H.T., W/O SENSOR	965.81
006-0009	TUBE, PYTHON, 3/8 x 25 200/350, SST/WG, PC #285.0	50.05	120-0078	FLOWMETER, 3/4" MID-TECH W/ 3/4" H.T., W/O SENSOR	965.81
006-0010	TUBE, PYTHON, 3/8 x 24 100/150, SST, PC #145.0	42.94	120-0080	REPAIR KIT, BALL BEARING, 3/4" F.M., W/O TURBINE	202.90
006-0011	TUBE, PYTHON, 1/2 x 25 200/350, SST/WG, PC #485.0	58.91	120-0081	HOSETAIL RETAINER NUT, 3/4" MID-TECH FLOWMETERS	16.33
006-0021	TUBE, PYTHON, 3/16 x 23, 50 SST/WG, PC #65.0	33.91	120-0082	HOSETAIL, 3/4" FOR 3/4" FLOWMETER	18.06
006-0022	TUBE, PYTHON, 1/4 x 23, 50 SST/WG, PC #110.0	37.54	120-0084	HOSETAIL, 1/2" FOR 3/4" FLOWMETER	16.33
006-0024	TUBE, PYTHON 3/16 x 22 W/ FIT., 12, WG, PC #18.0	73.16	120-0085	O-RING, HOSETAILS, 3/4" MID-TECH FLOWMETER	5.49
006-0101	LUBRICATING GREASE 1oz INJECTION PUMP TUBES	19.68	120-0100	FLOWMETER, 1" MID-TECH W/O SENSOR	937.12
006-2103	TUBE, PYTHON BULK, 3/16"	25.08	120-0101	FLOWMETER, 1" MID-TECH W/1-1/4" H.T., W/O SENSOR	991.03
006-2104	TUBE, PYTHON BULK, 1/4"	25.08	120-0102	FLOWMETER, 1" MID-TECH W/1" H.T., W/O SENSOR	991.03
006-2105	TUBE, PYTHON BULK, 3/8"	30.45	120-0110	REPAIR KIT, BALL BEARING, 1" F.M., W/O TURBINE	210.09
006-2106	TUBE, PYTHON BULK, 1/2"	33.91	120-0111	HOSETAIL RETAINER NUT, 1" MID-TECH FLOWMETERS	19.82
008-0007	TUBE, ED-PLEX, 3/8 x 25 W/FIT 100/150, WG, PC#145.0	51.77	120-0112	HOSETAIL, 1 1/4", FOR 1" FLOWMETER	18.06
008-0010	TUBE, ED-PLEX, 3/8 x 24 100/150, SST, PC #145.0	34.99	120-0113	HOSETAIL, 1" FOR 1" MID-TECH FLOWMETER	19.82
008-0132	TUBE LUBE, ED-PLEX 1 QT.	74.88	120-0114	O-RING, HOSETAIL, 1" MID-TECH FLOWMETER	18.06
008-2000	TUBE, VITON BULK 3/16"	44.68	120-0150	FLOWMETER, 1-1/2" MID-TECH W/O SENSOR	892.31
008-2002	TUBE, VITON BULK 1/4"	74.88	120-0151	FLOWMETER, 1-1/2" MID-TECH W/1-1/2" H.T., W/O SENSOR	892.31
008-2004	TUBE, VITON BULK 3/8"	140.87	120-0152	FLOWMETER, MID-TECH 1 1/2" W/1 1/4" H.T., W/O SENSOR	892.31
008-2103	TUBE, ED-PLEX BULK 3/16"	26.78	120-0160	REPAIR KIT, BALL BEARING, 1.5 & 2" F.M., W/O TURBINE	249.64
008-2104	TUBE, ED-PLEX BULK 1/4"	25.08	120-0161	HOSETAIL RETAINER NUT, 1-1/2" MID-TECH FLOWMETER	23.51
008-2105	TUBE, ED-PLEX BULK 3/8"	28.68	120-0162	HOSETAIL, 1-1/2" FOR 1-1/2" MID-TECH FLOWMETER	23.51
008-2106	TUBE, ED-PLEX BULK 1/2"	28.68	120-0163	HOSETAIL, 1-1/4" FOR 1-1/2" FLOWMETER	23.51
01-50007	CB, MODULE FOR 744A-3 37206-COMMAT	209.74	120-0164	O-RING, HOSETAILS, 1-1/2" MID-TECH FLOWMETER	18.06
01-50050	CBA, 744E-3 SWITCHBOX	285.12	120-0200	FLOWMETER, 2" MID-TECH W/O SENSOR	1,678.52
01-50051	CBA, 744E-5 SWITCHBOX	359.46	120-1002	TUNNEL, INLET 1" FM	45.04
030-0001	K-COUPLER, 1/2" x 5/8"	88.23	120-1003	TUNNEL, DISCHARGE 1" FM	71.98
030-0004	K-COUPLER, 1/2" x 1/2"	88.23	120-1009	TURBINE, 1" FM	308.98
08-50001	CP37222-COMMAT LED, BOOM, REPLACEMENT	15.90	120-1509	TURBINE, 1.5" FM	515.29
101-0001	BRUSH 206 MOTOR	60.55	120-7509	TURBINE, 3/4" FM	319.67
101-0002	BRUSH 212/M4000 MOTORS	48.12	121-0104	INSERT, 2.5-25 GPM, SAPPHIRE BEARINGS, 1" RAPID CHECK	612.27
102-0108	DECAL, TANK SCALE, 25 GAL	26.78	121-0106	REPAIR KIT, SAPPHIRE 2.5- 25 GPM INSERT 1" RAPID CH	305.29
102-0110	DECAL, CHEMICAL TANK ID	14.28	121-0120	FLOWMETER, 1" RAPID CHECK 2.5-25 GPM, 1" HOSETAIL	991.03
105-0002	CONSOLE, DUAL DRIVE AGITATION	297.46	121-0150	FLOWMETER BODY, 1.5" RAPD CHECK	506.38
105-0007	CONSOLE, CFM W/#8 RING TERM	1,708.52	121-0152	FLOWMETER, 1.5" RAPID CHECK, 9-90 GPM	1,351.74
105-0012	CONSOLE, VARIABLE SPEED SINGLE AGITATION	529.08	121-0153	INSERT, 2.5 - 16 GPM SAPPH. , 1.5" RAPID CHECK	944.30
105-0016	CONSOLE, DUAL VARIABLE SPEED AGITATION	1,054.29	121-0154	INSERT, 9-90GPM SAPPHIRE BEARINGS 1.5" RAPID CHECK	709.26
105-0028	DRIVER, GRANULAR BIN	1,734.71	121-0155	REPAIR KIT, SAPPHIRE, 2.5 - 16 GPM INSERT, 1.5" RAPID	296.38
106-0207	DECAL, TASC 6200 CONSOLE	17.69	121-0158	FLOWMETER, ASSY 1.5" RC HIGH PRESSURE W/ 1.5 HB	1,779.00
106-0620	END PANEL, SMALL EXTRU- SION BLANK	19.44	121-0171	FLOWMETER, RAPID CHECK 1.5" 9-90 GPM, 1.5" H.T.	1,448.71
116260-250	FLOWMETER ASSY., SENTRY PTC 6140, 1/4	112.31			
116260-312	FLOWMETER ASSY., SENTRY PTC 6140, 5/16	112.31			
116260-375	FLOWMETER ASSY., SENTRY PTC 6140, 3/8	112.31			
120-0001-KIT	RADAR, WITH STANDARD MOUNTING BRACKETS	2,379.34			
120-0004	FLOW SENSOR, N.O., 1.5 GPM	1,375.74			
120-0005	FLOW SENSOR, N.O., 5 GPM	820.25			
120-0009	SENSOR, APPLICATION RATE 360 SLOT, 10' CABLE	660.74			
120-0011	SENSOR, UNIVERSAL WHEEL	531.42			
120-0014	SENSOR, CFM 18MM CIRCUIT PROTECTED/L.E.D.	321.60			
120-0020	SENSOR FLOW ASSY, C.F.M. .3 - 2 G.P.M.	583.56			
120-0030	SENSOR FLOW ASSY, C.F.M. .05 - .5 G.P.M.	583.56			
120-0031	SENSOR, PRESSURE 0-300 PSI	1,595.93			
120-0037	FLOWMETER, SST, 1-1/4" W/SENSOR	2,148.81			
120-0040	SENSOR, INDUCTANCE, GRANULAR BIN DRIVER	344.86			
120-0041	SENSOR, RATE, INDUCTIVE, W/6 FT CABLE, 3 POS. PACK	305.29			
120-0042	SENSOR, INDUCTIVE 8MM SHAFT SENSOR PACKARD CONN	344.86			



# COMPREHENSIVE LIST

COMPREHENSIVE LIST

PART NO.	DESCRIPTION	U.S. DOLLARS
160-0001	TANK, 7.5gal .5" FITTING	509.45
16-00001	MAGNET, NORTH SELF ADHSV WHEEL SENSOR	14.59
160-0004	HEEL PLATE, SST 7.5gal TANKS	62.76
160-0005	MOUNTING BASE, SINGLE SST 7.5gal TANK	293.98
160-0006	COUPLING, FEMALE, 1/2" SST, W/FITTING	281.05
160-0007	COUPLING, NIPPLE, 1/2" SST FEMALE THREAD	130.09
160-0009	SUCTION TUBE, PP, 3/4" ID x 12.5" LONG	60.64
160-0010	BAFFLE, SST SUCTION	42.94
160-0013	LATCH, SST LOCKING	35.82
160-0015	MOUNTING BASE, SST, DUAL W/MOUNTING BRACKET	630.48
160-0016	LID, 5" NORWESCO	73.16
160-0019	GASKET, EPDM 5" NORWESCO LID	33.91
160-0021	TANK, 7.5gal .5" FITTING W/AGITATION	1,706.06
160-0022	TANK, 25gal .75" FITTING	1,262.63
16-00022	SENSOR CAMERA TEEJET 3.6mm LENS w/CXA	398.67
160-0024	LATCH PLATE, SST DUAL 25gal TANK	46.40
16-00024	SENSOR, PCB ASSY., 5v-12v OPERATION	245.30
160-0025	TANK, 25gal .75" FITTING W/ AGITATION	2,473.46
16-00027	SENSOR, PCB ASSY., 5v-12v OPERATION, w/RAVEN CONN.	245.30
160-0028	SUCTION TUBE, PP .75" ID x 23.5" LONG	69.53
16-00028	SENSOR, HALL EFFECT ASSY. TIP MONITOR FLOWMETER	75.23
16-00029	SENSOR, PCB ASSY., 5v-12v OPERATION, w/DT04-3P CONN.	245.30
160-0032	TANK, 7.5gal .75" FITTING	679.41
16-00032	SENSOR, PCB ASSY., 5v-12vOPER., w/ 3 POS WP SHROUD	245.30
160-0033	TANK, 25gal .5" FITTING	1,264.37
160-0034	TANK, 7.5 GAL.75" FITTING w/AGITATION	1,590.27
16-00034	SENSOR, 802FM, W/DTM04-3P, VARITECH PINOUT	245.30
160-0035	TANK, 25gal 1/2" FITTING WITH AGITATION	2,441.36
160-0036	LID, 5" DEN HARTOG W/GASKET	73.16
160-0039	GASKET, EPDM 5" DEN HARTOG LID	33.91
16-05000	SENSOR, HALL EFFECT	187.79
16-05004	KIT, RAWSON GEAR SENSOR	345.02
16-05007	SENSOR MAGNET, 1" SHAFT FOR 28-05004 MOTOR	251.41
16-05015	SENSOR, PRESSURE, 0-145 PSI/ 0-10 BAR	345.02
16-05016	SENSOR, PRESSURE, 0-363 PSI/ 0-25 BAR	352.80
16-05021	SENSOR, ROTARY ANGLE, CAN	1,267.35
16-05022	KIT, GENERIC WHEEL ANGLESENSOR W/ LINKAGE	1,406.50
16-40000	SENSOR, PRESSURE, 2.5 BAR 46104-2.5	472.26
16-40003	SENSOR, WHEEL 38412	210.09
16-40004	SENSOR, PROX. SPEED 38412-1	147.24
16-40007	SENSOR, WHEEL, ASBL 38525-1	532.03
16-40012	WHEEL SENSOR ASSY (855) 38525-COMMAT	684.48
16-40013	WHEEL, SENSOR BRKT ASSY 38531-IZP	117.64
16-40015	WHEEL SPEED 4 METER 45962-40	156.35
16-40019	SENSOR, PROXIMITY, w/MID-TECH RADAR CONN	188.55
16-50016	SWITCH, PRESSURE, 290-725 #4MORB, 2 POS AMPSEAL 1.5	135.54
16-50017	PRESSURE SENSOR, 3000 PSI	963.35
170-0001-KIT	AGITATION KIT,7.5 GAL TANK W/SILICONE & INSTR.	1,159.32
170-0004	BRACKET, SST PROPELLOR SUPPORT AGITATION KIT	66.05
170-0007	MOTOR DRIVE ASSY, AGITAT- ION KIT 7.5 & 25gal TANK	742.64
170-0008-KIT	AGITATION KIT, 25 GALLON TANK W/INSTR & SILICONE	1,234.13

PART NO.	DESCRIPTION	U.S. DOLLARS
170-0013	MOUNTING BLOCK, AGITATION DRIVE ASSEMBLY	44.68
19-00013	CONVERTER 24V TO 12V, 30 AMP DC TO DC	644.63
20-50017	IC, PROM., 512K, PROG. W/TEEJET 4.02 SOFTWARE (844AB)	138.47
28-01009	MOTOR ASSY LEGACY PUMP	1,782.64
28-01018	MOTOR ASSY, PISTON PUMP	1,981.50
28-01030	FRICTION WHEEL, ELECTRIC STEERING MOTOR	80.76
28-05003	MOTOR, HYDRAULIC, BLACK, PAINTED	3,157.07
28-10005	BRUSH, MOTOR MT500/600	28.53
307-0005	RIVET, POP 1/8" x 1/8" SS	7.35
307-0008	RIVET,1/8"D x 3/8"G,SST STEEL MANDREL	7.27
307-0009	SCREW MACH., 10-32 x 3" SST, P.H.	3.70
307-0015	SCREW SET, 10-32 x 3/16" SST, CUP POINT	10.73
307-0025	SPACER, NYLON 1/4" ID x 1/4" L	3.66
32-01044	SWITCH, TOGGLE, MOM-OFF- MOM SINGLE	38.89
32-01052	SWTCH,FOAM,LEFT-OFF-RIGHT JD AUTO/MANUAL CONTROLLERS	54.13
32-01053	SWITCH, INCREASE/DECREASEJD MANUAL CONTROLLER	93.11
32-02005	SWITCHBOOT, 12mm, TEEJET BLACK	46.89
32-02006	SWITCH WASHER, 12mm, TEEJET	3.66
32-02013	SWITCH BOOT, BLACK	17.74
32-02019	SWITCH BOOT, FOR TOGGLE SWITCH	30.47
32-04008	KEYPAD, RUBBER L6K	416.17
32-04009	SWITCH, KEYPAD, 3 POS. MOM	68.79
32-04010	SWITCH ASSY, REED, ROUND	114.70
32-04012	KEYPAD, CENTERLINE REMOTE	79.45
32-04013	REED SWITCH ASSEMBLY	107.14
32-04020	SWITCH ASSY, FOOT FIELDPILOT	318.00
32-04024	SWITCH ASSY, CAL, PISTON PUMP	66.49
32-04030	KEYPAD, CENTERLINE 220	79.45
32-04037	KEYPAD CL230 TEEJET VERSION	109.61
32-04039	SWITCH ASSY, REED RND 2 POS WP	75.36
32-04040	SWITCH, ENGAGE/DISENGAGE FIELDPILOT	71.07
32-04059	KIT, FIELDPILOT PRO FOOT SWITCH	318.00
32-50002	SWITCH, TOGGLE ON-FF SW631H/2	29.21
32-50003	SWITCH,TOGGLE ON-OFF MAST SW631H/2 X 2031	26.52
32-50006	SWITCH, PRESS. ADJUST CP36985-COMMAT	40.64
32-50007	SWITCH, BOOM CP36984-COMMAT	16.04
32-50008	SWITCH, MASTER CP21477-COMMAT	33.58
32-50010	SWITCH, MST, SUB-ASSY 22573-COMMAT	35.44
344BRL-23-03CCS	VALVE, BALL, 3/4", 3 RPM	362.91
350-0025	WASHER, FLAT, 1/4", SST 11/16" OD	1.94
350-0037	WASHER, FLAT,3/8" SST 1" OD	1.94
350-0040	WASHER, LOCK, 1/4" SPLIT RING, SST	1.94
350-0062	NUT, HEX, 1/4-20	1.81
350-0083	NUT, WHIZLOCK, 1/4-20, SS	1.64
350-0111	BOLT HEX 1/4-20 x 5/8 SST	0.83
35-02048	VALVE, CALIBRATION, SUB-ASSEMBLY	122.99
35-02054	POWERHEAD 7 SEC w METRIPK CONNECTOR	652.57
35-02083	VALVE, AUTORANGE, 1" PP, 3 SEC B SERIES	508.10
35-02084	VALVE, AUTORANGE, 1-1/2" PP, 3 SEC B SERIES	742.04
35-02085	VALVE, CONTROL, 1" PP 3 SEC B SERIES	432.12
35-02086	VALVE, CONTROL, 1-1/2" PP 3 SEC B SERIES	742.04
35-02087	VALVE, BALL LINEAR REG w/1" FITTINGS, 344BRL-24-01CCS	362.91
35-02089	VALVE, REGULATING, LOW FLOW 1"	349.23
35-02090	REGULATOR(WITH CONTR	742.04
35-02094	VALVE, REGULATING, 1" 12GPM 6 SECOND	349.23

# COMPREHENSIVE LIST

PART NO.	DESCRIPTION	U.S. DOLLARS	PART NO.	DESCRIPTION	U.S. DOLLARS
35-02099	VALVE, 1", 3 RPM	362.91	35-04070	ACTUATOR ASSY, 12V 3 RPM 3 PORT	306.75
35-02101	VALVE, 1" 3 RPM W/BSPT FITTINGS	362.91	35-04086	CARTRIDGE, FLDPLT PWM 1.1.GPM, D02	1,205.36
35-02105	VALVE, 1" BSPT, 3 RPM	432.12	35-04087	CARTRIDGE, FLDPLT, PWM 2.1-5.0GPM, D02	1,205.36
35-02112	VALVE, REG. w/FLANGE 3 RPM	362.91	35-04088	CARTRIDGE, FLDPLT, PWM 3.2-6.6GPM, D02	1,205.36
35-02114	VALVE REG. BRACKET MOUNT 18 SEC 344BRL	346.67	35-04097	CARTRIDGE, CB VALVE, CBPG-10-N-S-0-50	295.25
35-02115	VALVE, REG, 344BPR, 3/4" NPT, 344BPR-23-01CCS	349.23	35-05003	CARTRIDGE ASSY, 3 SEC, 8 GPM, EXR-4	1,127.59
35-02117	VALVE, EXR-4 5 GPM 3 SEC 2/#12 PORT	1,514.76	35-05005	CARTRIDGE ASSY, 3 SEC, 13 GPM, EXR-4	1,127.59
35-02118	VALVE EXR-4 5 GPM 7 SEC 2/#12 PORT LOAD SENSE	1,514.76	35-05007	CARTRIDGE ASSY, 7 SEC, 13.8 GPM, MP280, EXR-4	2,010.03
35-02119	VALVE EXR-4 8 GPM, 3 SEC 3/#12 PORT	1,514.76	35-05009	CARTRIDGE ASSY, 3 SEC, 15 GPM EXR-4	1,127.59
35-02120	VALVE, EXR-4 8 GPM 3 SEC 2/#12 PORT P.R. WHITE HYD	2,503.69	35-05010	CARTRIDGE ASSY, 7 SEC, 15 GPM EXR-4	1,127.59
35-02121	VALVE, EXR-4 13 GPM 3 SEC 3/#12 PORT	1,910.31	35-05011	CARTRIDGE ASSY, 3 SEC 20 GPM, EXR-4	1,127.59
35-02122	VALVE, EXR-4 13.8 GPM 7SEC, 2/#12 PORT MP280	2,503.69	35-05013	CARTRIDGE ASSY, 3 SEC, 30 GPM, EXR-4	1,127.59
35-02123	VALVE, EXR-4 15 GPM 3 SEC 3/#12 PORT	1,514.76	35-05014	CARTRIDGE ASSY, 7 SEC, 30 GPM, EXR-4	1,127.59
35-02124	VALVE, EXR-IV 15GPM 7 SEC 2/#16 PORT LOAD SENSE	1,467.48	35-05015	CARTRIDGE ASSY, 3 SEC, 50 GPM, EXR-4	1,127.59
35-02125	VALVE, EXR-4 20 GPM 3 SEC 3/#12 PORT	1,514.76	35-05016	CARTRIDGE ASSY, 7 SEC 50 GPM, EXR-4	1,127.59
35-02126	VALVE, EXR-4 20 GPM 3 SEC 2/#12 PORT P.R. WHITE HYD	2,503.69	35-50021	VLV,SOL SHUT-OFF1 BANK AA144A-1	170.44
35-02127	VALVE, EXR-4 30 GPM 3 SEC 3/#12 PORT PRESS RELIEF	2,010.03	35-50023	VLV, SOL.SHUT-OFF, 3 BANK AA144A-3	520.13
35-02128	VALVE, EXR-4 30 GPM 3 SEC 3/#12 PORT	1,514.76	35-50024	KIT, REPAIR, 144A PK-AB144A-1-KIT	36.30
35-02129	VALVE, EXR-4 50 GPM,3 SEC 3/#16 PORT PRESS RELIEF	2,010.03	35-50025	VLV, SOL. LG COIL, 1 BANK AA144P-1	234.90
35-02130	VALVE EXR-4, 50 GPM, 3 SEC, 3/#16 PORT	1,761.48	35-50027	VLV, SOL. LG COIL, 3 BANK AA144P-3	704.48
35-02132	VALVE, REG, 346BR, FLNG 6 SEC	742.04	35-50028	KIT, REPAIR, 144P PK-AB144P-1-KIT	46.20
35-02135	VALVE 3/4	362.91	35-50029	VALVE, REG. 244C-3/4 21773-244C-3/4	185.83
35-02140	VALVE, 3/4" 6 SEC 1" NPT PP/SS, S F-AMP	432.12	35-50030	VALVE, REG. BSPT 244C-3/4 B21773-244C-3/4	185.83
35-02141	VALVE, TJ REGULATING, 346BPR, 50 SERIES FLANGE	742.04	35-50033	KIT, SPARE PARTS PK-AB244C-KIT	18.83
35-02142	VALVE, TJ REGULATING, 346BPR, 1-1/4" NPT	742.04	35-50049	VALVE, REG. 244C-3/4 AA244C-3/4 (w/o CONN)	168.39
35-02143	VALVE, TJ REGULATING, 346BPR, 1-1/2" NPT	742.04	35-50050	VALVE, REG. BSPT 244C-3/4 AAB244C-3/4 (w/o CONN)	168.39
35-02144	VALVE, MT 3 WAY, 346 BPR, 50 SERIES FLANGE	742.04	401-0003	CABLE,POWER,TASC PUMPS	178.13
35-02145	VALVE, MT 3 WAY 346BPR, 1-1/4" NPT	742.04	401-0008	CABLE, POWER, PUMP ASSY, 18', 15 A, PACKARD	178.13
35-02146	VALVE, MT 3 WAY 346BPR, 1-1/2" NPT	742.04	401-0010	CABLE, POWER, TASC/ARC CONSOLES, 18', 5 A., PACK	206.31
35-02149	VALVE EXR-4 20 GPM 3 SEC 3/#12 PORT PRESS. RELIEF	2,010.03	401-0011	CABLE, POWER 3 LEAD x 2' W/PACKARD CONNECTOR	127.10
35-02150	VALVE, 3/4" REGULATING 3 PORT, BPR w/MT PINOUTS	400.74	401-0012	CABLE, POWER, 5 LEAD W/PACKARD CONN, 3@6',2@2'	231.06
35-02151	VALVE FIELDPILOT CC, LS	2,241.62	401-0016	CABLE POWER, 1 LEAD, 2'/0.6M	84.80
35-02155	VALVE COUNTER BALANCE 0-20 GPM 5000 PSI	880.85	401-0102	CABLE,POWER,EXTENSION 14 GA, PACKARD	149.92
35-02180	VALVE, FLDPLT, PWM, CC 2.1GPM	3,093.57	402-0003	CABLE,Y,D,j. RADAR	206.31
35-02182	VALVE, FLDPLT, PWM, OC 4.0GPM	3,727.48	402-0004	CABLE, SOLENOID EXTENSION 5 VALVE, 18'	289.16
35-02183	VALVE, FLDPLT, PWM, OC 1.1GPM	3,921.80	402-0005	CABLE, Dj RADAR EXTENSION 18'	206.31
35-02184	VALVE, FLDPLT, PWM, OC 7.9GPM	3,727.48	402-0007	CABLE,SOLENOID,3 SECTION, 25', ISC/TASC	484.92
35-02185	VALVE, FLDPLT 2.1 GPM OC, PWM	3,921.80	402-0009	CABLE, EXT 18/2 x 18' AGITATION/TASC FLOW	144.61
35-02201	VALVE, EXR-4 50 GPM, 7 SEC , 2 SAE #16 PORTS,	1,467.51	402-0011	CABLE, SOLENOID,5 SECTION 18', CCI/TASC	567.80
35-03000	MANIFOLD, 2 SAE #16 PORTS W/SAE #4 LOAD SENSE PORT	339.91	402-0023	CABLE,TASC,MTRZD,VLV INT/ SPRAY SYSTEMS VALVE 15'	109.37
35-03003	MANIFOLD, W/RELIEF	1,764.94	402-0024	CABLE,EXTENSION,VALVE,15'	137.57
35-03004	MANIFOLD, 3 PORT #12	576.58	402-0028	CABLE, 25' EXTENSION,TASC MOTORIZED VALVE INTERFACE	165.90
35-03005	MANIFOLD, 3 PORT SAE #12 W/RELIEF	1,491.03	402-0035	CABLE, SPEED EXTENSION 30'	178.13
35-03006	MANIFOLD, 3 PORT SAE #16 W/RELIEF	1,186.76	402-0038	CABLE, ADAPTER, RAVEN RADAR	149.92
35-03015	MANIFOLD,w/SAE #12 PORTS w/LOAD SNSE #4 SAE PLG	557.96	402-0039	CABLE,EXTENSION,VALVE,3'	127.10
35-03018	MANIFOLD FIELDPILOT OC P & EF-12,A,B, & T-08	3,230.52	402-0040	CABLE, ADAPTER, 18', Dj ANHYDROUS FLOWMETER	149.92
35-03021	MANIFOLD, FLDPLT CC D02 ALL PORTS #6	2,004.24	402-0065	CABLE, ADAPTER,FLOWMETER TO RATE SENSOR PINOUT	109.37
35-04001	POWER HEAD, 3 SEC	694.95	404-0001	CABLE,CCI,FS/AP, 18'	265.54
35-04002	POWER HEAD, 7 SEC	652.57	404-0003	CABLE, 25' CHEMICAL FLOW SENSOR ASSEMBLY	149.92
35-04065	ACTUATOR ASSY, 12V 6 RPM	306.75	404-0009	CABLE, FLOW SENSOR 18ft CCI/TASC SYSTEMS	218.95
			404-0022	CABLE,FLOW CONTROL, WITH 20' POWER SUPPLY CABLE	255.82

# COMPREHENSIVE LIST

PART NO.	DESCRIPTION	U.S. DOLLARS
404-0023	CABLE ASSY, CONSOLE INTERFACE, RAVEN FLOWMETER	255.82
404-0024	CABLE, ADAPTER MID-TECH TASC CONSOLE TO RAVEN VLV	137.57
404-0037	CABLE, SOLENOID HARNESS, 9 VALVE x 25 FT	641.87
404-0039	CABLE, 25' FLOWMETER EXT/ OR 6 POS CFM SIGNAL	165.90
404-0045	CABLE, FLOWMETER EXTENSION	149.92
404-0049	CABLE, ADAPTER FAN TACH DJ SENSOR	121.75
404-0061	CABLE, FLOW CONTRL TASC/ Dj 360 SLOT SENSOR	255.82
404-0071	CABLE, VALVE ADAPTER #60 WIRING, K.Z.	149.92
404-0073	CABLE, RUN/HOLD SWITCH TASC/AGLOGIX	132.21
404-0088	CABLE, RADAR ADAPTER 10' JD8000 SERIES TRACTOR	195.84
404-0104	CABLE, ADAPTER FAN TACH MIDTECH SENSOR	121.75
405-0035	INTERFACE, TASC/ARC 5 SOL VALVE AP/GSO/IS	1,174.91
405-0036	INTERFACE, TASC 5 BM IS GSO	391.42
405-0037	INTERFACE, TASC/ARC 3 SOL VALVE AP/GSO/IS	1,232.57
405-0038	INTERFACE, TASC 9 BS IS GSO	567.80
405-0043	INTERFACE, Dj HYDR VALVE DRIVER	521.89
405-0044	INTERFACE, 12' FLOW METER DIVIDE BY 16	497.30
405-0053	INTERFACE, TASC/ARC 3 MTR VALVE AP/GSO/IS	1,650.72
405-0054	INTERFACE, TASC/ARC 9 SOL VALVE AP/GSO	1,671.38
405-0056	INTERFACE, CABLE, MID-TECH FLOWMETER	507.81
405-0059	INTERFACE, 3 BS/MS	403.82
405-0068	INTERFACE CABLE, FLOW CONTROL/BOOM, ARC-AIR-RIDE	691.21
405-0071	INTERFACE, RATE SENSOR DIVIDE BY 4	206.31
405-0074	HARNESS, FLOW CONTROL/ POWER	845.50
405-0075	SWITCHBOX, SINGLE BOOM OFF/AUTO/GSO	595.80
405-0081	INTERFACE, REMOTE PRIME PUMP MOUNT	386.27
405-0086	INTERFACE, TASC CONSOLE/ 5 SECT. SOLENOID/ HAND GUN	986.57
405-0087	HARNESS, ARC/TASC FLOW CONTROL (RoGator)	1,579.67
405-0088	INTERFACE, TASC 9 SEC SOL GSO/AP/HG	1,317.04
405-0092	INTERFACE, ROADSIDE TASC BOOM 9 SEC	623.36
405-0098	SWITCHBOX, DUAL MID-TECH W/OFF AUTO GSO	1,057.84
405-0110	SIMULATOR, RADAR MIDTECH	602.12
405-0113	INTERFACE, VALVE DRIVER REVERSE ACTION	521.89
405-0136	CABLE, BOOM STATUS IS/GSO	403.82
405-0143	CABLE, VALVE DRIVER TASC/ ARC SYSTEMS	517.12
405-0144	INTERFACE, 12' RAPID CHCK FLOWMETER DIVIDE BY 4	497.30
405-0156	CABLE, FLOW CONTROL, TASC PATRIOT	467.07
405-0174	HARNESS, PULL TYPE POWER/ FLOW CONTROL	825.08
405-0187	HARNESS, ARC/TASC FLOW CONTROL (TERRA GATOR)	2,721.97
405-0188	INTERFACE, 17", RAPID CHK FLOWMETER DIVIDE BY 4	469.13
406-5020	CABLE, EXT MAIN HARNESS 20ft 14POS AMP	349.13
406-5030	CABLE, EXT MAIN HARNESS 30ft 14POS AMP	349.13
45-04001-40	CABLE, EXTENSION, 40"/1M AMP SS 1.5, 2 POSITION	63.12
45-04001-80	CABLE, EXTENSION, 80"/2M AMP SS 1.5, 2 POSITION	67.52
45-04002	CABLE, POWER, 4 POS DTP TO 2 POS WP TWR, 7'/2m	95.41
45-04005-06-20	HRNS,NZ, DYNAJET, AMPSS 1.5, 20"/50cm, 6NOZZLE	542.15
45-04005-06-20-END	HRNS,NZ, DYNAJET, AMPSS 1.5, 20"/50cm, 6NZ, W/END TERM.	570.83

PART NO.	DESCRIPTION	U.S. DOLLARS
	HRNS,NZ, DYNAJET, AMPSS 1.5, 20"/50cm, 6NZ, W/START TERM.	570.83
45-04005-08-20	HRNS,NZ, DYNAJET, AMPSS 1.5, 20"/50cm, 8NOZZLE	619.60
45-04005-08-20-END	HRNS,NZ, DYNAJET, AMPSS 1.5, 20"/50cm, 8NZ, W/END TERM.	674.39
	HRNS,NZ, DYNAJET, AMPSS 1.5, 20"/50cm, 8NZ, W/START TERM.	674.39
45-04006-03	SENSOR CAN EXT. 3'/1m	111.19
45-04006-07	SENSOR CAN EXT. 7'/2m	117.97
45-04006-13	SENSOR CAN EXT. 13'/4m	131.60
45-04006-20	SENSOR CAN EXT. 20'/6m	145.18
45-04006-END	TERMINATOR, SENSOR CAN END, MALE	86.38
	TERMINATOR, SENSOR CAN START, FEMALE	86.38
45-04008	CABLE POWER ADAPTER LIGHTER US TO CXA 8.5 FT	136.03
45-04010-15	CABLE, WAS EXTENSION, 15', 3 POS WP	71.68
45-04016	CABLE, RAVEN REG VALVE ADAPTER, 744/844	25.70
45-04029	CABLE, ADAPTER, DIN TO REG. VALVE, 12", REVERSE POLARITY	46.77
45-04036	CABLE, ADAPTER, REVERSE POLARITY REG. VALVE, 6"	38.60
45-04037	CABLE, ISOBUS 11783, IN-CAB, 9P AMP	204.18
45-04038	CABLE, REG VALVE ADAPTER, RAVEN HARNESS, 8"	27.26
45-04040	CABLE, NH SP3XXF BOOM INTERFACE, 10 SECTION	644.17
45-04053	CABLE, ETHERNET, MATRIX 908	150.30
45-04060	CABLE, ADAPTER, MATRIX 908 TO 570/840 CABLES	205.00
45-04063	CABLE, POWER ADAPTER, M908 TO FP TJ CAN	39.87
45-04068	CABLE, RADION CAN TO M908, 6 POS DTM W/ TERM., 7'	226.70
45-04069	CABLE, ADAPTER, M908 TO 570/840 CABLES, GNSS IN	226.70
45-04072	CABLE, ADAPTER, MATRIX (NO PWR) TO RAVEN CONSOLE	95.01
45-04084	CABLE, ADAPTER, STATUS SENSE, AMP SS TO SPADE TERMINALS	43.13
45-04087	CABLE, 1', BELT EXT. 3POS DT - 3POS WP SHROUD	102.01
45-04088	ADAPTER, 9 POS AMP TO IC45 6 POS DT, SMITHCO, W/TERMINATOR	165.11
45-04089	CABLE, ADAPTER, 9 POS AMP TO 6 POS DTM	153.53
45-05037	CABLE, 2 POSITION, BATTERY	102.32
45-05057	CABLE, FLOW SENSOR, WEATHERPACK 3 POSITION	63.67
45-05091	CABLE, BOOM SENSE, EXTENSION, JD 4700	178.13
45-05098	CABLE, PUMP CONTROL 40FT.	255.82
45-05107	CABLE ASSY, PUMP/BIN SYS. PWR ADAPTER 19.5'	268.06
45-05114	CABLE, 20 FT SENSOR EXT. GEAR SPEED	195.84
45-05132	CABLE, POWER 3 M	192.21
45-05134	CABLE, ANTENNA, 5 METER, TNC-TNC	176.69
45-05135	CABLE, ANTENNA, 5 METER, TNC-BNC	192.21
45-05147	CABLE, RADAR SPEED	165.90
45-05157	CABLE, GRANULAR SWITCHBOX	456.75
45-05160	CABLE, EXT., POWER 10 FT WP TO WP 15 AMP	72.40
45-05161	CABLE, EXT., POWER 20FT WP TO WP 15 AMP	137.57
45-05162	CABLE, EXT., POWER 30 FT WP TO WP 15 AMP	165.90
45-05164	CABLE ASSY, F.M. SENSOR SIGNAL	19.46
45-05167	INTERFACE, FLOWMETER RAPID CHECK, SPX	507.81
45-05175	CABLE, EXTENSION 10' LIGHTBAR	368.44
45-05204	CABLE, 2.5m SENSOR	269.91

# COMPREHENSIVE LIST

PART NO.	DESCRIPTION	U.S. DOLLARS	PART NO.	DESCRIPTION	U.S. DOLLARS
45-05205	CABLE, 12m	107.08	45-05489	CABLE EXTENSION, AIR MATIC	386.60
45-05206	CABLE, ADAPTER, FAN TACH MARK, IV	178.13	45-05490	CABLE, END, AIR MATIC	488.36
45-05210	CABLE DIRECT CONSOLE	702.39	45-05492	CABLE ADAPTR SFM, HAGIE 05 AND NEWER DT CONN.	164.03
45-05279	CABLE, POWER CIGARETTE LIGHTER	127.10	45-05495	CABLE, RX370P SPEED ONLY	218.70
45-05280	CABLE, CONSOLE & POWER TO DISCONNECT	199.26	45-05501	CABLE GPS EXT. 25'	295.36
45-05290	CABLE, EXT., 15', LIGHTBAR	394.30	45-05504	CABLE, ADAPTER 12", 801 FM TO 3 POS WP	74.11
45-05298	CABLE, 12', 2 POS. BATTERY	127.10	45-05508	CABLE ADAPTER CL220 TO RAVEN CONSOLE	120.82
45-05299	CABLE ASSY, CONTROL PUMP ENCLOSURE	41.02	45-05562	CABLE, DATA, SUB ASSY CL230	379.36
45-05300	CABLE ASSY, POWER PUMP ENCLOSURE	38.98	45-05564	POWER CABLE, CL220 FIELDPILOT SCM	125.14
45-05301	CABLE ASSY, SIGNAL PUMP TO TASC	151.44	45-05578	CABLE SPEED, CL230	69.71
45-05302	CABLE ASSY, POWER PUMP TO POWER	231.06	45-05582	CABLE, 3 POS. BATTERY 2' w/15 AMP FUSES	197.55
45-05309	CABLE, PUMP CONTROL, KEYPAD	16.04	45-05588	CABLE, CENTERLINE 220 DATA	96.87
45-05315	CABLE, ADAPTER, 801 FLOWMETER	93.57	45-05589	CABLE ADAPTER, PRESSURE SENSOR	208.77
45-05322	CABLE ASSY, GROUND, TASC	306.88	45-05596	HARNESS, SDM 9 SECT. TEEJET 844E	682.63
45-05324	CABLE, POWER, CENTERLINE	226.22	45-05605	CABLE, GPS SPLITTER CL CLASSIC TO DB9 SKT	247.90
45-05338	CABLE, GPS DATA w/12 POS. DT, CENTERLINE	226.22	45-05609	HARNESS, BOOMPILOT, GENERIC	682.63
45-05339	CABLE, ADAPTER, INTRFC TO 350P w/DEUTSCH CONNECTOR	172.48	45-05612	CABLE, END AIRMATIC 18.3 METERS	352.78
45-05340	CABLE, DEUTSCH TO DB9 AND POWER IN	226.22	45-05615	CABLE, MATRIX SPD OUT/SENSE IN 4PG CXA TO 4 PIN AMP	126.06
45-05343	CABLE, EXTENSION 10' CENTERLINE	239.29	45-05617	CABLE CAMERA EXT 20FT	204.86
45-05348	CABLE, PRESSURE SENSOR, 4-20MA TO L6K	68.79	45-05618	CABLE CAMERA EXT 60FT	269.30
45-05350	CABLE, COM 1 & 2 WITH POWER IN	318.86	45-05619	CABLE, SMA MALE TO TNC MALE, 20'	211.44
45-05352	CABLE SIGNAL EXT. 20' LEGACY PUMP	286.38	45-05620	CABLE, SMA MALE TO TNC MALE, 30'	328.27
45-05354	CABLE, GPS DATA, DUAL OUT w/SINGLE DB9	239.29	45-05626	CABLE POWER CAN, ADAPTER	323.30
45-05366	WIRING ASSY, 854 INTERNAL	493.73	45-05628	CABLE ADPT. PWR 4 POS AMP PINS, TO 2 POS WP TWR	40.74
45-05381	CABLE 3 POS. BATTERY 12' w/15 AMP FUSES	209.92	45-05629	CABLE ADPT, CL220 TO CL230 CAN	214.80
45-05385	CABLE, POWER FUSED, 744	74.11	45-05630	CABLE, ADPTR NULL MODEM DB9MM MALE TO MALE (PINS)	18.67
45-05387	CABLE, MID-TECH FLOWMETER TO TEEJET HARNESS	49.71	45-05631	CABLE, GPS EXT. 50'	344.69
45-05396	CABLE, POWER 3 POS AMP TO 3-2 POS WP	199.26	45-05632	CABLE SPEED INTERFACE JD PROGATOR '08 AND NEWER	229.93
45-05397	CABLE, Y, STARFIRE TO DB9	226.22	45-05634	HARNESS 12 ROW BBP-SDM TRU COUNT	645.90
45-05425	CABLE, BOOM CONTROL Y	93.57	45-05645	CABLE POWER ADAPTER LIGHTER US TO CXA 4 FT	126.06
45-05429	CABLE, 70 SERIES, SPEED AREA	155.26	45-05650	CABLE, POWER ASSY CL220 COBO	105.62
45-05430	CABLE, ADAPTER, GPS SIM DB9, SKTS TO CXA PINS	153.15	45-05674	CABLE PRESSURE SENSOR 3'	65.37
45-05431	CABLE, ADAPTER TEEJET VALVE DRIVER	38.91	45-05676	CABLE, GPS ANT. EXT. 25' SMA MALE TO SMA FEM	269.30
45-05434	CABLE, GPS SPEED 854	221.55	45-05678	CABLE, RXA-25 ANTENNA 20' SMA MALE TO SMA MALE	247.90
45-05436	CABLE, FILL FLOW 70 SERIES	176.43	45-05690	CABLE SENSOR, EXT 5FT.	72.40
45-05439	CABLE, FLOW VOLUME	155.26	45-05693	CABLE, JD 7X, 8X, 30 SERIES SPEED ADAPTER	433.26
45-05440	CABLE, Dj RADAR EXTENSION, 6'	206.31	45-05694	CABLE, 32', SPINNER EXT. 3 POS DT PLUG-3POS MP	171.62
45-05441	CABLE, TILT COMP. DB9	194.10	45-05709	HARNESS, BOOMPILOT, NON-AGCO W/ RAVEN 4400 - 4600	682.63
45-05442	CABLE, TILT COMP CXA	215.52	45-05719	HARNESS, BOOMPILOT, TEEJET 844	682.63
45-05450	CABLE DUAL RPM, 70 SERIES CONSOLE	218.70	45-05720	HARNESS, BOOMPILOT, RAVEN 440-460	682.63
45-05451	CABLE, 10 FT EXT. 70 SERIES 12 POS. MATE-N-LOK	197.55	45-05738	HARNESS, BOOMPILOT, RAVEN SPRA COUPE 3000/4000 SERIES	1,312.71
45-05452	CABLE, SPEED/PRESSURE 70 SERIES	197.55	45-05740	HARNESS, BOOMPILOT, WILLMAR W/ M-T Cont., Air Ride, Eagle 8100, 8500, Rangers	682.63
45-05454	CABLE FLOW CONTROL, 4-WIRE EXTENSION, 25'	120.02	45-05741	HARNESS, BOOMPILOT, SPRA COUPE 7XXX w/ RAVEN 4000/5000	682.63
45-05457	CABLE ASSY, CL220 POWER	75.18	45-05742	HARNESS, BOOMPILOT, 844 CLASSIC, US	682.63
45-05458	CABLE, CENTERLINE 220, LIGHTER ADAPTER	107.79	45-05743	HARNESS, BOOMPILOT, SINGLE SECTION	682.63
45-05459	CABLE, CENTERLINE 220 GPS SIMULATOR	133.65	45-05747	HARNESS, BOOMPILOT, HAGIE, SPLIT SIGNAL, RAVEN 460	682.63
45-05460	CABLE ASSY, GPS ANT. MCX RA-SMA PM 7.5" L	45.93	45-05749	HARNESS, BOOMPILOT, ROGATOR '03 - '06, DT CONN. 8 POS.	682.63
45-05465	CABLE, FLOWMETER ADAPTER, DT TO RAVEN CONN.	107.62	45-05759	PROTOTYPE, Y CABLE	105.77
45-05466	CABLE 834 WETBLADE SYSTEM	552.28			
45-05467	CABLE SM5 BOOM DRIVER/POWER	215.52			
45-05471	CABLE, ADAPTER WP TO CENTERLINE 220	69.15			
45-05472	CABLE, MT, TO D-SERIES DIVIDE BY 2, 12"	197.55			
45-05476	CABLE, CL220 REV 1, GPS DATA/PROGRAMMING	163.87			
45-05478	CABLE, BATTERY, POWER CL220	133.65			
45-05479	CABLE SM5 TO RAVEN 4400 AND RAVEN 4600	622.58			
45-05484	CABLE FM ADAPTER SPRA-COUPE 7450/7650	40.64			

COMPREHENSIVE LIST



# COMPREHENSIVE LIST

PART NO.	DESCRIPTION	U.S. DOLLARS	PART NO.	DESCRIPTION	U.S. DOLLARS
45-05762	CABLE, 32' BELT EXT. 3 POST. DT RECP-3 POS. MP	171.62	45-05942-10	CABLE, POWER, 6 GA, DEUTSCH 2 POS., 10'	315.96
45-05763	HARNES 5 BOOM SWITCHBOX TO 405-0068	703.48	45-05942-20	CABLE, POWER, 6 GA, DEUTSCH 2 POS., 20'	406.23
45-05765	CABLE, MATRIX SPEED OUT/SENSE IN	141.84	45-05942-30	CABLE, POWER, 6 GA, DEUTSCH 2 POS., 30'	488.94
45-05772	CABLE, POWER MATRIX SUPPORT PACKAGE	95.52	45-05942-40	CABLE, POWER, 6 GA, DEUTSCH 2 POS., 40'	571.68
45-05775	CABLE, POWER MATRIX 10FT, 5A	140.15	45-05943	CABLE, BATTERY, 6 GA, 2 POS. DT, 60 AMP FUSE	165.53
45-05783	CABLE, MATRIX TO 370P, ADAPTER TO CONXALL	323.29	45-05948-03	CABLE, 3' EXTENSION, 2 POS. MP150	37.67
45-05784	CABLE, ADAPTER, SLOT SNSR 3 POS SHRD TO DT RECP.	97.16	45-05948-06	CABLE, 6' EXTENSION, 2 POS. MP150	52.69
45-05786	CABLE, 20' FOR RXA-30 ANTENNA	247.90	45-05953	HARNES, AEROS 9040 w/ISO CAN	624.22
45-05787	CABLE, 30' FOR RXA-30 ANTENNA	366.34	45-05957	CABLE, RX520/RX720 TO POWER & SERIAL COM 1	234.36
45-05801	CABLE JD-EHPS TO TEEJET	89.34	45-05963	CABLE, CAN BULKHEAD, IN-CAB, 12 POS DT PINS	221.76
45-05803	CABLE, 4 POS, DT HOUSING TO 4 POS AMP JPT 10'	126.75	45-05965	CABLE, CAN, OUTSIDE CAB, 12 POS DT SKTS	191.67
45-05805	CABLE, IN-CAB CONNECTOR Y ISOBUS	283.76	45-05968	HARNES, AEROS 9040, UT,TJT JUNCTION BOX ONLY	234.36
45-05817	CABLE, 20', SPINNER 3POS DT PLUG - 3POS DT	178.98	45-05970	CABLE, MATRIX 430 POWER/SENSE/SPEED (w/ SWITCH)	260.43
45-05821	CABLE, PSI SWITCH, FLDPLT TO 3 POS DT 15'	80.43	45-05971-05	CABLE, PWR, 4 POS DTP, 10GA, 5'/1.5m	135.42
45-05822	Cable,PSI Switch, 15', FLDPLT, to 2 POS WP	56.56	45-05971-10	CABLE, PWR, 4 POS DTP, 10GA, 10'/3m	165.52
45-05824	CABLE, 570VT TO INCAB MOD. ISOBUS, 6'	375.53	45-05971-20	CABLE, PWR, 4 POS DTP, 10GA, 20'/6m	245.60
45-05825	CABLE, JD VT TO INCAB MOD. ISOBUS	250.36	45-05971-30	CABLE, PWR, 4 POS DTP, 10GA, 30'/9m	327.41
45-05831	HARNES, BOOMPILOT, 10 AND NEWER HAGIE STS	682.63	45-05971-40	CABLE, PWR, 4 POS DTP, 10GA, 40'/12.2m	394.82
45-05834	CABLE, POWER ADAPTER, 6' US LIGHTER TO 9 POS. AMP	109.24	45-05971-50	CABLE, PWR, 4 POS DTP, 10GA, 50'/15.2m	477.68
45-05844	HARNES, BOOMPILOT, 12 POS ROGATOR DT-12 1054/1254/1264	682.63	45-05978	CABLE, POWER "Y", 1', WP, 2 POS SHD TO (2) 2 POS TWR	47.55
45-05845	CABLE POWER CAN, RS232 TO CNXL 8PG w/TERM. (FRANCE)	370.49	45-05979	CABLE, RX520/RX720 TO POWER& DUAL COM PORTS	381.35
45-05851	CABLE, PRESS. SWITCH ADAPTOR, 2.4M	59.43	45-05980-10	CABLE, PWR Y, 4 POS DTPTO 2 - 4 POS DTP 10'	160.18
45-05855	TERMINATOR, FEMALE, TIP MONITOR	86.38	45-05980-15	CABLE, PWR Y, 4 POS DTPTO 2 - 4 POS DTP 15'	171.70
45-05856	TERMINATOR, MALE, TIP MONITOR	86.38	45-05988	TERMINATOR, 4 POS DT,SKTS	90.09
45-05857	CABLE, SENSOR BUS EXTENSION, 3'	92.12	45-05989	TERMINATOR, 4 POS DT, PINS	90.09
45-05858	CABLE, SENSOR BUS EXTENSION, 6'	99.79	45-05997-15	CABLE, POWER Y, 4 POS DTP SKTS TO (2) 2 POS DTP PINS, 15'	293.04
45-05859	CABLE, SENSOR BUS EXTENSION, 12'	107.46	45-05998-01	CABLE, POWER, 4 POS DTP SKTS TO 2 POS DTP PINS, 1'	112.87
45-05860	CABLE, 32', BELT EXT. 3POS DT - 3POS WP SHROUD	216.61	45-05998-05	CABLE, POWER, 4 POS DTP SKTS TO 2 POS DTP PINS, 5'	175.17
45-05861	CABLE, 32', SPINNER EXT. 3POS DT - 3POS WP TOWER	125.93	45-05998-10	CABLE, POWER, 4 POS DTP SKTS TO 2 POS DTP PINS, 10'	204.87
45-05864	CABLE, SENSOR BUS EXTENSION, 35'	230.20	45-06501	HARNES, DCM F.C. SINGLE SENSOR	393.35
45-05865	CABLE, CAMERA EXT., 30'	243.14	45-06503	HARNES, DCM, LEGACY PUMP	403.82
45-05867	CABLE, POWER ADAPTER, COBO TO CONXALL, 235cm	153.08	45-06516	HARNES, DCM SENSORS A/D/E/	349.13
45-05868	CABLE, EXT., FOOT SWITCH FOR 45-05740	36.77	45-06517	HARNES DCM LEGACY PUMP w/AGITATION	403.82
45-05878	CABLE, ISOBUS IN-CAB Y, 4 POS DT TO 9 POS AMP	268.73	45-06524	HARNES, DCM ALL SENSORS A,B,C,D,E, & F	349.13
45-05884	HARNES, AEROS 9040 BASIC FUNCTION	490.41	45-07500	HARNES, DCM POWER/SPEED	298.49
45-05886	CABLE, PRESSURE SENSOR, 25'	111.30	45-07602	CABLE, ISM, 10 BOOM, IS GSO	685.84
45-05887	CABLE, PRESSURE SENSOR, 3'	51.82	45-07607	CABLE, AEROS ISM, W/12 POSITION DT	662.89
45-05892	ADAPTER, TFMI TO TJ CAN	309.86	45-07608	CABLE, ISO ISM w/6 POS DTM	405.00
45-05898	CABLE, MATRIX AUXILIARY	330.86	45-07609	CABLE, ISOBUS ISM,15 BOOM+ MASTER, w/6 POS DTM	480.37
45-05900	CABLE, EXTENSION, SENTRY 6140, 5'	153.50	45-07610	CABLE, ISOBUS ISM, ALL INPUTS	487.90
45-05901	CABLE, EXTENSION, SENTRY 6140, 10'	172.69	45-07703	CABLE, SCM TO POWER & FIELDPILOT VALVE HARNES	148.88
45-05902	CABLE, EXTENSION, SENTRY 6140, 20'	222.54	45-07704	CABLE, SCM TO POWER, FP VALVE & MASTER	253.73
45-05903	CABLE, EXTENSION, SENTRY 6140, 40'	329.91	45-07706	HARNES, SCM -CL220	341.58
45-05904	CABLE, SPEED ADAPTER, AMP 4 SKT TO RADION CONSOLE	133.44	45-07708	HARNES, BASIC, SCM L6K	436.33
45-05905	CABLE, POWER, 16 GA, 5 AMP, 11'	99.25	45-07711	CABLE, 12" CAN EXTENSION	76.02
45-05914	CABLE, CAN, RADION TO MATRIX, 5'	273.50	45-07716	HARNES, TGM/AGM CAN TEE	230.65
45-05920	CABLE, RADION CAN TO TEEJET CAN, 4 POS. WP	189.92	45-07718	HARNES, SCM SHORT	381.08
45-05925	CABLE, POWER CAN, 3m	312.14	45-07727	CABLE, SCM TO UNIPLOT ESM	247.06
45-05930	CABLE, ADAPTER, DIN TO REG. VALVE, 12"	46.77	45-08012	CABLE, EXT., CAN ,12FT	289.16
45-05932	CABLE, ADAPTER, DIN TO CVX VALVE CONNECTION, 12"	70.64	45-08101	TERMINATOR, CAN MALE, WP, AS SHIPPED	65.96
45-05937	CABLE, CAN STEERING ANGLE SENSOR, 5m	310.19			

# COMPREHENSIVE LIST

PART NO.	DESCRIPTION	U.S. DOLLARS
45-08102	TERMINATOR, CAN FEMALE, WP, AS SHIPPED	65.96
45-08104	CABLE CAN CONVERSION KIT, GEN I TO GEN II	291.06
45-08106	CABLE, EXT. 6' WP, AS SHIPPED	128.81
45-08112	CABLE, CAN EXT. 12' WP AS SHIPPED	149.92
45-08117	CABLE, CAN EXT. 20' WP AS SHIPPED	158.88
45-08118	CABLE, CAN EXT. 30' WP AS SHIPPED	206.31
45-08120	CABLE, CAN TEE TO 6 SOCKET DEUTSCH DTM, 6 FOOT	170.23
45-08121-05	CABLE, EXT., 6 POS.DT CAN, 5'	134.82
45-08121-10	CABLE, EXT., 6 POS.DT CAN, 10'	145.02
45-08121-20	CABLE, EXT., 6 POS.DT CAN, 20'	165.41
45-08404	CABLE ASSY CAN "T" 6'	81.20
45-09017	HARNESS, HITCH IC18 12.5" w/BELT & SPINNER	1,211.48
45-09020	HARNESS, IC18 HITCH, 10' ISOBUS w/2nd ECU CONNECT	1,869.09
45-09023	CABLE, 20' EXT. ISOBUS HITCH TO IBBC	1,220.44
45-09024	HARNESS, 30' EXT. ISOBUS HITCH TO IBBC	1,420.38
45-09025	HARNESS, 40' EXT. ISOBUS HITCH TO IBBC	1,535.70
45-09026	HARNESS, IC18 TO ISOBUS HITCH	1,000.19
45-09027	HARNESS, HITCH TO IC18, 12' w/BELT AND SPINNER	1,176.19
45-09029	CABLE, TEEJET IN-CAB "Y",	288.28
45-09030	CABLE, TEEJET IN-CAB ""Y"";9 POSITION AMP	288.28
45-09034	CABLE, TEE, ISOBUS TFM1 TO DEERE 12 POS. AMPSEAL 16	293.49
45-09035	CABLE, TEE, ISOBUS TFM1 TO 6 POS. MP150 RAVEN	293.49
45-09036	CABLE, TEE, ISOBUS TFM1 TO 8 POS. GT280, CASE IH	293.49
45-09037	HARNESS, ISO-TFMI	359.23
45-09038	CABLE, ISO HITCH TO 4 POS. DT SKTS	293.49
45-09042	HARNESS, BIM, CNH 2150 SERIES PLANTERS	492.49
45-09043	HARNESS, HITCH IC18, 12.5' w/BELT & SPINNER & DT-6P ISO CAN	1,352.04
45-09044	HARNESS, TEE, TFM1, CNHi, 12 POS. DT, C-KEY	293.49
45-09045	CABLE, TEE, ISOBUS TFM1, CNHi, 1200 SERIES PLANTER	293.49
45-09050	HARNESS, JUNCTION BOX, BATTERY RING TERMINALS, IBBC	1,457.64
45-09051-MD	CABLE, PLP12, 4 OUTPUT, MINI-DIN, 1.5m/5'	182.44
45-09051-MP	CABLE, PLP12, 4 OUTPUT, 3 POS MP150 TOWER, 1.5m/5'	182.44
45-09051-UX	CABLE, PLP12, 4 OUTPUT, 4 POS. WP, 1.5m/5'	182.44
45-09052-05	CABLE, IC45 PLP CONNECTOR, 5'	174.55
45-09052-10	CABLE, IC45 PLP CONNECTOR, 10'	191.06
45-09052-20	CABLE, IC45 PLP CONNECTOR, 20'	224.09
45-09053-05	CABLE, IC45 SPRAYER, 5'/1.5m, DT/M'N'L/MP150, SPEED 1.6'/0.5m	300.47
45-09053-10	CABLE, IC45 SPRAYER, 10'/3m, DT/M'N'L/MP150, SPEED 1.6'/0.5m	317.54
45-09053-20	CABLE, IC45 SPRAYER, 20'/6m, DT/M'N'L/MP150, SPEED 1.6'/0.5m	351.66
45-09054-05	CABLE, IC45 SPRAYER, 5'/1.5m, WP/MP150/AMP, SPEED 1.6'/0.5m	300.47
45-09054-10	CABLE, IC45 SPRAYER, 10'/3m, WP/MP150/AMP, SPEED 1.6'/0.5m	317.54
45-09054-20	CABLE, IC45 SPRAYER, 20'/6m, WP/MP150/AMP, SPEED 1.6'/0.5m	351.66
45-09055	TERMINATOR, DT 8 POS, PLP, BLK, KEY "B", 902-040	58.66
45-09056	TERMINATOR, DT 8 POS, ISO, GRN, KEY "C", 902-041	58.66
45-09057	SEALING PLUG, DT 8 POS, BRN, KEY "D", 902-042	26.48
45-09058	SEALING PLUG, DT 12 POS, GRY, KEY "A", 902-043	26.48

PART NO.	DESCRIPTION	U.S. DOLLARS
45-09061	CABLE, ISOBUS IN-CAB "Y", 9 POSITION AMP	288.28
45-10007	HARNESS, FLOW CONTROL WILLMAR 8000 SERIES	581.87
45-10050	HARNESS, SPRAYLINK, FOR 10 SECT. CONSOLES	669.57
45-10058	HARNESS, PRODUCT 744	241.71
45-10062	HARNESS TASC DUAL GRAN. RATE SENSOR	357.09
45-10072	HARNESS, 744 CONSOLE, 12'	172.95
45-10073	HARNESS, 744 IMPLEMENT 24' MILLER	356.69
45-10074	CABLE, JUNCTION BLOX, WP, w/DUMP VALVE	1,364.64
45-10080	HARNESS 744 BALL VALVE	389.72
45-10081	HARNESS, 804, 5 BOOM Dj SPEED INPUT	553.92
45-10086	CABLE, EXT. 744A, BALL VALVE, 10 FT. MP280	112.97
45-10101	HARNESS, RELAY INTERFACE, SM5 TO SPRA COUP 3/4K	648.61
45-10103	HARNESS STEERING (A&B)	154.00
45-10106-MD	HARNESS, 5 SECT. BALL VALVES, MINI-DIN,	1,322.24
45-10106-MP	HARNESS, 5 SECT. BALL VALVES, 3 POS MP150 TOWER,	1,322.24
45-10106-OG	HARNESS, 5 SECT. BALL VALVES, 3 POS WP SHROUD,	1,322.24
45-10106-PC	HARNESS, 5 SECT. BALL VALVES, 3 POS WP TOWER,	1,322.24
45-10106-UX	HARNESS, 5 SECT. BALL VALVES, 4 POS. WP SHROUD,	1,322.24
45-10113	HARNESS, 744 BALL VALVE w/3 PIN TWR CPC CONN.	389.72
45-10114	HARNESS, 15' CL250 POWER TO HITCH, IC18	462.35
45-10115	HARNESS, 12.5' IC18 HITCH, BELT, SPINNER	880.15
45-10116	HARNESS, 4' IC18 - EXR IV DUMP VALVE	189.61
45-10121	HARNESS, IC18 TO TEEJET SENSOR	888.17
45-10124	HARNESS IC18 TO MATRIX 570VT	520.11
45-10128	HARNESS, IC18 to SENSORS 5POS WP to NH3	792.14
45-10130	HARNESS IC18 TO RAVEN 8 POS DT TO NH3 SENSORS	840.15
45-10133	HARNESS, 744A-3 REAR 430 DIN 7' MP/WP	681.40
45-10134	HARNESS, 744 5 BOOM, CONSOLE, 13'	800.49
45-10136	HARNESS, FLDPLT VALVE, A, B, & MASTER	222.83
45-10142	HARNESS, BOOM SENSE INTERFACE	398.97
45-10143	HARNESS, IC18 TO VALVES, 4'	184.08
45-10148	HARNESS, SENTRY INTERFACE	506.54
45-10149	HARNESS, TIP FLOW MON. INT., w/RS232 CABLES	524.65
45-10152-MD	HARNESS, 9 SECT. BALL VALVES, w/o PWR, MINI-DIN, 10'	1,544.01
45-10152-MP	HARNESS, 9 SECT. BALL VALVES, w/o PWR, 3 POS MP150 TOWER, 10'	1,544.01
45-10152-OG	HARNESS, 9 SECT. BALL VALVES, w/o PWR, 3 POS WP SHROUD, 10'	1,544.01
45-10152-PC	HARNESS, 9 SECT. BALL VALVES, w/o PWR, 3 POS WP TOWER, 10'	1,544.01
45-10152-UX	HARNESS, 9 SECT. BALL VALVES, w/o PWR, 4 POS. WP SHROUD, 10'	1,544.01
45-10153	HARNESS, BS, SENTRY 6140, HAGIE STS-10, 2006-2009	788.11
45-10154	CABLE, ADAPTER, TJ HARNESS TO RAVEN FLOW CONTROL	521.24
45-10159	HARNESS, BIM, SINGLE BOOM STATUS, WITH SWITCH	263.61
45-10161	HARNESS, BIM, HAGIE STS, 2014/2015	415.88
45-10172	HARNESS, MAIN, FIELDPILOTPRO SCM	348.32
45-10174	HRNS, DRIVER, DJ HF LEFT	607.68
45-10177	HRNS, DJ HF INTERFACE W/PSI	506.54
45-10184	HARNESS, 744 BALL VALVE, METRI-PAK	389.72

COMPREHENSIVE LIST

# COMPREHENSIVE LIST

PART NO.	DESCRIPTION	U.S. DOLLARS	PART NO.	DESCRIPTION	U.S. DOLLARS
45-10185	HARNESS, 744 BALL VALVE WITH MINI-DIN CONNECTORS	389.72	45-20228	CABLE, DIN, CONN. 0.5m 38082-5	74.11
45-10186	HARNESS, BOOM, DYNAJET INTERFACE, 15 SECTION	183.44	45-20229	CABLE, DIN CONN. 1.5m 38082-15	60.04
45-10193	HRNS, DYNAJET INTERFACE, AMPSS 1.5	574.49	45-20232	CABLE, DIN, CONN., 6m 38082-60	79.45
45-10194	HARNESS, ESD, w/WAS CONNECTION	629.92	45-20236	CABLE, SPRAYLINK, SENSOR EXTENSION	72.40
45-10195	HARNESS, BIM, AMPSS 1.5, 15 SECTION	398.97	45-20237	CABLE, MAIN EXT., S5-3 48297-S5-3	685.98
45-10196	HARNESS, 5-SECT. 744, CONSOLE, BALL VALVES, 10'	254.46	45-20238	CABLE, MAIN, S5-10 48297-S5-10	944.04
45-10197	HARNESS, 5-SECT. 744, IMPLEMENT, BALL VALVES, MINI-DIN, 20'	800.49	45-20239	CABLE, JUNCTION BLOX, EXT 48491	520.19
45-10198	HARNESS, 5-SECT. 744, IMPLEMENT, BALL VALVES, METRIPAK, 20'	800.49	45-20240	CABLE, MAIN, EXT. 4 METER 48297-S5-4	722.90
45-10199	HARNESS, 5-SECT. 744, IMPLEMENT, BALL VALVES, 4 POS. WP, 20'	800.49	45-20242	CABLE, MAIN, EXT. 7 METER 48297-S5-7	833.18
45-10200	HARNESS, SINGLE BIM, IC7140, 15 SECTION	528.28	45-20243	HARNESS, CAB, w/PWR ONLY SPRAYLINK	502.47
45-10200-0600	HARNESS, SINGLE BIM, IC7140, 15 SECTION, 6 METERS	542.96	45-20244	CABLE, JUNCTION BLOX, w/3 POS. WEATHERPACK	906.22
45-10206	HARNESS, FIELDPILOT PRO, 3.5M	447.03	45-20254	CABLE, TJ WHEEL SPD/FLOWMETER EXT. 5'	78.67
45-10207	HARNESS, HYBRID, IC7140 ECU, AMPSS 1.5, 4 Pos DT	440.79	473-0003	REED SWITCH ASSY, 17" LEADS	74.11
45-10210	HARNESS, 13 SECTION, BOOM SIGNAL ONLY	720.79	500-0011	SINGLE FLUSH KIT, 1/2"	151.44
45-10214	HARNESS, 908, NAV	656.36	500-0013	DUAL FLUSH KIT, 2 x 1/2" ASSEMBLED	372.32
45-10215	HARNESS, 908, ISO	702.08	500-0052	PACKARD CONNECTOR REPAIR KIT	543.03
45-10226	HARNESS, 908, NAV, POWER & STATUS	206.81	50-01030	HOUSING, 9 POS. DEUTSCH WITH SOCKETS	45.98
45-10230	HARNESS, 908, ISO, W/TEEJET CAN TEE	544.92	50-01040	CONNECTOR, TOWER, 3 POS. SEALED METRIPACK 150.2	12.39
45-10236	HRNS, 908-NAV-TJD-PWP-RS-SS-PO-SP	406.49	50-01069	HOUSING, 3 POS. JST	5.38
45-10240	HRNS, 908-ISO-G-PWP-RS-SS-PO(+12V ONLY)	373.09	50-01070	HOUSING, DEUTSCH, 3 POS. DT, RECEPTACLE	12.39
45-20006	CABLE, POWER BATTERY SIDE 45981	104.23	50-01071	HOUSING, DEUTSCH 3 POS. DT, PLUG	16.04
45-20008	CABLE, END, 15' 21726-15	256.19	50-01079	HOUSING, 28 POS SOCKET PLUG, FRAMATOME	49.59
45-20009	CABLE, POWER 12' 38403-12-COMMAT	167.45	50-01080	CONNECTOR, PRESSURE SENSOR, GDM 2009J	17.74
45-20011	CABLE, EXTENSION, 15' 38404-15	340.37	50-01084	HOUSING, 28 POS PIN RECP. FRAMATONE	33.58
45-20012	CABLE, END, 15' 38405-15	340.37	50-01117	CONNECTOR, HOUSING, 2 POSITION	8.98
45-20017	CABLE, WHEEL SPD EXT. 39035	154.00	50-01138	RECEPTACLE, 9 POS. IN-LINE, DEUTSCH, GRY	45.98
45-20034	CABLE, RAVEN FLOWMETER 39474	319.25	50-01141	TERMINAL BLOCK, 10 POS. 30A, 8-32	56.60
45-20036	CABLE, SENSOR END 844 39495	245.15	50-01169	HOUSING, AMP SEAL 14 POS, BLACK	30.16
45-20040	CABLE, RADAR, 844, 12" 39499	245.15	50-01171	CONN. 7 POS. TOWER 280 MP	17.74
45-20042	CABLE, 844 TO Dj 39512	120.82	50-01172	CONN. 7 POS. SHROUD, 280 MP	17.74
45-20043	CABLE, 844 TO RAVEN 39513	245.15	50-01198	HOUSING, AMP SEAL 35 BLACK	61.77
45-20044	CABLE, 844 TO MICRO 39514	255.82	50-01232	HEADER 34 POS, SMT SX2	19.38
45-20045	CABLE, SENSOR, 1.5M 45925-15	204.61	50-01240	CONNECTOR, A-F 18 POS CINCH	28.41
45-20063	CABLE, COMM., 1.5M 45984-15	220.42	50-01241	CONNECTOR A-K 30 POS. RIGHT SIDE, CINCH	35.44
45-20065	CABLE, DIRECT WIRING 45988	679.69	50-01243	HEADER, 48 POS, SMALL w/o FERRITES	86.48
45-20066	CABLE, DIRECT WIRING 45988-1	628.86	50-01244	ENCLOSURE, SMALL w/o HEAT SINK	56.60
45-20079	CABLE, EXTENSION 21720-15	130.52	50-01245	ENCLOSURE, w/o HEAT SINK FOR IC18	68.79
45-20081	CABLE, 855 TO Dj RADAR 39029	245.15	50-01246	CONNECTOR 60 POLES HEADER w/FERRITES	116.41
45-20087	CABLE, VALVE END 25' 21726-25	144.61	50-01250	DUST COVER AMPHENOL 7 POS	24.83
45-20088	CABLE, END 18' 21725-18	253.85	50-01251	CONNECTOR, CXA 8P 20-24GA CBL-END SM SOLDER CUP	44.23
45-20089	CABLE, END, 15' 21725-15	132.38	50-01253	CONN. MX150 12 POS SKT, 18-22 GA	44.23
45-20090	CABLE, END, 8' 21725-8	74.11	50-01264	CONNECTOR, PRESSURE SENSOR, w/MACROMELT	21.20
45-20091	CABLE, EXTENSION, 8' 21720-8	76.02	50-01278	CONNECTOR 3 POS. DIN	5.35
45-20096	CABLE, END, BATTERY 37208-12	61.77	50-01309	METRIPACK 3 POS. 150.2 P2S TOWER TYPE 101	12.39
45-20097	CABLE, END VALVE 37209-8	45.93	50-05001	PLUG, METRIPACK 150 P2S	1.94
45-20100	CABLE, POWER, 744 21478-2	52.99	50-05007	SEAL, U-CUP, GEAR SENSOR	12.39
45-20104	CABLE EXT. 8', 5 SW. 21721-8	182.13	50-05050	LOCK, DEUTSCH, 3 POS. RECEPTACLE	5.38
45-20105	CABLE, VALV END 8', 5 SW. 21726-8	127.10	50-05051	LOCK, DEUTSCH 3 POS. PLUG	5.38
45-20106	CABLE, EXT. 15', 5 SW 21721-15	215.37	50-05052	STRAIN RELIEF, FRAMTONE, SHELL SIZE 20	31.85
45-20110	CABLE, VALVE END 37209-15	45.93	50-05053	GASKET, GDM SERIES CONNECTOR	5.38
45-20221	CABLE, EXT., 8', F/744A-1 21719-8	104.23	50-05054	SCREW, SS, GDM SERIES CONNECTOR	5.38
45-20226	WIRE, HARNESS, 734 CP36987-COMMAT	135.83	50-05055	STRAIN RELIEF, CABLE RANGE .197-.315	8.98
			50-05063	CAP, DUST, SHELL SIZE 12 FRAMATOME	26.52
			50-05090	BACKSHELL, HD10 SERIES, SIZE 9	14.86
			50-05105	FERRULE, WIRE, 18GA UNINSULATED	1.94
			50-05113	LOCK, SECONDARY 7 POS. 280 MP	5.38
			50-05129	SEAL, 2 POS INTERFACE MATE-N-LOK	1.94



# COMPREHENSIVE LIST

PART NO.	DESCRIPTION	U.S. DOLLARS	PART NO.	DESCRIPTION	U.S. DOLLARS
50-05130	SEAL, 2 POS. WIRE MATE-N-LOK	1.94	54-02030	KIT, PISTON PUMP SEALS VITON	284.95
50-05155	SEAL PLUG FOR HARNESS CONNECTOR, CINCH	1.94	54-02031	KIT, PISTON PUMP VALVES	140.87
50-05163	DUST CAP, 4 POS. WP STKD SHROUD	10.27	54-02044	MIXER CHAMBER, 2" DIA.	347.31
50-05222	DUST CAP, CINCH 18POS	66.20	54-02045	CAP, OIL, PISTON PUMP 3/8", BSP AND SEAL	15.89
50-10007	TERMINAL, FEMALE 16-18 AWG METRIPACK, 150.2 SERIES	1.74	54-02046	PLUG, SEE THRU PUMP 3/4" M BSP AND SEAL	20.07
50-10021	TERMINAL SKT 22-18 GA JST	1.94	54-02052	PISTON, MT600	377.48
50-10024	TERMINAL, SOCKET, 18-16GA FRAMATONE	5.38	57-00001	FLOWMETER, 1 1/4" RPDCHK INSERT 1 1/4" 2.6 - 53gpm	1,351.74
50-10025	TERMINAL, PIN 18-16 GA FRAMATONE	3.66	57-00003	INSERT ONLY, 2.6 - 53 GPM	974.94
50-10026	TERMINAL, PIN, 14GA FRAMATONE	7.27	57-00004	FLOWMETER, R.C. 1 1/4" 2.6-53GPM W/1.5" HOSEBARB	1,448.71
50-10027	TERMINAL, SOCKET, 14GA FRAMATONE	7.27	57-00019	FLOWMETER, R.C., 2.6 -53 GPM NO HOSE BARBS	1,396.73
50-10030	TERMINAL, PIN, 14-18GA, DEUTSCH	1.94	57-00022	FLOWMETER, 1" MID-TECH W/O SENSOR, AS PURCHASED	606.84
50-10045	CONTACT PINS, 22-24AWG	1.94	57-00023	FLOWMETER, 3/4" MID-TECH W/O SENSOR, AS PURCHASED	504.48
50-10079	SKT, AMP 16-20 GA GOLD REEL	3.66	57-00029	FLOWMETER, 1 1/2" MID-TEC W/O SENSOR, AS PURCHASED	892.31
50-10105	TERM. PIN 16-18 GA, GOLD DEUTSCH	1.94	57-00039	FLOWMETER, R.C., 2.6-53 GPM W/1.25" H.B.	1,448.71
50-10106	TERM. SKT 16-18 GA GOLD DEUTSCH	1.94	57-00040	FLOWMETER, SST, 1 1/4" W/ SENSOR, AS PURCHASED	2,243.81
50-10118	CRIMP TERMINAL, CINCH WIRE SIZE 20GXL 18TXL	1.94	57-00051	FLOWMETER, NH3, 1 1/4", 3 POS. DEUTSCH	2,082.32
50-10119	TERMINAL CRIMP FOR CINCH WIRE 18GXL, 16TXL, 16GXL	0.55	57-00065	O-RING, 35mm X 3mm, 801 FLOWMETER	17.03
50-50001	CP38432-COMMAT SKT, CONTACT, 16S, BR-NP	3.66	57-00077	INSERT, FM 801, w/SENSOR	640.84
50-50002	HOUSING, 3 POS., FEMALE SERIES 56	7.27	57-00079	FLOWMETER, 10D, DEUTSCH w/.5m CABLE	437.99
50-50005	HOUSING, 6 POS., CAP STACKED, MATE-N-LOK	3.66	57-00080	FLOWMETER, 16D, DEUTSCH w/.5m CABLE	437.99
50-50006	TERMINAL, PIN 20-14 GA MATE-N-LOK	1.94	57-00081	FLOWMETER, 20D, DEUTSCH w/.5m CABLE	326.40
50-50007	HOUSING, 6 POS. PLUG CP21744-NY	3.66	57-00082	FLOWMETER 26D, DEUTSCH w/.5m CABLE	730.35
50-50008	TERMINAL, SOCKET, 20-14GA CP21755-PHBR	1.94	57-00083	HOSE TAIL, 1/2"	48.51
50-50009	STRAIN RELIEF 6 POS. MATE-N-LOK	7.27	57-00084	FITTING, TJ 50 SERIES FLANGE 16D FLOWMETER	121.44
50-50010	ADAPTER, STRAIN RELIEF MATE-N-LOK	5.38	57-00085	HOSE TAIL, 1" 16D FLOWMETER	56.12
50-50017	HOUSING, 2 POS., PLUG MATE-N-LOK	5.38	57-00086	HOSE TAIL, 3/4" 16D FLOWMETER	56.12
50-50019	HOUSING, 3 POS. PLUG MATE-N-LOK	5.38	57-00087	FITTING, TJ 50 SERIES FLANGE 20D FLOWMETER	120.47
50-50020	TERMINAL, SOCKET, 20-14GA MATE-N-LOK, COMMERCIAL	1.94	57-00088	HOSE TAIL, 1", 20D FLOWMETER	34.19
50-50021	HOUSING, 9 POS., PLUG STACKED, MATE-N-LOK	3.66	57-00090	HOSE TAIL, 1-1/4" 20D FLOWMETER	74.51
50-50022	STRAIN RELIEF, 9 POS. MATE-N-LOK	7.27	57-00092	HOSE TAIL 1-1/2", 26D FLOWMETER	56.12
50-50023	ADAPTER, STRAIN RELIEF, AMP MATE-N-LOK	3.66	57-00093	HOSE TAIL, 1-1/4" 26D FLOWMETER	56.12
50-50024	HOUSING, 9 POS., CAP. STACKED, MATE-N-LOK	3.66	57-00094	FLOWMETER, 40D, DEUTSCH w/.5m	951.93
50-50026	HOUSING, 3 POS., MALE SERIES 56, BLACK	5.38	57-00095	HOSETAILS 2" 40D FLOWMETER	132.88
50-50029	DUST CAP F/RECPT. SIZE 20 COA-UTP20DCG	17.74	57-00096	INSERT FLOWMETER, 26D	475.61
50-50036	CONN., 2 POS CAP AMP CP21760-NY	3.66	57-00097	INSERT FLOWMETER 40D	357.26
51-20004	GAUGE, PRESS. DRY 7 BAR CP26387-7	40.64	57-00105	INSERT FLOWMETER 10D, 16D, 20D	312.48
51-20007	GAUGE, 300 PSI, LIQUID, BULK	86.48	57-00111	SENSOR, FLOWMETER NH3 w/WP CONNECTOR	569.23
51-20008	GAUGE, 100 PSI, LIQUID, BULK	77.77	57-00116	PADDLE WHEEL & SHAFT FOR 10/16/20D FLOWMETER	43.28
51-20015	GAUGE, ISOLATOR	100.65	57-00117	PADDLE WHEEL FOR 26D FLOWMETER	149.92
51-20016	GAUGE, 100PSI(7 BAR) WITH BRKT, REAR-MOUNT FITTING	77.77	57-00118	SHAFT FOR 26D FLOWMETER	7.27
54-01050	PUMP HEAD, 100/150 oz/MIN 3/8" 4" LONG	804.96	57-00120	PADDLE WHEEL FOR 40D FLOWMETER	239.84
54-01052	END BELL, MODIFIED 3/8"	329.58	57-00122	FLOWMETER ASSY., TIP FLOW MONITOR, SNAP-IN	112.31
54-01053	ROTOR ASSY, 3/8" & 1/2" 4" LONG	447.13	57-00123	GASKET, TIP FLOW METER	11.08
54-02000	PUMP ASSEMBLY,	4,861.31	57-00126	O-RING, -219, WHITE VITON801 FLOW METER	17.74
54-02001	LATCH HANDLE ASSEMBLY	206.30	57-00128	TURBINE ASSY, SENTRY 6140 FM, WHITE POLYPROPYLENE	63.36
54-02002	ROTOR ASSY, PUMP	583.56	57-10011	FLOWMETER ASSY	590.77
54-02003	SPRING, TENSION, .6 OD X .85 X 1.5 LONG, #302 SST	12.29	57-10015	FLOWMETER BODY 1/2, 430SS CP38409-1/2-BB	692.97
54-02008	MAGNET ASSY, 1 POLE	70.04	57-10055	FLOWMETER PICKUP 38411-COMMAT	256.85
54-02010	COVER ASSEMBLY, PUMP ENCLOSURE	284.95	57-10057	FLOWMETER, PICKUP, RC 38411-RC-COMMAT	256.85
54-02013	OCCLUSION STRAP ASSY.	206.69	57-10059	FLOWMETER, PICKUP 1/2" 38411-1/2	310.71
54-02020	PUMP HEAD, PISTON #1	1,730.91	57-10068	FLOWMETER ASSY	822.31
54-02021	PUMP HEAD, PISTON #2	1,730.91	57-10080	FLOWMETER, STANDARD 1/2" 38410-1/2-BB	924.54
54-02023	PUMP ASSY, REVERSE PRIME	5,671.87			
54-02026	PUMP PISTON, ASSY w/MANIFOLD, 1 HEAD	4,866.68			

# COMPREHENSIVE LIST

PART NO.	DESCRIPTION	U.S. DOLLARS	PART NO.	DESCRIPTION	U.S. DOLLARS
57-10081	FLOWMETER, 1-1/2" w/BB 38410-1-1/2-BB	969.52	60-06008	PIN, RETAINING, 802 FLOWMETER, 58439-1	11.06
57-10096	F.M. BB,3/4"NYLON STAND 38410-3/4-BB	935.38	60-07011	NUT, NYLOCK, 1/4-28	3.70
57-10097	F.M. 2" NYLON STAND. BB 38410-2-BB	1,385.88	60-07027	NUT, NYLOCK 3/8-16, ZINC-PLATED STEEL	3.66
57-10100	FLOWMETER, 801	694.95	60-07028	NUT WHIZ-LOCK, 5/8"-11 SST	3.50
57-10108	TURBINE ASSEMBLY 801 FLOWMETER	120.21	60-07029	BUSHING 28mm POM	111.26
57-10109	GUIDE VANE BEARING SUPPORT, 801 FLOWMETER	104.88	60-10000	CLAMP, LOOP, 304 SST SILICONE, 3/8" D 1/2" W	10.73
57-10111	WASHER, SEAT, 801 FLOWMETER	13.74	60-10011	HARDWARE PACKAGE 4 WHEEL, SPEED SENSOR	155.26
57-10112	HOSE BARB, 3/4", 50 SERIES, FLANGE	5.49	60-10026	KNOB, 5-LOBE CLAMP 1/4-20 X 1/2" STUD	21.37
57-10113	HOSE BARB, 1", 50 SERIES, FLANGE	5.16	60-10033	PAD, ADHESIVE, FOAM	47.53
57-10114	HOSE BARBS. 1-1/4" 50 SERIES, FLANGE	8.61	60-10042	BEARING, 1/4" ID X 3/8"OD 1/2" LONG, OIL IMP	9.07
57-10115	FLANGE, 1-1/4"NPT (F) 50 SERIES	3.66	60-10048	KNOB, MOUNTING, 10-32 X .5" LONG	14.33
57-10120	HOSE BARBS, 1-1/2" 50 SERIES FLANGE	11.89	60-10051	INSERTS, THREADED, 10-32	7.11
57-10122	FLOWMETER, 802, ASSEMBLY	759.55	60-10053	KIT, HARDWARE, TASC PUMP	37.54
57-10123	GUIDE VANE BEARING SUPPORT, 802 FLOWMETER	104.88	60-10071	LATCH, RUBBER HALF	29.96
57-10124	TURBINE ASSEMBLY, 802 FLOWMETER	120.21	60-10072	LATCH, CATCH METAL HALF	30.19
57-10125	FLOWMETER, 802, w/RAVEN CONNECTOR, 5v-12Vdc OPER.	759.55	60-10081	VELCRO 1" X 3" SET 3M ADHESIVE	8.86
57-10127	FLOWMETER, 801, w/RAVEN CONNECTOR, 5v-12Vdc OPER.	694.95	602-0004	CABLE, SIGNAL 25' W/PINS ISC/TASC	128.35
57-10129	HOSE BARB, 1-1/4",75 SERIES FLANGE	5.77	602-0004-KIT	CABLE, SIGNAL REPLACEMENT KIT ISC/TASC ASSY'S	156.86
57-10133	HOSE BARB, 1-1/2",75 SERIES FLANGE	5.77	602-0008	CABLE,MOLDED IEC 8' 18/3(AgLogix DISPLAY)	24.29
57-10134	HOSE BARB, 2",75 SERIES FLANGE	5.77	602-0013	CABLE, EXT ISC SOL./TASC FLOW CONTROL,12'	181.78
57-10135	FLOWMETER, 802, w/3 POS WP SHROUD	759.55	602-0014	CABLE, EXT 12' SIGNAL/ CHEM FLOW MONITOR	140.87
57-10140	REDUCER COUPLING, 75/50 SERIES FLANGE	14.95	604-0014	FUSE, BLADE 15A	7.11
600-0005	CABLE, POWER 6' PINS CCI PUMP CONSOLE	73.16	604-0030	FUSE, TR-5 5A	15.90
600-0010	MOTOR, 212,195 RPM,12 VDC	1,177.20	60-50000	TOOTHLOCK, 1/4 EXTERNAL CP7695-IZP	1.81
600-0028	MOTOR, MET 12V 1400 RPM	691.06	60-50001	WASHER, FLAT IZP CP21546-IZP	1.94
600-0029	COUPLING, SST 5/16" ID x 1/2" OD x 2" LONG	48.17	60-50003	SCREW,1/4-20X1,RD,HD,IZP CP21547-IZP	1.94
600-0031	SHAFT,SS 5/16" x 20"L	50.05	60-50005	BOLT,HEXHD, 5/16-18X1/2 CP7890-IZP	1.94
600-0041	COUPLING, 1/2 OD x 5/16 x 1/4 ID x 2" L REDUCER SST	91.03	60-50019	NUT, SQUARE, 1/4-20 CP21469-IZP	3.83
600-0059	ROPE,PP BRAIDED YELLOW 1/8"DIAMETER	1.81	60-50020	FACENUT, KNURLED CP21966-NP	3.66
600-0090	SENSOR, SHAFT FOR WHITE HYDRAULIC MOTOR	853.90	60-50026	BLEEDER SCREW, SST	2.73
600-0101	MOTOR, SILICONE SEALED STANDARD 600-0010	1,132.60	64-00057	PANEL, FRONT FOR 844AB	63.67
60-01001	WASHER, FLAT, .675" x .9" x .017", TEFLON	12.39	64-03001	ENCLOSURE, POLYETHYLENE WEATHERGUARD	167.66
60-01005	WASHER, FELT, .75" ID x 1.12" OD x 0.12" THK	7.27	64-03050	RUBBER PROTECTOR CENTERLINE 220	26.11
60-01033	WASHER, FLAT, M8, ZINC	1.64	64-03058	SPACER PLAT, GPS SUPER STAR II	5.38
60-02000	NUT, NYLOCK #8 ZINC PLATED STEEL	12.39	64-05066	CUP, SUCTION MOUNT LIGHTBAR/CONSOLE	146.64
60-04022	SCREW SHT MTL., #8 x 1" SST, PH., BLACK FINISH	1.94	64-05070	SUPPORT, BLOCK BEARING	114.13
60-04023	SCREW SHT MTL., #4 X 3/8" PH, BLACK	7.27	64-05071	GASKET, QUICK DISCONNECT VITON	3.66
60-04027	SCREW SHOULDER, 3/16" 4-40 THREAD X 1/4" LG	14.33	64-05076	LATCH, HANDLE, PUMP	87.26
60-04031	SCREW,SHEET MTL, #4 x 5/8", F.H., PH, 18-8 SST	7.27	64-05084	SIDE PLATE, 844E, RIGHT SIDE w/CONNECTORS	507.81
60-04046	SCREW SHT MTL., #2 x 1/4" P.H., PHILLIPS	3.66	64-05088	PANEL, FRONT, 854 w/OVERLAY	296.37
60-04048	SCREW PLASTITE 4-20 X 3/8 P.H., TORX, STEEL/ ZINC	1.94	64-05091	ADAPTER, MOTOR, BALL VALVES	2.60
60-04052	BOLT, GRIPPER, 1/4"	5.44	64-05092	MANIFOLD FOR 2-HEAD PISTON PUMP	219.16
60-04064	SCREW PLASTITE, #6 X 3/8" ZINC, PH	10.73	64-05093	MANIFOLD, FOR 3-HEAD PISTON PUMP	265.54
60-04075	SCREW #4-20 X 1" L PLASTITE TORX, SST	5.38	64-05095	BELT, TIMING, 18.75"	37.54
60-04076	SCREW, #10 X 1" L SST PH, PHILLIPS, SHT METAL	5.38	64-05100	SEAL, TEFLON	197.82
60-04077	SCREW PLASTITE, #6 X 5/8" S.S. P.H.	5.44	64-05105	FITTING BLOCK, QD TO 3/4" FPT, MT 500 PUMP	23.35
60-04089	BOLT, HEX 3/8-16 x 3-3/4" SST	15.90	64-05108	PLUG HOLE 11/16 BLACK	5.38
60-04093	BOLT HEX 5/8"-11 X 4.5" SST	35.44	64-05112	CUP, SUCTION MOUNT w/TWIST LOCK	86.39
60-04124	SET SCREW 1/4-20 X 3/4" ALLOY PATCH FLAT PT	5.38	64-05136	DUSTCAP MATRIX 570G & 840G 3 CONN MOLDED RUBBER	17.72
60-04131	SCREW SOCKET HEAD CAP 10-24 X 1.5" SST	2.81	64-05137	GASKET, LOWER HOUSING RIGHT SIDE	5.38
60-04162	SCREW, MACHINE PH, PH #2-56 x 3/8", w/ISP, ZINC	0.79	64-05138	GASKET, LOWER HOUSING LEFT SIDE	5.38
60-05015	SPACER, OCCLUSION	28.41	64-05181	CUP, SUCTION MOUNT 4.5" DIA, w/1/4-20 INSERT	146.64
60-06001	SPRING, PIN, 2mm X 16mm TYP 18-8 SST	5.38	64-05201	SPACER, SOM, iMX 51	1.96
60-06003	PIN D SERIES, INSERT 10/16/20D FLOWMETERS	14.33	64-50003	O-RING, VITON CP7717-2/125-VI	1.94
60-06004	PIN, D SERIES HOSETAIL 10/16/20 D FLOWMETERS	14.33	64-50005	O-RING, M26 X 3", VITON CP7717-M26X3	1.94
			64-50011	BRACKET, LEFT SIDE F/844 39343-NYB	14.33
			64-50012	GASKET, LEFT SIDE, F/844 39437-L	10.73

# COMPREHENSIVE LIST

PART NO.	DESCRIPTION	U.S. DOLLARS	PART NO.	DESCRIPTION	U.S. DOLLARS
64-50014	WHEEL, MAGNET ASSY 38416	53.95	65-05251	BRACKET, SCM PRO, FLAT	231.87
64-50023	BRACKET, MOUNTING CP36990-NYB	31.85	65-05260	RAM DBL SKT ARM, FOR 1.5" BALL, LONG, RAM-201U-D	81.05
64-50024	HOUSING, FRONT, 744A CP21969-PHO	26.52	65-10023	HOUSING, SSCO, 228mm, CONSOLE, 10 BOOM	60.08
64-50025	HOUSING, BACK, 744A CP21462-PHO	26.52	65-10026	EXTRUSION SMALL, 11" BLACK WRINKLE	66.03
64-50026	RECEPTACLE, POWER CP21487-NEO	7.27	65-10027	EXTRUSION, SMALL 7.25" BLACK WRINKLE	52.88
64-50030	SPCR, FOAM, NEO 744A LIQ CP37216-2 NEO	10.73	65-30019	WIREFORM, LATCH	74.11
64-50031	GAUGE, LENS, 2 1/2" CP21972-PLST	14.33	65-30022	CATCH, WIREFORM	14.33
64-50032	SHIELD, CBL OUTPT F/744-3 CP21488-NEO	7.27	65-30023	BRACKET, VALVE MOUNT	98.13
64-50044	BODY, 801 FLOWMETER	62.68	65-30050	PIN, LOCKING, WIDE B-MOTOR, HYDRAULICS	14.33
64-50045	ENDCAP, 801 FLOWMETER	37.32	65-30055	LOCK, PIN, RETAINING CLIP	3.25
64-50046	RETAINING NUT, 801 FLOWMETER	38.97	65-30060	COUPLER, SST B-STYLE MTR TO 3/8" BRASS VALVE	111.93
64-50047	INSERT, BODY, 801 FLOWMETER	38.97	65-50004	BRCKT MOUNT CONSOLE ASSY 38528	61.04
64-50054	BODY, 430 FLOWMETER	21.07	67-00004	COUPLER, Dj 360 SLOT RATE SENSOR	160.60
64-50065	BODY, 802 FLOWMETER	65.37	67-00018	FITTING, 1/2M, SST BSP	69.53
64-50071	BODY, FINISHED, 3/4" NPT	23.13	67-01012	FITTING, QUICK CAP, BLUE HOSEBARB, QUICK DISCONNECT	10.73
64-90007	O-RING, ID 1-5/8 X OD 1-7/8	24.83	67-01025	FITTING, PLUG 3/4" NPT NYLON	10.82
64-90019	KIT, O-RING, EXR-II SERVICE	54.71	67-01033	FITTING, 1/4" NPT NIPPLE SHORT POLY	6.07
64-90022	O-RING, 10D, 16D, 20D, SENSOR	5.38	67-20000	ELBOW, GAUGE, CONNECTOR CP36986-NYB	16.04
64-90023	O-RING, 10D, 16D, 20D, SIDE INLET	5.38	67-20001	COUPLING, MALE, NYLON CP21486-NY	1.94
64-90024	O-RING, 26D, SENSOR AND SIDE INLET	8.98	67-20002	NUT, TUBING, NYLON CP21545-NY	1.94
64-90025	O-RING, 40D, SENSOR	10.73	67-20003	CONNECTOR, MALE, NYLON CP21736-NY	4.51
64-90026	O-RING, 40D, SIDE INLET	10.73	67-20004	FITTING, TEE w/GAUGE CP21476-NYB	12.39
64-90027	O-RING, #028 VITON 0.070" WALL X 1.364" ID	5.44	67-20005	NIPPLE, 3/4" CLOSE NYLON CP21737-NYB	6.07
64-90028	O-RING, #014 VITON 0.070" WALL X 0.489 ID	5.44	68-02192	ADAPTER, HYD. #12MJIC x M26 x 1.5 FEMALE x 18mm TUBE	52.21
64-90052	O-RING, 1/8" DIA. x 1.75" ID x 2" OD, VITON	17.03	70-04008	TUBE ASSY, QD, 3/16" PYTHON	66.05
65-00023	PANEL, FRONT, 844	208.21	70-04009	TUBE ASSY, QD, 1/4" PYTHON	66.05
65-00036	PANEL, END SMALL EXT. 3/4" HOLE BLACK	30.16	70-04010	TUBE ASSY, QD, 3/8" PYTHON	66.05
65-00054	HOUSING, HYD. SWITCHBOX 228MM	45.93	70-04011	TUBE ASSY, QD, 1/2" PYTHON	66.05
65-00055	HOUSING HDY. SWITCHBOX 187MM	38.91	70-04012	TUBE ASSY, QD 5/8" PYTHON	60.64
65-00060	PANEL, FRONT, JD AUTO CONTROLLER	153.53	70-04013	TUBE KIT, QD PYTHON, 3/16, 1/4, 3/8, & 1/2	249.93
65-05019	PLATE, WHEEL ASSY, SPEED SENSOR KIT	761.66	70-04015	TUBE, PYTHON, 5/8", ID	37.54
65-05037	BRACKET, UNIVERSAL SENSOR GRAN. BIN MOTOR	112.97	70-04017	TUBE ASSY., QD 3/16" VITON	80.47
65-05045	GEAR, SPROCKET, 1/2" BORE 9 TOOTH, PAINTED	115.67	70-04018	TUBE ASSY., QD 1/4" VITON	104.96
65-05050	BRACKET, RAM-101u	134.14	70-04019	TUBE ASSY., QD 3/8" VITON	202.73
65-05052	BRACKET, CENTERLINE LIGHTBAR	45.39	70-04022	TUBE ASSY., QD 3/16" ED-PLEX	52.49
65-05057	BRACKET, TB PUMP DRIVERS TASC SERVICE	56.60	70-04023	TUBE ASSY., QD 1/4" ED-PLEX	50.77
65-05065	RAM, U-BRACKET 3/4" - 1" w/ 1.5" BALL	144.61	70-04024	TUBE ASSY., QD 3/8" ED-PLEX	54.21
65-05095	BRACKET, PUMP COVER, LEGACY	64.30	70-04025	TUBE ASSY., QD 1/2" ED-PLEX	50.77
65-05125	RAM MOUNT, RAM-B-238U CENTERLINE 220	30.32	703-0000	PLUG, DEUTSCH HD10 DRC	7.27
65-05126	BASE, 2.5" DIA w/1" BALL	36.83	703-0020	SKT, DEUTSCH, 16-20 GA	10.73
65-05128	ARM, DOUBLE SOCKET, 3"L	43.33	70-50000	TUBING, NYLON, 1/8" OD X .031 WALL, BLACK	3.66
65-05129	KIT, BASE CL 220, w/1" BALL	41.00	70-50004	TUBING, 1/8" OD X .031" NYL CP21634-17-NYB	35.44
65-05133	BRACKET, HYD. BLOCK MOUNT AC854	134.87	70-50005	TUBING, 1/8" OD X .031" NYL CP21634-25-NYB	54.71
65-05134	BRACKET, HYD. BLOCK MOUNT AP*, CMX*, JD*, WM*	111.12	70-50007	TUBING, 1/8" OD X .031 NYL CP26134-27-NYB	61.77
65-05164	BRACKET HYD. BLOCK MNT CASE 8900	136.18	70-50008	TUBING, 1/8" OD X .031" NYL CP21634-10-NYB	28.41
65-05178	BRACKET, MT500 MOTOR SENSOR	24.83	70-50009	TUBING 1/8" OD X .031" NYL CP21634-20-NYB	47.64
65-05179	PLATE, MOUNTING FOR PATCH ANTENNA	15.19	706-1001	TOWER, METPK 150 2 POS	8.98
65-05181	PLATE, RIGHT SIDE LOWER HOUSING	10.73	706-1002	SHROUD, METPK 150 2 POS	5.38
65-05182	PLATE, LEFT SIDE, LOWER HOUSING	14.33	706-1003	TOWER, METPK 150 6 POS	16.04
65-05185	MOUNT, RAM, CAMERA	75.46	706-1004	SHROUD, METPK 150 6 POS	5.38
65-05226	BRACKET KIT, RXA-30 ANTENNA	204.54	706-1102	TERMINAL, PIN 16-18ga MET PK 150	1.94
65-05230	RAM, 2-1/2" DIA BASE w/ 1.5" BALL	33.65	706-1202	TERMINAL, SKT 16-18ga MET PK 150	1.94
65-05241	RAM-MOUNT RAP-B-166-2U	42.47	706-1300	PLUG, DK RED METPK	1.94
65-05243	BRACKET, MOUNTING, RX520/RX720	168.39	706-1304	SEAL, 18ga RED METPK 150	1.94
65-05244	RAM BASE 1" X 2" W/ 1.5" BALL	53.84	706-1401	LOCK SECONDARY, 2 POS METPK 150	1.94
65-05245	RAM DBL SOCKET ARM, SHORT, FOR 1.5" BALL	43.52	706-1402	LOCK SECONDARY, 6 POS METPK 150	1.94
65-05246	KIT, UNIVERSAL ANTI-ROTATION BRKT	296.44			
65-05250	ASSY., ANTI-ROTATION PINUNIPLOT PRO	51.93			

# COMPREHENSIVE LIST

PART NO.	DESCRIPTION	U.S. DOLLARS	PART NO.	DESCRIPTION	U.S. DOLLARS
706-3001	TOWER, METPK 480 2 POS	12.39	75-30016	CONSOLE, SPEED AREA, METRIC	708.38
706-3002	SHROUD, MTRIPK 480 2 POS	10.73	75-30018	CONSOLE, FILL FLOW METRIC	708.38
706-3103	TERMINAL PIN 12 GA METPK 480 SERIES	7.27	75-30019	CONSOLE, FLOW VOLUME METRIC	708.38
706-3104	TERMINAL PIN 10 GA METPK 480 SERIES	7.27	75-30020	CONSOLE, DUAL RPM, 70 SERIES	708.38
706-3204	TERMINAL, SKT 10-12ga MET RPK 480	7.27	75-30025	CONSOLE SPEED/PRESSURE AREA 70 SERIES	708.38
706-3303	SEAL, 14ga RED METRPK 480	7.27	75-30100	CONSOLE, SENTRY 6140 TIP FLOW MONITOR	974.36
706-3305	SEAL, 10-12ga ORN METRPK 480	7.27	75-30118	CONSOLE, SENTRY 6120 DROPLET SIZE MONITOR	1,054.90
706-3401	LOCK SECONDARY, 2 POS. MTRIPK 480	7.27	75-30119	CONSOLE, DYNAJET FLEX 7120	947.76
707-0035	TOWER, 3 POSITION IN LINE WEATHERPACK	7.27	75-50033	HOUSING,CTRL,100L-3,37203-100L-3	400.39
707-0036	SHROUD, 3 POS IN LINE WEATHERPACK	5.38	75-50035	HOUSING, CTRL, 300L-3 37203-300L-3	484.92
707-0037	TERMINAL, PIN 18-20 GA WEATHERPACK	5.36	75-50048	CONSOLE, 834-P	882.50
707-0038	TERMINAL, SOCKET 18-20 GA WEATHERPACK	5.38	75-50060	SWITCHBOX 744E-3	504.31
707-0039	TERMINAL, PIN 14-16 GA WEATHERPACK	5.36	75-50061	SWITCHBOX, 744E-5	578.64
707-0040	TERMINAL, SOCKET 14-16 GA WEATHERPACK	5.38	75-50064	CONSOLE, RADION 8140-5	3,314.55
707-0041	SEAL, GREEN 18-20 GA WEATHERPACK	5.38	75-50065	CONSOLE, RADION 8140-7	3,497.37
707-0042	PLUG, GREEN WEATHERPACK	5.38	75-50066	CONSOLE, RADION 8140-9	3,681.85
707-0043	RETAINER, O-RING	5.38	75-50068	SWITCHBOX 744E-3, 300 PSI GAUGE	504.31
707-0044	SEAL, RED 22-24 GA WEATHERPACK	5.38	75-50069	SWITCHBOX 744E-5, 300 PSI GAUGE	578.64
707-0045	SEAL, GREY 14-16 GA WEATHERPACK	5.38	75-50072	CONSOLE, 5 SWITCH, 845	1,538.53
707-0048	SHROUD, WTHRPK 1 POS	5.38	75-50075	CONSOLE, 845-AB, 4 SECTIONS, COMM., SPEED	2,103.87
707-0049	TOWER, WTHRPK 1 POS	7.27	76-00488	CABLE, ADAPTER, USB PROGRAMMING	95.79
707-0050	SHROUD, WTHRPK 6 POS	7.27	78-00027	SWITCHBOX, IGNITION SENSE	226.22
707-0051	TOWER, WTHRPK 6 POS	12.39	78-00028	SWITCHBOX SWATH MANAGER ENGAGE	227.63
707-0052	SHROUD, WTHRPK 4 POS STKD	7.27	78-00030	SWITCHBOX, ON-OFF, 2 POS WP	211.35
707-0053	TOWER, WTHRPK 4 POS STKD	7.27	78-00043	SWITCHBOX, STATUS DETECT DEMO	161.77
707-0054	SHROUD, WTHRPK 2 POS	5.38	78-00045	SWITCHBOX 5 BOOM REPLACEMENT FOR 405-0073	752.96
707-0055	TOWER, WTHRPK 2 POS	7.27	78-00052	SWITCHBOX, 9 BOOM ISO	957.73
707-0056	SHROUD, WTHRPK 4 POS IL	5.38	78-00055	SWITCHBOX, 9 BOOM ISO, NO REMOTE MASTER	947.83
707-0057	TOWER, WTHRPK 4 POS IN LINE	7.27	78-05003	INTERFACE CABLE, FLOWMETER, 5' DIVIDE BY 4	486.65
707-0103	FUSEHOLDER, BLADE-TYPE IN-LINE	7.27	78-05012	INTERFACE, ASSY, "C" CHANNEL DIVIDE BY 4	296.37
707-0104	CAP, FUSE HOLDER BLADE STYLE	5.38	78-05016	INTERFACE, CABLE, SPEED SENSOR	421.53
707-0105	TERMINAL, FEMALE 12ga FUS HOLDER	5.38	78-05030	DRIVER, 30 AMP GRAN.BIN	1,703.05
707-0106	TERMINAL, FUSE HLDR 14-16 GA FEMALE	5.38	78-05036	INTERFACE, FLOWMETER, RAVEN-SPX, 32"	231.06
708-0010	CONNECTOR, AMP 4 PIN	16.04	78-05037	INTERFACE, VALVE DRIVER, 2 WIRE	507.81
709-0001	CONNECTOR, AMP 14 PIN	19.46	78-05066	INTERFACE DIVIDE BY 4, MIRUSSO FLOWMETER	511.41
709-0002	CONNECTOR, AMP 14 SKT	19.46	78-05068	GPS SPEED SENSOR ASSY	627.21
709-0007	CONNECTOR, AMP 4 SOCKET	12.39	78-05070	GPS SPEED SENSOR w/3 POS CXA	538.54
710-0001	TERMINAL, AMP PIN 14-18ga	12.39	78-05071	GPS SPEED SENSOR w/3 POS DT	538.54
711-0001	TERMINAL, AMP SKT 14-18ga	12.39	78-05072	SECTION DRIVER MODULE	1,575.23
712-0038	CONNECTOR, PNL MNT 8SG SOLDER CUP	26.52	78-05075	SDM, REVERSE LOGIC SOFTWARE	1,575.23
713-0003	TUBE, JUNCTION 2"ID x 4"L	12.39	78-05077	SECTION DRIVER MODULE DM SOFTWARE	1,575.23
713-0005	TUBE, JUNCTION 1.625" IDx 3.75"L	5.38	78-05079	PROTOTYPE, INTERFACE DIVIDE BY 4,	510.99
75-01006	CONSOLE, ARC 6000, CE SFTWR. 2.03	2,683.20	78-05091	BOOM INTERFACE MODULE	469.94
75-01016	CONSOLE, ARC-6000 CE, JD TURF, SFTWR 6.01	2,681.45	78-05097	PRESSURE TO CAN INTERFACE	521.84
75-02013	CONSOLE, TASC 6100 CE 1.30 MAST. 2.31 FAN SLAVE	4,325.03	78-05098	SECTION DRIVER MODULE, SECTIONS 1-15, NO TERMINATOR	1,589.64
75-02014	CONSOLE, TASC 6500 CE SFTWR M-2.62,L-SLAVE 2.35	6,883.99	78-05101	INTERFACE, TIP FLOW MONITOR	728.85
75-02015	CONSOLE, TASC 6300 CE SFTWR, M-3.23, SLAVE 3.05	5,931.51	78-05104	INTERFACE, TIP SENSOR, 3' w/ OVERMOLDED SENSOR	276.24
75-02016	CONSOLE, TASC 6600 CE SFTWR, M-3.23, SLAVE 3.05	7,193.29	78-05105	INTERFACE, DUAL TIP SENSOR, w/ OVERMOLDED SENSORS	363.92
75-02017	CONSOLE, TASC 6200 CE SFTWR, M-2.62, SLAVE 2.35	5,719.04	78-05106	INTERFACE, DYNAJET LT	714.59
75-30005	SMARTPAD II, HANDHELD DISPLAY	4,426.28	78-05110	INTERFACE, PRESSURE TO SENSOR, CAN	356.42
75-30008	CONSOLE, AIRMATIC TEEJET	5,377.76	78-05111	DRIVER, DYNAJET LT	825.89
75-30012	CONSOLE, FILL FLOW	708.38	78-05112	INTERFACE, CAN REVERSE SENSE	540.27
75-30013	CONSOLE, FLOW VOLUME	708.38	78-05114	WIRELESS ADAPTER, SENTRY, B.T.	419.46
75-30015	CONSOLE, RPM MONITOR	708.38	78-05117	INTERFACE, TIP SENSOR, 3'w/ 50" OVERMOLDED SENSOR, SW 1.04	357.79



# COMPREHENSIVE LIST

PART NO.	DESCRIPTION	U.S. DOLLARS
78-05118	INTERFACE, DUAL TIP SENSOR, w/ 50" OVERMOLDED SENSORS	436.09
78-05119	INTERFACE, ISOBUS TIP FLOWMONITOR	983.89
78-05121-03	POWER DISTRIBUTION MODULE,2 POS DT, 3 - 4 POS DTP	526.89
78-05121-04	POWER DISTRIBUTION MODULE,2 POS DT, 4 - 4 POS DTP	611.14
78-05121-05	POWER DISTRIBUTION MODULE, 2 POS DT, 5 - 4 POS DTP	695.39
78-05121-06	POWER DISTRIBUTION MODULE, 2 POS DT, 6 - 4 POS DTP	795.56
78-05122	DRIVER, DYNAJET FLEX,W/ 4 POS DTP PWR IN	825.89
78-05123	DYNAJET HIGH FLOW INTERFACE MODULE	714.59
78-05124	DYNAJET HIGH FLOW DRIVER	1,635.54
78-05127	INTERFACE, SDM, TEEJET	2,560.29
78-05130	LOAD CELL INTERFACE, 4 POSITION	783.63
78-05132	LOAD CELL INTERFACE, 6 POSITION	910.48
78-05137	IC7140 PRESSURE TO CAN INTERFACE	352.20
78-08012	MODULE, BOOSTER 25A	427.75
78-08016	MODULE, PSM, w/L6K	1,024.31
78-08019	PUMP CONTROL ASSY	616.11
78-08020	MODULE, REVERSE PRIME PUMP	354.40
78-08023	PUMP CONTROL ASSY, TASC PUMP	952.13
78-08024	DRIVER, 30A, SERVICE, TASC PUMP	1,155.84
78-08025	DCM, DUAL CONTROL MODULE	1,639.21
78-08046	PUMP CONTROL ASSY PISTON PUMP	521.95
78-08047	SFM 1-10 w/SENSE & MASTER	3,051.93
78-08050	DUAL CONTROL MODULE, RMS	1,639.21
78-08061	STEERING CONTROL MODULE, FPIV	4,051.99
78-08067	MODULE 4CH VIDEO CAN	879.00
78-08072	INTERFACE FIELDPILOT, CONSTANT VOLTAGE	247.26
78-08075	STEERING CONTROL MODULE, PRO	4,051.99
78-08079	DCM FOR AEROS	1,552.70
78-08089	SIMULATOR, TEEJET, RADION/MATRIX	938.65
78-08095	SCM PRO w/HYDRAULIC +RTK UNLOCKED	10,811.50
78-08096	SCM PRO w/UNIPLOT PRO UNLOCKED	5,476.17
78-08097	SCM PRO w/UNIPLOT PRO ONLY TEEJET	5,476.15
78-08098	SCM PRO w/ HYDRAULIC TEEJET	7,995.64
78-08101	SCM PRO w/ STEER READY TEEJET	6,513.60
78-08116	MODULE, IC38, SINGLE CHAIN, BELT SERVO & PWM, LEFT/RIGHT PWM SPINNER	5,068.12
78-08117	MODULE, IC38 SPREADER, TWO CHAIN, TWO SECTION	5,592.30
78-10002	JUNCTION BOX w/2 ROWS OF JST CONN., AIRMATIC	886.78
78-30004	SWITCHBOX BOOMS 1-10 NEW CAN TEE	791.55
78-30005	SWITCHBOX BOOMS 11-20 NEW CAN TEE	770.44
78-30008	SWITCHBOX PROD 1-4 NEW CAN TEE	650.30
78-30009	SWITCHBOX BOOM 1-5 NEW CAN TEE	650.30
78-30010	SWITCHBOX CAN 1-12 ROW TEEJET TECHNOLOGIES	947.89
78-30011	SWITCHBOX, 6 SECTION	1,112.19
78-30012	SWITCHBOX, 9 SECTION ISOBUS	1,176.19
78-50059	CARD, SRAM, LEGACY 2000	684.63
78-50069	ADAPTER, THREADED, ANTENNA	58.19
78-50070	BASE, ANTENNA MAGENTIC MOUNT	101.24
78-50102	MOUNT, MAGNETIC, RX360P	146.43
78-50106	POWER SUPPLY , CENTERLINE DISPLAY	228.55
78-50113	MOUNT, MAGNETIC, RX350p	58.25
78-50137	CARD, FLASH COMPACT 256MB	226.22
78-50138	CARD, FLASH COMPACT 256 MB, AS SHIPPED	222.02

PART NO.	DESCRIPTION	U.S. DOLLARS
78-50158	COMPACT FLASH CARD ADAPTER	65.37
78-50179	MOUNT, MAGNETIC CAMERA	75.46
78-50189	ANTENNA, WI-FI	31.54
78-50190	ANTENNA, PATCH, GLONASS	312.99
78-50201	SIMULATOR, PRESSURE SENSOR, 3 POS. WP	205.38
78-50203	RECEIVER, GPS RX375P SBAS	2,140.56
796-0001	MAGNET ASSY, 2 POLE .375"	60.04
796-0002	MAGNET, CALIBRATION	16.04
796-0005	MAGNET, 60/pk UNIV WHEEL SENSOR	102.32
796-0006	MAGNET ASSY, 2 POLE x .5" ID	60.04
796-0011	MAGNET ASSEMBLY,3 POLE x.500" I.D.	60.04
815-0009	BRACKET, CONSOLE MOUNT TASC/ARC CONSOLES	52.99
815-0030	BRACKET,MOUNTING,UNIVER- SAL MOTOR DRIVER MODULE	24.83
822-0001	NIPPLE,REDUCING PP 3/4" x 1/2"	10.73
824-0305	ELBOW, 90D PP 1/2" MPT x 1/2" HB	14.33
824-0405	NUT, SWIVEL, 11/16",PP	14.33
824-0406	BARB, HOSE 1/2" PP WITH FLANGE	14.33
824-0411	BARB,HOSE PP 1/4"W/FLANGE	14.33
824-0502	ELBOW, STREET 90D PP 3/4"	17.74
825-0505	PLUG, HEXHEAD PP 1/4"	14.33
830-0001	WELL NUT, .25 x 20 x .625	17.74
835-0001	FITTING, BLKHD 3/4"	28.41
835-0002	FITTING BULKHEAD 1/2"POLY	23.09
84-01017	LABEL, CONSOLE/FLAG	3.56
84-01052	DECAL, FOR 844AB	118.12
84-02013	DECAL, TASC 6100	57.78
84-02026	DECAL, TASC 6300 CE VERSION	43.79
84-02060	DECAL, OVERLAY, LIGHTBAR TeeJet	47.62
84-02066	DECAL, CENTERLINE, TEEJET	31.49
84-02072	DECAL, TEEJET 844-E	37.04
84-02103	DECAL, 854 CONSOLE	81.20
84-02104	DECAL, VISAFLO 844/854	22.94
84-02141	DECAL, 570G TEEJET TECHNOLOGIES LOGO	4.70
84-20002	PANEL, GRAPHIC, 3 CP37213-PC	15.90
845-0001	CLAMP,HOSE,BLACK NYLON, .411-.460 DIA,SNP 4	10.73
845-0002	CLAMP HOSE DIA .500 - 580 SNAP 10	14.33
845-0003	CLAMP,HOSE,PLASTIC, .579-.662 DIA.	14.33
849-0205	COVER PLATE, 610 PUMPHEAD	163.97
851-0010	KNOB, CONSOLE MOUNTING	16.04
851-0015	KNOB, DISPLAY ISC/TASC	34.73
851-0017	SWITCH SEAL, GREY SILICON 1/4" THREADS	23.09
851-0022	SWITCH BOOT, RED PUSH BUTTON FASSE	19.46
852-0002	NUT, THUMB, 10-24 x .5" CCI COVER	38.83
852-0004	SWITCH, SPST 20A LIGHTED	50.13
852-0007	SWITCH, SPDT ON-OFF-ON LG TGL	24.83
853-0002	SWITCH, DPDT (ON)OFF(O) LG TGL SCREW TERM	45.93
853-0003	SWITCH, SPST 15A 12VDC	23.09
853-0015	SWITCH, SPST #8 SCREWS	127.16
853-0016	SWITCH, SPST ON-OFF LG TGL LONG BAT	54.71
853-0018	SWITCH, PUSH SPDT	54.71
853-0020	SWITCH, SPDT ON-ON MINI FLAT BAT	37.19
853-0021	SWITCH, SPDT (ON)OFF(O) FLAT, PC	37.19
853-0022	SWITCH, DPDT ON-ON MINI PC FLAT BAT	40.64
853-0028	SWITCH, SPDT (ON)OFF(O) MINI w/LG BAT	54.71
853-0030	SWITCH, PUSH BTN SPDT PUSH-ON PUSH-OFF SDR TERM	54.71
853-0034	SWITCH, MASTER ON-OFF CCI CONSOLES	47.64

# COMPREHENSIVE LIST

PART NO.	DESCRIPTION	U.S. DOLLARS	PART NO.	DESCRIPTION	U.S. DOLLARS
853-0037	SWITCH, SP12T ROTARY NO STOP TASC/ARC CONSOLES	130.52	90-02255	KIT, SPEED AREA	863.08
853-0042	SWITCH, SPDT ON-OFF-ON PC MNT LG BAT	28.41	90-02259	KIT, FILL FLOW, 16D F.M. 71 SERIES MONITOR	1,336.64
877-0012	STRAIN RELIEF SMALL	16.04	90-02279	KIT, TEEJET SIMULATOR	1,145.46
877-0015	STRAIN RELIEF EXTRA LARGE W/.703 DIA. CABLE EXIT	19.46	90-02280	KIT, LOGIC ELEMET, REPLACEMENT FOR 35-03004	155.26
877-0020	STRAIN RELIEF, WATERPROOF .231 - .394	12.39	90-02289	KIT, SEAL FOR BRAND VALVE	38.91
877-0021	STRAIN RELIEF, WATERPROOF .270 - .480	10.73	90-02301	KIT, FILL FLOW, 40D F.M. 71 SERIES MONITOR	1,824.23
877-0030	GROMMET, .185 ID x .3125 RUBBER	12.39	90-02302	KIT, FILL FLOW 10D F.M. 71 SERIES MONITOR	1,336.95
877-0031	WASHER, FLAT, 3/8", VITON 5/8" OD x .062 THK	14.33	90-02303	KIT, FLOW VOLUME, w/o FLOWMETER	831.45
877-0032	O-RING, CPC CONN STD	5.38	90-02308	KIT, FLOWMETER 10D, 1/2" HOSE BARBS	522.53
877-0038	SEAL, 5/16" SHAFT	35.44	90-02309	KIT, FLOWMETER 16D 3/4" HOSE BARBS	522.53
878-0002	DUST CAP, AMP CPC	26.52	90-02310	KIT, FLOWMETER 16D 1" HOSE BARBS	522.53
878-0006	DUST CAP, CXL MULTI CON PNL MNT	10.73	90-02311	KIT, FLOWMETER 20D 3/4' HOSE BARBS	410.95
879-0002	VALVE, AUTORANGE, 3/4" SST,#50 WIRING,1.5 SECOND	1,643.15	90-02312	KIT, FLOWMETER 20D 1' HOSE BARBS	382.10
879-0003	VALVE, AUTORANGE, 1" SST #50 WIRING, 1.5 SECOND	1,707.43	90-02314	KIT, FLOWMETER 26D 1-1/4" HOSE BARBS	814.91
879-0004	VALVE, AUTORANGE, 1-1/2" SST, #50 WIRING, 3 SEC.	2,530.69	90-02315	KIT, FLOWMETER 26D 1-1/2" HOSE BARBS	814.91
879-0101	POWERHEAD, #50 WIRING,1.5 SECOND, W/ PACKARD CONN.	662.81	90-02316	KIT, FLOWMETER 40D 2" HOSE BARBS	1,071.87
879-0104	POWERHEAD, #50 WIRING 3 SEC.	662.81	90-02320	KIT, SPEED AREA, METRIC	863.08
879-1071	REPAIR KIT, VALVE, 1" AUTORANGE, PP	82.92	90-02321	KIT, FILL FLOW, 16D F.M. METRIC, 71 SERIES MONITOR	1,335.91
879-1072	REPAIR KIT, VALVE, 1-1/2" AUTORANGE, PP	109.98	90-02323	KIT, FILL FLOW, 801 F.M. METRIC, 71 SERIES MONITOR	1,668.16
879-1075-SS	REPAIR KIT, VALVE, 3/4" AUTORANGE/CONTROL, SST	120.21	90-02324	KIT, FILL FLOW, 40D F.M. METRIC, 71 SERIES MONITOR	1,823.54
879-1100-SS	REPAIR KIT, 1" SST AUTO- RANGE AND CONTROL VALVE	142.12	90-02326	KIT, FLOW VOLUME, METRIC w/o FLOWMETER	831.45
879-1150-SS	REPAIR KIT, 1-1/2" SST AUTO-RANGE/CONTROL VALVE	175.90	90-02328	KIT, RPM	949.23
879-1200-SS	REPAIR KIT, VALVE, 2" AUTORANGE/CONTROL SST	221.55	90-02334	KIT, DUAL RPM	992.67
879-2008	VALVE, HYDRAULIC FLOW CONTROL, 2-8 GPM	2,123.28	90-02347	KIT, FILL FLOW	934.76
879-2030	VALVE, HYDRAULIC FLOW CONTROL, 16 - 30 GPM	2,123.28	90-02349	KIT, RAM MNT/SUCTION CUP CENTERLINE 220	157.36
879-2031	VALVE, HYDRAULIC FLOW CONTROL,16-30 GPM,18' CBL	2,253.48	90-02353	KIT, SPEED/PRESSURE AREA 70 SERIES	1,365.87
879-2242	MANIFOLD, 2 SAE #12 PORT	155.65	90-02356	KIT, FLOW VOLUME, 16D 3/4" HOSE BARBS	1,242.61
879-2243	MANIFOLD, W/LOGIC ELEMENT	449.87	90-02357	KIT, FLOW VOLUME, 10D, 1/2" HOSE BARBS	1,242.95
880-0004	VALVE, 3/4" MULTIPOINT SHUTOFF	109.37	90-02359	KIT, RAM 1" BALL, 3" ARM 1-DIAMOND, 1 ROUND	88.23
89-04000	LUBRICATING GREASE, 5.3oz DOW CORNING 111	98.60	90-02364	KIT, UPDATED MT500, FITTING, w/LATCH HANDLE	436.35
90-02005	KIT, POWER CABLE 18" W/ TUBING & BULLETIN	52.99	90-02371	KIT, GPS SPEED SENSOR MID-TECH CONTROLS	742.23
90-02010	KIT, SPEED SNSR, MECH. (4) WHEEL, AGCO #WR55985	1,097.69	90-02386	KIT, GPS SPEED SENSOR FOR TEEJET CONTROLS	742.23
90-02079	KIT, ARC 6000 CE FLOATER SINGLE CONVEYOR	4,153.86	90-02390	KIT, TASC 6100, STANDARD FLOW CTRL, 20 GPM, S-25	8,651.66
90-02092	KIT, ANTENNA, DISK AND ADHESIVE	41.00	90-02404	KIT, GPS SPEED SENSOR RAVEN CONTROLS	742.23
90-02109	KIT, CABLE SET	830.42	90-02439-MD	KIT, 744, 3-BOOM 100 PSI, BALL VALVE HARNESS	685.84
90-02152	KIT, RADAR, RVS II, TJ w/BACKET & ADAPTER CABLE	2,406.88	90-02439-MP	KIT, 744A 3-BOOM 100 PSI, METRI-PACK BALL VALVE HARNESS	685.84
90-02154	CONSOLE KIT,ARC-6000 CE SFTWR 2.03	2,880.59	90-02439-UX	KIT, 744, 3-BOOM 100 PSI , BALL VALVE HARNESS	685.84
90-02156	CONSOLE KIT, TASC 6100,CE SFTWR M-1.30, SLAVE 2.31	4,117.24	90-02463	KIT, SEAL FOR VALVES 35-02056 & 879-3100	220.42
90-02157	CONSOLE KIT, TASC 6300 CE SFTWR M-3.23, SLAVE 3.05	6,033.45	90-02472	KIT, PATCH ANTENNA, EXT. 10'	189.72
90-02158	CONSOLE KIT TASC 6600 CE SFTWR M-3.23,SLAVE 3.05	7,336.48	90-02476	KIT, PRESSURE SENSOR, 0-145 PSI/ 0-10 BAR	448.03
90-02175	KIT, 801 F.M. & INTERFACE w/3/4" HOSE BARBS	811.47	90-02477	KIT, 70 SERIES, PRESSURE SENSE ONLY	1,686.36
90-02176	KIT, 801 F.M. & INTERFACE w/1" HOSE BARBS	835.19	90-02482	KIT, PRESSURE SENSOR, 0-363 PSI/ 0-25 BAR	444.73
90-02177	KIT, 801 F.M. & INTERFACE w/1-1/4' HOSE BARBS	811.47	90-02502	KIT, RAVEN SMARTCABLE POWER w15A FUSE 5' LONG	46.51
90-02178	KIT, 801 F.M. & INTERFACE w/1-1/4" NPT (F)	835.19	90-02522	KIT, RPM, w/INDUCTIVE SENSOR	1,014.40
90-02211	KIT, TASC PUMP DRIVER MODULE, TB	1,344.58	90-02538	KIT, MT500 MODULE w/SNSR BRACKET, REPLACEMENT	561.05
90-02252	KIT, REPAIR, 801 FLOWMETER	355.08	90-02546	KIT, REAL VIEW CAMERA w/MOUNT & 20FT EXTENSION	472.61
			90-02565	KIT, VIDEO SELECTOR w/4 CAMERAS & 20' EXT.	2,769.23
			90-02572	KIT, BOOMPILOT SDM/HARNESS, GENERIC	2,257.83
			90-02577	KIT, PATCH ANTENNA EXT. 25'	293.06
			90-02584	KIT, 70 SERIES SPEED AREA DISTANCE,w/GPS SPEED SNSR	1,468.97
			90-02585	KIT, 834-P w/GPS SPEED SENSOR	3,220.31

# COMPREHENSIVE LIST

PART NO.	DESCRIPTION	U.S. DOLLARS	PART NO.	DESCRIPTION	U.S. DOLLARS
90-02595	KIT, IC18 FILE DOWNLOAD	306.57	90-02862-PTC-375	KIT, SINGLE FLOW SENSOR ASSY, w/PTC 3/8" FM	368.28
90-02661	KIT REAL VIEW CAMERA W/MOUNT	346.59	90-02868	KIT, GPS SPEED SENSOR FOR RADION CONSOLE	742.23
90-02666	KIT, BOOMPILOT SDM/HARNESS, TEEJET 844	2,257.83	90-02871	KIT, SENTRY 6140 CONSOLE	997.37
90-02667	KIT, BMPLT, SDM/HARNESS RAVEN 440-460	2,257.83	90-02885	KIT, DUST CAP, DT PLUG, SIZE 18	83.51
90-02669	KIT, BMPLT, SDM/HARNESS RAVEN SPRA COUPE 3000/4000 SERIES	2,887.91	90-02886	KIT, DUST CAP, DT RECEPTACLE, SIZE 18	53.58
90-02671	KIT, BMPLT SDM/HARNESS,WILLMAR W/ M-T Cont.,Air Ride,Eagle 8100,8500,Rangers	2,257.83	90-02887	KIT, DYNAJET 7120 CONSOLE, W/SUCTION MOUNT	981.80
90-02672	KIT, BOOMPILOT SDM/HARNESS, SPRA COUPE 7XXX w/ RAVEN 4000/5000	2,257.83	90-02889	KIT, BASIC, SENTRY 6140, SINGLE SECTION	1,918.01
90-02674	KIT, BOOMPILOT SDM/HARNESS, 844 CLASSIC, US	2,257.83	90-02902	KIT, SINGLE FLOW SENSOR ASSEMBLY, w/ 50" SENSOR	445.01
90-02678	KIT, BOOMPILOT SDM/HARNESS, HAGIE, SPLIT SIGNAL, RAVEN 460	2,257.83	90-02902-PTC-250	KIT, SINGLE FLOW SENSOR ASSY, w/ 50" SENSOR, w/PTC 1/4" FM	445.01
90-02680	KIT, BOOMPILOT SDM/HARNESS, ROGATOR '03 - '06, DT CONN. 8 POS.	2,257.83	90-02902-PTC-312	KIT, SINGLE FLOW SENSOR ASSY, w/ 50" SENSOR, w/PTC 5/16" FM	445.01
90-02681	KIT, BOOMPILOT SDM/HARNESS, APACHE '09-'10 RAVEN 5000	2,257.83	90-02902-PTC-375	KIT, SINGLE FLOW SENSOR ASSY, w/ 50" SENSOR, w/PTC 3/8" FM	445.01
90-02682	KIT, BOOMPILOT SDM/HARNESS, 844E-10	2,257.83	90-02903	KIT, DUAL FLOW SENSORASSEMBLY, w/ 50"" SENSORS	621.75
90-02683	KIT, BOOMPILOT SDM/HARNESS, NON-AGCO W/ RAVEN 4400 - 4600	2,257.83	90-02903-PTC-250	KIT, DUAL FLOW SENSOR ASSY, w/ 50" SENSORS, w/PTC 1/4" FM	621.75
90-02694	KIT, 5 BOOM SWITCHBOX	1,348.66	90-02903-PTC-312	KIT, DUAL FLOW SENSOR ASSY, w/ 50" SENSORS, w/PTC 5/16" FM	621.75
90-02700	KIT, RAM MOUNT w/4.5" SUCTION CUP MATRIX 840G	204.69	90-02903-PTC-375	KIT, DUAL FLOW SENSOR ASSY, w/ 50" SENSORS, w/PTC 3/8" FM	621.75
90-02719	KIT, REAL VIEW CAMERA w/MNT & 60 FT EXTENSION	615.44	90-02906	KIT, BASIC SENTRY 6141, SINGLE SECTION BOOM SENSE	1,760.85
90-02720	KIT RXA-30 NANTENNA W/20'/6M CABLE	829.65	90-02907	KIT, BASIC SENTRY 6141, MULTIPLE SECTION BOOM SENSE	1,834.23
90-02721	KIT, RXA-30 ANTENNA, 30'	892.66	90-02926	KIT, DUSTCAP, MP150 MALE	14.61
90-02725	KIT, SUCTION CUP W/1" BALL	189.08	90-02927	KIT, ADAPTERS, CNH ISOBUS 2150 SERIES PLANTERS	193.38
90-02738	KIT, GPS PATCH ANTENNA, w/MOUNTING HARDWARE	337.53	90-02932	KIT, LIGHTBAR w/CAN TEE ADAPTER CABLE	1,173.92
90-02748	KIT, MOUNTING PLATE FOR ANTENNA	37.86	90-02934	KIT, SENTRY 6141, CNHI 2000 SERIES PLANTERS	2,347.79
90-02756	KIT, BOOMPILOT SDM/HARNESS, '10 AND NEWER HAGIE STS	2,257.83	90-02941	KIT, SENTRY 6141, CNHI 1200 SERIES PLANTERS	2,347.79
90-02760	KIT, BOOMPILOT SDM/HARNESS, 12 POS ROGATOR DT-12 1054/1254/1264	2,257.83	90-02942	KIT, GNSS RECEIVER, RX720, DUAL FREQ., TSL READY, CP, NO-SBAS	4,122.24
90-02762	KIT, 70 SERIES TURF	1,837.43	90-02943	KIT, GNSS RECEIVER, RX720, DUAL FREQ., TSL READY, CP, SBAS	4,122.24
90-02803	KIT, BMPLT, SDM/HARNESS, MILLER G SERIES CONDOR, RAVEN 5000	2,257.83	90-02944	KIT, GNSS RECEIVER, RX720, DUAL FREQ., TSL & TSC-PRO READY, CP, SBAS	7,181.66
90-02807	KIT, BOOMPILOT SDM/HARN. 844E-5/7/9 W/ MASTER VALVE	2,257.83	90-02945	KIT, GNSS RECEIVER, RX720, DUAL FREQ., TSL & TSC-PRO READY, CP, NO-SBAS	7,181.66
90-02808	KIT, RAM MOUNT, MATRIX 570 NO SUCTION CUP	103.83	90-02946	KIT, GNSS RECEIVER, RX720, DUAL FREQ., TSL/TSC-PRO/TSX READY, CP, SBAS	9,575.98
90-02809	KIT, RAM MOUNT, MATRIX 840, NO SUCTION CUP	154.09	90-02948	KIT, SENTRY 6141, CNHI 1200 SERIES PLANTERS, 12 ROW	6,120.40
90-02846	KIT, SENTRY 6120 DROPLET SIZE MON. PRESSURE SENSOR, US CIG CABLE	1,469.19	90-02949	KIT, SENTRY 6141, CNHI 1200 SERIES PLANTERS, 16 ROW	7,263.22
90-02847	KIT, SENTRY 6120 DROPLET SIZE MON. PRESSURE SENSOR, EU CIG CABLE	1,469.19	90-02950	KIT, SENTRY 6141, CNHI 1200 SERIES PLANTERS, 24 ROW	9,548.87
90-02848	KIT, SENTRY 6120 DROPLET SIZE MON. PRESSURE SENSOR, BAT.TERM CABLE	1,476.85	90-02951	KIT, SENTRY 6141, CNHI 1200 SERIES PLANTERS, 36 ROW	12,977.35
90-02852	KIT, TIP FLOW MONITOR SYSTEM	1,112.46	90-02952	KIT, SENTRY 6141, CNHI 2000 SERIES PLANTERS, 12 ROW	6,120.40
90-02860	KIT, BASIC SENTRY 6140, MULTIPLE SECTIONS (1-15)	2,071.42	90-02953	KIT, SENTRY 6141, CNHI 2000 SERIES PLANTERS, 16 ROW	7,263.22
90-02861	KIT, DUAL FLOW SENSOR ASSEMBLY	583.10	90-02954	KIT, SENTRY 6141, CNHI 2000 SERIES PLANTERS, 24 ROW	9,548.87
90-02861-PTC-250	KIT, DUAL FLOW SENSOR ASSY, w/PTC 1/4" FM	583.10	90-02955	KIT, SENTRY 6141, CNHI 2000 SERIES PLANTERS, 36 ROW	12,977.35
90-02861-PTC-312	KIT, DUAL FLOW SENSOR ASSY, w/PTC 5/16" FM	583.10	90-02974	KIT, RAM MOUNT, MATRIX 908	157.28
90-02861-PTC-375	KIT, DUAL FLOW SENSOR ASSY, w/PTC 3/8" FM	583.10			
90-02862	KIT, SINGLE FLOW SENSOR ASSEMBLY	368.28			
90-02862-PTC-250	KIT, SINGLE FLOW SENSOR ASSY, w/PTC 1/4" FM	368.28			
90-02862-PTC-312	KIT, SINGLE FLOW SENSOR ASSY, w/PTC 5/16" FM	368.28			

COMPREHENSIVE LIST



# COMPREHENSIVE LIST

PART NO.	DESCRIPTION	U.S. DOLLARS	PART NO.	DESCRIPTION	U.S. DOLLARS
90-02989	KIT, BOOMPILOT SDM/HARNESS, GENERIC, MATRIX 908	2,183.57	90-50239	KIT, 744, 3 BOOM, 100 PSI, NO CABLES	405.81
90-02990	KIT, BOOMPILOT SDM/HARNESS, TEEJET 844/845, MATRIX 908	2,183.57	90-50245	KIT, 801 FLOWMETER w/1-1/2" HOSE BARBS	713.55
90-02991	KIT, BMPLT, SDM/HARNESS RAVEN 440-460, MATRIX 908	2,183.57	90-50249	KIT, 744E-3S, 100 PSI, 7 BAR w/HARNESSES	893.61
90-02992	KIT, BMPLT, SDM/HARNESS RAVEN SPRA COUPE 3000/4000 SERIES, MATRIX 908	2,183.57	90-50251	KIT, HARDWARE, 744E 744-3S, 744-5S	63.67
90-03005	KIT, VALVE REPLACEMENT 6 SEC. TELONE	547.77	90-50252	CORE KIT, 844AB-4, w/o CABLES	2,196.74
90-04005	KIT, DSM PRESSURE INTERFACE 10FT.	926.40	90-50254	KIT, 744E-3S, 100PSI, W/430 DIN HARNESS, BAT. TERM CABLE	989.62
90-04006	KIT, DSM PRESSURE INTERFACE 32FT.	957.09	90-50255-MD	KIT, 5 SECTION, 744E, 100PSI, MINI-DIN HARNESS, BAT. TERM CABLE	1,117.36
90-04007	KIT, PSI, DYNAJET 145 PSI (10 BAR) 6'	726.63	90-50255-MP	KIT, 5 SECTION, 744E, 100PSI, METRI-PACK HARNESS, BAT. TERM CABLE	1,117.36
90-06007	PUMP, MID-TECH, TASC	5,682.18	90-50255-UX	KIT, 5 SECTION, 744E, 100PSI, 4 POS WP HARNESS, BAT. TERM CABLE	1,117.36
90-06019	KIT PUMP PISTON .5-50 OUNCES	4,629.82	90-50256	KIT, REPAIR, 802 FLOWMETER	355.08
90-06020	KIT PUMP PISTON 1-100 OUNCES	6,171.93	90-50258	KIT, CLAMP SST, 75 SERIES FLANGE WITH O-RING	19.88
90-06021	KIT, PISTON PUMP 1.5-150 OUNCES	7,494.95	90-50259	KIT, RADION 8140-5, RAM MOUNT, PWR CABLE, USER GUIDE	3,623.47
90-06023	PUMP TASC, REVERSE PRIME	5,637.74	90-50263	KIT, RADION 8140-7, RAM MOUNT, NO PWR CABLE, USER GUIDE	3,625.99
90-06026	KIT, PUMP PISTON TASC, w/MANIFOLDS, .5-50 OZ	4,850.69	90-50265	KIT, RADION 8140-9, RAM MOUNT, NO PWR CABLE, USER GUIDE	3,810.52
90-06027	KIT, PUMP PISTON, TASC w/MANIFOLDS, 1-100 OZ	6,394.52	90-50268	KIT, 845, MOUNTING BRACKET, PWR CABLE, USER GUIDE	1,721.11
90-06028	KIT, PUMP PISTON, TASC w/MANIFOLDS, 1.5-150 OZ	7,715.79	90-50272	KIT, 801 FLOWMETER, w/1" HOSE BARBS, RAVEN CONN.	713.55
90-06029	KIT, PUMP PISTON, TASC w/MANIFOLDS, 2-200 OZ	9,257.71	90-50273	KIT, 801 FLOWMETER, w/3/4" HOSE BARBS, RAVEN CONN.	713.55
90-06034	MT 600 PUMP, 1-100 OZ, w/DCM HARNESS	6,611.74	90-50274	KIT, 801 FLOWMETER, w/1-1/4" HOSE BARBS, RAVEN CONN.	713.55
90-06036	MT 500 PUMP, TASC, NO CAL VALVE	5,475.74	90-50275	KIT, 802 FLOWMETER, w/1-1/4" HOSE BARBS	793.57
90-06039	MT 500 PUMP, TASC w/REV. PRIME,NO CAL VALVE	5,707.16	90-50276	KIT, 744E-5S, 100PSI, w/430 DIN+MSTRHARNESS, BAT. TERM. CABLE	1,214.18
90-06045	MT 600 PUMP, 2-200 OZ, w/DCM HARNESS	9,031.64	90-50277	KIT, 802 FLOWMETER,w/1-1/2" HOSE BARBS	793.57
90-06046	MT500 PUMP, w/DCM HARNESS	5,705.43	90-50280	KIT, 744E-3S, 300PSI, W/430 DINHARNESS, BAT. TERM CABLE	989.62
90-06048	MT600 PUMP 2 HEAD NO CABLES	6,184.43	90-50281-MD	KIT, 5 SECTION, 744E, 300PSI, MINI-DIN HARNESS, BAT. TERM CABLE	1,117.36
90-06049	MT600 PUMP 3 HEAD NO CABLES	7,311.61	90-50281-MP	KIT, 5 SECTION, 744E, 300PSI, METRI-PACK HARNESS, BAT. TERM CABLE	1,117.36
90-06050	MT600 PUMP 4 HEAD NO CABLES	8,602.48	90-50281-UX	KIT, 5 SECTION, 744E, 300PSI, 4 POS WP HARNESS, BAT. TERM CABLE	1,117.36
90-06051	MT500 PUMP, w/DCM HARNESS NO CAL VALVE	5,589.61	90-50287	KIT, HARDWARE, 744E	63.67
90-06052	PUMP, MT500 w/DCM HARNESS w/AGIT. OUT, CAL VALVE	6,198.69	90-50289	KIT, 3 SECTION 744A, 100 PSI, POWER CABLE	418.44
90-06054	PUMP MT500,w/DCM HARN. w/AGIT OUT, NO CAL VALVE, 1/4" TUBE	6,082.88	90-50290	KIT, 3 SECTION 744A, 300 PSI, POWER CABLE	418.44
90-50002	KIT,T-TAP ACCESSORY BAG 37226	26.52	90-50291	KIT, 5 SECTION 744E, 100 PSI, POWER CABLE	646.12
90-50006	KIT, HOSE BARB 45916-1000	132.88	90-50292	KIT, 5 SECTION 744E, 300 PSI, POWER CABLE	646.12
90-50008	KIT, HOSE BARB, (32mm) 45916-1250	95.27	90-50294	KIT, DIAGNOSTIC, ISO-DYNAJET HARNESS	1,403.55
90-50013	KIT, CABLE TIE BUNDLE (15)	40.64	90-50300	KIT, 844AB-4, MOUNTING BRACKET, PWR CABLE, USER GUIDE	2,273.60
90-50026	KIT, HB 1-1/2", F/1-1/2" 45977-1500	127.66	908-0002	CONTAINER 60 oz.	60.64
90-50030	KIT, HB, 3/4" F/3/4" FM 38443-750	127.66	91-00018	KIT, MATRIX FIELDPILOT NEW SYSTEM	4,464.53
90-50141	KIT, ACCESSORY BAG 37225-COMMAT	63.67	91-02286	KIT, PWM PLATFORM CASE 71xx 72xx, 89xx	4,640.22
90-50143	KIT, CORE, 845, WITHOUT CABLES	1,649.18	91-02287	KIT, PWM, PLTFRM APACHE AS710 850,1000,1010,1200,1210	4,640.22
90-50149	KIT, CONSOLE 744A-100L-3	462.05	91-02290	KIT, PWM JD4700	4,640.22
90-50151-MD	KIT, 3 SECTION, 744A, 300PSI, MINI-DIN HARNESS, BAT. TERM CABLE	705.29	91-02291	KIT, PWM, JD 4710 & 4720	4,640.22
90-50151-MP	KIT, 3 SECTION, 744A, 300PSI, METRI-PACK HARNESS, BAT. TERM CABLE	705.29	91-02294	KIT, PWM JD 6x10, 6x20, 7x10,7x20, SF	4,640.22
90-50151-UX	KIT, 3 SECTION, 744A, 300PSI, 4 POS WP HARNESS, BAT. TERM CABLE	705.29	91-02296	KIT, PWM, JD8x20	4,640.22
90-50161	KIT, 744 3-BOOM 100 PSI w/244C 3/4 REG VALVE	567.87	91-02310	KIT, PWM ROGATOR 1064 1074	4,640.22
90-50163	SPRAYER_CONTROL_KIT	910.31	91-02313	KIT, FP PWM BASIC CC, LS, 2.1 GPM	4,640.22
90-50177	KIT, 744 3-BOOM 100 PSI w/244C 3/4 VLV & 144P	1,228.89	91-02323	KIT, ROGATOR 854, (97-2002)	5,282.54
90-50216	KIT, 744 3-BOOM 100 PSI w/244C 3/4 REG VALV (BST)	546.65	91-02327	KIT, PWM, MILLER CONDOR A75	5,282.54
90-50225	KIT, 834-P	2,625.32			
90-50230	KIT, 801 FLOWMETER, w/1" HOSE BARBS	713.55			
90-50231	KIT, 801 FLOWMETER, 3/4" HOSE BARB	713.55			
90-50232	KIT, 801 FLOWMETER, w/1-1/4" HOSE BARB	713.55			
90-50233	KIT, 801 FLOWMETER, w/1-1/4" NPT (F)	713.55			
90-50236	KIT, CLAMP SST, 50 SERIES FLANGE	19.46			

# COMPREHENSIVE LIST

PART NO.	DESCRIPTION	U.S. DOLLARS
91-02343	KIT, PWM, CASE SPX 3330	4,640.22
91-02346	KIT, PWM CAT 35/45/55 CHALLENGER ROW CROP	3,879.60
91-02400	KIT, UNIPILOT, NEW SYSTEM	9,165.96
91-02402	KIT, UNIPILOT, NEW SYSTEM, w/o POWER/CAN/ DATA CABLE	9,004.33
91-05020	KIT, UNIPILOT PRO, NO WAS	9,855.58
91-05023	ELECTRIC STEERING DEVICE, UNIPILOT PROTEEJET	4,594.34
91-05025	KIT, UNIPILOT PRO, NO WAS, MATRIX	10,003.77
91-05026	KIT, FIELDPILOT PRO NEW SYSTEM, AEROS	8,069.74
91-05027	KIT, FIELDPILOT PRO NEW SYSTEM, MATRIX	8,217.95
91-05028	SWITCH KIT, UNIPILOT PROTEEJET	1,406.50
91-05039	KIT, UNIPILOT PRO, NO WAS, MATRIX 908	10,074.23
91-07011	KIT, STEERING WHEEL SWITCH	104.88
91-07014	KIT, SEAL, BUNA, CB VALVE	52.46
91-07016	KIT, SEAL, FOR EC10-40 PRESSURE COMPENSATOR	54.71
95-70000	CONSOLE, LOANER, 39482-3 844-3	1,172.52
95-70001	CONSOLE, LOANER, 39482-5, 844-5	1,356.66
95-70003	CONSOLE, LOANER, 48348, 844E	1,356.66
95-70005	CONSOLE, LOANER, TEEJET, 854	1,689.44
95-70009	CONSOLE, LOANER, 46162, 844 AB	2,167.56
95-75000	CONSOLE, ARC-6000 RAW SFTWR. 2.03	2,011.13
95-75007	CONSOLE, TASC 6200 GRAN. MASTER 2.62, SLAVE 2.35	4,291.02
95-75008	CONSOLE, TASC 6500 GRAN. M-2.62, L-2.35, PUMP 2.26	5,160.40
95-75012	CONSOLE, TASC 6300 MASTER 3.23, SLAVE 3.05	4,427.22
95-75013	CONSOLE, TASC 6100 MASTER 1.30, FAN 2.31	2,948.56
95-75023	CONSOLE, ARC 6000 w/MAN. SFTWR., 2.03	1,918.59
95-75027	CONSOLE, TASC 6300 w/MAN. MASTER 3.23, SLAVE 3.05	3,968.06
95-75028	CONSOLE, TASC 6600w/MAN. MASTER 3.23, SLAVE 3.05	4,801.90
95-75031	CONSOLE, TASC 6100 w/MAN. MASTER 1.30, SLAVE 2.31	2,681.45
95-75042	CONSOLE, ARC-6000 CE, w/MAN. SFTWR 2.03	2,009.42
95-75048	CONSOLE, TASC 6300 CE w/MAN M-3.23, SL-3.05	4,636.68
95-75052	CONSOLE, TASC 6100 CE w/MAN M-1.30, FAN-2.31	2,948.56
95-75063	CONSOLE, L6K, RMS CB	7,041.87
95-75064	CONSOLE, L6K RMS EXT	7,041.87
95-75096	CONSOLE, RADION 8140-5 REMAN	2,439.51
95-78077	DCM, DUAL CONTROL MODULE	1,275.61
95-78087	MODULE, SCM, PRO, REMAN	3,240.43
95-78090	SECTION DRIVER MODULE, DM SOFTWARE, REMAN	1,008.19
95-78093	ANTENNA ONLY, RXA-30, REMAN	512.49
95-78095	SCM PRO w/UNIPILOT PRO ONLY TEEJET, REMAN.	4,380.93
97-00065	TOOL, REMOVAL, CINCH ME MOD ENCLOSURE	278.00
98-01467- ENUS	GUIDE, RADION QUICK-START US ENGLISH	50.38
98-01493	GUIDE, MATRIX 430 QUICK-START	18.26
98-05010	GUIDE, USER, TASC 6000, 6300, & 6600 CE & STANDARD	40.64
98-05012	GUIDE USER, ARC-6000 STANDARD VERSION ONLY	40.64
98-05017	GUIDE, USER, ARC 6000 CE & STANDARD	38.91
98-05018	GUIDE, USER, TASC 6100 CE & STANDARD	40.64
98-05051	GUIDE USER, 854	30.16
98-05151	USER GUIDE GUIDANCE BBI	16.57
98-05239	MANUAL, MATRIX PRO, UK ENGLISH	78.70
98-05305	MANUAL, SENTRY 6120 DROPLET SIZE MONITOR	18.26

PART NO.	DESCRIPTION	U.S. DOLLARS
	MANUAL, SENTRY 6140 TFM, US ENGLISH	25.46
98-05332	MANUAL, MATRIX 430	30.64
98-05341- ENUS	MANUAL, USER, FIELDPILOT PRO/ UNIPILOT PRO, US ENGLISH	25.46
98-05342- ENUS	MANUAL, UNIPILOT PRO INSTALL	28.80
	MANUAL, SENTRY 6141 ISOBUS TIP FLOW MONITOR	25.46
98-05345	MANUAL, DYNAJET 7140	53.60
98-50143	UNLOCK CODE, ABSC FOR RADION CONSOLE	1,151.58
98-50144	UNLOCK CODE, 3RD PARTY RATE CONTROL, MATRIX GS	1,151.57
98-50145	UNLOCK CODE, SPREADER, MATRIX GS	1,151.58
98-70003	MANUAL, MINI, 844 MI844L	19.44
98-70005	MANUAL, PLUMBING & INSTAL MI800	23.09
	MANUAL, 844E, US ENGLISH	28.41
98-70025	MANUAL, MAINT. INSTRUCT. MI 744A	28.22
98-70028	GUIDE, USER 834-P	25.46
98-70030	MANUAL, USER, 744E SPRAYER CONTROL	25.46
99-01070	UNLOCK CODE, SCM PROHYDRAULIC STEER	2,660.31
99-01071	UNLOCK CODE, SCM PRORTK STEER	2,660.31
99-01072	UNLOCK CODE, JD STEER, FIELDPILOT PRO	1,911.87
99-01073	UNLOCK CODE, STEER READY/STEER BY WIRE, FIELDPILOT PRO	1,319.04
99-01074	UNLOCK CODE, WHEEL ANGLE SENSOR (UNIPILOT PRO ONLY)	1,319.04
99-01078	UPGRADE, RX720 BASE UNIT TO TSC-PRO READY	3,125.93
99-01079	UPGRADE, RX720 TSC-PRO READY TO TSX READY	2,674.39
99-01080	UPGRADE, RX720, BASE UNIT TO TSC-PRO/TSX READY	5,518.93
99-01095	UNLOCK CODE, SCM PRO 4-WHEEL STEER	1,736.26
99-01131	UNLOCK CODE, IC45 VIRTUAL SWITCH BOX FEATURE	708.75
999-9021	REMOVAL TOOL, PACKARD TERMINALS	42.36
999-9022	REMOVAL TOOL, AMP TERMINALS	68.76
CG430-GLO	CONSOLE, MATRIX 430, GLONASS	2,106.49
DBT-E	TERMINATOR, END, IC7140	114.89
DBT-S	TERMINATOR, START, IC7140	122.80
DM-01	MODULE, DYNAJET IC7140	1,365.09
DP-01	MODULE, ISOBUS POWER DISTRIBUTION	912.24
DP-01-R	MODULE, ISOBUS POWER DIST., REVERSE	905.52
DP-02	MODULE, ISOBUS POWER DISTRIBUTION, w/ AUX. PWR OUT	1,019.85
DP-02-R	MODULE, ISOBUS POWER DISTRIBUTION, w/ AUX. PWR OUT, REVERSE	1,019.85
DPX-0300	DYNAJET POWER EXTENSION CABLE	324.06
DPX-0620	DYNAJET POWER EXTENSION CABLE	421.82
DPX-0910	DYNAJET POWER EXTENSION CABLE	519.60
DPX-1200	DYNAJET POWER EXTENSION CABLE	610.37
IC45-0050	IC45 SPRAYER ECU, .5m (1.6') CABLE	3,124.14
IC45-0400	IC45 SPRAYER ECU, 4m (13') CABLE	3,263.06
PLP12	PLP 12 Output Module	577.04
RXA-52-20	KIT, RXA-52, ANTENNA, 20'	1,241.15
RXA-52-30	KIT, RXA-52, ANTENNA, 30'	1,260.14
SW4731C-02	SWITCH, POWER, PUSH,	17.59

# NOTES

# NOTES

# NOTES

# NOTES

# NOTES



# TERMS AND CONDITIONS OF SALE

A small percentage of the items shown in this price list may not be produced under an ISO registered system. For further information contact your sales representative.

## (1) MODIFICATION OF TERMS

Seller's acceptance of any order is expressly subject to Buyer's assent to each and all of the terms and conditions set forth below and Buyer's assent to these terms and conditions shall be conclusively presumed from Buyer's receipt of this document without prompt written objection thereto or from Buyer's acceptance of all or any part of goods ordered. No addition to or modification of said terms and conditions shall be binding upon Seller unless specifically agreed to by Seller in writing. If Buyer's purchase order or other correspondence contains terms or conditions contrary to or in addition to the terms and conditions set forth below, acceptance of any order by Seller shall not be construed as assent to such contrary or additional terms and conditions or constitute a waiver by Seller of any of the terms and conditions.

## (2) PRICE

Unless otherwise specified: (a) all prices, quotations, shipments and deliveries by Seller are (i) EXW (Incoterms® 2010) if shipped to the Buyer within the United States, and (2) in all other circumstances DAP Buyer's location (Incoterms® 2010); (b) all base prices together with related extras and deductions, are subject to Seller's price in effect at the time of shipment; and (c) notwithstanding the use of the shipping term DAP and without any effect on the point at which the risk of loss shifts from Seller to Buyer, all transportation, import costs and other related charges are for the account of Buyer, including all increases or decreases in such charges prior to shipment. Payment of said price shall be due at the remittance address shown on the Seller's invoice upon receipt of Seller's invoice unless otherwise specified. Interest will be charged at a rate of 1 to 1 1/2% per month on all balances outstanding more than 30 days after the date of the invoice. Price includes Seller's standard packaging. Special packaging requirements shall be quoted at an additional price.

## (3) UNIFORM COMMERCIAL CODE

THIS IS A CONTRACT FOR THE SALE OF GOODS. SELLER AND BUYER EXPRESSLY AGREE THAT ANY SERVICES PROVIDED PURSUANT TO THIS CONTRACT ARE MERELY INCIDENTAL TO THE SALE OF GOODS, AND AS SUCH, SHALL BE DEEMED GOODS UNDER ARTICLE 2 OF THE UNIFORM COMMERCIAL CODE. SELLER AND BUYER FURTHER AGREE THAT ANY DISPUTES ARISING FROM THIS CONTRACT SHALL BE GOVERNED BY ARTICLE 2 OF THE UNIFORM COMMERCIAL CODE.

## (4) MINIMUM BILLING

Contact your regional office representative for any minimum order requirements.

## (5) WARRANTIES

Seller warrants that its products will substantially conform to and perform in accordance with the products' specifications. Seller warrants that the products do not infringe upon any copyright, patent, or trademark. THE FOREGOING WARRANTIES ARE IN LIEU OF ALL OTHER WARRANTIES, EXPRESSED OR IMPLIED, INCLUDING, BUT NOT LIMITED TO, THOSE CONCERNING MERCHANTABILITY AND FITNESS FOR A PARTICULAR PURPOSE.

## (6) LIMITATION OF REMEDIES

Buyer's remedies under this warranty shall be limited to the replacement, repair, or refund of the purchase price for any defective product at the Seller's option. Products claimed to be defective and for which repair or replacement is desired shall be, if requested by the Seller, returned transportation prepaid to Seller's plant for inspection. Results of ordinary wear and tear, improper

operation, or maintenance or use of corrosive or abrasive materials shall not be considered a defect in material or workmanship. Any component part manufactured by another is not covered by Seller's warranty, but only by such warranty as its manufacturer gives. Because of the difficulty of asserting and measuring damages hereunder, it is agreed that, except for claims for bodily injury, Seller's liability to the Buyer or any third party, for any losses or damages, whether direct or otherwise, arising out of the purchase of product from Seller by Buyer shall not exceed the total amount billed and billable to the Buyer for the product hereunder. IN NO EVENT WILL SELLER BE LIABLE FOR ANY LOSS OF PROFITS OR OTHER SPECIAL OR CONSEQUENTIAL DAMAGES, EVEN IF SELLER HAS BEEN ADVISED OF THE POSSIBILITY OF SUCH DAMAGES.

## (7) QUALITY ASSURANCE

Seller shall have no obligation to ensure that any goods purchased from Seller meet any special Buyer quality assurance specifications and/or other special Buyer requirements unless such specifications and/or other requirements are specifically set forth in Buyer's purchase order and expressly accepted by Seller. In the event that any such goods supplied by Seller in connection therewith, are applied to an end use without the appropriate specification and/or other requirement therefore having been set forth in Buyer's purchase order and expressly accepted by Seller, Buyer shall indemnify and hold Seller harmless against any and all damages or claims for damages made by any person for any injury, fatal or nonfatal, to any person or for any damage to the property of any person incident to or arising out of such application.

## (8) CLAIMS

Claims respecting the condition of goods, compliance with specifications or any other matter affecting goods shipped to Buyer must be made promptly and, unless otherwise agreed to in writing by Seller, in no event later than one (1) year after receipt of the goods buy Buyer. In no event shall any goods be returned, reworked or scrapped by Buyer without the express written authorization of Seller.

## (9) DEFAULT IN PAYMENT

If Buyer fails to make payments on any contract between Buyer and Seller in accordance with Seller's terms, Seller, in addition to any other remedies available to it, may at its option, (i) defer further shipments until such payments are made and satisfactory credit arrangements are reestablished or (ii) cancel the unshipped balance of any order.

## (10) TECHNICAL ASSISTANCE

Unless otherwise expressly stated by Seller, (a) any technical advice provided by Seller with respect to the use of goods furnished to Buyer shall be without charge; (b) Buyer shall have sole responsibility for selection and specification of the goods appropriate for the end use of such goods.

## (11) SAFETY PRECAUTIONS

Buyer shall require its employees to use all safety devices, and proper safe operation procedures as set forth in manuals and instruction sheets furnished by Seller. Buyer shall not remove or modify any such device or warning sign. It is the Buyer's responsibility to provide all means that may be necessary to effectively protect all employees from serious bodily injury which otherwise may result from the method of particular use, operation, set up or service of the goods. The operator's or machine manual, ANSI safety standards, OSHA regulations and other sources should be consulted. If Buyer fails to comply with provisions of this paragraph or the applicable standards and regulations aforementioned, and a person is injured as a result thereof, Buyer agrees to indemnify and save Seller harmless from any liability or obligation incurred by Seller.

## (12) CANCELLATION

Orders for goods specifically manufactured for Buyer cannot be canceled or modified by Buyer, and releases cannot be held up by Buyer, after such goods are in process except with the express written consent of Seller and subject to conditions then to be agreed upon which shall include, without limitation, protection of Seller against all loss.

## (13) PATENTS

The Seller shall not be liable for any costs or damages incurred by the Buyer as a result of any suit or proceeding brought against Buyer so far as based on claims (a) that use of any product, or any part thereof furnished hereunder, in combination with products not supplied by the Seller or (b) that a manufacturing or other process utilizing any product, or any part thereof furnished hereunder, constitute knowing and willful infringement of patents or trademarks arising from compliance with Buyer's designs or specifications or instructions.

## (14) COMPLETE AGREEMENT

THIS CONTRACT SETS FORTH THE ENTIRE AGREEMENT AND UNDERSTANDING OF THE PARTIES RELATING TO THE SUBJECT MATTER HEREOF, AND SUPERSEDES ALL PRIOR AGREEMENTS, DISCUSSIONS AND UNDERSTANDINGS BETWEEN THEM WHETHER ORAL OR WRITTEN, RELATING TO THE SUBJECT MATTER HEREOF.

## (15) GOVERNING LAW

All orders are accepted by Seller at its mailing address in Wheaton, Illinois, and shall be governed by and interpreted in accordance with the laws of the State of Illinois. The United Nations Convention on Contracts for the International Sale of Goods of April 11, 1980 shall be excluded.

## (16) FORCE MAJEURE

Neither party shall be in default of its obligations to the other party for any period of Force Majeure. "Force Majeure" shall mean any delay or failure of a party to perform its obligations to the other party due to causes beyond its control and without its fault or negligence. This shall include, without limitation, Acts of God, strike, civil commotion, acts of government, and any other comparable, non-foreseeable, and a serious event.

## (17) CONFIDENTIAL INFORMATION

Buyer shall maintain Confidential Information in confidence using the same care as used for its own Confidential Information. Buyer shall not disclose or divulge any Confidential Information received by it from Seller in connection with any products or services supplied by Seller to Buyer or to a third party without prior written consent of Seller, and Buyer may not use any Confidential Information for any purpose other than for the manufacture, sale and maintenance of Buyer's products. For the purposes hereof, "Confidential Information" includes any and all information and data, including, but not limited to, any business, commercial, intellectual property, technical information and data disclosed by Seller to Buyer in connection with the sale of Seller's products to Buyer, or relating to Seller's business relationship or the definition, development, marketing, selling, manufacture or distribution of Seller's products, whether disclosed orally, in writing or electronically, and irrespective of the medium in which such information or data is embedded, whether in tangible form or contained in an intangible storage medium. Confidential Information shall include any copies or abstracts made thereof, as well as any product, apparatus, modules, samples, prototypes or parts thereof.





# *TeeJet*<sup>®</sup> TECHNOLOGIES

## **Wheaton Facility**

North Ave and Schmale Rd  
P.O. Box 7900  
Wheaton, Illinois  
60187-7901 USA

## **Springfield Facility**

1801 Business Park Drive  
Springfield, Illinois  
62703 USA

## **Aabybro Facility**

Mølhavevej 2  
DK 9440 Aabybro  
Denmark