



**WILGER
SPRAYER &
LIQUID FERTILIZER
PARTS CATALOG**

REVISED DECEMBER 2022

WORLD CLASS SPRAYING COMPONENTS

Spray Tips



COMBO-JET[®]
Drift Reduction

Tip Wizard



**Spray Tip
Selection Tool**

Sprayer Parts



**Nozzle Bodies
& Plumbing Parts**

Flow Indicators



**Visual Detection
of Plugged Lines**

**FOR MORE
INFORMATION
VISIT**

WWW.WILGER.NET

Flow Monitoring



**Row-by-Row
Flowmeter**



©Copyright 2022 Wilger Industries Ltd.
All rights reserved.

UNITS: US GALLON/ACRE

New & Featured Products 3-5

Double-Down & Agrifac Outlet Adapters	3
COMBO-JET DX Series of Narrow Angle Nozzles	3
Wilger 3-hole Fertilizer Streamer (FS3) Nozzles	3
COMBO-RATE Top Turrets w/ Double-Down Outlets	4
COMBO-RATE Swivel Fence-row Nozzle Bodies	4
Quick-Flange Sprayer Boom Fittings.....	4
New ORS fittings & Electronic Flow Monitoring System	5

Spraying Resources & Topics 6-10

Combo-Jet Spray Nozzle Advantage & FAQ.....	6
Differences between ER/SR/MR/DR/UR series.....	6
Spray Quality, VMD & Droplet Size.....	7
Double-Down & Multi-Angle Spraying - When & Why?.....	7
How to Use Tip Wizard - First Time Users.....	8
Spray Tip Selection Guide for:	
Standard (Auto-Rate) Spray Systems.....	8
Pulse Width Modulation (PWM) Spray Systems	9
Double Nozzle (Double-Down or Multi-Angle) Spraying ...	10
Reducing 'Nozzle run-on' with top-fed bodies	34
Increasing Coverage with Crop-Adapted Spraying	38,40

Spray Nozzles, Metering & Adapters 11-31

ER Series Overview, 80° & 110°	11
SR Series Overview, 80° & 110°	12
MR Series Overview, 80° & 110°	13
DR Series Overview, 80° & 110°	14
UR Series Overview, 110°	15
80° Nozzle Charts (incl. ER/SR/MR/DR Series)	16-18
110° Nozzle Charts (incl. ER/SR/MR/DR/UR Series)	19-21
LERAP (UK) Nozzle Ratings	21
80° Nozzle Charts for PWM (Common Solenoid)	22-24
110° Nozzle Charts PWM (Common Solenoid)	25-26
COMBO-JET 3-hole Fertilizer Streamer (FS3) Caps	27-28
COMBO-JET Metering Orifices.....	27-28
Narrow Angle for Narrow & Spot Spraying	
- ER Series Spray Nozzles, 20°, 40° & 60°	29
- DX Series Spray Nozzles, 20°, 40° & 60°	29
Cap & Nozzle Adapters, incl. for non-Wilger caps	30
Slotted Nozzle Caps (for using insert-able tips).....	30
Flanged ER 80/110 Spray tips	30
Double-Down & Y-splitter Adapter Caps.....	31
Hose Barb, Threaded Outlet & Plug Caps.....	31
Quick-Connect (Push-in-tube) Caps	31
Strainers, Hose Drop & Extension Caps, Cap Fittings	31

Wet Boom Nozzle Bodies 32-38

Combo-Jet Swivel Bodies (1-3 Outlets)	32
KWIKSTOP™ Raised Inlet Nozzle Bodies	32-33
Square Lug Swivel Bodies (1-3 Outlets).....	33
Square Lug Caps, Strainers	33
Combo-Rate Nozzle Body Components & Accessories ...	34-38
Combo-Rate Saddles (Side Fed).....	34
Combo-Rate II One-Way Saddles (Top/Bottom Fed)	34
Combo-Rate II Two-Way Saddles (Top/Bottom Fed).....	34
Combo-Rate II Stacking Nozzle Bodies (Bottom Fed).....	35
Combo-Rate Body & Turret Replacement Parts	35,42
Combo-Rate Thru, End, and Swivel Fence-row Bodies	36
Combo-Rate Front, Side, & Top Turrets (3-5 Outlets).....	36-37
Combo-Rate Double-Down Turrets	36-37
Multi-Angle & Double-Down Spraying - Examples	38

Dry Boom Nozzle Bodies 39-42

Compact Nozzle Bodies	39
Swivel turret adapters (2-3 Outlets).....	39
Square-Mount Nozzle Bodies	39
High-Mount Nozzle Bodies.....	39
Low-Mount Compact Nozzle Bodies	40
Adjustable Swivel Bodies	40
Clamps for Sprayer Booms & 1/4" Bolt Mount Parts	41
Boomless Sprayer Nozzle Bodies & Assemblies.....	41
Estate Sprayer Manifold Parts & Assemblies	42

Sprayer Plumbing 42-47

Sprayer Boom Clamps.....	41
COMBO-RATE Control Manifolds & Components	42
1" Wilger Stainless Steel Tube (1.315" OD).....	43
1/2" Wilger Stainless Steel Tube (0.84" OD).....	43
1" Quick-Flange Fitting System (QF100).....	44-47
Boom Hygiene & Boom End Flush Valves	44-45,47
1" Quick Nut Fitting System (QN100)	48
1/2" Quick Nut Fitting System (QN50)	49
Case TWS Boom System Fittings.....	49
Recirculating Sprayer Booms	43-45

Liquid Fertilizer Parts 50-52

O-ring Seal Inlets & Outlets.....	50
O-ring Seal End Caps	50
O-ring Seal Check Valves.....	50
O-ring Seal Tees, Elbows & Plumbing Fittings	51
O-ring Seal Stackable Manifolds (1-4 Outlets).....	51
Replacement Parts & Mounting Clamps.....	51
O-ring Seal Metering Orifices.....	52

Liquid Fertilizer Monitoring 53-59

FLOW VIEW Visual Ball Flow Indicators	53
Benefits of Liquid Fertilizer Blockage	53
Required Column Storage & Telling Columns Apart.....	53
How to Build a Liquid Kit.....	54
Liquid Monitoring for Dark Liquids & Low Visibility	54-55
Which Flow Indicator Ball To Use	54
Wilger Electronic Flow Monitoring System & Parts.....	55-59

For Terms and Conditions, visit www.wilger.net

Wilger products are sold exclusively to original equipment manufacturers and authorized distributors, and are available to the end user through their retail dealerships.

Warranties - Wilger warrants that its products are free of defects in material and workmanship and perform to each product's specifications. The foregoing warranties are in lieu of all other warranties, written or expressed, including, but not limited to, those concerning suitability for a particular purpose. Claims under these warranties must be made promptly within one (1) year after receipt of goods by the buyer. Any warranty action by the buyer must be expressly pre-authorized by Wilger.

Technical Assistance - Wilger personnel are available to provide technical assistance in the choice and use of products furnished to the buyer and will do so free of charge. Wilger assumes no obligation or liability for any such advice, or any consequences occurring as a result of the application of such advice. The buyer is solely responsible for the selection of the appropriate product(s) and the appropriate application to the intended end use.

Limitation of Liabilities - Except for claims for bodily injury, Wilger's liability for any and all claims arising out of the purchase of the product shall not exceed the billed or billable value of the product. In no case will Wilger be liable for any consequential damages or loss of profit, even if Wilger has been advised of the possibility of such damages.

New Nozzle & Cap Adapters



COMBO-JET
Quarter-turn

40441-00

For COMBO-JET
& COMBO-RATE
Nozzle bodies



Double-Down Adapter sprays
two nozzles straight down

New options for Double-Down Spraying!

Ideal for high-volume applications, tough to reach targets, and making the most out of the nozzles you have on hand.

Easy-to-use
-TWISTLOCK™
Connection

40206-00

For non-Wilger
Nozzle outlets



*Converts a square-lug outlet to
Double-Down COMBO-JET outlets

New options for Agrifac Sprayers!

A handful of options to use Wilger caps & nozzles on Agrifac nozzle body outlets.



Agrifac to
COMBO-JET
Pop-in Sleeve-
40205-00

For Agrifac
Nozzle Bodies



The simple adapter sleeve snaps
into any COMBO-JET cap to
adapt to an Agrifac outlet



Adapter COMBO
for Double-Down on Agrifac



40441-00
+
40205-00



Agrifac to
COMBO-JET
Y-Adapter
40213-00

For Agrifac
Nozzle Bodies



The simple adapter uses two
existing COMBO-JET nozzles
split into two 30° angles.



60°

Agrifac™ is a trademark owned by Agrifac Machinery B.V.. All rights reserved.

COMBO-JET DX

Narrow Angle Drift Reduction
Nozzles available in 20° 40° & 60°



For Optical & Spot Spraying

Outlet Extensions

For extending nozzles to avoid
spray interference & more.



5" Extension
40211-00

2" Extension
40210-00

COMBO-RATE Manifolds for sprayers

Need to replace your yard sprayer's control manifold?
Building your own yard or ATV sprayer?

COMBO-RATE manifolds are modular and can be expanded or modified
with any COMBO-RATE fittings. Some pre-built manifolds are available.



41115-03
(w/o barbs & gauge)



41115-02
(w/o barbs & gauge)

Example Sprayer Manifold
for Booms & Wand

NEW 3-Hole Fertilizer Streamer (FS3) Nozzles

Precision molded & color-coded liquid fertilizer streamer caps for
consistent liquid fertilizer with less plant burn.

Includes metering orifice and deflector plate in a
single part number for easy ordering.



Improved
performance at
higher pressures

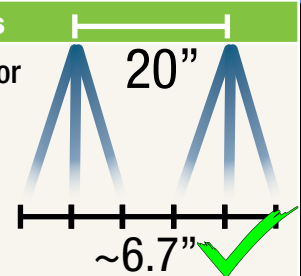

Available in sizes from 0.15 us gpm - 2.0 us gpm

Use Tip Wizard for Fertilizer Streaming Nozzle Selection

Simply input your intended application rate(s), speed, nozzle spacing
and you are well on your way to finding
the best fertilizer streamer nozzle for your spray applications.



NEW & FEATURED PARTS [Page 2]

COMBO-RATE® Top Turrets

A top take-off turret changes the orientation of the module for larger PWM solenoids. The top-turret is available with new **double-down spray outlets**.

COMBO-RATE top-turrets are compatibility with all stacking COMBO-RATE parts.

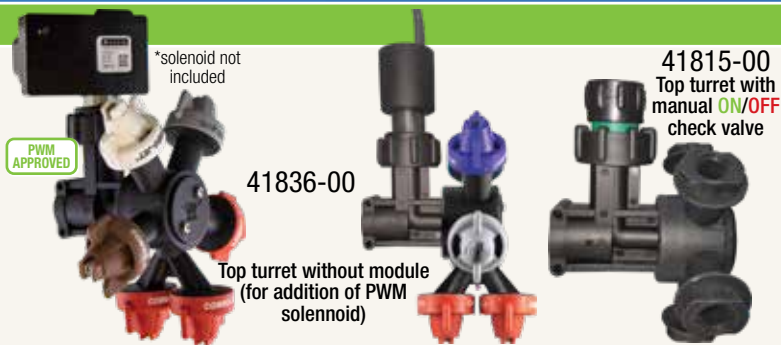

COMBO-RATE® Swivel End Body for Fence-row spraying



A new COMBO-RATE end body that provides a swivel joint that is **adjustable in 15° increments (via lock screw & teeth)**, and locked into place for crop adapted spraying or fence-row nozzle spraying.

Perfectly paired with the new COMBO-RATE Boom End Flush Valve for a compact and protected fence-row nozzle



COMBO-JET® Nozzle Bodies for PWM

Are you retrofitting your sprayer to PWM?

Cost-effective & compact nozzle body for any tight sprayer boom.



40623-NM
1" Combo-Jet Triple Swivel Nozzle Body



40663-NM
1" Square Lug Triple Swivel Nozzle Body

High-Flow COMBO-RATE II Bodies

Larger 21/32" inlet size nozzle bodies can provide significantly higher flow capacity than standard 3/8" inlets.

Check the COMBO-RATE section.



COMBO-RATE® Boom End Flush Valve

A super compact fitting including the last spray nozzle body, full flush valve, and recirculation port.



1.5" Super Compact Boom Ends



Engineered for Recirculating Spray Systems



Cuts out Boom Contamination



Passively Purges Air from the Top of the Boom



Recirculating boom port

2x Stackable COMBO-RATE nozzle body port

Full ID Flush Valve



Quick Flange Sprayer Boom Fittings

The sprayer boom fittings for the next generation of sprayers, equipped to improve equipment efficiency and application consistency.

Build a better sprayer boom today!

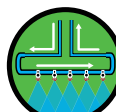

Perfect Recirc. Booms



Cutting out Boom Contamination



No Threads or Sealant Required



Stronger, Compact Fittings



High Flow Sweep Fittings

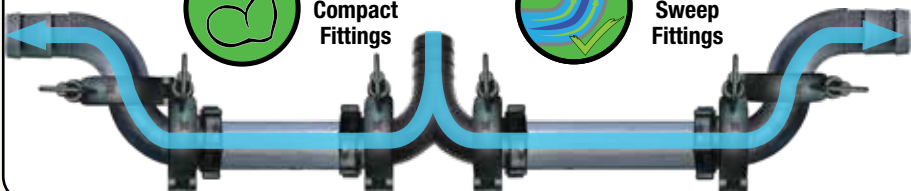

Compact Flush & Recirc



Future-proof for new fittings



Sweep Fittings



Easy Flange Boom End Conversion for QN SST



No Threaded Fittings



Easy Flange Boom End Conversion for 1" Pipe

New O-Ring Seal Fittings & Assemblies

NEW
ORS Straight Check Valves
 10 PSI
 Manual ON/OFF
 Check Valve,
 Straight
 20556-00



ORS Inline Strainer
 attaches to any ORS
 fitting
20576-00
 Strainer Assembly

20576-02
 50 Mesh
 Replacement
 Strainer

New ORS-F Hose Barbs



ORS to Square Lug
 Outlet for Liquid
 Fertilizer Kits
20549-00

20644-00
 4 Outlet EFM Manifold with new
 Straight 10 PSI
 Manual ON/OFF Check Valves



New pre-assembled Flowmeter Manifolds

New electronic flowmeter manifolds with straight check valve allow for easy ordering and building of systems.

Simply replicate each section of the implement with manifolds of the same size, cap off the ends, add a hose feed, and away you go.

Available in manifolds of 1-4 Outlets.

Wilger Electronic Row-By-Row Flow Monitoring System

The serviceable flowmeter designed & built specifically for agricultural chemical & liquid applications

Electronic Flowmeter
 [EFM]

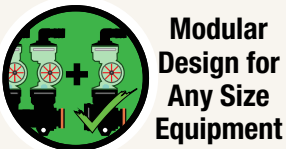
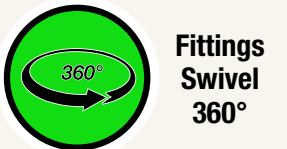
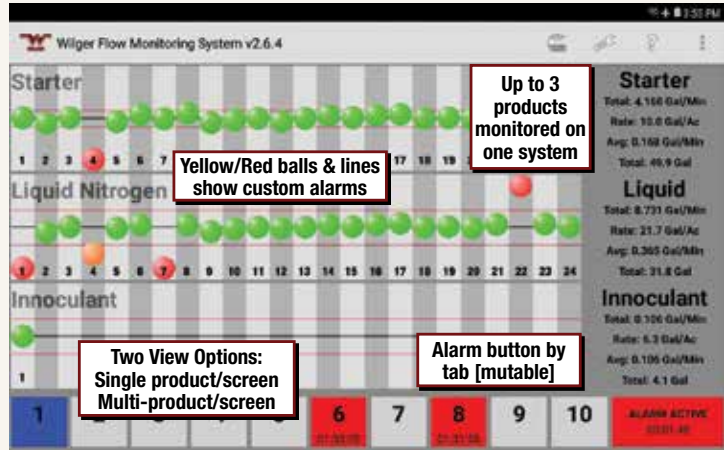
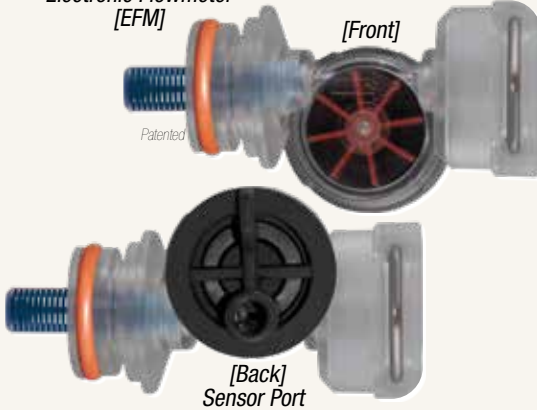

EFM systems are developed by OEM manufacturers using WILGER parts

Wilger Product Literature & Tools



Wilger provides free printed product literature, prices lists and tools. Request a copy today. All brochures are also available at www.wilger.net

FREE TIP WIZARD Tip Wizard Updates



Tip Wizard has new features! ORS metering orifice calculator, Flow Indicator Ball Selector, and further improved Tip Wizard spray tip search.

Tip Wizard aims to lead the industry as the best spray tip calculator for broadcast applications.

WHERE TO BUY WILGER PRODUCT

To find a list of local dealers/retailers and distributors in your area, visit the WILGER.net 'WHERE TO BUY' page, to easily enter your address to find local Wilger product.

The COMBO-JET® Spray Nozzle Advantage

- Less plugging, as the path of flow always gets larger
- 40% longer strainer that snaps & seals into place
- SR / MR / DR / UR
50% 75% 90% 90%+
Drift Reduction Series
- Cap color matched to flow rate
- Super long-lasting stainless steel spray tip
- The most versatile spray tips for Pulse Width Modulation Systems (e.g. Capstan Pinpoint®, EVO®, Case AIM Command®, John Deere ExactApply®, IntelliSpray®, Raven Hawkeye®, & more)
- Spray tip & cap are held together as one piece
- Easy-to-read label
(MR110-06 = MR Series, 110° tip, 0.6 US GPM flow rate)
- Best educational spray tip charts & tools provided to select the best spray tips
- Combo-Jet tips use a modern pre-orifice & closed chamber design that produces significantly less drift, creates solid mass droplets, for maximum spray velocity and more meaningful spray.

Without needing consistent air induction for drift reduction,
Combo-Jet spray tips are the preferred tip for Pulse Width Modulation (PWM) spraying systems.

*Capstan EVO®, Capstan Pinpoint®, Case AIM Command®, John Deere ExactApply®, IntelliSpray®, Raven Hawkeye®, Agrifac StrictSpray Plus™ are not affiliated or owned by Wilger. They remain property of their respective owner(s).

WILGER.NET has the most useful spray tip selection help in the world.

- FREE WILGER TIP WIZARD SMARTPHONE APP
- TIP WIZARD ONLINE
- EXCEL-BASED CHARTS
- PRINTED TIP CHARTS
- WILGER CATALOG

COMBO-JET® ER/SR/MR/DR/UR Spray Tips - What is the difference?

The sliding scale of droplet size means at any flow rate, you can match your desired spray quality.

5 Series of Spray Tips for a Sliding Scale of Droplet Size

Comparison Criteria	ER Series Extended Range	SR Series Small Reduction	MR Series Mid-Range Reduction	DR Series Drift Reduction	UR Series Drift Reduction
Spray Tip Design	Conventional Flat Fan	Pre-orifice Drift Reduction	Pre-orifice Drift Reduction	Pre-orifice Drift Reduction	Dual Chamber Drift Red.
Spray Quality @40PSI	Medium	Coarse	Extremely Coarse	Extremely Coarse	Ultra-Coarse
Droplet Size ¹ @40PSI	Smallest (246µ VMD ¹)	Medium (371µ VMD ¹)	Large (474µ VMD ¹)	Very Large (529µ VMD ¹)	Ultra Coarse (633µ VMD ¹)
% <141µ ² % <600µ ³	20% of volume < 141µ 94% of volume <600µ	8% of volume < 141µ 89% of volume <600µ	4% of volume < 141µ 74% of volume <600µ	2% of volume < 141µ 64% of volume <600µ	UR spray tips are specialty spray tips, designed for certain chemical applications that require exceptional drift reduction.
Drift Potential	Most likely to drift	Lower drift potential	Major reduction in drift	Very low drift potential	They are not to be replaced with other spray tip series that are not approved to be on the chemical label. Always follow up-to-date label information.
Coverage	Best	Excellent	Very good	Good	Refer to chemical application label for maximum pressures, speeds and application information.

¹Based on an XX110-06 nozzle @ 40 psi (2.75 BAR)

²Droplets smaller than 141µ are more likely to drift. 141µ is used as a standard for estimating driftable fines.

³Droplets smaller than 600µ provide better coverage. Droplets > 600µ consume more spray volume, reducing overall coverage.

More information available at www.wilger.net

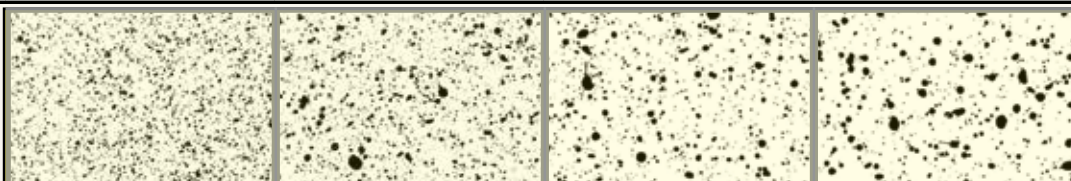

Selecting the Correct Spray Quality & Droplet Size

Drift vs. Efficacy

Generally speaking, smaller droplets deposit on the target more effectively than larger droplets, but larger droplets will drift less. So, when balancing drift control and efficacy, ensure to follow chemical labels and guidelines to designate the required spray quality and droplet size.

Where to find target spray quality or droplet size?

Depending on the chemical, as well as the different methods and modes of applications, some chemical labels may have less/more information. In general, chemical labels will have a description of how it should be applied, in the form of an ASABE spray classification recommendation, or a minimum spray classification (e.g. Spray at least ASABE Coarse). Some chemical label will also stipulate which nozzles can be used.

- Application Information:
- Water Volume: Minimum 22 L per acre. *Minimum volume requirement on chemical label*
 - Nozzles and Pressure: 30 to 40 psi (210 to 275 kPa) when using conventional flat fan nozzles. *Reference max pressure for conventional nozzles like ER series. Try avoid conventional (non-drift reduction) spray tips.*
- Low drift nozzles may require higher pressures for proper performance. Use a combination of nozzles and pressure designed to deliver thorough, even coverage of **ASABE coarse spray**. *Droplet spectrum recommendation for balance of drift & coverage.*

Example Spray Quality Chart by Type of Application

ASABE S-572.1 Classification Category	Color Code	Estimated VMD Range for Spray Quality*	Contact Insecticide & Fungicide	Systemic Insecticide & Fungicide	Contact Foliar Herbicide	Systemic Foliar Herbicide	Soil-Applied Herbicide	Incorporated Soil-Applied Herbicide	Fertilizer
Extremely Fine (XF)	Purple	Under 60							
Very Fine (VF)	Red	60-105							
Fine (F)	Orange	106-235							
Medium (M)	Yellow	236-340							
Coarse (C)	Blue	341-403							
Very Coarse (VC)	Green	404-502							
Extremely Coarse (XC)	White	503-665							
Ultra Coarse (UC)	Black	Over 665							

The above table provides general guidelines regarding droplet size and spray quality used in most spray applications.

It is always required that you carefully read and follow updated chemical manufacturers application label and instructions.

*NOTE: VMD range does not classify spray quality. Always ensure spray quality is followed first. VMD is a supplementary figure, and it is normal that nozzles with similar VMD can be classified into different spray qualities.

What about Multi-Tip Spraying? When to consider Double-Down & Angled Spraying

Potential problems with HIGH FLOW applications (15GPA+) with a single spray nozzle:

Spraying high volume out of a single tip can produce droplets that are ‘too large’ to be effective for coverage, which make for less effective spray application.

Using multiple spray tips at the same time can provide substantial gains in effective coverage into crops or applications that otherwise would be very difficult to cover; **however**, multi-tip spraying should not be used without reason.

A typical time to use **Multi-Angle spraying**:

For improved coverage on a vertical growing target (e.g. wheat) when you are needing to paint both sides of the plant with fungicide. (e.g. Fusarium Head Blight)



A typical time to use **Double-Down spraying**:

For high rate applications that rely on consistent coverage in a dense canopy. Use a nozzles to produce a meaningful mix of coarser and finer spray to hit different levels of the canopy.



Pairing already-owned nozzles to make a dual nozzle pair:

Much of the time, an operator already has 1-2 nozzles on the sprayer that could be stacked as a pair, so it is an effective way to use existing nozzles to improve spray application with very little cost.

A First-timer's look at Tip Wizard



Download on the App Store | GET IT ON Google Play

TRY IT FREE AT WWW.WILGER.NET

Tip Wizard shows great info like:

Adaptable Charts
Adjusts to alternate units & spacing
Boom Pressure (PSI)

Speed Range

Duty Cycle (for PWM)

Spray Quality

For matching spray tips to chemical label requirements

[Advanced] VMD (in µ)

Median Droplet Diameter for comparing series of the same tip size

% of Volume < 141µ

For an estimate of driftable fines in ideal conditions

% of Volume < 600µ

For a relative factor of small droplets in ideal conditions



Have More Questions?
Talk to your Wilger dealer,
or call
CANADA 1 (833) 242-4121
USA 1 (877) 968-7695

Beginner's Guide to using Tip Wizard

- Choose application units, spray system type, and search function** (e.g. Search for tips)
- Enter application rate, spraying speed¹, nozzle spacing, and spray tip angle².**
¹Since PWM systems can modulate flow by changing the spray duration, enter the MAX typical spraying speed.
²Spray tip angle required is based on nozzle spacing and boom height. Always maintain 100% overlap.

- Enter target spray quality or target droplet size (microns).**

<This is where Tip Wizard gets more useful>

Each chemical used in agricultural spraying has different spray quality requirements for best efficacy and also to maintain tolerable levels of driftable fines for spraying in ideal conditions. Using the droplet size (VMD) allows a more advanced way to filter through series of tips.

Where to find target spray quality or droplet size?

Depending on the chemical, as well as the different methods and modes of applications, some chemical labels may have less/more information. In general, chemical labels will have a description of how it should be applied, in the form of an ASABE spray classification recommendation, or a minimum spray classification (e.g. Spray at least ASABE Coarse)

Application Information: Minimum water requirement on chemical label by law Reference max pressure for conventional nozzles like ER series
 • Water Volume: Minimum 22 L per acre. Try avoid non-drift reduction tips.
 • Nozzles and Pressure: (30 to 40 psi (210 to 275 kPa) when using conventional flat fan nozzles. Low drift nozzles may require higher pressures for proper performance. Use a combination of nozzles and pressure designed to deliver thorough, even coverage of ASABE coarse spray. Droplet spectrum recommendation for balance of drift & coverage.

Spray Categories as per ASABE S572.1 Classification
 ■ Extremely Fine ■ Very Fine ■ Fine ■ Medium ■ Coarse ■ Very Coarse □ Extremely Coarse ■ Ultra Coarse

For the example chemical label application information, we'd have a classification of COARSE droplet size to follow.

Considering the mode of application as well as the action (e.g. systemic herbicide vs. contact herbicide), you can choose the spray quality that would suit your conditions as best as possible. REMEMBER: the larger the droplet size/VMD, the coarser the spray, resulting in less coverage.

For advanced users, using a VMD droplet size can further filter into a spray quality to make it easier to compare one series to another.

For an example, we might find we typically have windier conditions, so try filter our results to stay around 375µ-400µ for our targeted droplet size.

- Select the Best Spray Tip for your needs.**

Based on the operating speed, pressure, spray quality, and while also gauging the last few columns (VMD, % drift, % of small droplets for coverage), make a selection.

Picking Spray Tips for Auto-Rate Controlled Sprayers

- STEP 1: Size Your Tip** Since the application rate must be consistent, selecting a tip sized to the required rate over the actual sprayer speed range is critical. It is recommended to use Tip Wizard, as it will adjust the chart specifically for any application rate, not just common pairs of rate & speed.

FOCUS ON: SPEED & PRESSURE for a required APPLICATION RATE

Speed and pressure dictate a spray tip's ability to match a rate, and we must ensure our typical travel speed follows a reasonable pressure range. Meet your minimum speed (e.g. turning) within the operational pressure range. Having pressure too low in slow spots can lead to spotty coverage. Once you have referenced your chart to find your applied rate to your speed, you will find a certain nozzle size will be most effective.

***FOR PWM SPRAYERS (DUTY CYCLE):** Since you have more control of your pressure, your sprayer will typically allow for a wider selection of tip size. Try to pick a size that allows a duty cycle of 60-80% at your typical sprayer speed, allowing sufficient speed up/down.

- STEP 2: Filter to Your Spray Quality** Each chemical will require a nozzle spray quality (for labels that do not, consult chemical representative or agronomist, or general guide based on mode of action), since you have selected your tip size (e.g. 110-04) you can now find the best option within the series available in that nozzle size. The ER/SR/MR/DR/UR series differ based on spray quality & drift reduction.

FOCUS ON: 'ASABE S572' SPRAY CLASSIFICATION

Since the pressure is dictating the spray quality, you'll want to filter out any tip series that cannot apply the recommended spray quality.

***FOR PWM SPRAYERS (Pressure Selection):** Your spray quality can be changed with changing of sprayer pressure. This means instead of maintaining the required quality through a fixed operating pressure range, you can maintain a more flexible pressure range (provided duty cycle is OK).

- STEP 3: Double Check** It is worthwhile to review extra information provided for the spray tip, and re-evaluate if necessary. While the extra information in extrapolated from lab conditions without active ingredients, and cannot be considered actual, but it does lend to paint a picture of differences between series.

[ADVANCED] FOCUS ON: Spray % <141µ, Spray % <600µ, VMD (µ)

The extra columns reinforce the different spray qualities between different series, but also give the ability to make a rough spray plan for managing real life spraying conditions.

Spray % <141µ: % of total spray that can be considered driftable fines. In ideal conditions, it would be reasonable to assume this spray is NOT going where you want it to go. Due to evaporation before absorption, off-target spray or inversion, very small droplets will not likely hit target. Ideally have a spray tip that minimizes driftable fines, BUT ensure you maintain an acceptable level of coverage.

As speed, wind conditions & boom height increase, observed spray drift will increase substantially.

Spray % <600µ: % of total spray that can be considered small droplets. As % of these useful droplets lowers, coverage is reduced.

Consider it the 'other half' of the spray application, focusing on small droplets for coverage. Whereas you should maintain a low %<141µ, try to keep a %<600µ as high as possible, to maintain better coverage. As a very rough guideline with some usually chemical applications, aim for ~80+% <600µ for systemic applications; or ~90+% <600µ for contact applications; provided drift reduction levels are met and are satisfactory.

VMD (µ): The volumetric median diameter is the middle-point of spray distribution, and can be used to estimate between different series of the same size spray tips (tested on the same laboratory equipment). It is not for comparing between brands of tips. If you are familiar with using a VMD in tip searches, you can use it as an intensive filter to further focus in on tips that might work for your application. For example, if you are happy with spray application with the MR110-04 at 50PSI (346µ VMD), the spray quality might be comparable to an SR110-06 at 50 PSI (337µ VMD). Bear in mind, VMD is used for educational purposes only, and should not dictate application.

For more Guides, Videos & Reading on proper nozzle selection, visit www.wilger.net

We aim to have all sorts of ways to help make the best educated decision in picking and using spray tips, so if there is something you find would be helpful, don't hesitate to reach out and ask. Often, we cannot provide EVERYTHING there is to know in our guides, as it can be overwhelming, so if you are wanting to get more information from an expert, contact WILGER.

Picking Spray Tips for Pulse Width Modulation (PWM) Sprayers

NOTE: PWM Spray systems differ in some respects (max flow capacity, pulse frequency (Hz), and other general variations in operation. This guide is a general guide that applies to most PWM spray systems, but for clarification would be based on a 10Hz solenoid, with a relative max flow capacity of 1.5 us gpm (this determines the relative pressure drop). Wilger does not own, produce, or have any ownership of PWM spray systems. All rights reserved by their owners.

- 1 STEP 1: Size Your Tip** Since the application rate must be consistent, selecting a tip sized to the required rate over the actual sprayer speed range is critical. It is recommended to use Tip Wizard, as it will adjust the chart specifically for any application rate. Since PWM sprayers have control of sprayer pressure, a PWM sprayer will typically allow for a wider selection of tip sizes.

FOCUS ON: SPEED, PRESSURE & DUTY CYCLE (DC%) for a required APPLICATION RATE

Speed, pressure and respective duty cycle dictate a spray tip's ability to match a rate, and we must ensure our typical travel speed follows a reasonable pressure range. Having duty cycles <50% can degrade spray quality and consistency of spray swath, so it is always recommended to be above that.

Try to pick a size that allows a duty cycle of 60-80% at your typical sprayer speed, allowing sufficient speed up/down. If a nozzle is approaching 90-100% at your maximum sprayer speed at your highest pressures, this can be a good indication that a nozzle is sufficiently sized.

Before you look at any coverage/spray quality characteristics of a nozzle, you should have solidified which nozzle SIZE will work best first.

- 2 STEP 2: Filter to Your Spray Quality** Each chemical will require a nozzle spray quality (for labels that do not, consult chemical representative or agronomist, or general guide based on mode of action), since you have selected your tip size (e.g. 110-04) you can now find the best option within the series available in that nozzle size. The ER/SR/MR/DR/UR series differ based on spray quality & drift reduction.

FOCUS ON: 'ASABE S572' SPRAY CLASSIFICATION

Since the pressure is dictating the spray quality, you'll want to filter out any tip series that cannot apply the recommended spray quality. Since PWM gives full control of sprayer pressure, this will usually filter the results to 1-2 nozzles within a size or series.

- 3 STEP 3: Pick your most flexible spray nozzle** It is worthwhile to review extra information provided for the spray tip, and re-evaluate if necessary. While the extra information in extrapolated from lab conditions without active ingredients, and cannot be considered actual, but it does lend to paint a picture of differences between series.

The goal is to select a nozzle that can be applied at relatively moderate pressures (e.g. 50-60PSI) when spray conditions are ideal, giving a means to reduce pressure to 30-40PSI to have a 'drift reduction mode' that can be called upon when less ideal conditions arrive.

[ADVANCED] FOCUS ON: Spray % <141µ, Spray % <600µ, VMD (µ)

The extra columns reinforce the different spray qualities between different series, but also give the ability to make a rough spray plan for managing real life spraying conditions.

Spray % <141µ: % of total spray that can be considered driftable fines. In ideal conditions, it would be reasonable to assume this spray is NOT going where you want it to go. Due to evaporation before absorption, off-target spray or inversion, very small droplets will not likely hit target. Ideally have a spray tip that minimizes driftable fines, BUT ensure you maintain an acceptable level of coverage.

As speed, wind conditions & boom height increase, observed spray drift will increase substantially. With wind speeds of 12mph+, it can be expect to have driftable fine spray double. Windy conditions, higher drift sensitivity, and other environmental reasons are serious considerations for what might be an acceptable level of driftable fines.

By general chemical mode of action, you might have a reference point for % driftable fines, which might be generalized as:

Systemic Herbicides: Try maintain driftable fines <10%. (For very sensitive applications and herbicides, the requirement might go down to even 1.5-5%)

Contact Herbicides & Fungicides: Try maintain driftable fines <15%. This allows for a consistent and high level of coverage without losing a great deal to driftable fines. It is often part of a good balance between driftable fines and coverage.

Spray % <600µ: % of total spray that can be considered small droplets. As % of these useful droplets lowers, coverage is reduced.

Consider it the 'other half' of the spray application, focusing on small droplets for coverage. Whereas you should maintain a low %<141µ, try to keep a %<600µ as high as possible, to maintain better coverage. As a very rough guideline with some usually chemical applications, aim for ~80+% <600µ for systemic applications; or ~90+% <600µ for contact applications; provided drift reduction levels are met and are satisfactory.

VMD (µ): The volumetric median diameter is the middle-point of spray distribution, and can be used to estimate between different series of the same size spray tips (tested on the same laboratory equipment). It is not for comparing between brands of tips. If you are familiar with using a VMD in tip searches, you can use it as an intensive filter to further focus in on tips that might work for your application. For example, if you are happy with spray application with the MR110-04 at 50PSI (346µ VMD), the spray quality might be comparable to an SR110-06 at 50 PSI (337µ VMD). Bear in mind, VMD is used for educational purposes only, and should not dictate application.

Quick-Start Example: 10 US G_{PA} @ 14 MPH, on 20" spacing, with a PWM Spray System, applying SYSTEMIC HERBICIDE (glyphosate)

STEP 1: SIZE THE TIP: Focus on Pressure/Speed Range/Duty Cycle (Try maintain 60-80% duty cycle through full speed/pressure range)

For the best option for a tip size, it'd likely be the 110-06 size. (110-05 falls short of nozzle size, and 110-08 starts getting too large)

It would apply 10 US G_{PA}, 14MPH anywhere between 30-60PSI PSI, allowing more than enough room into turn situations if turn compensation is available.

STEP 2: QUALIFY THE SPRAY

Since the chemical label for glyphosate requires a 'even coverage of ASABE COARSE droplets', we will notice the ER110-06 is too fine, the SR fits just right, and the MR/DR are a fair bit coarser than required. We could also use a VMD of 400µ to filter out more.

Note: The MR & DR series are coarser than required, but might be suitable for applicators who have to apply into more drift-sensitive areas.

For this example, we will single out the SR110-06 as our best tip series.

STEP 3: DOUBLE CHECK SR110-06 for max flexibility between

'IDEAL SPRAYING MODE' & 'DRIFT REDUCTION MODE'

Ideal Condition Spraying @ 14MPH:

Drift Sensitive Spraying @ 14MPH:

@50PSI: DUTY CYCLE: 75%  Excellent

@35PSI: DUTY CYCLE: 90%  OK

@50PSI: COARSE Spray Class

@35PSI: VERY COARSE Spray Class

@50PSI % < 141µ: ~9%  Good

@35PSI % < 141µ: ~6%  Excellent

@50PSI % < 600µ: ~90%  Excellent

@35PSI % < 600µ: ~84%  Very Good

Further considerations: Given the high level of coverage at higher pressures (50PSI+), this same nozzle could be used for contact herbicides and fungicides to cover more applications.

Combo Jet® SR110-06
Part No: 40287-06 Color: Gray
Screen No: Not Required

Pressure (psi) ↓	Speed Range (mph) ↓	DC (%) @ 14 mph	Class	VMD (µ)	<141 (µ) (%) ↓	<600 (µ) (%) ↓
25	5.3-11.2	100	XC	466µ	3	76
30	3.6-14.4	97	VC	438µ	5	81
35	3.9-15.6	90	VC	414µ	6	84
40	4.2-16.6	84	C	393µ	7	87
45	4.4-17.6	80	C	375µ	8	88
50	4.7-18.6	75	C	358µ	9	90
55	4.9-19.5	72	C	344µ	10	91
60	5.1-20.4	69	C	330µ	11	92

Picking Nozzles for Dual-tip Spraying

Picking two spray tips isn't much different than a single tip. Since the sprayer has some means of adjust the flow to match a flow rate, simply pick a nozzle size that would supply the full rate, and then divide it into parts that would provide the same flow rate.

For example: If a 110-10 nozzle size is required for an application, suitable pairs would be like a '110-06 + 110-04' or '110-05 + 110-05', as the cumulative size would be able to apply the same rate as a single 110-10. For consistency, limit the size difference to two nozzle sizes to ensure consistent back pressure between both nozzles. (e.g. 110-08 + 110-02 would not be ideal as the -08 might steal flow from the -02)

1 STEP 1: Size Your Tip Since the application rate must be consistent, selecting a tip sized to the required rate over the actual sprayer speed range is critical. It is recommended to use Tip Wizard, as it will adjust the chart specifically for any application rate, not just common pairs of rate & speed.

FOCUS ON: SPEED & PRESSURE for a required APPLICATION RATE

***FOR PWM SPRAYERS (DUTY CYCLE):** Since you have more control of your pressure, your sprayer will typically allow for a wider selection of tip size. Try to pick a size that allows a duty cycle of 60-80% at your typical sprayer speed, allowing sufficient speed up/down.

2 STEP 2: Filter to Your Spray Quality Each chemical will require a nozzle spray quality (for labels that do not, consult chemical representative or agronomist, or general guide based on mode of action), since you have selected your tip size (e.g. 110-04) you can now find the best option within the series available in that nozzle size. The ER/SR/MR/DR/UR series differ based on spray quality & drift reduction.

Example: **MR110-04 + MR110-02**
Spray Quality: **Coarse***

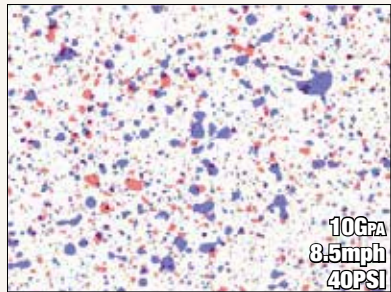

Example: **2x SR110-03**
Spray Quality: **Coarse***

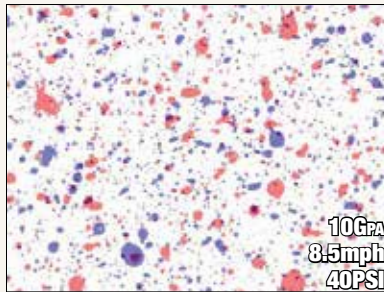

Single Tip Example: **SR110-06**
Spray Quality: **Coarse***

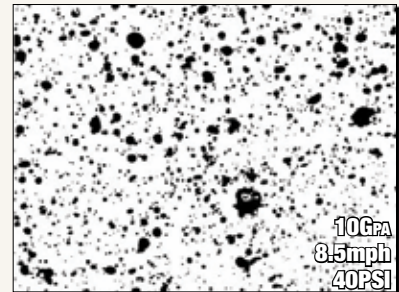

***IMPORTANT: FOR PWM SPRAYERS (Pressure-drop through solenoid):** Depending on the solenoid used, for larger nozzle sizes (or cumulative nozzle sizes for double-down nozzles) there will be greater pressure drop. So, when considering spray quality for the smaller nozzles in a pair, verify the pressure drop for the cumulative size as it will differ from the nozzles individually. With the pressure drop factor, cross-reference the spray quality of the smaller nozzles in the pair for their more realistic spray quality (after pressure drop).

3 STEP 3: Double Check Just like the 'Quick-start guide to picking spray tips', refer to the extra information to qualify nozzles to ensure they will suit your application. Since the pair of nozzles are spraying a fraction of the total weight, there is some synergy between having one as a finer nozzle and the other coarser to produce a more meaningful mix of spray droplet sizes of spray where they need to go.

[ADVANCED] FOCUS ON: Spray % <141µ, Spray % <600µ, VMD (µ)

The extra columns reinforce the different spray qualities between different series, but also give the ability to make a rough spray plan for managing real life spraying conditions.

Spray % <141µ: % of total spray that can be considered driftable fines. If one nozzle is producing more driftable fines than the other, but when averaging based on the flow, you'd want to ensure you are still at a tolerable driftable fines % given the application.

As speed, wind conditions & boom height increase, observed spray drift will increase substantially. This is especially the case with forward/backward facing nozzles.

Spray % <600µ: % of total spray that can be considered small droplets. As % of these useful droplets lowers, coverage is reduced.

Since you are splitting a single 'large' nozzle into two smaller nozzles, you should take advantage of getting a much higher %<600µ than possible with a single nozzle.

VMD (µ): As VMD is the middle point in the distribution of spray, and a pair of nozzles will have a blended VMD when both are considered, simply qualify a tip based on acceptable spray quality first, and take note of the two nozzles and

EXAMPLE: 20 US GPa Glufosinate (Contact Herbicide), on 20" spacing, traveling 12 mph, using a PWM spray system

STEP 1: Using Tip Wizard (or nozzle charts), a 110-125 nozzle size would suffice for travel speed and pressure range. The ER110-125 is shown as an example. With this 110-125 nozzle size, we know a nozzle pair adding to a ~110-125 would be suitable for the application rate. (e.g 110-06 + 110-06)

With this, split the nozzle size into portions and search for a '10 GPa' nozzle and '10GPa' nozzle for example, based on a fraction of total flow.
NOTE: There is extra pressure drop through a solenoid, so keep that in mind when selecting nozzles as the spray quality will differ from nozzles operating by themselves.

Pressure (psi)	Speed Range (mph)	DC (%) @ 12 mph	Class	VMD (µ)	<141 (µ)	<600 (µ)
20	1.8-2.0	100	KC	460µ	7	50
25	2.2-2.5	100	KC	440µ	8	64
30	2.7-3.0	96	KC	420µ	8	68
35	3.4-3.5	89	KC	410µ	9	71
40	3.6-3.8	82	KC	400µ	9	73
45	3.8-3.9	78	KC	390µ	10	75
50	4.0-3.9	74	KC	380µ	10	77
55	4.2-3.9	71	KC	370µ	11	78
60	4.4-3.7	68	VC	360µ	11	79
65	4.6-3.6	65	VC	350µ	11	80

STEP 2: By chemical label, Glufosinate is to be applied as a ASABE medium spray quality or coarser. Qualify spray nozzles suitable for chemical label requirement.

STEP 3: Qualify nozzle pair based on spray quality, and pick based on most suitable % driftable fines (ideally <15%) and % coverage (ideally >90%)

Pressure (psi)	Speed Range (mph)	DC (%) @ 12 mph	Class	VMD (µ)	<141 (µ)	<600 (µ)
25	2.2-2.5	100	KC	440µ	8	64
30	2.7-3.0	100	VC	400µ	8	68
35	3.3-3.0	92	VC	410µ	8	64
40	3.5-3.0	86	C	390µ	7	67
45	3.7-3.0	80	C	370µ	8	68
50	3.9-3.0	77	C	350µ	9	70
55	4.1-3.0	74	C	340µ	10	71
60	4.3-3.0	71	C	330µ	11	72
65	4.5-3.0	68	C	310µ	11	73

Example Result:
Double-Down SR110-06 would provide upwards of 10%+ more volume made of small droplets, without increasing driftable fines.

The spray quality is within the 'coarse' spray quality, just outside MEDIUM spray quality. An ER series could be substituted to provide a mix of even finer spray into the dual nozzle setup.

Total flow would be the same as a 110-12, which would be nominally smaller than a 110-125.

COMBO-JET ER Series Spray Tips

The ER series spray tip is a conventional flat fan nozzle, emphasizing consistent spray pattern with relatively fine spray. All ER nozzles are manufactured with a stainless steel tip.



Longer Lasting Stainless Tips



Less Plugged Nozzles



Perfect for PWM Sprayers



Consistent Pattern at Lower PSI



Solid Mass Spray Droplets



Acid Resistant Nozzles

A DETAILED LOOK AT: **ER110-06**

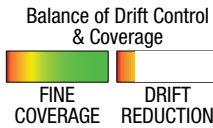

ER110-06 Droplet Distribution Example (40PSI)

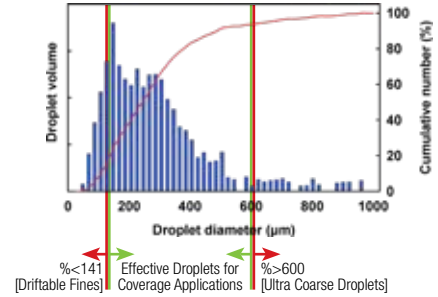

ER series is designed to produce finer spray with a consistent pattern.

COMBO-JET® ER80° ASABE S572.1 Spray Quality Chart

Pressure (psi)	20	25	30	35	40	45	50	60	65	70	80
ER80-01	F	F	F	F	F	F	F	F	F	F	F
ER80-015	F	F	F	F	F	F	F	F	F	F	F
ER80-02	F	F	F	F	F	F	F	F	F	F	F
ER80-025	M	M	F	F	F	F	F	F	F	F	F
ER80-03	M	M	F	F	F	F	F	F	F	F	F
ER80-04	M	M	M	M	M	F	F	F	F	F	F
ER80-05	C	C	M	M	M	M	M	M	M	F	F
ER80-06	C	C	C	C	C	C	M	M	M	M	M
ER80-08	VC	C	C	M	M	M	M	F	F	F	F
ER80-10	XC	XC	XC	VC	C	C	C	M	M	M	F
ER80-125		XC	XC	VC	VC	C	C	C	C	C	M
ER80-15		XC	XC	XC	VC	C	C	C	M	M	M
ER80-20		UC	XC	XC	XC	XC	VC	C	C	C	C
ER80-25		UC	XC	XC	XC	VC	VC	C	C	C	C
ER80-30		UC	UC	XC	XC	XC	XC	XC	XC	VC	VC
ER80-40				XC	XC	XC	XC	XC	XC	XC	VC
ER80-50				XC	XC	XC	XC	XC	XC	XC	VC
ER80-60				XC	XC	XC	XC	XC	XC	XC	VC

COMBO-JET® ER Series Specifications
Approved for PWM Spray Systems Compatible with all PWM Spray systems/Hz.
Operating Pressure 20-100PSI
Flat Fan Nozzle Type Conventional Flat Fan
Nozzle Materials Spray Tip: Stainless Steel O-ring: FKM, 13mm x 3mm #40260-00 (viton avail.) Cap: Glass-reinforced Polypropylene

ASABE Spray Classification
(ASABE S572.1 Standard) Spray quality is categorized based on Dv0.1 and VMD droplet sizes. Objective testing data (by 3rd party), from spray spectrum recording equipment (without wind tunnel use), has been used to classify spray quality for this chart. Chart shown includes spray quality at tested data points as well as extrapolated data points.
<ul style="list-style-type: none"> ■ Fine (F) ■ Medium (M) ■ Coarse (C) ■ Very Coarse (VC) ■ Extremely Coarse (XC) ■ Ultra Coarse (UC)
Tips sized up to 110-06 verified on Phase Doppler Particle Analyzer (PDPA); tips sized over 110-06 verified on Malvern.

COMBO-JET® ER110° ASABE S572.1 Spray Quality Chart

Pressure (psi)	20	25	30	35	40	45	50	60	65	70	80
ER110-01	F	F	F	F	F	F	F	F	F	F	F
ER110-015	F	F	F	F	F	F	F	F	F	F	F
ER110-02	F	F	F	F	F	F	F	F	F	F	F
ER110-025	F	F	F	F	F	F	F	F	F	F	F
ER110-03	F	F	F	F	F	F	F	F	F	F	F
ER110-04	M	M	M	M	F	F	F	F	F	F	F
ER110-05	M	M	M	M	F	F	F	F	F	F	F
ER110-06	C	M	M	M	M	M	M	M	M	F	F
ER110-08	C	C	C	M	M	M	M	F	F	F	F
ER110-10	VC	C	C	C	C	C	M	M	M	M	F
ER110-125		XC	XC	XC	VC	VC	C	C	C	C	C
ER110-15		XC	XC	XC	VC	VC	C	C	C	C	C
ER110-20		XC	XC	XC	XC	XC	XC	VC	VC	C	C
ER110-25		XC	XC	XC	XC	XC	XC	VC	VC	C	C
ER110-30		UC	XC	XC	XC	XC	XC	XC	XC	XC	VC

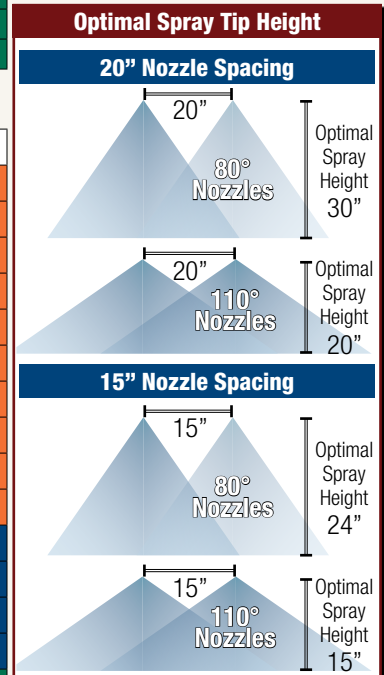

COMBO-JET SR Series Spray Tips

The SR series spray tip is a closed-chamber, pre-orifice drift reduction nozzle, emphasizing a first stage of drift reduction. The SR series balances excellent coverage spray with significant drift reduction upwards of 50%+.



Longer Lasting Stainless Tips



Less Plugged Nozzles



Perfect for PWM Sprayers



Consistent Pattern at Lower PSI



Solid Mass Spray Droplets



Acid Resistant Nozzles

A DETAILED LOOK AT: **SR110-06**



Balance of Drift Control & Coverage



FINE COVERAGE



DRIFT REDUCTION

SR110-06 Droplet Distribution Example (40psi)

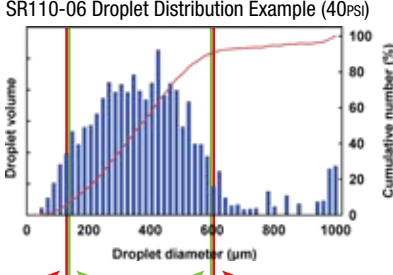

SR series droplet distribution balances excellent fine spray coverage while reducing driftable fines.

COMBO-JET® SR80° ASABE S572.1 Spray Quality Chart

Pressure (psi)	25	30	35	40	45	50	60	65	70	80
SR80-01	M	M	F	F	F	F	F	F	F	F
SR80-015	C	M	M	M	M	F	F	F	F	F
SR80-02	C	M	M	M	M	M	F	F	F	F
SR80-025	C	C	C	M	M	M	M	M	M	F
SR80-03	C	C	C	C	C	C	M	M	M	M
SR80-04	C	C	C	C	C	C	C	M	M	M
SR80-05	VC	VC	C	C	C	C	C	C	C	C
SR80-06	XC	VC	VC	VC	C	C	C	C	C	C
SR80-08	UC	UC	UC	UC	XC	XC	XC	XC	XC	XC
SR80-10	UC	UC	UC	UC	UC	UC	XC	XC	XC	XC
SR80-125	UC	UC	UC	UC	UC	UC	UC	XC	XC	XC
SR80-15	UC	UC	UC	UC	UC	UC	UC	UC	UC	UC
SR80-20		UC	UC	UC	UC	UC	UC	UC	UC	UC
SR80-25		UC	UC	UC	UC	UC	UC	UC	UC	UC
SR80-30		UC	UC	UC	UC	UC	UC	UC	UC	UC

COMBO-JET® SR Series Specifications

Approved for PWM Spray Systems
Compatible with all PWM Spray systems/Hz.

Operating Pressure
25-100PSI

Flat Fan Nozzle Type
Closed-Chamber, Pre-Orifice Drift Reduction

Nozzle Materials
Spray Tip: Stainless Steel
O-ring: FKM, 13mm x 3mm #40260-00 (viton avail.)
Cap: Glass-reinforced Polypropylene

ASABE Spray Classification

(ASABE S572.1 Standard)
Spray quality is categorized based on Dv0.1 and VMD droplet sizes. Objective 3rd party testing data, from spray spectrum recording equipment (without wind tunnel use), has been used to classify spray quality for this chart. Chart shown includes spray quality at tested data points as well as extrapolated data points.

■ Fine (F)
■ Medium (M)
■ Coarse (C)

■ Very Coarse (VC)
■ Extremely Coarse (XC)
■ Ultra Coarse (UC)

Tips sized up to 110-06 verified on Phase Doppler Particle Analyzer (PDPA); tips sized over 110-06 verified on Malvern.

COMBO-JET® SR110° ASABE S572.1 Spray Quality Chart

Pressure (psi)	25	30	35	40	45	50	60	65	70	80
SR110-015	M	F	F	F	F	F	F	F	F	F
SR110-02	M	M	F	F	F	F	F	F	F	F
SR110-025	M	M	M	M	M	F	F	F	F	F
SR110-03	C	C	C	C	M	M	M	M	M	F
SR110-04	C	C	C	C	C	M	M	M	M	M
SR110-05	C	C	C	C	C	C	C	M	M	M
SR110-06	VC	VC	C	C	C	C	C	C	C	M
SR110-08	UC	XC	XC	XC	XC	VC	C	C	C	C
SR110-10	UC	XC	XC	XC	XC	XC	VC	C	C	C
SR110-125	UC	UC	XC	XC	XC	XC	XC	VC	C	C
SR110-15	UC	UC	UC	UC	XC	XC	XC	XC	XC	XC
SR110-20		UC	UC	XC	XC	XC	XC	XC	XC	XC
SR110-25		UC	UC	XC	XC	XC	XC	XC	XC	XC

Optimal Spray Tip Height

15" Nozzle Spacing

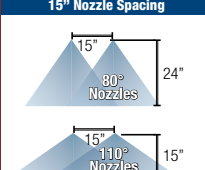

20" Nozzle Spacing

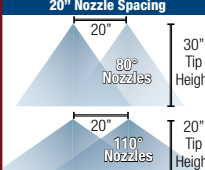

LERAP Ratings for SR Series

As of January 2021

SR110-05

★★★★ 75%
☆☆☆ 50%
 1.0-1.5BAR 1.6-3.0BAR

For the updated list of nozzles, visit www.wilger.net/LERAP
 More information on LERAP certification, process, and the most up to date listing of approved nozzles and their ratings, is available from the Health and Safety Executive (HSE), also available online @ <https://secure.pesticides.gov.uk/SprayEquipment>

COMBO-JET® SR Pre-orifices - by nozzle size [Replacement Only]

-01	-015	-02	-025	-03	-04	-05	-06	-08	-10	-125	-15	-20	-25	-30
40285-01	40285-015	40285-01	40285-025	40285-03	40285-04	40285-05	40285-06	40285-08	40285-10	40285-125	40285-15	40285-20	40285-25	40285-30

COMBO-JET MR Series Spray Tips

The MR series spray tip is a closed-chamber, pre-orifice drift reduction nozzle, emphasizing a second stage of drift reduction. The MR series balances great coverage spray with significant drift reduction upwards of 75%+.



Longer Lasting Stainless Tips



Superior Drift Reduction



Perfect for PWM Sprayers



Consistent Pattern at Lower PSI



Solid Mass Spray Droplets



Acid Resistant Nozzles

A DETAILED LOOK AT: **MR110-06**



Balance of Drift Control & Coverage



MR110-06 Droplet Distribution Example (40psi)

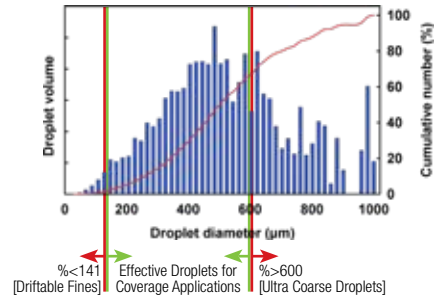

MR series is designed to produce relatively coarse spray with minimal drift.

COMBO-JET® MR80° ASABE S572.1 Spray Quality Chart

Pressure (psi)	30	35	40	45	50	60	65	70	80
MR80-005	M	M	F	F	F	F	F	F	F
MR80-0067	F	F	F	F	F	F	F	F	F
MR80-01	M	F	F	F	F	F	F	F	F
MR80-015	C	C	C	M	M	M	M	M	F
MR80-02	C	C	C	C	C	M	M	M	M
MR80-025	VC	VC	C	C	C	C	C	C	C
MR80-03	VC	VC	C	C	C	C	C	C	C
MR80-04	VC	VC	C	C	C	C	C	C	C
MR80-05	XC	XC	VC	VC	VC	VC	C	C	C
MR80-06	XC	XC	XC	XC	VC	VC	VC	VC	C
MR80-08	UC	UC	UC	UC	XC	XC	XC	XC	VC
MR80-10	UC	UC	UC	UC	UC	XC	XC	XC	XC
MR80-125	UC	UC	UC	UC	UC	UC	UC	XC	XC
MR80-15	UC	UC	UC	XC	XC	XC	XC	XC	VC
MR80-20		UC	UC	UC	UC	XC	XC	XC	XC
MR80-25		UC	UC	UC	UC	UC	UC	UC	UC
MR80-30		UC	UC	UC	UC	UC	UC	UC	UC
MR80-40		UC	UC	UC	UC	XC	XC	XC	XC

COMBO-JET® MR110° ASABE S572.1 Spray Quality Chart

Pressure (psi)	30	35	40	45	50	60	65	70	80
MR110-015	C	C	C	M	M	M	F	F	F
MR110-02	C	C	C	M	M	M	M	M	F
MR110-025	C	C	C	C	C	C	M	M	M
MR110-03	VC	C	C	C	C	C	C	C	C
MR110-04	VC	VC	C	C	C	C	C	C	C
MR110-05	XC	XC	VC	VC	VC	C	C	C	C
MR110-06	XC	XC	XC	VC	VC	VC	VC	VC	C
MR110-08	UC	UC	UC	XC	XC	XC	XC	XC	VC
MR110-10	UC	UC	XC	XC	XC	XC	XC	XC	VC
MR110-125	UC	UC	UC	UC	UC	UC	UC	UC	UC
MR110-15	UC	UC	UC	UC	UC	UC	UC	UC	UC
MR110-20		UC	UC	UC	UC	UC	UC	UC	XC

COMBO-JET® MR Pre-orifices - by size [Replacement Only]

-005	-0067	-01	-015	-02	-025	-03	-04	-05	-06	-08	-10	-125	-15	-20	-25	-30	-40
40285-005	40285-007	40285-01	40285-015	40285-01	40285-025	40285-03	40285-04	40285-05	40285-06	40285-08	40285-10	40285-125	40285-15	40285-20	40285-25	40285-30	40285-40

COMBO-JET® MR Series Specifications

Approved for PWM Spray Systems
Compatible with all PWM Spray systems/Hz.

Operating Pressure

30-100PSI

Flat Fan Nozzle Type
Closed-Chamber, Pre-Orifice Drift Reduction

Nozzle Materials
Spray Tip: Stainless Steel
Repl.O-ring: FKM, 13mm x 3mm #40260-00 (viton avail)
Cap: Glass-reinforced Polypropylene

ASABE Spray Classification

(ASABE S572.1 Standard)
Spray quality is categorized based on Dv0.1 and VMD droplet sizes. Objective 3rd party testing data, from spray spectrum recording equipment (without wind tunnel use), has been used to classify spray quality for this chart. Chart shown includes spray quality at tested data points as well as extrapolated data points.

- Fine (F)
- Medium (M)
- Coarse (C)
- Very Coarse (VC)
- Extremely Coarse (XC)
- Ultra Coarse (UC)

Tips sized up to 110-06 verified on Phase Doppler Particle Analyzer (PDPA); tips sized over 110-06 verified on Malvern.

Optimal Spray Tip Height

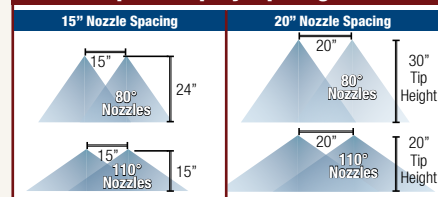

LERAP Ratings for MR Series As of January 2021

MR110-04	★★★★ 75%	☆☆ 50%
	1.0-2.5BAR	2.6-3.5BAR
MR110-05	☆☆☆☆ 90%	★★★★ 75%
	1.0-1.5BAR	1.6-5.0BAR
MR110-06	☆☆☆☆ 90%	★★★★ 75%
	1.0-1.5BAR	1.6-5.0BAR

For the updated list of nozzles, visit www.wilger.net/LERAP
More information on LERAP certification, process, and the most up to date listing of approved nozzles and their ratings, is available from the Health and Safety Executive (HSE), also available online @ <https://secure.pesticides.gov.uk/SprayEquipment>

JKI Nozzle Ratings for MRs Visit www.wilger.net for updated charts

COMBO-JET DR Series Spray Tips

The DR series spray tip is a closed-chamber, pre-orifice drift reduction nozzle, emphasizing a third stage of drift reduction. The DR series balances good coverage spray with extremely low driftable fines, upwards of a 90% reduction in driftable fines.



Longer Lasting Stainless Tips



Superior Drift Reduction



Perfect for PWM Sprayers



Consistent Pattern at Lower PSI



Solid Mass Spray Droplets



Acid Resistant Nozzles

A DETAILED LOOK AT: **DR110-06**



Balance of Drift Control & Coverage

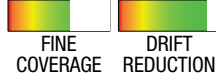

DR110-06 Droplet Distribution Example (40psi)

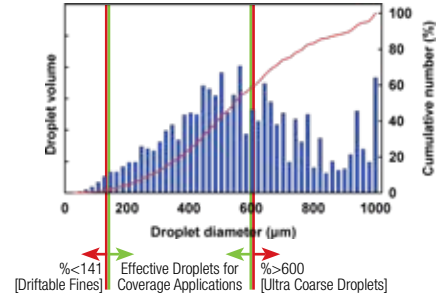

DR series is designed to produce extremely coarse spray with very minimal drift.

COMBO-JET® DR80° ASABE S572.1 Spray Quality Chart

Pressure (psi)	30	35	40	45	50	60	65	70	80
DR80-005	C	M	M	F	F	F	F	F	F
DR80-0067	C	C	M	M	M	M	F	F	F
DR80-01	C	C	C	M	M	M	M	F	F
DR80-015	VC	VC	C	C	C	C	C	C	C
DR80-02	XC	VC	VC	VC	VC	C	C	C	C
DR80-025	XC	VC	VC	VC	VC	C	C	C	C
DR80-03	XC	XC	VC	VC	VC	C	C	C	C
DR80-04	XC	XC	XC	XC	XC	XC	VC	VC	C
DR80-05	XC	XC	XC	XC	XC	XC	XC	VC	VC
DR80-06	XC	XC	XC	XC	XC	XC	XC	XC	XC
DR80-08	UC	UC	UC	UC	UC	UC	UC	UC	UC
DR80-10	UC	UC	UC	UC	UC	UC	UC	UC	UC
DR80-125	UC	UC	UC	UC	UC	UC	UC	UC	UC
DR80-15	UC	UC	UC	UC	UC	UC	UC	UC	UC
DR80-20		UC	UC	UC	UC	UC	UC	UC	UC
DR80-25		UC	UC	UC	UC	UC	UC	UC	UC
DR80-30		UC	UC	UC	UC	UC	UC	UC	XC

COMBO-JET® DR110° ASABE S572.1 Spray Quality Chart

Pressure (psi)	30	35	40	45	50	60	65	70	80
DR110-015	C	C	C	C	C	C	C	M	M
DR110-02	VC	VC	VC	C	C	C	C	C	C
DR110-025	VC	VC	VC	C	C	C	C	C	C
DR110-03	XC	XC	VC	VC	VC	C	C	C	C
DR110-04	XC	XC	VC	VC	VC	VC	C	C	C
DR110-05	XC	XC	XC	XC	XC	XC	XC	VC	VC
DR110-06	XC	XC	XC	XC	XC	XC	XC	XC	VC
DR110-08	UC	UC	UC	UC	UC	UC	UC	UC	XC
DR110-10	UC	UC	UC	UC	UC	UC	UC	UC	UC
DR110-125	UC	UC	UC	UC	UC	UC	UC	UC	UC
DR110-15	UC	UC	UC	UC	UC	UC	UC	UC	UC

COMBO-JET® DR Pre-orifices - by tip size [Replacement Only]

-005	-0067	-01	-015	-02	-025	-03	-04	-05	-06	-08	-10	-125	-15	-20	-25	-30
40285-005	40285-007	40285-01	40285-015	40285-01	40285-025	40285-03	40285-04	40285-05	40285-06	40285-08	40285-10	40285-125	40285-15	40285-20	40285-25	40285-30

COMBO-JET® DR Series Specifications

Approved for PWM Spray Systems
Compatible with all PWM Spray systems/Hz.

Operating Pressure
30-100PSI

Flat Fan Nozzle Type
Closed-Chamber, Pre-Orifice Drift Reduction

Nozzle Materials
Spray Tip: Stainless Steel
Repl.O-ring: FKM, 13mm x 3mm #40260-00 (viton avail)
Cap: Glass-reinforced Polypropylene

ASABE Spray Classification

(ASABE S572.1 Standard)
Spray quality is categorized based on Dv0.1 and VMD droplet sizes. Objective 3rd party testing data, from spray spectrum recording equipment (without wind tunnel use), has been used to classify spray quality for this chart. Chart shown includes spray quality at tested data points as well as extrapolated data points.

- Fine (F)
- Medium (M)
- Coarse (C)
- Very Coarse (VC)
- Extremely Coarse (XC)
- Ultra Coarse (UC)

Tips sized up to 110-06 verified on Phase Doppler Particle Analyzer (PDPA); tips sized over 110-06 verified on Malvern.

Optimal Spray Tip Height

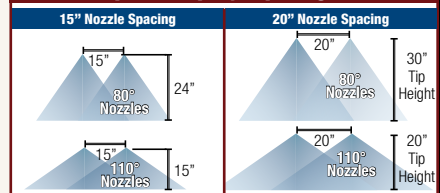

LERAP Ratings for DR Series As of January 2021

DR110-025	★★★★ 75%	☆☆ 50%	1.0-2.5BAR	2.6-3.5BAR		
DR110-03	☆☆☆☆ 90%	★★★★ 75%	☆☆ 50%	1.0-1.5BAR	1.6-2.5BAR	2.6-3.5BAR
DR110-04	★★★★ 75%		1.0-5.0BAR			
DR110-05	☆☆☆☆ 90%	★★★★ 75%	1.0-1.5BAR	1.6-5.0BAR		
DR110-06	☆☆☆☆ 90%	★★★★ 75%	1.0-3.0BAR	3.1-5.0BAR		

For the updated list of nozzles, visit www.wilger.net/LERAP
More information on LERAP certification, and the most up to date listing of tested nozzles, visit <https://secure.pesticides.gov.uk/SprayEquipment>

JKI Nozzle Ratings for DR Series Visit www.wilger.net for updated charts

COMBO-JET UR Series* Spray Tips

*U.S. Patent No. 10,603,681

The UR series spray tip is a dual-chamber, pre-orifice drift reduction nozzle, emphasizing the coarsest stage of drift reduction. The UR series is heavily suited to ultra-low driftable fines, emphasizing drift reduction over coverage.



Approved for Dicamba Mixes



Ultra Low Spray Drift



Perfect for PWM Sprayers



Longer Lasting Stainless Tips



Solid Mass Spray Droplets



Acid Resistant Nozzles

A DETAILED LOOK AT: **UR110-06**



Balance of Drift Control & Coverage



UR110-06 Droplet Distribution Example (60psi)

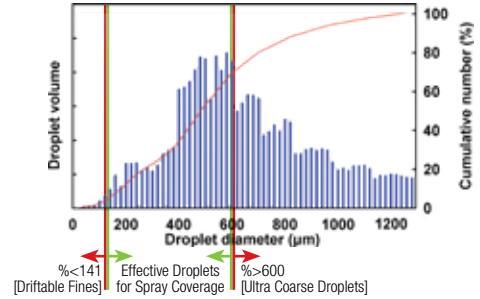

UR series is designed to produce ultra coarse spray with extremely little drift.

COMBO-JET® UR110° ASABE S572.1 Spray Quality Chart

Pressure (psi)	35	40	45	50	60	65	70	80
UR110-025	UC	UC	UC	UC	XC	XC	XC	XC
UR110-03	UC	UC	UC	UC	XC	XC	XC	XC
UR110-04	UC	UC	UC	UC	UC	UC	UC	UC
UR110-05	UC	UC	UC	UC	UC	UC	UC	UC
UR110-06	UC	UC	UC	UC	UC	UC	UC	UC
UR110-08	UC	UC	UC	UC	UC	UC	UC	UC
UR110-10	UC	UC	UC	UC	UC	UC	UC	UC

COMBO-JET® UR Series Specifications

Approved for PWM Spray Systems
Compatible with all PWM Spray systems/Hz.

Operating Pressure
35-100PSI

Flat Fan Nozzle Type
Dual Closed-Chamber, Pre-Orifice Drift Reduction

Nozzle Materials
Spray Tip: Stainless Steel
Repl.O-ring: FKM, 13mm x 3mm #40260-00 (viton avail)
Cap: Glass-reinforced Polypropylene

ASABE Spray Classification

(ASABE S572.1 Standard)
Spray quality is categorized based on Dv0.1 and VMD droplet sizes. Objective 3rd party testing data, from spray spectrum recording equipment (without wind tunnel use), has been used to classify spray quality for this chart. Chart shown includes spray quality at tested data points as well as extrapolated data points.

- Fine (F)
- Medium (M)
- Coarse (C)
- Very Coarse (VC)
- Extremely Coarse (XC)
- Ultra Coarse (UC)

UR Nozzles verified on Malvern.

COMBO-JET® UR Series* Pre-orifice Sets [Replacement only]

UR two-piece pre-orifices must be replaced with a new pair only. Correct orifices must be used for proper performance.

-025	-03	-04	-05	-06	-08	-10
40292-22	40292-23	40292-24	40292-25	40292-26	40292-28	40292-30

*U.S. Patent No. 10,603,681

JKI Ratings for UR Series

As of January 2021

UR110-04	75% 2.0-3.0BAR REF. G-2184	50% 4.0-6.0BAR REF. G-2184
UR110-05	90% 2.0BAR REF. G-2185	75% 3.0-6.0BAR REF. G-2185
UR110-06	90% 2.0-3.0BAR REF. G-2189	75% 4.0-6.0BAR REF. G-2189

Optimal Spray Tip Height

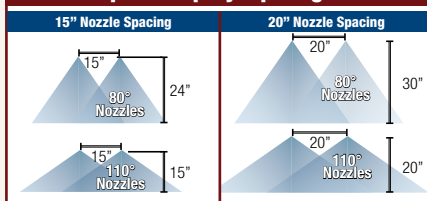

COMBO-JET 80° Spray Tips - Standard Sprayer Systems

Comprehensive rate & speed charts for any nozzle spacing/speed/rate is available on Tip Wizard. Try it today!

⚠ Disclaimer: These charts are published for comparative purposes to demonstrate the differences in the series of Combo-Jet® spray tips. Data used to populate this chart is extrapolated from third party testing data from a controlled conditions test with water as the testing solution. Actual spray applications with active chemical ingredients may change the spray dynamics and spray tip performance specifications. Wilger is not liable for any misuse or misrepresentation of this information, leading to (but not limited to) incorrect spray application, crop damage, or any other harm. (Not limited to human, livestock or environmental). Always verify these charts with the most recent charts found on the www.wilger.net, and ALWAYS follow chemical label nozzle requirements.

Nozzle Size & Angle	Flow Rate USGPM	PSI	Application Rate in US Gallons/Acre on 20" Nozzle Spacing								Spray Classification; VMD (Droplet Size in μ); %<141μ (Drift %); %<600μ (Small Droplets)															
			@ Sprayer Speed - Miles / Hour								ER80° Series				SR80° Series				MR80° Series				DR80° Series			
			Sprayer Speed (on 20" spacing) @								Class	VMD	<141	<600	Class	VMD	<141	<600	Class	VMD	<141	<600	Class	VMD	<141	<600
80-005 Nozzles	Flow us gpm	Boom psi	Sprayer Speed (on 20" spacing) @								ER80-005	#40270-005			SR80-005	#40288-005			MR80-005	#40290-005			DR80-005	#40280-005		
	20	5.3	2.6	3.5	4.4	5.3	6.2	7.1	8.0	F	167	33%	100%													
	25	5.9	3.9	2.9	2.3	2.0	1.7	1.5	1.3	F	157	40%	100%					M	261	11%	99%	C	311	6%	100%	
	30	6.4	4.3	3.2	2.6	2.1	1.8	1.6	1.4	F	149	46%	100%					M	236	17%	98%	C	276	11%	100%	
	35	6.9	4.6	3.5	2.8	2.3	2.0	1.7	1.5	F	142	51%	100%					M	217	22%	97%	C	250	16%	100%	
	40	7.4	5.0	3.7	3.0	2.5	2.1	1.9	1.7	F	137	55%	100%					F	201	26%	96%	M	230	19%	100%	
	45	7.9	5.3	3.9	3.2	2.6	2.3	2.0	1.8	F	132	59%	100%					F	189	30%	95%	F	213	23%	100%	
	50	8.3	5.5	4.2	3.3	2.8	2.4	2.1	1.9	F	128	63%	100%					F	178	33%	94%	F	200	25%	100%	
	55	8.7	5.7	4.5	3.6	3.0	2.6	2.3	2.0	F	124	67%	100%					F	167	36%	93%	F	188	28%	100%	
	60	9.1	6.1	4.5	3.6	3.0	2.6	2.3	2.0	F	121	68%	100%					F	161	39%	93%	F	178	30%	100%	
80-0067 Nozzles	Flow us gpm	Boom psi	Sprayer Speed (on 20" spacing) @								ER80-0067	#40270-0067			SR80-0067	#40288-0067			MR80-0067	#40290-0067			DR80-0067	#40280-0067		
	20	7.0	4.7	3.5	2.8	2.3	2.0	1.8	1.6	F	199	21%	100%													
	25	7.9	5.2	3.9	3.1	2.6	2.2	2.0	1.8	F	183	29%	100%					M	231	18%	99%	C	337	6%	100%	
	30	8.6	5.7	4.3	3.4	2.9	2.5	2.2	2.0	F	171	35%	100%					F	211	24%	98%	C	308	9%	100%	
	35	9.3	6.2	4.7	3.7	3.1	2.7	2.3	2.1	F	161	40%	100%					F	195	29%	97%	C	285	11%	100%	
	40	9.9	6.6	5.0	4.0	3.3	2.8	2.5	2.3	F	153	45%	100%					F	182	33%	96%	M	267	13%	100%	
	45	11.0	7.0	5.3	4.2	3.5	3.0	2.6	2.4	F	147	49%	100%					F	171	37%	95%	M	252	15%	100%	
	50	11.0	7.4	5.6	4.4	3.7	3.2	2.8	2.6	F	141	52%	100%					F	162	40%	94%	M	239	17%	100%	
	55	12.0	8.1	6.1	4.9	4.1	3.5	3.0	2.7	F	131	58%	100%					F	148	46%	93%	M	218	20%	100%	
	60	13.0	8.5	6.3	5.1	4.2	3.6	3.2	2.9	F	128	61%	100%					F	142	49%	92%	F	210	21%	100%	
80-01 Nozzles	Flow us gpm	Boom psi	Sprayer Speed (on 20" spacing) @								ER80-01	#40270-01			SR80-01	#40288-01			MR80-01	#40290-01			DR80-01	#40280-01		
	20	5.3	4.2	3.5	2.8	2.6	2.3	2.1	1.9	F	175	29%	100%													
	25	5.9	4.7	3.9	3.1	2.9	2.6	2.3	2.1	F	164	35%	100%	M	258	15%	97%									
	30	6.4	5.1	4.3	3.4	3.2	2.9	2.6	2.4	F	156	41%	100%	M	233	21%	97%	M	218	23%	97%	C	312	10%	94%	
	35	6.9	5.6	4.6	3.7	3.5	3.1	2.8	2.6	F	149	45%	100%	F	214	25%	97%	F	204	27%	97%	C	291	12%	95%	
	40	7.4	5.9	5.0	4.0	3.7	3.3	3.0	2.7	F	143	49%	100%	F	199	29%	97%	F	191	30%	97%	C	274	14%	96%	
	45	7.9	6.3	5.3	4.2	3.9	3.5	3.2	2.9	F	139	53%	100%	F	186	33%	97%	F	181	33%	97%	M	260	15%	97%	
	50	8.3	6.6	5.5	4.4	4.2	3.7	3.3	3.0	F	134	56%	100%	F	176	36%	98%	F	173	36%	97%	M	248	17%	98%	
	55	9.1	7.3	6.1	4.8	4.5	4.0	3.6	3.3	F	128	62%	100%	F	159	41%	98%	F	159	40%	97%	M	229	19%	99%	
	60	9.5	7.6	6.3	5.0	4.7	4.2	3.8	3.5	F	125	64%	100%	F	152	44%	98%	F	153	42%	97%	M	221	20%	100%	
80-015 Nozzles	Flow us gpm	Boom psi	Sprayer Speed (on 20" spacing) @								ER80-015	#40270-015			SR80-015	#40288-015			MR80-015	#40290-015			DR80-015	#40280-015		
	20	7.9	6.3	5.3	4.2	3.9	3.2	2.6	2.4	F	199	21%	100%													
	25	8.8	7.0	5.9	4.7	4.4	3.5	2.9	2.7	F	188	25%	100%	C	286	13%	94%									
	30	9.6	7.7	6.4	5.1	4.8	3.9	3.2	3.0	F	180	29%	100%	M	262	16%	95%	C	323	10%	94%	VC	418	4%	87%	
	35	10.0	8.3	6.9	5.6	5.2	4.2	3.5	3.3	F	173	32%	100%	M	244	19%	96%	C	301	12%	95%	VC	397	5%	89%	
	40	11.0	8.9	7.4	5.9	5.6	4.5	3.7	3.5	F	167	34%	100%	M	230	22%	96%	C	283	14%	96%	C	380	6%	90%	
	45	12.0	9.5	7.9	6.3	5.9	4.7	3.9	3.7	F	162	37%	100%	M	218	24%	97%	M	269	16%	97%	C	365	6%	91%	
	50	12.0	10.0	8.3	6.6	6.2	5.0	4.2	4.0	F	158	39%	100%	F	207	26%	97%	M	256	17%	97%	C	353	7%	92%	
	55	13.0	11.0	9.1	7.3	6.8	5.5	4.5	4.3	F	151	42%	100%	F	191	30%	97%	M	236	20%	98%	C	332	8%	94%	
	60	14.0	11.0	9.5	7.6	7.1	5.7	4.7	4.5	F	148	44%	100%	F	184	32%	97%	M	227	21%	98%	C	324	8%	94%	
80-02 Nozzles	Flow us gpm	Boom psi	Sprayer Speed (on 20" spacing) @								ER80-02	#40270-02			SR80-02	#40288-02			MR80-02	#40290-02			DR80-02	#40280-02		
	20	8.4	7.0	5.6	5.3	4.2	3.5	2.8	2.6	F	184	28%	100%													
	25	9.4	7.8	6.3	5.9	4.7	3.9	3.1	2.9	F	176	31%	100%	C	273	13%	94%									
	30	10	8.6	6.9	6.4	5.1	4.3	3.4	3.2	F	170	34%	100%	M	257	16%	95%	C	326	8%	94%	XC	454	3%	80%	
	35	11	9.3	7.4	6.9	5.6	4.6	3.7	3.5	F	166	36%	100%	M	244	18%	96%	C	310	10%	94%	VC	435	4%	83%	
	40	12	9.9	7.9	7.4	5.9	5.0	4.0	3.8	F	161	38%	100%	M	233	20%	96%	C	298	11%	94%	VC	419	4%	84%	
	45	13	11.0	8.4	7.9	6.3	5.3	4.2	4.0	F	158	40%	100%	M	224	22%	97%	C	287	13%	94%	VC	406	5%	86%	
	50	13	11.0	8.9	8.3	6.6	5.5	4.4	4.2	F	155	42%	100%	M	216	24%	97%	C	277	14%	95%	VC	394	5%	87%	
	55	15	12.0	9.7	9.1	7.3	6.1	4.8	4.6	F	150	45%	100%	F	203	27%	98%	M	262	16%	95%	C	375	6%	88%	
	60	15	13.0	10.0	9.5	7.6	6.3	5.0	4.8	F	147	46%	100%	F	198	29%	98%	M	255	17%	95%	C	366	6%	89%	
80-025 Nozzles	Flow us gpm	Boom psi	Sprayer Speed (on 20" spacing) @								ER80-025	#40270-025			SR80-025	#40288-025			MR80-025	#40290-025			DR80-025	#40280-025		
	20	11	8.8	7.0	6.6	5.3	4.4	3.5	3.3	M	232	17%	100%													
	25	12	9.8	7.8	7.3	5.9	4.9	3.9	3.7	M	219	21%	100%	C	315	9%	91%									
	30	13	11.0	8.6	8.0	6.4	5.4	4.3	4.1	F	209	23%	100%	C	296	11%	93%	VC	425	5%	81%	XC	460	3%	77%	
	35	14	12.0	9.3	8.7	6.9	5.8	4.6	4.4	F	200	26%	100%	C	281	13%	94%	VC	401	6%	83%	VC	443	4%	79%	
	40	15	12.0	9.9	9.3	7.4	6.2	5.0	4.8	F	194	28%	100%	M	268	15%	94%	C	382	6%	85%	VC	430	4%	81%	
	45	16	13	11.0	9.8	7.9	6.6	5.3	5.1	F	188	30%	100%	M	257	17%	95%	C	367	7%	86%	VC	418	5%	82%	
	50	17	14	11.0	10.0	8.3	6.9	5.5	5.3	F	182	31%	100%	M	248	18%	95%	C	353	8%	87%	VC	408	5%	83%	
	55	18	15	12.0	11.0	9.1	7.6	6.1	5.9	F	174	34%	100%	M	233	20%	96%	C	330	9%	89%	C	391	6%	85%	
	60	19	16	13.0	12.0	9.5	7.9	6.3	6.1	F	170	36%	100%	M	226	21%	96%	C	321	10%	89%	C	383	6%	85%	

NOTE: *SR, MR, DR, UR spray tips include pre-orifice(s). Pre-orifices are not interchangeable between different spray tips of different series. *Shown application information is based on water @ 80°F in a controlled environment and should not be considered actual. Information is provided for comparison to other Combo-Jet® spray tips, for educational purposes only. Repeat testing results can vary.

COMBO-JET 80° Spray Tips - Standard Sprayer Systems

Comprehensive rate & speed charts for any nozzle spacing/speed/rate is available on Tip Wizard. Try it today!

<p>ASABE Spray Classification (ASABE S572.1 Standard) Spray quality is categorized based on Dv0.1 and VMD droplet sizes. Objective testing data (by 3rd party), from spray spectrum recording equipment (without wind tunnel use), has been used to classify spray quality for this chart. Extra data (e.g. VMD, etc.) can vary between testing equipment and method, and is provided as an educational resource only. <small>Tips sized up to 110-06 verified on Phase Doppler Particle Analyzer (PDPA); tips sized over 110-06 verified on Malvern.</small></p>	<ul style="list-style-type: none"> ■ Fine (F) ■ Medium (M) ■ Coarse (C) ■ Very Coarse (VC) ■ Extremely Coarse (XC) ■ Ultra Coarse (UC) 	<p>VMD (Volume Median Diameter) The median droplet (in μ) for a sprayed volume. Half of the volume is made of droplets smaller, with half made up of droplets larger.</p>	<p>% <141μ (% Driftable Fines) Percentage of volume which is likely to drift. As wind & boom height increase, observed spray drift will increase substantially.</p>	<p>% <600μ (% of Small Droplets) % of volume which is made up of 'small' droplets, useful for coverage. As % of useful droplets lowers, overall coverage is reduced.</p>
---	---	---	--	---

	Flow us gpm	Boom psi	Sprayer Speed (on 20" spacing) @							ER80-03		#40270-03		SR80-03		#40288-03		MR80-03		#40290-03		DR80-03		#40280-03	
			5GPA	6GPA	7.5	8GPA	10GPA	12GPA	15GPA	Class	VMD	<141	<600	Class	VMD	<141	<600	Class	VMD	<141	<600	Class	VMD	<141	<600
80-03 Nozzles	0.21	20	13	11.0	8.4	7.9	6.3	5.3	4.2	M	233	17%	99%												
	0.24	25	14	12.0	9.4	8.8	7.0	5.9	4.7	M	222	20%	99%	C	368	7%	88%								
	0.26	30	15	13	10.0	9.6	7.7	6.4	5.1	F	214	23%	99%	C	344	9%	89%	VC	432	5%	81%	XC	481	3%	72%
	0.28	35	17	14	11.0	10.0	8.3	6.9	5.6	F	207	25%	99%	C	325	11%	90%	VC	409	6%	83%	XC	462	4%	75%
	0.30	40	18	15	12.0	11.0	8.9	7.4	5.9	F	201	26%	99%	C	309	12%	91%	C	390	7%	85%	VC	447	4%	77%
	0.32	45	19	16	13.0	12.0	9.5	7.9	6.3	F	196	28%	99%	C	296	14%	91%	C	374	7%	86%	VC	433	5%	79%
	0.34	50	20	17	13	12.0	10.0	8.3	6.6	F	192	29%	99%	C	285	15%	92%	C	360	8%	88%	VC	422	5%	80%
	0.37	60	22	18	15	14.0	11.0	9.1	7.3	F	184	32%	99%	M	266	17%	93%	C	337	9%	89%	C	403	6%	83%
	0.38	65	23	19	15	14.0	11.0	9.5	7.6	F	181	33%	99%	M	258	18%	93%	C	327	10%	90%	C	395	6%	84%
	0.40	70	24	20	16	15.0	12.0	9.8	7.9	F	179	34%	99%	M	251	18%	93%	C	319	10%	91%	C	387	7%	84%
0.42	80	25	21	17	16	13.0	11.0	8.4	F	174	35%	99%	M	239	20%	94%	C	304	11%	92%	C	374	7%	86%	
80-04 Nozzles	Flow	Boom	Sprayer Speed (on 20" spacing) @							ER80-04		#40270-04		SR80-04		#40288-04		MR80-04		#40290-04		DR80-04		#40280-04	
	us gpm	psi	8GPA	10GPA	12.5	15GPA	20GPA	25GPA	30GPA	Class	VMD	<141	<600	Class	VMD	<141	<600	Class	VMD	<141	<600	Class	VMD	<141	<600
	0.28	20	11	8	6.7	5.6	4.2	3.4	2.8	M	251	16%	99%												
	0.32	25	13	9	7.5	6.3	4.7	3.8	3.1	M	239	19%	99%	C	369	5%	85%								
	0.35	30	14	10	8	6.9	5.1	4.1	3.4	M	230	21%	99%	C	349	7%	87%	VC	420	5%	80%	XC	543	2%	62%
	0.37	35	15	11	9	7.4	5.6	4.4	3.7	M	222	22%	99%	C	331	9%	88%	VC	401	6%	82%	XC	523	3%	65%
	0.40	40	16	12	10	7.9	5.9	4.8	4.0	M	216	24%	99%	C	316	10%	89%	C	385	7%	84%	XC	507	3%	68%
	0.42	45	17	13	10	8	6.3	5.0	4.2	F	211	25%	99%	C	303	11%	90%	C	372	8%	85%	XC	493	3%	70%
	0.45	50	18	13	11	9	6.6	5.3	4.4	F	206	26%	99%	C	291	12%	91%	C	360	9%	86%	XC	480	4%	72%
	0.49	60	19	15	12	10	7.3	5.8	4.8	F	198	28%	99%	M	270	14%	92%	C	341	10%	88%	XC	460	4%	75%
0.51	65	20	15	12	10	8	6.1	5.0	F	195	29%	99%	M	261	14%	92%	C	333	11%	88%	VC	451	5%	76%	
0.53	70	21	16	13	10	8	6.3	5.2	F	192	29%	99%	M	252	15%	92%	C	326	11%	89%	VC	443	5%	77%	
0.57	80	22	17	13	11	8	6.7	5.6	F	186	31%	99%	M	237	16%	93%	C	313	12%	90%	C	429	5%	79%	
80-05 Nozzles	Flow	Boom	Sprayer Speed (on 20" spacing) @							ER80-05		#40270-05		SR80-05		#40288-05		MR80-05		#40290-05		DR80-05		#40280-05	
	us gpm	psi	10GPA	12.5	15GPA	18GPA	20GPA	25GPA	30GPA	Class	VMD	<141	<600	Class	VMD	<141	<600	Class	VMD	<141	<600	Class	VMD	<141	<600
	0.35	20	11	8	7	5.8	5.3	4.2	3.5	C	296	11%	95%												
	0.40	25	12	9	8	6.5	5.9	4.7	3.9	C	280	14%	95%	VC	411	5%	81%								
	0.43	30	13	10	9	7	6.4	5.1	4.3	M	267	16%	95%	C	387	7%	83%	XC	504	3%	68%	XC	574	2%	56%
	0.47	35	14	11	9	8	6.9	5.6	4.6	M	257	18%	95%	C	367	9%	84%	XC	483	4%	71%	XC	555	2%	59%
	0.50	40	15	12	10	8	7.4	5.9	5.0	M	248	20%	95%	C	349	10%	86%	VC	466	4%	73%	XC	538	2%	62%
	0.53	45	16	13	11	9	8	6.3	5.3	M	241	21%	95%	C	334	11%	87%	VC	451	5%	75%	XC	524	3%	65%
	0.56	50	17	13	11	9	8	6.6	5.5	M	235	22%	95%	C	320	12%	87%	VC	438	5%	77%	XC	512	3%	67%
	0.61	60	18	15	12	10	9	7	6.1	M	224	25%	95%	C	296	14%	89%	VC	417	6%	79%	XC	492	3%	70%
0.64	65	19	15	13	11	10	8	6.3	M	220	26%	95%	C	286	14%	89%	C	408	6%	81%	XC	483	4%	71%	
0.66	70	20	16	13	11	10	8	6.5	F	215	26%	95%	C	276	15%	90%	C	400	6%	81%	VC	475	4%	72%	
0.71	80	21	17	14	12	11	8	7	F	208	28%	95%	M	258	16%	91%	C	385	7%	83%	VC	461	4%	74%	
80-06 Nozzles	Flow	Boom	Sprayer Speed (on 20" spacing) @							ER80-06		#40270-06		SR80-06		#40288-06		MR80-06		#40290-06		DR80-06		#40280-06	
	us gpm	psi	10GPA	12.5	15GPA	18GPA	20GPA	25GPA	30GPA	Class	VMD	<141	<600	Class	VMD	<141	<600	Class	VMD	<141	<600	Class	VMD	<141	<600
	0.42	20	13	10	8	7	6.3	4.2	3.6	C	322	12%	92%												
	0.47	25	14	11	9	8	7.0	4.7	4.0	C	308	15%	91%	VC	440	4%	78%								
	0.52	30	15	12	10	9	8	5.1	4.4	C	296	17%	91%	VC	420	5%	81%	XC	526	2%	64%	XC	596	1%	51%
	0.56	35	17	13	11	9	8	5.6	4.8	C	287	18%	91%	VC	403	6%	83%	XC	508	3%	67%	XC	579	2%	54%
	0.60	40	18	14	12	10	9	6	5.1	C	279	20%	91%	C	390	7%	84%	XC	492	3%	70%	XC	564	2%	57%
	0.64	45	19	15	13	11	10	6	5.4	C	273	21%	91%	C	378	7%	85%	XC	479	4%	72%	XC	551	2%	59%
	0.67	50	20	16	13	11	10	7	6	M	267	22%	90%	C	368	8%	86%	VC	468	4%	73%	XC	540	2%	61%
	0.73	60	22	17	15	12	11	7	6	M	257	24%	90%	C	351	9%	88%	VC	448	5%	76%	XC	521	3%	64%
0.76	65	23	18	15	13	11	8	7	M	253	25%	90%	C	344	9%	89%	VC	440	5%	77%	XC	513	3%	65%	
0.79	70	24	19	16	13	12	8	7	M	249	26%	90%	C	337	10%	89%	VC	433	5%	78%	XC	505	3%	66%	
0.85	80	25	20	17	14	13	8	7	M	242	27%	90%	C	326	10%	90%	C	419	6%	80%	XC	492	3%	68%	
80-08 Nozzles	Flow	Boom	Sprayer Speed (on 20" spacing) @							ER80-08		#40270-08		SR80-08		#40288-08		MR80-08		#40290-08		DR80-08		#40280-08	
	us gpm	psi	15GPA	18GPA	20GPA	25GPA	30GPA	35GPA	40GPA	Class	VMD	<141	<600	Class	VMD	<141	<600	Class	VMD	<141	<600	Class	VMD	<141	<600
	0.57	20	11	9	8	7	6	4.8	4.2	VC	367	12%	86%												
	0.63	25	13	10	9	8	6	5	4.7	C	338	15%	89%	UC	516	7%	54%								
	0.69	30	14	11	10	8	7	6	5	C	317	17%	90%	UC	490	8%	59%								
	0.75	35	15	12	11	9	7	6	6	M	300	19%	92%	XC	468	8%	63%	UC	518	7%	67%	UC	600	4%	55%
	0.80	40	16	13	12	10	8	7	6	M	286	21%	93%	XC	449	9%	66%	UC	500	8%	69%	UC	585	4%	58%
	0.85	45	17	14	13	10	8	7	6	M	274	22%	93%	XC	432	10%	69%	UC	484	9%	71%	UC	571	4%	60%
	0.89	50	18	15	13	11	9	8	7	M	264	23%	94%	XC	417	10%	71%	XC	470	9%	73%	UC	559	5%	62%
	0.98	60	19	16	15	12	10	8	7	F	247	26%	95%	XC	390	11%	74%	XC	448	10%	76%	UC	539	5%	65%
1.02	65	20	17	15	12	10	9	8	F	240	27%	95%	VC	379	12%	75%	XC	438	11%	77%	UC	531	5%	66%	
1.06	70	21	17	16	13	10	9	8	F	233	28%	95%	VC	368	12%	76%	XC	430	11%	78%	UC	523	6%	67%	
1.13	80	22	19																						

COMBO-JET 80° Spray Tips - Standard Sprayer Systems

	Flow us gpm	Boom psi	Sprayer Speed (on 20" spacing) @								ER80-125		#40270-125		SR80-125		#40288-125		MR80-125		#40290-125		DR80-125		#40280-125		
			20GPA	25GPA	30GPA	35GPA	40GPA	45GPA	50GPA	55GPA	Class	VMD	<141	<600	Class	VMD	<141	<600	Class	VMD	<141	<600	Class	VMD	<141	<600	Class
80-125 Nozzles	0.99	25	15	12	10	8	7	7	6	XC	433	10%	79%	UC	531	6%	51%	UC	585	5%	56%	UC	624	4%	50%		
	1.08	30	16	13	11	9	8	7	6	XC	413	11%	81%	UC	509	7%	55%	UC	569	6%	58%	UC	609	4%	52%		
	1.17	35	17	14	12	10	9	8	7	VC	397	12%	82%	UC	490	8%	58%	UC	556	6%	60%	UC	595	5%	54%		
	1.25	40	19	15	12	11	9	8	7	VC	383	13%	83%	XC	474	8%	61%	UC	545	7%	62%	UC	584	5%	56%		
	1.33	45	20	16	13	11	10	9	8	C	372	14%	84%	XC	460	9%	63%	UC	535	7%	63%	UC	574	5%	57%		
	1.40	50	21	17	14	12	10	9	8	C	362	14%	85%	XC	447	9%	65%	UC	519	8%	66%	UC	557	6%	59%		
	1.53	60	23	18	15	13	11	10	9	C	345	15%	87%	XC	425	10%	68%	UC	511	8%	67%	UC	549	6%	60%		
	1.59	65	24	19	16	14	12	11	10	C	338	16%	87%	XC	407	11%	70%	XC	505	8%	67%	UC	543	6%	61%		
	1.65	70	25	20	16	14	12	11	10	C	331	16%	88%	XC	391	11%	72%	XC	493	9%	69%	UC	531	6%	63%		
	1.77	80	26	21	18	15	13	12	11	M	320	17%	88%	VC	391	11%	72%	XC	493	9%	69%	UC	531	6%	63%		
80-15 Nozzles	1.19	25	14	12	10	9	8	7	6	XC	434	9%	78%	UC	576	5%	43%	UC	513	7%	66%	UC	637	3%	48%		
	1.30	30	15	13	11	10	9	8	7	XC	412	10%	79%	UC	554	6%	47%	UC	495	8%	69%	UC	620	3%	51%		
	1.40	35	17	14	12	10	9	8	8	XC	394	11%	80%	UC	535	6%	51%	UC	480	8%	70%	UC	605	3%	53%		
	1.50	40	18	15	13	11	10	9	8	VC	379	12%	81%	UC	519	6%	53%	UC	467	9%	72%	UC	592	4%	55%		
	1.59	45	19	16	14	12	11	10	9	C	366	13%	82%	UC	505	7%	56%	XC	456	9%	73%	UC	581	4%	57%		
	1.68	50	20	17	14	12	11	10	9	C	355	14%	82%	UC	492	7%	58%	XC	438	10%	75%	UC	562	4%	59%		
	1.84	60	22	18	16	14	12	11	10	C	337	15%	83%	XC	471	7%	61%	XC	430	11%	76%	UC	554	4%	61%		
	1.91	65	23	19	16	14	13	11	10	M	329	16%	84%	XC	461	7%	62%	XC	422	11%	77%	UC	547	4%	62%		
	1.98	70	24	20	17	15	13	12	11	M	322	17%	84%	XC	452	8%	63%	XC	410	12%	78%	UC	534	5%	63%		
	2.12	80	25	21	18	16	14	13	11	M	310	18%	85%	XC	436	8%	65%	VC	410	12%	78%	UC	534	5%	63%		
80-20 Nozzles	1.58	25	16	13	12	10	9	9	8	UC	483	8%	71%	UC	574	5%	44%	UC	564	5%	58%	UC	628	3%	50%		
	1.73	30	17	15	13	11	10	9	9	XC	460	9%	73%	UC	551	5%	48%	UC	542	5%	62%	UC	606	3%	54%		
	1.87	35	19	16	14	12	11	10	9	XC	442	10%	75%	UC	532	6%	51%	UC	523	6%	64%	UC	587	4%	56%		
	2.00	40	20	17	15	13	12	11	10	XC	427	11%	76%	UC	515	6%	54%	UC	508	7%	66%	UC	571	4%	59%		
	2.12	45	21	18	16	14	13	11	11	XC	415	11%	78%	UC	500	6%	56%	UC	494	7%	68%	UC	556	4%	61%		
	2.24	50	22	19	17	15	13	12	11	VC	403	12%	79%	UC	487	7%	58%	UC	472	8%	71%	UC	533	5%	64%		
	2.45	60	24	21	18	16	15	13	12	C	385	13%	81%	XC	464	7%	62%	XC	462	8%	72%	UC	523	5%	65%		
	2.55	65	25	22	19	17	15	14	13	C	377	13%	81%	XC	454	7%	63%	XC	453	8%	73%	UC	514	5%	66%		
	2.65	70	26	22	20	17	16	14	13	C	370	14%	82%	XC	444	7%	64%	XC	438	9%	74%	UC	498	5%	68%		
	2.83	80	28	24	21	19	17	15	14	C	357	15%	83%	XC	427	8%	66%	XC	427	8%	74%	UC	498	5%	68%		
80-25 Nozzles	1.98	25	17	15	13	12	11	10	8	UC	485	9%	70%	UC	532	5%	51%	UC	604	4%	55%	UC	657	3%	46%		
	2.17	30	18	16	14	13	12	11	9	XC	462	10%	72%	UC	511	5%	54%	UC	583	4%	58%	UC	635	3%	49%		
	2.34	35	20	17	15	14	13	12	10	XC	443	10%	74%	UC	494	6%	57%	UC	566	4%	60%	UC	617	3%	52%		
	2.50	40	21	19	17	15	14	12	11	XC	427	11%	75%	UC	479	6%	59%	UC	552	5%	62%	UC	601	3%	55%		
	2.65	45	23	20	18	16	14	13	11	VC	414	12%	76%	XC	466	7%	61%	UC	539	5%	63%	UC	587	3%	57%		
	2.80	50	24	21	18	17	15	14	12	VC	402	12%	77%	XC	454	7%	62%	UC	518	5%	66%	UC	563	4%	60%		
	3.06	60	26	23	20	18	17	15	13	C	383	13%	79%	XC	434	7%	65%	UC	508	6%	67%	UC	553	4%	61%		
	3.19	65	27	24	21	19	17	16	14	C	375	14%	79%	XC	425	8%	66%	UC	500	6%	68%	UC	544	4%	62%		
	3.31	70	28	25	22	20	18	16	14	C	367	14%	80%	XC	417	8%	67%	UC	485	6%	69%	UC	528	4%	64%		
	3.54	80	30	26	23	21	19	18	15	C	354	15%	81%	XC	402	8%	68%	UC	480	7%	69%	XC	479	4%	68%		
80-30 Nozzles	2.37	25	18	14	12	10	9	8	7	UC	506	5%	67%	UC	508	5%	54%	UC	591	4%	55%	UC	654	2%	47%		
	2.60	30	19	15	13	11	10	9	8	UC	481	6%	69%	UC	490	5%	57%	UC	572	4%	58%	UC	623	2%	51%		
	2.81	35	21	17	14	12	10	9	8	XC	461	7%	71%	UC	474	6%	59%	UC	556	4%	60%	UC	597	3%	54%		
	3.00	40	22	18	15	13	11	10	9	XC	444	7%	73%	XC	461	6%	61%	UC	542	5%	62%	UC	575	3%	57%		
	3.18	45	24	19	16	14	12	11	10	XC	430	8%	74%	XC	449	6%	62%	UC	530	5%	64%	UC	556	3%	59%		
	3.35	50	25	20	17	14	12	11	10	XC	417	9%	75%	XC	429	6%	65%	UC	510	5%	67%	UC	525	3%	63%		
	3.67	60	27	22	18	16	14	12	11	XC	397	9%	77%	XC	421	7%	66%	UC	493	6%	69%	UC	500	4%	66%		
	3.82	65	28	23	19	16	14	13	11	XC	388	10%	77%	XC	414	7%	67%	UC	480	7%	71%	XC	479	4%	68%		
	3.97	70	29	24	20	17	15	13	12	VC	380	10%	78%	XC	400	7%	69%	UC	466	6%	72%	UC	466	6%	72%		
	4.24	80	32	25	21	18	16	14	13	VC	366	11%	79%	XC	400	7%	69%	UC	466	6%	72%	UC	466	6%	72%		
80-40 Nozzles	3.74	35	22	19	16	14	12	11	9	XC	460	7%	71%	UC	481	5%	58%	UC	541	4%	61%						
	4.00	40	24	20	17	15	13	12	10	XC	444	8%	73%	XC	467	5%	60%	UC	524	5%	63%						
	4.24	45	25	21	18	16	14	13	11	XC	430	9%	74%	XC	455	5%	62%	UC	510	5%	65%						
	4.47	50	27	22	19	17	15	13	11	XC	418	9%	75%	XC	445	6%	63%	UC	498	5%	66%						
	4.90	60	29	24	21	18	16	15	12	XC	398	10%	77%	XC	428	6%	66%	XC	477	5%	68%						
	5.10	65	30	25	22	19	17	15	13	XC	390	10%	77%	XC	420	6%	67%	XC	468	6%	69%						
	5.29	70	31	26	22	20	17	16	13	XC	382	11%	78%	XC	414	6%	67%	XC	460	6%	70%						
	7.07	80	42	35	30	26	23	21	18	VC	369	11%	79%	XC	402	7%	69%	XC	446	6%	72%						
80-50 Nozzles	4.68	35	20	17	15	14	13	12	11	XC	466	7%	70%														
	5.00	40	21	19	17	15	14	12	11	XC	450	7%	72%														
	5.30	45	23	20	18	16	14	13	12	XC	437	8%	73%														
	5.59	50	24	21	18	17	15	14	13	XC	425	8%	74%														
	6.12	60	26	23	20	18	17	15	14	XC	405	9%	76%														
	6.37	65	27	24	21	19	17	16	15	XC	396	9%	76%														
	6.61	70	28	25	22	20	18	16	15	XC	389	9%	77%														
	7.07	80	30	26	23	21	19	18	16	VC	375	10%	78%														
80-60 Nozzles	5.61	35	19	14	12	10	9	8	8	XC	458	8%	69%														
	6.00	40	20	15	13	11	10	9	8	XC	444	8%	70%														
	6.36	45	21	16	14	12	11	10	9	XC	433	9%	71%														
	6.71	50	22	17	14	12	11	10	9	XC	422	9%	72%														
	7.35	60	24	18	16	14																					

COMBO-JET 110° Spray Tips - Standard Sprayer Systems

Comprehensive rate & speed charts for any nozzle spacing/speed/rate is available on Tip Wizard. Try it today!

! Disclaimer: These charts are published for comparative purposes to demonstrate the differences in the series of Combo-Jet® spray tips. Data used to populate this chart is extrapolated from third party testing data from a controlled conditions test with water as the testing solution. Actual spray applications with active chemical ingredients may change the spray dynamics and spray tip performance specifications. Wilger is not liable for any misuse or misrepresentation of this information, leading to (but not limited to) incorrect spray application, crop damage, or any other harm. (Not limited to human, livestock or environmental). Always verify these charts with the most recent charts found on the www.wilger.net, and ALWAYS follow chemical label nozzle requirements.

Nozzles	Flow US gpm	Boom psi	Sprayer Speed (on 20" spacing) @								ER110-15		#40281-15		SR110-15		#40287-15		MR110-15		#40291-15		DR110-15		#40286-15	
			25GPA	30GPA	35GPA	40GPA	45GPA	50GPA	55GPA	60GPA	Class	VMD	Class	VMD	Class	VMD	Class	VMD	Class	VMD	Class	VMD	Class	VMD	Class	VMD
110 -15 Nozzles	1.19	25	14	12	10	9	8	7	6	XC	416	10%	68%													
	1.30	30	15	13	11	10	9	8	7	XC	398	10%	72%	UC	538	5%	51%									
	1.40	35	17	14	12	10	9	8	8	XC	383	11%	74%	UC	515	5%	55%	UC	590	4%	43%	UC	641	4%	43%	
	1.50	40	18	15	13	11	10	9	8	VC	370	12%	76%	UC	496	6%	58%	UC	574	4%	45%	UC	624	4%	46%	
	1.59	45	19	16	14	12	11	10	9	VC	358	12%	77%	XC	478	6%	61%	UC	560	5%	47%	UC	610	4%	48%	
	1.68	50	20	17	14	12	11	10	9	C	348	13%	79%	XC	463	6%	64%	UC	548	5%	49%	UC	597	4%	50%	
	1.84	60	22	18	16	14	12	11	10	C	330	14%	81%	XC	436	7%	67%	UC	527	5%	52%	UC	575	4%	53%	
	1.91	65	23	19	16	14	13	11	10	C	322	14%	82%	XC	424	7%	69%	UC	517	5%	53%	UC	565	4%	54%	
	1.98	70	24	20	17	15	13	12	11	C	315	15%	82%	XC	413	7%	70%	UC	508	5%	54%	UC	556	4%	55%	
	2.12	80	25	21	18	16	14	13	11	C	302	15%	84%	XC	393	8%	72%	UC	493	5%	56%	UC	540	5%	58%	
110 -20 Nozzles	1.58	25	16	13	12	10	9	9	8	XC	473	7%	60%													
	1.73	30	17	15	13	11	10	9	9	XC	453	8%	64%													
	1.87	35	19	16	14	12	11	10	9	XC	437	8%	66%	UC	497	6%	59%	UC	574	5%	45%					
	2.00	40	20	17	15	13	12	11	10	XC	422	9%	68%	XC	479	6%	62%	UC	557	5%	48%					
	2.12	45	21	18	16	14	13	11	11	XC	410	9%	70%	XC	463	7%	65%	UC	542	5%	50%					
	2.24	50	22	19	17	15	13	12	11	XC	399	9%	72%	XC	449	7%	67%	UC	529	6%	52%					
	2.45	60	24	21	18	16	15	13	12	XC	379	10%	74%	XC	424	8%	70%	UC	506	6%	55%					
	2.55	65	25	22	19	17	15	14	13	VC	370	10%	75%	XC	413	8%	72%	UC	496	6%	56%					
	2.65	70	26	22	20	17	16	14	13	VC	362	10%	76%	XC	403	8%	73%	UC	487	6%	57%					
	2.83	80	28	24	21	19	17	15	14	C	348	11%	78%	XC	385	8%	75%	XC	470	7%	59%					
110 -25 Nozzles	1.98	25	17	15	13	12	11	10	8	XC	472	7%	60%													
	2.17	30	18	16	14	13	12	11	9	XC	453	7%	65%													
	2.34	35	20	17	15	14	13	12	10	XC	437	7%	68%	UC	484	6%	59%									
	2.50	40	21	19	17	15	14	12	11	XC	422	7%	71%	XC	468	6%	62%									
	2.65	45	23	20	18	16	14	13	11	XC	410	8%	73%	XC	453	7%	64%									
	2.80	50	24	21	18	17	15	14	12	XC	399	8%	74%	XC	441	7%	66%									
	3.06	60	26	23	20	18	17	15	13	XC	380	8%	77%	XC	419	8%	69%									
	3.19	65	27	24	21	19	17	16	14	VC	371	8%	78%	XC	409	8%	70%									
	3.31	70	28	25	22	20	18	16	14	VC	364	8%	79%	XC	400	8%	71%									
	3.54	80	30	26	23	21	19	18	15	C	350	8%	81%	XC	384	8%	73%									
110 -30 Nozzles	2.37	25	18	14	12	10	9	8	7	UC	484	6%	58%													
	2.60	30	19	15	13	11	10	9	8	XC	466	6%	61%													
	2.81	35	21	17	14	12	10	9	8	XC	451	7%	63%													
	3.00	40	22	18	15	13	11	10	9	XC	437	7%	65%													
	3.18	45	24	19	16	14	12	11	10	XC	425	8%	67%													
	3.35	50	25	20	17	14	12	11	10	XC	415	8%	68%													
	3.67	60	27	22	18	16	14	12	11	XC	396	9%	70%													
	3.82	65	28	23	19	16	14	13	11	XC	388	9%	71%													
	3.97	70	29	24	20	17	15	13	12	XC	381	9%	72%													
	4.24	80	32	25	21	18	16	14	13	VC	367	9%	73%													

LERAP Drift Reduction Star Rating for COMBO-JET 110° Spray Nozzles [For UK applicators]

Local Environmental Risk Assessments for Pesticides (LERAP) certification is completed in the UK to provide applications a means to qualify a local drift reduction assessment based on the nozzles used for an application. Stay tuned for further LERAP nozzle testing for more nozzles.

LERAP RATING	Nozzle	Pressure Range
**** 90% Drift Reduction	DR110-03	1.0 - 1.5 BAR
	DR110-05	1.0 - 1.5 BAR
	DR110-06	1.0 - 3.0 BAR
	MR110-05	1.0 - 1.5 BAR
	MR110-06	1.0 - 1.5 BAR

The 4-star LERAP rating is a new rating that illustrates the highest classification for drift reduction within the standard certification. (List updated January 2021)

LERAP RATING	Nozzle	Pressure Range
*** 75% Drift Reduction	DR110-025	1.0 - 2.5 BAR
	DR110-03	1.6 - 3.0 BAR
	DR110-04	1.0 - 5.0 BAR
	DR110-05	1.6 - 5.0 BAR
	DR110-06	3.1 - 5.0 BAR
	MR110-04	1.0 - 2.5 BAR
	MR110-05	1.6 - 5.0 BAR
	MR110-06	1.6 - 5.0 BAR
	SR110-05	1.0 - 1.5 BAR

LERAP RATING	Nozzle	Pressure Range
** 50% Drift Reduction	DR110-025	2.6 - 3.5 BAR
	DR110-03	3.1 - 5.0 BAR
	MR110-04	2.6 - 3.5 BAR
	SR110-05	1.6 - 3.0 BAR

For the updated list on COMBO-JET nozzles, visit www.wilger.net/LERAP

More information on LERAP certification, process, and the most up to date listing of approved nozzles and their ratings, is available from the Health and Safety Executive (HSE), also available online @ <https://secure.pesticides.gov.uk/SprayEquipment>

COMBO-JET 80° Spray Tips - PWM Spray Systems

Comprehensive rate & speed charts for any nozzle spacing/speed/rate is available on Tip Wizard. Try it today!

Disclaimer: These charts are published for comparative purposes to demonstrate the differences in the series of Combo-Jet® spray tips. Data used to populate this chart is extrapolated from third party testing data from a controlled conditions test with water as the testing solution. Actual spray applications with active chemical ingredients may change the spray dynamics and spray tip performance specifications. Wilger is not liable for any misuse or misrepresentation of this information, leading to (but not limited to) incorrect spray application, crop damage, or any other harm. (Not limited to human, livestock or environmental). Always verify these charts with the most recent charts found on the www.wilger.net, and ALWAYS follow chemical label nozzle requirements.

ASABE Spray Classification (ASABE S572.1 Standard)

Spray quality is categorized based on Dv0.1 and VMD droplet sizes. Objective testing data (by 3rd party), from spray spectrum recording equipment (without wind tunnel use), has been used to classify spray quality for this chart. Extra data (e.g. VMD, etc.) can vary between testing equipment and method, and is provided as an educational resource only. Tips sized up to 110-06 verified on Phase Doppler Particle Analyzer (PDPA); tips sized over 110-06 verified on Malvern.

- Fine (F)
- Medium (M)
- Coarse (C)
- Very Coarse (VC)
- Extremely Coarse (XC)
- Ultra Coarse (UC)

VMD (Volume Median Diameter)
The median droplet (in μ) for a sprayed volume. Half of the volume is made of droplets smaller, with half made up of droplets larger.

% <141 μ (% Driftable Fines)
Percentage of volume which is likely to drift. As wind & boom height increase, observed spray drift will increase substantially.

% <600 μ (% of Small Droplets)
% of volume which is made up of 'small' droplets, useful for coverage. As % of useful droplets lowers, overall coverage is reduced.

Duty Cycle (Effective 'on time' of solenoid)

The duty cycle is the effective 'on time' of a PWM solenoid. Generally speed ranges are based on a 25% - 100% duty cycle. When selecting a nozzle, often a duty cycle of 60-80% is recommended at typical speeds, providing flexibility for upper speed & turning situations, as well as slower spraying speeds. It is not advised to spray below 40% duty cycle.

Calculating Duty Cycle on Printed Charts (Useful for nozzle sizing & selection)

On Wilger printed charts, typically a SPEED RANGE is provided, but the duty cycle % is a dynamic factor based on the sprayers travel speed. To calculate a duty cycle at a given travel speed, divide CURRENT sprayer speed into max nozzle speed. (e.g. 15mph / 20mph max = 75% duty cycle)

PWM SPRAY CHARTS

Nozzle Size & Angle	Flow Rate USGPM	Boom PSI	Tip psi	Application Rate in US Gallons / Acre on 20" Nozzle Spacing					Spray Classification; VMD (Droplet Size in μ); % <141 μ (Drift %); % <600 μ (Small Droplets)																				
				@ Sprayer Speed in Miles / Hour					ER80° Series				SR80° Series				MR80° Series				DR80° Series								
				Sprayer Speed (on 20" spacing) @					Class	VMD	<141	<600	Class	VMD	<141	<600	Class	VMD	<141	<600	Class	VMD	<141	<600					
				2GPA	3GPA	4GPA	5GPA																						
80-005 Nozzles	0.035	20	20	1.3-5.3					F	167	33%	100%																	
	0.071	80	80	2.8-11					F	111	78%	100%																	
	80-0067 Nozzles	0.047	20	20	1.8-7					F	199	21%	100%																
		0.095	70	70	3.3-13					F	118	63%	100%																
		80-01 Nozzles	0.07	20	20	2.5-10					F	176	28%	100%	C	293	8%	97%											
			0.14	45	45	4-16					F	139	53%	100%	F	187	33%	97%	F	182	33%	97%	M	261	15%	97%			
			80-015 Nozzles	0.11	20	20	2.5-10					F	200	21%	100%														
				0.21	80	79	5.3-21					F	140	48%	100%	F	168	35%	98%	F	201	23%	99%	C	303	10%	95%		
				80-02 Nozzles	0.14	20	20	3.5-14					F	185	28%	100%	C	275	12%	94%									
					0.28	80	79	7-28					F	142	49%	100%	F	186	32%	98%	M	240	19%	95%	C	347	7%	90%	

NOTE: 'SR, MR, DR, UR spray tips include pre-orifice(s). Pre-orifices are not interchangeable between different spray tips of different series. *Shown application information is based on water @ 80°F in a controlled environment and should not be considered actual. Information is provided for comparison to other Combo-Jet® spray tips, for educational purposes only. Repeat testing results can vary.

COMBO-JET 80° Spray Tips - PWM Spray Systems

ASABE Spray Classification (ASABE S572.1 Standard)

Spray quality is categorized based on Dv0.1 and VMD droplet sizes. Objective testing data (by 3rd party), from spray spectrum recording equipment (without wind tunnel use), has been used to classify spray quality for this chart. Extra data (e.g. VMD, etc.) can vary between testing equipment and method, and is provided as an educational resource only. Tips sized up to 110-06 verified on Phase Doppler Particle Analyzer (PDPA); tips sized over 110-06 verified on Malvern.

- Fine (F)
- Medium (M)
- Coarse (C)
- Very Coarse (VC)
- Extremely Coarse (XC)
- Ultra Coarse (UC)

VMD (Volume Median Diameter)

The median droplet (in μ) for a sprayed volume. Half of the volume is made of droplets smaller, with half made up of droplets larger.

% <141 μ (% Driftable Fines)

Percentage of volume which is likely to drift. As wind & boom height increase, observed spray drift will increase substantially.

% <600 μ (% of Small Droplets)

% of volume which is made up of 'small' droplets, useful for coverage. As % of useful droplets lowers, overall coverage is reduced.

Duty Cycle (Effective 'on time' of solenoid)

The duty cycle is the effective 'on time' of a PWM solenoid. Generally speed ranges are based on a 25% - 100% duty cycle. When selecting a nozzle, often a duty cycle of 60-80% is recommended at typical speeds, providing flexibility for upper speed & turning situations, as well as slower spraying speeds. It is not advised to spray below 40% duty cycle.

Calculating Duty Cycle on Printed Charts (Useful for nozzle sizing & selection)

On Wilger printed charts, typically a SPEED RANGE is provided, but the duty cycle % is a dynamic factor based on the sprayers travel speed. To calculate a duty cycle at a given travel speed, divide CURRENT sprayer speed into max nozzle speed. (e.g. 15mph / 20mph max = 75% duty cycle)

Nozzles	Flow us gpm	Boom psi	Tip psi	Sprayer Speed (on 20" spacing) @				ER80-025 Class	VMD	#40270-025		SR80-025 Class	VMD	#40288-025		MR80-025 Class	VMD	#40290-025		DR80-025 Class	VMD	#40280-025	
				3GPA	4GPA	5GPA	6GPA			<141	<600			<141	<600			<141	<600			<141	<600
				19	24	29	34			39	44			17%	100%			9%	91%			4%	80%
80-025	0.17	20	19	4.3-17	3.3-13	2.5-10	2.2-8.6	M	234	17%	100%												
	0.20	25	24	4.8-19	3.5-14	3-12	2.4-9.7	M	220	20%	100%	C	318	9%	91%								
	0.21	30	29	5.3-21	4-16	3.3-13	2.8-11	F	210	23%	100%	C	299	11%	92%	VC	429	4%	80%	XC	463	3%	77%
	0.23	35	34	5.8-23	4.3-17	3.5-14	2.8-11	F	202	25%	100%	C	283	13%	93%	VC	405	5%	83%	VC	446	4%	79%
	0.25	40	39	6-24	4.5-18	3.8-15	3-12	F	195	28%	100%	M	270	15%	94%	C	386	6%	84%	VC	432	4%	80%
	0.26	45	44	6.5-26	4.8-19	4-16	3.3-13	F	189	29%	100%	M	260	16%	95%	C	370	7%	86%	VC	420	5%	82%
	0.28	50	49	6.8-27	5-20	4-16	3.5-14	F	184	31%	100%	M	250	18%	95%	C	356	8%	87%	VC	410	5%	83%
	0.30	60	58	7.5-30	5.5-22	4.5-18	3.8-15	F	175	34%	100%	M	235	20%	96%	C	333	9%	88%	C	393	6%	84%
	0.31	65	63	7.8-31	5.8-23	4.8-19	4-16	F	171	35%	100%	M	228	21%	96%	C	324	9%	89%	C	386	6%	85%
	0.33	70	68	8-32	6-24	4.8-19	4-16	F	168	36%	100%	M	223	22%	97%	C	315	10%	90%	C	379	7%	86%
0.35	80	78	8.8-35	6.5-26	5.3-21	4.3-17	F	162	38%	99%	F	213	24%	97%	C	300	11%	91%	C	367	7%	87%	
80-03	0.21	20	19	3.8-15	3-12	2.5-10	1.9-7.7	M	235	17%	99%												
	0.23	25	24	4.3-17	3.5-14	3-12	2.2-8.6	M	224	20%	99%	C	373	7%	88%								
	0.26	30	29	4.8-19	3.8-15	3.3-13	2.4-9.5	F	215	22%	99%	C	349	9%	89%	VC	437	4%	80%	XC	485	3%	71%
	0.28	35	34	5-20	4-16	3.5-14	2.5-10	F	208	24%	99%	C	330	11%	90%	VC	414	5%	83%	XC	466	3%	74%
	0.29	40	39	5.5-22	4.3-17	3.8-15	2.8-11	F	203	26%	99%	C	314	12%	91%	VC	395	6%	85%	VC	451	4%	76%
	0.31	45	43	5.8-23	4.8-19	3.8-15	3-12	F	198	27%	99%	C	300	13%	91%	C	378	7%	86%	VC	437	5%	78%
	0.33	50	48	6-24	5-20	4-16	3-12	F	193	29%	99%	C	289	14%	92%	C	364	8%	87%	VC	426	5%	80%
	0.36	60	58	6.8-27	5.3-21	4.5-18	3.3-13	F	186	31%	99%	M	270	16%	93%	C	341	9%	89%	VC	406	6%	82%
	0.38	65	63	7-28	5.5-22	4.8-19	3.5-14	F	183	32%	99%	M	262	17%	93%	C	332	10%	90%	C	398	6%	83%
	0.39	70	68	7.3-29	5.8-23	4.8-19	3.5-14	F	180	33%	99%	M	255	18%	93%	C	323	10%	90%	C	391	7%	84%
0.42	80	77	7.8-31	6.3-25	5.3-21	3.8-15	F	175	35%	99%	M	242	19%	94%	C	308	11%	91%	C	378	7%	85%	
80-04	0.27	20	19	5-20	4-16	2.8-11	2-8.1	M	254	16%	99%												
	0.31	25	23	5.8-23	4.5-18	3-12	2.3-9.1	M	242	18%	99%	C	377	5%	85%								
	0.34	30	28	6.3-25	5-20	3.3-13	2.5-10	M	233	20%	99%	C	356	6%	86%	VC	428	5%	79%	XC	551	2%	60%
	0.36	35	33	6.8-27	5.5-22	3.5-14	2.8-11	M	226	22%	99%	C	339	8%	88%	VC	409	6%	81%	XC	531	2%	64%
	0.39	40	37	7.3-29	5.8-23	3.8-15	3-12	M	219	23%	99%	C	323	9%	89%	C	393	7%	83%	XC	515	3%	67%
	0.41	45	42	7.5-30	6-24	4-16	3-12	F	214	24%	99%	C	310	10%	90%	C	379	8%	84%	XC	500	3%	69%
	0.43	50	47	8-32	6.5-26	4.3-17	3.3-13	F	209	25%	99%	C	298	11%	90%	C	367	8%	86%	XC	488	3%	71%
	0.47	60	56	8.8-35	7-28	4.8-19	3.5-14	F	201	27%	99%	C	277	13%	91%	C	348	10%	87%	XC	467	4%	74%
	0.49	65	61	9.3-37	7.3-29	5-20	3.8-15	F	198	28%	99%	M	268	14%	92%	C	340	10%	88%	XC	458	4%	75%
	0.51	70	66	9.5-38	7.5-30	5-20	3.8-15	F	195	29%	99%	M	260	14%	92%	C	332	11%	89%	VC	450	5%	76%
0.55	80	75	10-41	8.3-33	5.5-22	4-16	F	189	30%	99%	M	245	16%	93%	C	319	12%	90%	VC	436	5%	78%	
80-05	0.34	20	18	4.3-17	3-12	2.5-10	2.1-8.3	C	303	10%	95%												
	0.38	25	23	4.8-19	3.5-14	2.8-11	2.3-9.3	C	287	13%	95%	VC	424	4%	80%								
	0.41	30	27	5-20	3.8-15	3-12	2.5-10	C	274	15%	95%	VC	400	6%	82%	XC	517	3%	65%	XC	587	1%	53%
	0.45	35	32	5.5-22	4.3-17	3.3-13	2.8-11	M	263	17%	95%	C	380	8%	83%	XC	496	3%	69%	XC	567	2%	57%
	0.48	40	36	6-24	4.5-18	3.5-14	3-12	M	255	19%	95%	C	362	9%	85%	XC	478	4%	71%	XC	551	2%	60%
	0.50	45	41	6.3-25	4.8-19	3.8-15	3-12	M	247	20%	95%	C	347	10%	86%	VC	463	4%	74%	XC	536	2%	63%
	0.53	50	45	6.5-26	5-20	4-16	3.3-13	M	241	21%	95%	C	333	11%	87%	VC	450	5%	75%	XC	524	3%	65%
	0.58	60	54	7.3-29	5.5-22	4.3-17	3.5-14	M	230	23%	95%	C	309	13%	88%	VC	428	5%	78%	XC	503	3%	68%
	0.61	65	59	7.5-30	5.8-23	4.5-18	3.8-15	M	225	24%	95%	C	299	13%	89%	VC	419	6%	79%	XC	494	3%	69%
	0.63	70	63	7.8-31	5.8-23	4.8-19	4-16	M	221	25%	95%	C	289	14%	89%	C	410	6%	80%	XC	486	4%	71%
0.67	80	72	8.3-33	6.3-25	5-20	4.3-17	F	214	27%	95%	C	271	15%	90%	C	396	7%	82%	VC	471	4%	73%	
80-06	0.40	20	17	4-16	3-12	2.5-9.8	2-7.8	C	331	11%	92%												
	0.44	25	22	4.5-18	3.3-13	2.8-11	2.2-8.8	C	316	13%	92%	XC	456	3%	76%								
	0.48	30	26	4.8-19	3.5-14	3-12	2.4-9.6	C	305	15%	91%	VC	435	4%	79%	XC	544	2%	61%	XC	613	1%	48%
	0.52	35	30	5.3-21	4-16	3.3-13	2.5-10	C	295	17%	91%	VC	418	5%	81%	XC	524	3%	64%	XC	595	1%	52%
	0.56	40	35	5.5-22	4.3-17	3.5-14	2.8-11	C	287	18%	91%	VC	404	6%	82%	XC	509	3%	67%	XC	579	2%	54%
	0.59	45	39	6-24	4.5-18	3.8-15	3-12	C	281	19%	91%	C	392	7%	84%	XC	495	3%	69%	XC	566	2%	56%
	0.63	50	43	6.3-25	4.8-19	3.8-15	3-12	C	275	21%	91%	C	382	7%	85%	XC	483	4%	71%	XC	555	2%	58%
	0.69	60	52	6.8-27	5-20	4.3-17	3.5-14	M	265	23%	90%	C	364	8%	87%	VC	463	4%	74%	XC	535	3%	61%
	0.71	65	57	7-28	5.3-21	4.5-18	3.5-14	M	260	23%	90%	C	357	9%	87%	VC	4						

COMBO-JET 80° Spray Tips - PWM Spray Systems

Comprehensive rate & speed charts for any nozzle spacing/speed/rate is available on Tip Wizard. Try it today!

⚠ Disclaimer: These charts are published for comparative purposes to demonstrate the differences in the series of Combo-Jet® spray tips. Data used to populate this chart is extrapolated from third party testing data from a controlled conditions test with water as the testing solution. Actual spray applications with active chemical ingredients may change the spray dynamics and spray tip performance specifications. Wilger is not liable for any misuse or misrepresentation of this information, leading to (but not limited to) incorrect spray application, crop damage, or any other harm. (Not limited to human, livestock or environmental). Always verify these charts with the most recent charts found on the www.wilger.net, and ALWAYS follow chemical label nozzle requirements.

ASABE Spray Classification (ASABE S572.1 Standard)

Spray quality is categorized based on D_{v0.1} and VMD droplet sizes. Objective testing data (by 3rd party), from spray spectrum recording equipment (without wind tunnel use), has been used to classify spray quality for this chart. Extra data (e.g. VMD, etc.) can vary between testing equipment and method, and is provided as an educational resource only. Tips sized up to 110-06 verified on Phase Doppler Particle Analyzer (PDPA); tips sized over 110-06 verified on Malvern.

- Fine (F)
- Medium (M)
- Coarse (C)
- Very Coarse (VC)
- Extremely Coarse (XC)
- Ultra Coarse (UC)

VMD (Volume Median Diameter)

The median droplet (in μ) for a sprayed volume. Half of the volume is made of droplets smaller, with half made up of droplets larger.

% <141μ (% Driftable Fines)

Percentage of volume which is likely to drift. As wind & boom height increase, observed spray drift will increase substantially.

% <600μ (% of Small Droplets)

% of volume which is made up of "small" droplets, useful for coverage. As % of useful droplets lowers, overall coverage is reduced.

Nozzles	Flow us.gpm	Boom psi	Tip psi	Sprayer Speed (on 20" spacing) @				ER80-10	#40270-10		SR80-10	#40288-10		MR80-10	#40290-10		DR80-10	#40280-10					
				15GPA	18GPA	20GPA	25GPA		Class	VMD		<141	<600		Class	VMD		<141	<600	Class	VMD	<141	<600
				Class	VMD	<141	<600		Class	VMD		<141	<600		Class	VMD		<141	<600	Class	VMD	<141	<600
80-10	0.73	30	21	3.5-14	3-12	2.8-11	2.2-8.6	XC	450	9%	78%												
	0.79	35	25	4-16	3.3-13	3-12	2.3-9.3	XC	429	10%	80%												
	0.84	40	28	4.3-17	3.5-14	3-12	2.5-10	XC	412	11%	81%												
	0.89	45	32	4.5-18	3.8-15	3.3-13	2.8-11	VC	398	12%	82%												
	0.94	50	35	4.8-19	4-16	3.5-14	2.8-11	VC	385	13%	83%												
	1.03	60	42	5-20	4.3-17	3.8-15	3-12	C	364	15%	85%												
	1.07	65	46	5.3-21	4.5-18	4-16	3.3-13	C	356	15%	85%												
	1.11	70	49	5.5-22	4.5-18	4.3-17	3.3-13	C	348	16%	86%												
	1.19	80	56	6-24	5-20	4.5-18	3.5-14	M	334	17%	87%												
80-125	0.91	35	21	4.5-18	3.8-15	3.5-14	2.8-11	XC	451	9%	77%												
	0.97	40	24	4.8-19	4-16	3.5-14	3-12	XC	436	10%	78%												
	1.03	45	27	5-20	4.3-17	3.8-15	3-12	XC	423	11%	80%												
	1.09	50	30	5.5-22	4.5-18	4-16	3.3-13	XC	412	11%	81%												
	1.19	60	36	6-24	5-20	4.5-18	3.5-14	VC	393	12%	83%												
	1.24	65	39	6.3-25	5-20	4.5-18	3.8-15	VC	385	13%	83%												
	1.29	70	42	6.3-25	5.3-21	4.8-19	3.8-15	C	377	13%	84%												
	1.38	80	48	6.8-27	5.8-23	5-20	4-16	C	364	14%	85%												
	80-15	1.08	40	21	4.5-18	4-16	3.3-13	2.8-11	XC	459	7%	76%											
1.14		45	23	4.8-19	4.3-17	3.5-14	2.8-11	XC	444	8%	77%												
1.20		50	26	5-20	4.5-18	3.5-14	3-12	XC	430	9%	78%												
1.32		60	31	5.5-22	5-20	4-16	3.3-13	XC	408	10%	79%												
1.37		65	34	5.8-23	5-20	4-16	3.5-14	XC	399	11%	80%												
1.43		70	36	6-24	5.3-21	4.3-17	3.5-14	XC	390	12%	80%												
1.52		80	41	6.3-25	5.8-23	4.5-18	3.8-15	VC	375	13%	81%												
80-20		1.37	50	19	6.8-27	5-20	3.5-14	2.5-10	UC	520	6%	66%											
		1.50	60	23	7.5-30	5.5-22	3.8-15	2.8-11	UC	496	7%	69%											
	1.56	65	24	7.8-31	5.8-23	3.8-15	3-12	UC	486	8%	70%												
	1.62	70	26	8-32	6-24	4-16	3-12	UC	477	8%	71%												
	1.73	80	30	8.5-34	6.5-26	4.3-17	3.3-13	XC	460	9%	73%												

NOTE: 'SR, MR, DR, UR spray tips include pre-orifice(s). Pre-orifices are not interchangeable between different spray tips of different series. *Shown application information is based on water @ 80°F in a controlled environment and should not be considered actual. Information is provided for comparison to other Combo-Jet® spray tips, for educational purposes only. Repeat testing results can vary.

COMBO-JET 110° Spray Tips - PWM Spray Systems

Comprehensive rate & speed charts for any nozzle spacing/speed/rate is available on Tip Wizard. Try it today!

⚠ Disclaimer: These charts are published for comparative purposes to demonstrate the differences in the series of Combo-Jet® spray tips. Data used to populate this chart is extrapolated from third party testing data from a controlled conditions test with water as the testing solution. Actual spray applications with active chemical ingredients may change the spray dynamics and spray tip performance specifications. Wilger is not liable for any misuse or misrepresentation of this information, leading to (but not limited to) incorrect spray application, crop damage, or any other harm. (Not limited to human, livestock or environmental). Always verify these charts with the most recent charts found on the www.wilger.net, and ALWAYS follow chemical label nozzle requirements.

ASABE Spray Classification (ASABE S572.1 Standard) Spray quality is categorized based on Dv0.1 and VMD droplet sizes. Objective testing data (by 3rd party), from spray spectrum recording equipment (without wind tunnel use), has been used to classify spray quality for this chart. Extra data (e.g. VMD, etc.) can vary between testing equipment and method, and is provided as an educational resource only. Tips sized up to 110-06 verified on Phase Doppler Particle Analyzer (PDPA); tips sized over 110-06 verified on Malvern.	Fine (F) Medium (M) Coarse (C) Very Coarse (VC) Extremely Coarse (XC) Ultra Coarse (UC)	VMD (Volume Median Diameter) The median droplet (in µ) for a sprayed volume. Half of the volume is made of droplets smaller, with half made up of droplets larger.	% <141µ (% Driftable Fines) Percentage of volume which is likely to drift. As wind & boom height increase, observed spray drift will increase substantially.	% <600µ (% of Small Droplets) % of volume which is made up of 'small' droplets, useful for coverage. As % of useful droplets lowers, overall coverage is reduced.
---	--	--	---	--

Nozzle Size & Angle	Flow Rate USGPM	Boom PSI	Tip psi	Application Rate in US Gallons / Acre on 20" Nozzle Spacing					Spray Classification: VMD (Droplet Size in µ); %<141µ (Drift %); %<600µ (Small Droplets)														
				@ Sprayer Speed in Miles / Hour					ER110° Series		SR110° Series		MR110° Series		DR110° Series		UR Series						
				2GPA	3GPA	4GPA	5GPA	6GPA	Class	VMD	Class	VMD	Class	VMD	Class	VMD	Class	VMD	Class	VMD			
110-01 Nozzles	Flow us gpm	Boom psi	Tip psi	Sprayer Speed (on 20" spacing) @					ER110-01	#40281-01													
	0.07	20	20	2.5-10	1.8-7	1.3-5.2	1.1-4.2	F	149	45%	100%												
	0.08	25	25	3-12	2-7.8	1.5-5.9	1.2-4.7	F	144	48%	100%												
	0.09	30	30	3.3-13	2.2-8.6	1.6-6.4	1.3-5.1	F	140	51%	100%												
	0.09	35	35	3.5-14	2.3-9.2	1.7-6.9	1.4-5.5	F	136	53%	100%												
	0.10	40	40	3.8-15	2.5-9.9	1.9-7.4	1.5-5.9	F	133	56%	100%												
	0.11	45	45	4-16	2.5-10	2-7.9	1.6-6.3	F	131	58%	100%												
	0.11	50	50	4.3-17	2.8-11	2.1-8.3	1.7-6.6	F	128	59%	100%												
	0.12	60	60	4.5-18	3-12	2.3-9.1	1.8-7.3	F	124	62%	100%												
	0.13	65	65	4.8-19	3.3-13	2.4-9.4	1.9-7.6	F	123	63%	100%												
	0.13	70	70	5-20	3.3-13	2.5-9.8	2-7.8	F	121	65%	100%												
	0.14	80	80	5.3-21	3.5-14	2.5-10	2.1-8.4	F	118	67%	100%												
	110-015 Nozzles	Flow us gpm	Boom psi	Tip psi	Sprayer Speed (on 20" spacing) @					ER110-015	#40281-015	SR110-015	#40287-015	MR110-015	#40291-015	DR110-015	#40286-015						
		0.11	20	20	2.5-10	2.5-10	1.6-6.3	1.3-5.2	F	153	40%	100%											
0.12		25	25	3-12	2.2-8.8	1.8-7	1.5-5.8	F	148	44%	100%	M	226	21%	98%								
0.13		30	30	3.3-13	2.4-9.6	1.9-7.7	1.6-6.4	F	145	47%	100%	F	216	24%	98%	C	323	11%	94%	C	368	7%	92%
0.14		35	35	3.5-14	2.5-10	2.1-8.3	1.7-6.9	F	142	49%	100%	F	207	26%	98%	C	298	14%	96%	C	346	8%	93%
0.15		40	40	3.8-15	2.8-11	2.2-8.9	1.9-7.4	F	139	51%	100%	F	200	28%	98%	C	279	16%	97%	C	329	10%	94%
0.16		45	45	4-16	3-12	2.4-9.4	2-7.8	F	137	53%	100%	F	194	30%	98%	M	262	18%	98%	C	315	11%	95%
0.17		50	50	4.3-17	3-12	2.5-9.9	2.1-8.3	F	135	55%	100%	F	188	32%	98%	M	248	20%	98%	C	302	12%	95%
0.18		60	60	4.5-18	3.5-14	2.8-11	2.3-9.1	F	131	58%	100%	F	178	34%	98%	M	226	23%	99%	C	282	14%	96%
0.19		65	64	4.8-19	3.5-14	2.8-11	2.4-9.4	F	129	59%	100%	F	173	36%	98%	F	217	24%	99%	C	273	15%	96%
0.20		70	69	5-20	3.8-15	3-12	2.5-9.8	F	128	61%	100%	F	169	37%	98%	F	209	25%	99%	M	265	15%	97%
0.21		80	79	5.3-21	4-16	3.3-13	2.5-10	F	125	63%	100%	F	162	39%	98%	F	195	27%	100%	M	252	17%	97%
110-02 Nozzles		Flow us gpm	Boom psi	Tip psi	Sprayer Speed (on 20" spacing) @					ER110-02	#40281-02	SR110-02	#40287-02	MR110-02	#40291-02	DR110-02	#40286-02						
		0.14	20	20	3.5-14	2.5-10	2.1-8.3	1.7-6.9	F	173	32%	100%											
	0.16	25	25	4-16	3-12	2.3-9.3	2-7.8	F	166	36%	100%	M	228	20%	99%								
	0.17	30	29	4.3-17	3.3-13	2.5-10	2.1-8.5	F	160	39%	100%	M	220	22%	99%	C	317	11%	95%	VC	433	5%	82%
	0.19	35	34	4.5-18	3.5-14	2.8-11	2.3-9.2	F	155	42%	100%	F	213	24%	99%	C	297	13%	96%	VC	412	6%	85%
	0.20	40	39	5-20	3.8-15	3-12	2.5-9.8	F	151	45%	100%	F	207	26%	99%	C	281	15%	97%	VC	394	6%	87%
	0.21	45	44	5.3-21	4-16	3-12	2.5-10	F	147	47%	100%	F	202	27%	99%	M	267	17%	97%	C	378	7%	88%
	0.22	50	49	5.5-22	4-16	3.3-13	2.8-11	F	144	49%	100%	F	197	28%	99%	M	256	18%	97%	C	364	8%	90%
	0.24	60	59	6-24	4.5-18	3.5-14	3-12	F	138	52%	100%	F	189	31%	99%	M	237	21%	98%	C	339	9%	91%
	0.25	65	64	6.3-25	4.8-19	3.8-15	3.3-13	F	136	54%	100%	F	185	32%	99%	M	229	22%	98%	C	328	10%	92%
	0.26	70	69	6.5-26	4.8-19	4-16	3.3-13	F	133	55%	100%	F	182	32%	99%	M	222	23%	98%	C	318	10%	93%
	0.28	80	79	7-28	5.3-21	4.3-17	3.5-14	F	129	58%	100%	F	176	34%	99%	F	210	25%	99%	C	299	11%	94%
	110-025 Nozzles	Flow us gpm	Boom psi	Tip psi	Sprayer Speed (on 20" spacing) @					ER110-025	#40281-025	SR110-025	#40287-025	MR110-025	#40291-025	DR110-025	#40286-025	UR110-025					
		0.17	20	19	4.3-17	3.3-13	2.5-10	2.2-8.6	F	194	28%	100%						#40292-025					
0.20		25	24	4.8-19	3.5-14	3-12	2.4-9.7	F	190	29%	100%	M	246	17%	98%								
0.21		30	29	5.3-21	4-16	3.3-13	2.8-11	F	187	29%	100%	M	237	19%	98%	C	353	8%	90%	VC	437	5%	79%
0.23		35	34	5.8-23	4.3-17	3.5-14	2.8-11	F	184	29%	100%	M	230	21%	98%	C	337	10%	92%	VC	418	6%	83%
0.25		40	39	6-24	4.5-18	3.8-15	3-12	F	181	30%	100%	M	223	22%	98%	C	322	11%	93%	VC	401	6%	86%
0.26		45	44	6.5-26	4.8-19	4-16	3.3-13	F	179	30%	100%	M	218	24%	98%	C	310	12%	94%	C	386	7%	88%
0.28		50	49	6.8-27	5-20	4-16	3.5-14	F	177	30%	100%	F	213	25%	98%	C	299	13%	95%	C	373	8%	89%
0.30		60	58	7.5-30	5.5-22	4.5-18	3.8-15	F	173	31%	100%	F	204	27%	98%	C	280	15%	96%	C	350	9%	91%
0.31		65	63	7.8-31	5.8-23	4.8-19	4-16	F	172	31%	100%	F	200	28%	98%	C	271	16%	96%	C	340	9%	92%
0.33		70	68	8-32	6-24	4.8-19	4-16	F	170	31%	100%	F	196	28%	98%	M	263	16%	96%	C	331	10%	93%
0.35		80	78	8.8-35	6.5-26	5.3-21	4.3-17	F	168	31%	100%	F	190	30%	98%	M	249	18%	97%	C	314	10%	94%
110-03 Nozzles		Flow us gpm	Boom psi	Tip psi	Sprayer Speed (on 20" spacing) @					ER110-03	#40281-03	SR110-03	#40287-03	MR110-03	#40291-03	DR110-03	#40286-03	UR110-03					
		0.21	20	19	3.8-15	3-12	2.5-10	1.9-7.7	F	199	26%	99%						#40292-03					
	0.23	25	24	4.3-17	3.5-14	3-12	2.2-8.6	F	191	29%	99%	C	322	9%	93%								
	0.26	30	29	4.8-19	3.8-15	3.3-13	2.4-9.5	F	185	31%	99%	C	307	11%	95%	VC	399	6%	86%				
	0.28	35	34	5-20	4-16	3.5-14	2.5-10	F	179	33%	98%	C	293	13%	95%	C	380	7%	88%	XC	464	4%	77%
	0.29	40	39	5.5-22	4.3-17	3.8-15	2.8-11	F	175	34%	98%	C	282	14%	96%	C	364	8%	90%	VC	447	5%	79%
	0.31	45	43	5.8-23	4.8-19	3.8-15	3-12	F	170	36%	98%	C	272	16%	96%	C	350	9%	91%	VC	432	5%	82%
	0.33	50	48	6-24	5-20	4-16	3-12	F	167	37%	98%	M	263	17%	97%	C	337	10%	93%	VC	419	6%	83%
	0.36	60	58	6.8-27	5.3-21	4.5-18	3.3-13	F	160	39%	97%	M	247	19%	97%	C	315	11%	94%	C	396	6%	86%
	0.38	65	63	7-28	5.5-22	4.8-19	3.5-14	F	157	40%	97%	M	240	20%	97%	C	306	12%	95%	C	385	7%	87%
	0.39	70	68	7.3-29	5.8-23	4.8-19	3.5-14	F	155	41%	97%	M	234	20%	97%	C	297	13%	95%	C	376	7%	88%
	0.42	80	77	7.8-31	6.3-25	5.3-21	3.8-15	F	150	42%	97%	M	223	22%	98%	C	281	14%	96%				

COMBO-JET® Metering Orifices & Fertilizer Streamer Caps

NOZZLES

COMBO-JET® Fertilizer Streamer Caps

Color-coded 3-hole streamer nozzles designed for streaming liquid fertilizer on consistent spacing to minimize leaf burn.

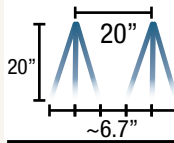

Operating Pressure	10-60 PSI
O-rings	FKM (viton avail.)
Material	Glass-reinforced Polypropylene

Cap Includes:



COMBO-JET® Metering Orifices

Metering orifice snap into any Combo-Jet or Radialock caps to meter fertilizer or chemical flow rates.

40249-00
50 Mesh Strainer



LONG ORIFICE
Available in -08 size & up

SHORT

Short style orifices are compatible with Combo-Jet snap-in strainers.

40285-04 40285-15

*Some metering orifices have long stems, as they do not require strainers

UR series Orifices

If you are looking for replacement two-piece pre-orifices for Combo-Jet UR series spray tips, visit the UR series spray tip page for part numbers.



40292-27

Combo-Jet Streamer Nozzle Size	Metering Orifice Size	Pres. (PSI)	Flow Rate (us gpm)	10" Outlet Spacing			12" Outlet Spacing			15" Outlet Spacing			20" Outlet Spacing			30" Outlet Spacing		
				Application Rates (GPA) @														
				4.5 MPH	5.0 MPH	6.5 MPH	4.5 MPH	5.0 MPH	6.5 MPH	4.5 MPH	5.0 MPH	6.5 MPH	7.5 MPH	10 MPH	15 MPH	4.5 MPH	5.0 MPH	6.5 MPH
Using Tip Wizard makes selecting metering orifices & streamer caps easy! TRY IT FREE AT WWW.WILGER.NET Download on the App Store GET IT ON Google Play	-005 COMBO-JET Metering Orifice 40285-005	15	0.03	4.0	3.6	2.8	3.3	3.0	2.3	2.7	2.4	1.9	1.4	1.0	0.7	1.3	1.2	0.9
		20	0.04	4.6	4.2	3.2	3.9	3.5	2.7	3.1	2.8	2.1	1.6	1.2	0.8	1.5	1.4	1.1
		25	0.04	5.2	4.7	3.6	4.3	3.9	3.0	3.5	3.1	2.4	1.7	1.3	0.9	1.7	1.6	1.2
		30	0.04	5.7	5.1	3.9	4.7	4.3	3.3	3.8	3.4	2.6	1.8	1.4	0.9	1.9	1.7	1.3
		35	0.05	6.1	5.5	4.2	5.1	4.6	3.5	4.1	3.7	2.8	2	1.5	1	2.0	1.8	1.4
		40	0.05	6.6	5.9	4.5	5.5	4.9	3.8	4.4	3.9	3.0	2.1	1.6	1	2.2	2.0	1.5
		45	0.05	7.0	6.3	4.8	5.8	5.2	4.0	4.6	4.2	3.2	2.2	1.6	1.1	2.3	2.1	1.6
		15	0.04	5.4	4.9	3.7	4.5	4.1	3.1	3.6	3.2	2.5	1.9	1.4	0.9	1.8	1.6	1.2
		20	0.05	6.3	5.6	4.3	5.2	4.7	3.6	4.2	3.8	2.9	2.1	1.6	1	2.1	1.9	1.4
		25	0.05	7.0	6.3	4.8	5.8	5.2	4.0	4.7	4.2	3.2	2.3	1.7	1.1	2.3	2.1	1.6
		30	0.06	7.7	6.9	5.3	6.4	5.7	4.4	5.1	4.6	3.5	2.5	1.9	1.2	2.6	2.3	1.8
		35	0.06	8.3	7.4	5.7	6.9	6.2	4.8	5.5	5.0	3.8	2.7	2	1.3	2.8	2.5	1.9
		40	0.07	8.8	8.0	6.1	7.4	6.6	5.1	5.9	5.3	4.1	2.8	2.1	1.4	2.9	2.7	2.0
		45	0.07	9.4	8.4	6.5	7.8	7.0	5.4	6.3	5.6	4.3	3	2.2	1.5	3.1	2.8	2.2
		15	0.06	8.1	7.3	5.6	6.8	6.1	4.7	5.4	4.9	3.7	2.8	2.1	1.4	2.7	2.4	1.9
20	0.07	9.4	8.4	6.5	7.8	7.0	5.4	6.3	5.6	4.3	3.1	2.4	1.6	3.1	2.8	2.2		
25	0.08	10	9.4	7.3	8.7	7.9	6.0	7.0	6.3	4.8	3.4	2.6	1.7	3.5	3.1	2.4		
30	0.09	11	10	8	10	8.6	6.6	7.7	6.9	5.3	3.7	2.8	1.9	3.8	3.4	2.7		
35	0.09	12	11	9	10	9.3	7.2	8.3	7.4	5.7	4	3	2	4.1	3.7	2.9		
40	0.10	13	12	9	11	10	7.7	8.8	8.0	6.1	4.2	3.2	2.1	4.4	4.0	3.1		
45	0.11	14	13	10	12	11	8.1	9.4	8.4	6.5	4.4	3.3	2.2	4.7	4.2	3.2		
40443-015	-015 COMBO-JET Metering Orifice 40285-015	15	0.09	12	11	8.4	10	9.1	7.0	8.1	7.3	5.6	4.2	3.2	2.1	4.0	3.6	2.8
		20	0.11	14	13	10	12	11	8.1	9.3	8.4	6.5	4.7	3.5	2.3	4.7	4.2	3.2
		25	0.12	16	14	11	13	12	9.0	10	9.4	7.2	5.1	3.9	2.6	5.2	4.7	3.6
		30	0.13	17	15	12	14	13	10	11	10	7.9	5.6	4.2	2.8	5.7	5.1	4.0
		35	0.14	19	17	13	15	14	11	12	11	8.6	5.9	4.5	3	6.2	5.6	4.3
		40	0.15	20	18	14	17	15	11	13	12	9.1	6.3	4.7	3.2	6.6	5.9	4.6
40443-02	-02 COMBO-JET Metering Orifice 40285-02	15	0.12	16	15	11	13	12	9.3	11	10	7.4	5.6	4.2	2.8	5.4	4.8	3.7
		20	0.14	19	17	13	16	14	11	12	11	8.6	6.2	4.7	3.1	6.2	5.6	4.3
		25	0.16	21	19	14	17	16	12	14	12	10	6.8	5.1	3.4	6.9	6.2	4.8
		30	0.17	23	21	16	19	17	13	15	14	11	7.4	5.5	3.7	7.6	6.8	5.3
		35	0.19	25	22	17	21	18	14	16	15	11	7.9	5.9	4	8.2	7.4	5.7
		40	0.20	26	24	18	22	20	15	18	16	12	8.4	6.3	4.2	8.8	7.9	6.1
40443-025	-025 COMBO-JET Metering Orifice 40285-025	15	0.15	20	18	14	17	15	12	13	12	9.3	7	5.2	3.5	6.7	6.1	4.7
		20	0.18	23	21	16	19	17	13	16	14	11	7.8	5.9	3.9	7.8	7.0	5.4
		25	0.20	26	23	18	22	20	15	17	16	12	8.6	6.4	4.3	8.7	7.8	6.0
		30	0.22	29	26	20	24	21	16	19	17	13	9.2	6.9	4.6	10	8.6	6.6
		35	0.23	31	28	21	26	23	18	21	18	14	9.9	7.4	4.9	10	9.2	7.1
		40	0.25	33	30	23	27	25	19	22	20	15	10	7.9	5.2	11	10	7.6
40443-03	-03 COMBO-JET Metering Orifice 40285-03	15	0.18	24	22	17	20	18	14	16	15	11	8.4	6.3	4.2	8.1	7.3	5.6
		20	0.21	28	25	19	23	21	16	19	17	13	9.4	7	4.7	9.3	8.4	6.5
		25	0.24	31	28	22	26	23	18	21	19	14	10	7.7	5.1	10	9.4	7.2
		30	0.26	34	31	24	29	26	20	23	21	16	11	8.3	5.6	11	10	7.9
		35	0.28	37	33	26	31	28	21	25	22	17	12	8.9	5.9	12	11	8.6
		40	0.30	40	36	27	33	30	23	26	24	18	13	9.5	6.3	13	12	9.1
40443-04	-04 COMBO-JET Metering Orifice 40285-04	15	0.24	32	29	22	27	24	19	22	19	15	11	8.4	5.6	11	10	7.5
		20	0.28	37	34	26	31	28	22	25	22	17	13	9.4	6.3	12	11	8.6
		25	0.32	42	38	29	35	31	24	28	25	19	14	10	6.9	14	13	10
		30	0.35	46	41	32	38	34	26	30	27	21	15	11	7.4	15	14	11
		35	0.37	49	44	34	41	37	28	33	30	23	16	12	7.9	16	15	11
		40	0.40	53	47	37	44	40	30	35	32	24	17	13	8.4	18	16	12
40443-05	-05 COMBO-JET Metering Orifice 40285-05	15	0.31	40	36	28	34	30	23	27	24	19	12	9.1	6.1	13	12	9.3
		20	0.35	47	42	32	39	35	27	31	28	22	14	11	7	16	14	11
		25	0.40	52	47	36	43	39	30	35	31	24	16	12	7.8	17	16	12
		30	0.43	57	51	40	48	43	33	38	34	26	17	13	8.6	19	17	13
		35	0.47	62	56	43	51	46	36	41	37	28	19	14	9.3	21	19	14
		40	0.50	66	59	46	55	49	38	44	40	30	20	15	9.9	22	20	15
45	0.53	70	63	48	58	53	40	47	42	32	21	16	11	23	21	16		

COMBO-JET® Metering Orifices (cont'd)







Common Liquid Weight, Specific Gravity, and Conversion Factor for Flow Rate:

[WATER] 8.34 lbs/gal
Specific Gravity 1.0
Conversion Factor: 1.00

[28-0-0] 10.67 lbs/gal
Specific Gravity 1.28
Conversion Factor: 1.13

[10-34-0] 11.65 lbs/gal
Specific Gravity 1.28
Conversion Factor: 1.18

Required Flow Rate x Conversion Factor = Flow Rate adjusted for density

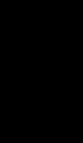
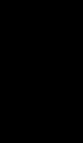
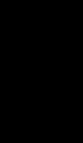
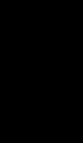
Metering Orifice Size	Pres. (PSI)	Flow Rate (us gpm)	10" Outlet Spacing			12" Outlet Spacing			15" Outlet Spacing			20" Outlet Spacing			30" Outlet Spacing			
			Application Rates (GPA) @			Application Rates (GPA) @			Application Rates (GPA) @			Application Rates (GPA) @			Application Rates (GPA) @			
			4.5 MPH	5.0 MPH	6.5 MPH	4.5 MPH	5.0 MPH	6.5 MPH	4.5 MPH	5.0 MPH	6.5 MPH	7.5 MPH	10 MPH	15 MPH	4.5 MPH	5.0 MPH	6.5 MPH	
 40443-06	-06	15	0.37	49	44	34	40	36	28	32	29	22	15	11	7.3	16	15	11
		20	0.42	56	50	39	47	42	32	37	34	26	17	13	8.4	19	17	13
		25	0.47	63	56	43	52	47	36	42	38	29	19	14	9.4	21	19	14
		30	0.52	69	62	48	57	51	40	46	41	32	21	15	10	23	21	16
		35	0.56	74	67	51	62	56	43	49	44	34	22	17	11	25	22	17
		40	0.60	79	71	55	66	59	46	53	48	37	24	18	12	26	24	18
 40443-08	-08	15	0.49	65	58	45	54	49	37	43	39	30	19	15	9.7	22	19	15
		20	0.57	75	67	52	62	56	43	50	45	34	22	17	11	25	22	17
		25	0.63	84	75	58	70	63	48	56	50	39	25	19	13	28	25	19
		30	0.69	91	82	63	76	69	53	61	55	42	27	21	14	30	27	21
		35	0.75	99	89	68	82	74	57	66	59	46	30	22	15	33	30	23
		40	0.80	106	95	73	88	79	61	70	63	49	32	24	16	35	32	24
 40443-10	-10	15	0.62	81	73	56	68	61	47	54	49	37	24	18	12	27	24	19
		20	0.71	94	84	65	78	70	54	63	56	43	28	21	14	31	28	22
		25	0.79	105	94	73	87	79	60	70	63	48	31	24	16	35	31	24
		30	0.87	115	103	80	96	86	66	77	69	53	34	26	17	38	34	27
		35	0.94	124	112	86	103	93	72	83	74	57	37	28	19	41	37	29
		40	1.00	133	119	92	111	99	77	88	80	61	40	30	20	44	40	31
 40443-125	-125	15	0.76	101	91	70	84	76	58	67	60	47	30	23	15	34	30	23
		20	0.88	116	105	81	97	87	67	78	70	54	35	26	17	39	35	27
		25	0.99	130	117	90	108	98	75	87	78	60	39	29	20	43	39	30
		30	1.08	143	128	99	119	107	82	95	86	66	43	32	21	48	43	33
		35	1.17	154	139	107	128	115	89	103	92	71	46	35	23	51	46	36
		40	1.25	165	148	114	137	123	95	110	99	76	49	37	25	55	49	38
 40443-15	-15	15	0.92	121	109	84	101	91	70	81	73	56	36	27	18	40	36	28
		20	1.06	140	126	97	117	105	81	93	84	65	42	32	21	47	42	32
		25	1.19	157	141	108	131	117	90	104	94	72	47	35	23	52	47	36
		30	1.30	172	154	119	143	129	99	114	103	79	51	39	26	57	51	40
		35	1.40	185	167	128	154	139	107	124	111	86	56	42	28	62	56	43
		40	1.50	198	178	137	165	149	114	132	119	91	59	45	30	66	59	46
 40443-20	-20	15	1.22	161	145	112	135	121	93	108	97	75	48	36	24	54	48	37
		20	1.41	186	168	129	155	140	108	124	112	86	56	42	28	62	56	43
		25	1.58	208	188	144	174	156	120	139	125	96	63	47	31	69	63	48
		30	1.73	228	206	158	190	171	132	152	137	105	69	51	34	76	69	53
		35	1.87	247	222	171	206	185	142	164	148	114	74	55	37	82	74	57
		40	2.00	264	237	183	220	198	152	176	158	122	79	59	40	88	79	61
 40443-25	-25	15	1.53	202	182	140	168	152	117	135	121	93	61	45	30	67	61	47
		20	1.77	233	210	162	194	175	135	156	140	108	70	53	35	78	70	54
		25	1.98	261	235	181	217	196	151	174	157	120	78	59	39	87	78	60
		30	2.17	286	257	198	238	214	165	191	171	132	86	64	43	95	86	66
		35	2.34	309	278	214	257	232	178	206	185	142	93	69	46	103	93	71
		40	2.50	330	297	228	275	247	190	220	198	152	99	74	49	110	99	76
 40443-30	-30	15	1.84	243	218	168	202	182	140	162	146	112	73	55	36	81	73	56
		20	2.12	280	252	194	234	210	162	187	168	129	84	63	42	93	84	65
		25	2.37	313	282	217	261	235	181	209	188	145	94	70	47	104	94	72
		30	2.60	343	309	238	286	257	198	229	206	158	103	77	51	114	103	79
		35	2.81	371	334	257	309	278	214	247	222	171	111	83	56	124	111	86
		40	3.00	396	357	274	330	297	229	264	238	183	119	89	59	132	119	91
 40443-40	-40	15	2.45	323	291	224	269	242	186	215	194	149	97	73	48	108	97	75
		20	2.83	373	336	258	311	280	215	249	224	172	112	84	56	124	112	86
		25	3.16	417	375	289	347	313	241	278	250	192	125	94	63	139	125	96
		30	3.46	457	411	316	381	343	263	304	274	211	137	103	69	152	137	105
		35	3.74	493	444	342	411	370	285	329	296	228	148	111	74	164	148	114
		40	4.00	527	475	365	439	396	304	352	316	243	158	119	79	176	158	122
 40443-50	-50	15	3.06	405	364	280	337	303	233	270	243	187	121	91	61	135	121	93
		20	3.54	467	420	323	389	350	269	311	280	216	140	105	70	156	140	108
		25	3.96	522	470	362	435	392	301	348	313	241	157	118	78	174	157	121
		30	4.33	572	515	396	477	429	330	381	343	264	172	129	86	191	172	132
		35	4.68	618	556	428	515	463	356	412	371	285	185	139	93	206	185	143
		40	5.00	661	595	457	550	495	381	440	396	305	198	149	99	220	198	152
	45	5.31	701	631	485	584	525	404	467	420	323	210	158	105	234	210	162	

NEW

COMBO-JET® Narrow-Angle Nozzles for Specialty/Spot Spraying

**N
O
Z
Z
L
E
S**

A full selection of narrow angle spray nozzles for use in specialty applications that require a narrow, but thick pattern. These nozzles are fully compatible with PWM spray systems, and other optical spray systems. Contact factory for availability.

COMBO-JET® ER & DX Series of 20°, 40° & 60° Spray Nozzles for Optical & Spot Spraying

A new series of DX drift reduction, narrow angle nozzles.

Nozzle Size & Angle	Flow Rate us gpm	Boom PSI	Application Rate in Gallons/Acre on 10inch Nozzle Spacing						20° Nozzles	40° Nozzles	60° Nozzles
			@ Sprayer Speed in mph								
For smaller sizes of nozzles in narrow-angle varieties, please contact Wilger. As spot-spraying systems continue to develop, Wilger expects to have a variety of nozzles developed to support the new improvements to maximize effectiveness.											
-015 Nozzles	Flow us gpm	Boom PSI	Sprayer Speed (on 10inch spacing) @						Drift Reduction	Drift Reduction	Drift Reduction
			5gpa	8gpa	10gpa	13gpa	15gpa	18gpa	DX20-015	DX40-015	DX60-015
	0.130	30	15	10	8	5.9	5.1	4.3	#42220-015	#42240-015	#42260-015
	0.150	40	18	11	9	7	5.9	5.0	Fine Spray ER20-015	Fine Spray ER40-015	Fine Spray ER60-015
	0.168	50	20	12	10	8	7	5.5	#42120-015	#42140-015	#42160-015
0.184	60	22	14	11	8	7	6.1				
0.198	70	24	15	12	9	8	7				
-02 Nozzles	Flow us gpm	Boom PSI	Sprayer Speed (10in spacing) @						Drift Reduction	Drift Reduction	Drift Reduction
			8gpa	10gpa	13gpa	15gpa	18gpa	20gpa	DX20-02	DX40-02	DX60-02
	0.173	30	13	10	8	7	5.7	5.1	#42220-02	#42240-02	#42260-02
	0.200	40	15	12	9	8	7	6	Fine Spray ER20-02	Fine Spray ER40-02	Fine Spray ER60-02
	0.224	50	17	13	10	9	7	7	#42120-02	#42140-02	#42160-02
0.245	60	18	15	11	10	8	7				
0.265	70	20	16	12	10	9	8				
-025 Nozzles	Flow us gpm	Boom PSI	Sprayer Speed (on 10in spacing) @						Drift Reduction	Drift Reduction	Drift Reduction
			10gpa	12gpa	15gpa	18gpa	20gpa	23gpa	DX20-025	DX40-025	DX60-025
	0.217	30	13	11	9	7	6	5.6	#42220-025	#42240-025	#42260-025
	0.250	40	15	12	10	8	7	7	Fine Spray ER20-025	Fine Spray ER40-025	Fine Spray ER60-025
	0.280	50	17	14	11	9	8	7	#42120-025	#42140-025	#42160-025
0.306	60	18	15	12	10	9	8				
0.331	70	20	16	13	11	10	9				
-03 Nozzles	Flow us gpm	Boom PSI	Sprayer Speed (on 10in spacing) @						Drift Reduction	Drift Reduction	Drift Reduction
			13gpa	15gpa	18gpa	20gpa	23gpa	25gpa	DX20-03	DX40-03	DX60-03
	0.260	30	12	10	9	8	7	6	#42220-03	#42240-03	#42260-03
	0.300	40	14	12	10	9	8	7	Fine Spray ER20-03	Fine Spray ER40-03	Fine Spray ER60-03
	0.335	50	15	13	11	10	9	8	#42120-03	#42140-03	#42160-03
0.367	60	17	15	12	11	10	9				
0.397	70	18	16	13	12	10	9				
-04 Nozzles	Flow us gpm	Boom PSI	Sprayer Speed (on 10in spacing) @						Drift Reduction	Drift Reduction	Drift Reduction
			15gpa	20gpa	25gpa	28gpa	30gpa	33gpa	DX20-04	DX40-04	DX60-04
	0.346	30	14	10	8	7	7	6	#42220-04	#42240-04	#42260-04
	0.400	40	16	12	10	9	8	7	Fine Spray ER20-04	Fine Spray ER40-04	Fine Spray ER60-04
	0.447	50	18	13	11	10	9	8	#42120-04	#42140-04	#42160-04
0.490	60	19	15	12	10	10	9				
0.529	70	21	16	13	11	10	10				
-05 Nozzles	Flow us gpm	Boom PSI	Sprayer Speed (on 10in spacing) @						Drift Reduction	Drift Reduction	Drift Reduction
			18gpa	20gpa	25gpa	30gpa	35gpa	38gpa	DX20-05	DX40-05	DX60-05
	0.43	30	14	13	10	9	7	7	#42220-05	#42240-05	#42260-05
	0.50	40	17	15	12	10	9	8	Fine Spray ER20-05	Fine Spray ER40-05	Fine Spray ER60-05
	0.56	50	18	17	13	11	10	9	#42120-05	#42140-05	#42160-05
0.61	60	20	18	15	12	10	10				
0.66	70	22	20	16	13	11	10				
-06 Nozzles	Flow us gpm	Boom PSI	Sprayer Speed (on 10in spacing) @						Drift Reduction	Drift Reduction	Drift Reduction
			20gpa	25gpa	30gpa	35gpa	40gpa	45gpa	DX20-06	DX40-06	DX60-06
	0.52	30	15	12	10	9	8	7	#42220-06	#42240-06	#42260-06
	0.60	40	18	14	12	10	9	8	Fine Spray ER20-06	Fine Spray ER40-06	Fine Spray ER60-06
	0.67	50	20	16	13	11	10	9	#42120-06	#42140-06	#42160-06
0.73	60	22	17	15	12	11	10				
0.79	70	24	19	16	13	12	10				
-08 Nozzles	Flow us gpm	Boom PSI	Sprayer Speed (on 10in spacing) @						Drift Reduction	Drift Reduction	Drift Reduction
			30gpa	35gpa	40gpa	45gpa	50gpa	55gpa	DX20-08	DX40-08	DX60-08
	0.69	30	14	12	10	9	8	8	#42220-08	#42240-08	#42260-08
	0.80	40	16	14	12	11	10	9	Fine Spray ER20-08	Fine Spray ER40-08	Fine Spray ER60-08
	0.89	50	18	15	13	12	11	10	#42120-08	#42140-08	#42160-08
0.98	60	19	17	15	13	12	11				
1.06	70	21	18	16	14	13	11				
-10 Nozzles	Flow us gpm	Boom PSI	Sprayer Speed (on 10in spacing) @						Drift Reduction	Drift Reduction	Drift Reduction
			40gpa	45gpa	50gpa	60gpa	65gpa	70gpa	DX20-10	DX40-10	DX60-10
	0.87	30	13	11	10	9	8	7	#42220-10	#42240-10	#42260-10
	1.00	40	15	13	12	10	9	9	Fine Spray ER20-10	Fine Spray ER40-10	Fine Spray ER60-10
	1.12	50	17	15	13	11	10	10	#42120-10	#42140-10	#42160-10
1.22	60	18	16	15	12	11	10				
1.32	70	20	17	16	13	12	11				
-125 Nozzles	Flow us gpm	Boom PSI	Sprayer Speed (on 10in spacing) @						Drift Reduction	Drift Reduction	Drift Reduction
			50gpa	60gpa	70gpa	80gpa	90gpa	100	DX20-125	DX40-125	DX60-125
	1.08	30	13	11	9	8	7	6	#42220-125	#42240-125	#42260-125
	1.25	40	15	12	11	9	8	7	Fine Spray ER20-125	Fine Spray ER40-125	Fine Spray ER60-125
	1.40	50	17	14	12	10	9	8	#42120-125	#42140-125	#42160-125
1.53	60	18	15	13	11	10	9				
1.65	70	20	16	14	12	11	10				

For larger sizes of nozzles in narrow-angle varieties, please contact Wilger. As spot-spraying systems continue to develop, Wilger expects to have a variety of nozzles developed in turn to support the new improvements to maximize effectiveness.

What is optical spot spraying?

Optical spraying systems, or spot spraying based on optical feedback is used for a variety of purposes and with different modes of action.

Spray on Green

Optics identify 'green' targets in field, and sprays them.

- Pre-plant spraying to clear out established weeds
- Spraying fungicide on plants in field, ignoring dirt.
- Using modes of actions to manage resistant weeds.
- Foliar fertilizer applications on plant only

Green on Green

Optics & computer differentiate plants in field and spray target plants only.

- Spraying weeds ONLY, avoiding planted crop.
- Spraying crop with fungicide, ignoring weeds.
- Spraying different weeds with different chemicals

While the potential benefits of **Green on Green** provide a great deal of flexibility & means to use cost-prohibitive herbicide regimens, the means to differentiate plants at application time and development of the computing power and learning mechanisms are continually under development.

What is the DX series of spray tip?

Effectively through development of the narrow angle nozzles, there seems to be a relative sweet spot for consistent coverage and maintaining a reasonable level of driftable fines.

Since optical/spot sprayers are commonly sharing a maximum speed and narrow spacing, it is easier to consolidate what Wilger finds as a good middle ground to offer a single drift reduction nozzle.

That being said, if you have a significant need for a coarser option than the DX nozzle, by all means contact Wilger and we would likely have something that might be made available to you.

Other uses for narrow-angle nozzles

Narrow angle spray nozzles are also key in improving some non-broadcast spraying.

Narrower angle nozzles can be used in applications that specifically target certain parts of the plant where application to the rest of the plant is waste.

There are also cropping applications that might be continually cropping into **high stubble**, where traditional wide angle nozzles will result in significant spray catch and run-off in the stubble.

It is important to recognize narrow angle nozzles are not to be used strictly as replacements for nozzles that are intended for your sprayer (e.g. 80° or 110°). They are only an option to further isolate and target a spray target to achieve better spray efficiency and minimize chemical waste.

Are they still PWM-compatible?



Absolutely!

The narrow angles use the same drift reduction design that is completely compatible with optical spray systems that are typically driven by PWM solenoids. The consistent thickness of the narrow angles make the key choices for optical spot sprayers for both compatibility and performance.

Are DX nozzles used on Drone Sprayers?

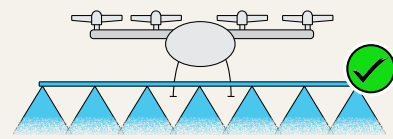

UAV sprayer applicators ARE able to use DX nozzles for targeted spray applications, but often due to boom constraints, required swath width or UAV sprayer outfitting, wider angle nozzles like the MR110° nozzles might be used. Operators in special circumstances that require a very narrow spray swath can take advantage of the DX series of narrow-angle nozzles.

DX nozzles can be used on UAV sprayers, but they would likely be specialty applications or on sprayers that require very narrow spacing. Contact WILGER offices for smaller sizes of DX nozzles for Drone applications.

COMBO-JET® Cap Adapters





Order #####-V0 for viton o-ring assemblies

Wilger manufactures a variety of adapters to adapt Wilger nozzles to other brands of nozzle bodies (e.g. Teejet, Hypro, Arag, etc) and vice versa. All adapters self-align cap to common nozzle offset.

<p>Square Lug to COMBO-JET®</p>  <p>40204-00 Converts Square Lug (e.g. Teejet/Hypro) Outlet to COMBO-JET -TWISTLOCK-</p>	<p>AGRIFAC to COMBO-JET</p> <p><i>New</i></p>  <p>40205-00 Converts Agrifac Outlet to COMBO-JET -Easy nozzle sleeve-snaps into Combo-Jet caps</p>	<p>JACTO to COMBO-JET</p> <p><i>New</i></p>  <p>40207-00 Converts Jacto Outlet to COMBO-JET -Quarter Turn-</p>
<p>Square Lug to DOUBLE-DOWN</p> <p><i>New</i></p>  <p>40206-00 Converts Square Lug Outlet to COMBO-JET Double-Down Outlets -TWISTLOCK-</p>	<p>AGRIFAC to Y-Adapter</p> <p><i>New</i></p>  <p>40213-00 Converts Agrifac Outlet to COMBO-JET Y-adapter Outlets -TWISTLOCK-</p> <p><small>*AG* molded into the cap designates for Agrifac outlet only</small></p>	<p>HARDI to COMBO-JET</p>  <p>40202-00 Converts HARDI Outlet to COMBO-JET -Semi-permanent snap on adapter-</p>
<p>COMBO-JET to Square Lug</p>  <p>40203-00 Converts COMBO-JET Outlet to Square Lug (e.g. Teejet/Hypro) -Quarter Turn-</p>		

Radialock Slotted Caps (Compatible with COMBO-JET outlets)

Wilger manufactures a variety of caps for accepting flanged spray tips onto any Combo-Jet or Combo-Rate nozzle outlets. These caps require a spray tip gasket to seal, which is sold separately.

<p>Gasket for Slotted Caps</p>  <p>40160-00 EPDM Rubber Gasket for Flanged Tips & Radialock slotted caps Order 40160-V0 for viton gasket</p>	<p>3/8" Slot</p> <p>3/8" TIP</p>  <p>For 3/8" Teejet/Hypro spray tips 40269-05</p>	<p>1/2" Round Slot</p> <p>1/2" TIP</p>  <p>For 1/2" round spray tips 40271-05</p>	<p>7/16" Wide Slot</p> <p>7/16" TIP</p>  <p>For larger Teejet/Hypro spray tips 40276-05</p>	<p>HARDI Tip Slot</p> <p>HARDI TIP</p>  <p>For HARDI brand spray tips 40275-05</p>
<p>Available in colors: Grey (-09), Orange (-08), Brown (-07), Blue (-06), Black (-05), Yellow (-04), Green (-03), White (-02), Red (-01)</p>		<p>Available in colors*: Black (-05), Yellow (-04), Green (-03), White (-02), Red (-01) *Check factory availability of non-black colors.</p>		

Conventional Flat Fan Flanged Spray Tips (3/8" slot)

Wilger manufactures a variety of sizes of flanged stainless steel spray tips inserted permanently into a flanged spray tip assembly. These would correspond to Combo-Jet ER series of spray nozzle, as they are a conventional flat fan tip.

ER 80° Flanged Tips

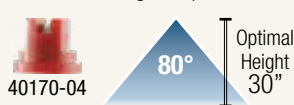

ER 110° Flanged Tips

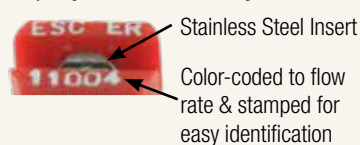

Tip Size	-005	-0067	-01	-015	-02	-025	-03	-04	-05	-06	-08
80° ER Tip	ER80-005	ER80-007	ER80-01	ER80-015	ER80-02	ER80-025	ER80-03	ER80-04	ER80-05	ER80-06	ER80-08
Part #	40170-005	40170-007	40170-01	40170-015	40170-02	40170-025	40170-03	40170-04	40170-05	40170-06	40170-08
110° ER Tip	-	-	ER110-01	ER110-015	ER110-02	ER110-025	ER110-03	ER110-04	ER110-05	ER110-06	ER110-08
Part #	-	-	40169-01	40169-015	40169-02	40169-025	40169-03	40169-04	40169-05	40169-06	40169-08

For flow rate charts, spray quality, and more information on flanged spray tips, reference the 80° and 110° spray nozzle charts.

COMBO-JET® Caps, Adapters & Strainers

Wilger manufactures a variety of caps that are used for metering flow rates (through hose barb, push-in tube, or streamer caps) or used as accessories for other spraying or plumbing functions.

Plug Caps



Caps unused Combo-Jet nozzle body outlets

40272-B5

Plug Cap	
Assembled Plug	Cap Only
40272-B5	40272-05

Threaded Outlet Adapters



Threaded adapter caps can be used for any application that would require a threaded fitting.

Threaded Outlet Caps		
Thread Size	FKM O-ring Assy	Cap Only
1/8" NPT-F	40277-B5	40277-05
1/4" NPT-F	40273-B5	40273-05
45° 1/4" NPT-F	40274-B5	40274-05

Hose Barb Caps



Hose barb caps can be used as manifold plumbing parts or for metering flow.

Hose Barb Caps		
Barb Size	FKM O-ring Assy	Cap Only
1/8"	40420-B5	40420-05
1/4"	40422-B5	40422-05
3/8"	40424-B5	40424-05
1/2"	40426-B5	40426-05

To use cap for metering, order CAP ONLY, with o-ring and 40285-## metering orifice.

Push-in-Tube Caps



Quick connect tube caps seal on the outside diameter of a tube, and used as manifold plumbing parts or for metering flow.

Quick Connect/Push-in-tube Caps		
Tube Size (O.D.)	FKM O-ring Assy	Cap Only
1/4"	40435-B5	40435-05
5/16"	40437-B5	40437-05
3/8"	40436-B5	40436-05

To use cap for metering, order CAP ONLY, with o-ring and 40285-## metering orifice.

2-Hole & 3-Hole Streamer Caps



2-hole streamer caps are used to stream liquid fertilizer for 10" coverage

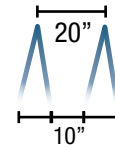

3-hole streamer caps are used to stream liquid fertilizer for ~6.67" coverage

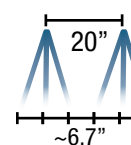

Drilled Fertilizer Streamer Caps [CAP ONLY]			
Cap Size	Flow Range	2-Hole Cap	3-Hole Cap
Small	0.05 - 0.4 us gpm	40432-047	40433-047
Medium	0.2 - 1.0 us gpm	40432-086	40433-087
Large	0.5 - 3.0 us gpm	40432-104	40433-104

COMBO-JET Cap O-rings



40260-00
FKM

13mm x 3mm o-ring for COMBO-JET® Caps & Spray Tips



40260-V0
viton



40261-00

Adapter for non-metering caps
Seal adapter is used to keep o-ring in place if metering orifice is NOT used

~B5' Assembly Breakdown - For non-metering apps

For applications that do not require liquid metering orifices (e.g. plumbing manifolds), the -B5 is an assembly that includes an o-ring (#40260-00), seal adapter (#40261-00 in lieu of orifice), and cap.

New Hose Drop & Extension Caps

Hose Drop Caps are used to feed or spray down below a canopy to minimize crop contact.

Outlet	Length	Part #
Combo-Jet to Combo-Jet	2"	40210-00
	5"	40211-00
Combo-Jet Cap to 1/4" NPT-M	16"	22026-00
	24"	22036-00
	36"	22038-00
	48"	22048-00



Other styles of Hose Drop Assemblies using threaded inlets are also available. Find them in the DRY BOOMS section of the catalog.

COMBO-JET Snap-in Strainers

Combo-jet strainers snap into the metering orifice or seal adapter for a 'one-piece'-handling cap



40250-00



40251-00



40249-00



40248-00

Strainers			
Mesh Size	Slotted Strainer	Stainless Mesh	Color
100 mesh	-	#40251-00	Green
50 mesh	40249-00	#40250-00	Blue
25 mesh	40248-00	-	Yellow
16 mesh	40247-00	-	Gray

Ordering [Drilled] Streamer Caps

For drilled streamer cap assembly, order:

1. Metering Orifice (40285-## series)*
2. Streamer cap (2 or 3 hole, sized to flow range)
3. O-ring seal (40260-00 or 40260-V0)
4. [Optional] Slotted Strainer

*For selecting metering orifices to fit your application, use Tip Wizard, consult flow charts, or use other tools available at www.wilger.net

New 3-hole streamers (FS3) now available



3-hole fertilizer streamer (FS3) nozzle improves stream consistency at higher pressures for improved application.

Visit the COMBO-JET Fertilizer charts for part numbers

COMBO-JET® Nozzle Bodies

The COMBO-JET® Advantage



Hinged Clamp for easy installation

Compact body sits directly under the boom. Perfect for tight boom frames & heavy PWM solenoids

Nozzle Bodies can swap right/left orientation to avoid sprayer boom frame



KWIKSTOP™ raised inlet option available to reduce nozzle run-on

Debris-cleaning 3/8" inlet slots for less residue buildup

Bodies can be equipped with any combination of control modules, including AIR-OFF, PWM solenoid, Manual ON/OFF or spring-based diaphragm check valves

Nozzle Bodies available in Combo-Jet or Square Lug styles (Teejet/Hypro/etc) with 1, 2 or 3 nozzle outlets

Single Outlet COMBO-JET® Nozzle Bodies

Robust and cost effective nozzle bodies for sprayers and used on wet boom liquid fertilizer kits.

Boom Pipe	Outlets	Style	Part#
3/4" (0.84" OD)	1 CJ	Check Valve	40611-00
1" (1.315" OD)	1 CJ	Check Valve	40621-00
		Manual On/Off	40621-MS
		No Module	40621-NM



40621-00 Single



40611-P15 Single Outlet w/ 15PSI check valve (red) and hose barb cap

Commonly used in liquid fertilizer metering manifolds mounted on plumbed pipe

KWIKSTOP™ stops Run-on

KWIKSTOP™ passively purges air trapped in the sprayer boom.



Nozzles are fed from the top of the pipe

Less air means Less Nozzle Run-on & Drips

KWIKSTOP™ is a trademark, owned by BRANDT INDUSTRIES LTD.

Dual Outlet COMBO-JET® Swivel Bodies

Robust and cost effective nozzle bodies for sprayers to switch up to two nozzles by simply rotating the outlet. Safer and easier than handling contaminated nozzles.

Boom Pipe	Outlets	Style	Part#
3/4" (0.84" OD)	2 CJ	Check Valve	40612-00
1" (1.315" OD)	2 CJ	Check Valve	40622-00
		Manual On/Off	40622-MS
		No Module	40622-NM



40622-00 Dual Swivel Combo-Jet



40622-NM Dual Swivel w/o Check Valve

Commonly used to cost effectively retrofit a sprayer to a PWM spray system

High/Low PSI Check Valves

Replace assembly part # ending '-00' to order 4PSI or 15PSI check valves



4 PSI '-P4' [BLUE] 10 PSI '-00' [Standard] 15 PSI '-P15' [RED]

Triple Outlet COMBO-JET® Swivel Bodies

Robust and cost effective nozzle bodies for sprayers to switch up to three nozzles by simply rotating the outlet. Safer and easier than handling contaminated nozzles.

Boom Pipe	Outlets	Style	Part#
3/4" (0.84" OD)	3 CJ	Check Valve	40613-00
1" (1.315" OD)	3 CJ	Check Valve	40623-00
		Manual On/Off	40623-MS
		No Module	40623-NM



40623-00 Triple Swivel Combo-Jet



40623-NM Triple Swivel w/o Check Valve

Commonly used to cost effectively retrofit a sprayer to a PWM spray system

1" KWIKSTOP™ Nozzle Bodies

Nozzle bodies with raised inlets to passively purge air trapped at the top of a sprayer boom pipe, reducing nozzle run-on & improving boom shut-off response times.

Boom Pipe	Outlets	Style	Part#
1" (1.315" OD)	1 CJ	Check Valve	40631-00
	2 CJ	Check Valve	40632-00
	3 CJ	Check Valve	40633-00



40631-00 Single w/ KWIKSTOP Raised Inlet



Smooth Clamp Bodies

Swivel bodies have been switched to a standard bolt-mount hinge clamp.

Contact Wilger for a cross-reference chart for the smooth clamp part numbers and their bolt-mount replacement.

Nozzle Body Specifications

Operating Pressure	10"-100PSI
Single Outlet Flow Rate	2.1 us gpm @ 5PSI pressure drop
	3.1 us gpm @ 10PSI pressure drop
Dual Swivel Flow Rate	1.7 us gpm @ 5PSI pressure drop
	2.7 us gpm @ 10PSI pressure drop
Triple Swivel Flow Rate	1.6 us gpm @ 5PSI pressure drop
	2.6 us gpm @ 10PSI pressure drop
O-ring Seals	FKM (viton avail.)
Materials	SS (screws)
	Polypropylene (body) Celcon (lower swivel)

Square Lug Swivel Nozzle Bodies & Accessories

Single Outlet Square Lug Nozzle Bodies

Robust and cost effective nozzle bodies for sprayers and used on wet boom liquid fertilizer kits.

Boom Pipe	Outlets	Style	Part#
3/4" (0.84" OD)	1 Square Lug	Check Valve	40651-00
		No Check	40140-00
1" (1.315" OD)	1 Square Lug	Check Valve	40661-00
		Manual On/Off	40661-MS
		No Module	40661-NM
		No Check	40141-00



KWIKSTOP™ stops Run-on

KWIKSTOP™ passively purges air trapped in the sprayer boom.

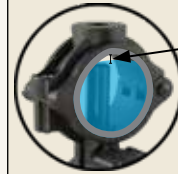

Nozzles are fed from the top of the pipe

Less air means Less Nozzle Run-on & Drips

KWIKSTOP™ is a trademark, owned by BRANDT INDUSTRIES LTD.

Dual Outlet Square Lug Nozzle Bodies

Robust and cost effective nozzle bodies for sprayers to switch up to two nozzles by simply rotating the outlet. Safer and easier than handling contaminated nozzles.

Boom Pipe	Outlets	Style	Part#
3/4" (0.84" OD)	2 Square Lug	Check Valve	40652-00
		No Check	40140-00
1" (1.315" OD)	2 Square Lug	Check Valve	40662-00
		Manual On/Off	40662-MS
		No Module	40662-NM
		No Check	40141-00



High/Low PSI Check Valves

Replace assembly part # ending '-00' to order 4PSI or 15PSI check valves



Triple Outlet Square Lug Nozzle Bodies

Robust and cost effective nozzle bodies for sprayers to switch up to three nozzles by simply rotating the outlet. Safer and easier than handling contaminated nozzles.

Boom Pipe	Outlets	Style	Part#
3/4" (0.84" OD)	3 Square Lug	Check Valve	40653-00
		No Check	40140-00
1" (1.315" OD)	3 Square Lug	Check Valve	40663-00
		Manual On/Off	40663-MS
		No Module	40663-NM
		No Check	40141-00



Nozzle Body Specifications

Operating Pressure	10"-100PSI
Single Outlet Flow Rate	2.1 us gpm @ 5PSI pressure drop
	3.1 us gpm @ 10PSI pressure drop
Dual Swivel Flow Rate	1.7 us gpm @ 5PSI pressure drop
	2.7 us gpm @ 10PSI pressure drop
Triple Swivel Flow Rate	1.6 us gpm @ 5PSI pressure drop
	2.6 us gpm @ 10PSI pressure drop
O-ring Seals	FKM (viton avail.)
Materials	SS (screws)
	Polypropylene (body) Celcon (lower swivel)

1" KWIKSTOP™ Square Lug Nozzle Bodies

Nozzle bodies with raised inlets to passively purge air trapped at the top of a sprayer boom pipe, reducing nozzle run-on & improving boom shut-off response times.

Boom Pipe	Outlets	Style	Part#
1" (1.315" OD)	1 Square Lug	KWIKSTOP	40671-00
	2 Square Lug	KWIKSTOP	40672-00
	3 Square Lug	KWIKSTOP	40673-00



Swivel Body Replacement Parts - For ALL TYPES Swivel Bodies

- 40166-04 O-ring Repair Kit, CJ Nozzle Bodies, FKM (6 Bodies)
- 40166-05 O-ring Repair Kit, CJ Nozzle Bodies, VITON® (6 Bodies)
- 40193-02 SCREW, Hi-Lo, #10 x 3/4" SS [for Hinged Swivel Bodies]
- 40155-23 Molded Diaphragm, FKM (replaces 40155-07 + 20455-04)
- 20455-07 O-ring, 3/8" inlet seal, #110, FKM, Duro 70
- 20455-04 O-ring, Pressure Pad, Replacement (pairs with 40155-07)
- 40155-07 Diaphragm Rubber Seal, EPDM (use w/ #20455-04)
- 40155-12 Diaphragm Rubber Seal, VITON® (use w/ #20455-04)

3/8" Nozzle body inlet o-ring



20455-07

Hi-Lo screw for Swivel Bodies

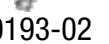

40193-02

CJ Nozzle Body Repair Kits* (up to 6 bodies)

- | | |
|-----------------------------------|-----------------|
| BUNA-N Kit incl. | viton Kit incl. |
| 6x Pressure Pad O-rings #20455-04 | #20455-V4 |
| 24x Inner-body O-rings #40155-09 | #40155-13 |
| 6x Diaphragms #40155-07 | #40155-12 |

*Kits will include either a pair of #20455-04 & #40155-07, or #40155-23. Both serve the same function.

NEW



40155-23
Requires pressure pad o-ring to be removed



20455-04 40155-07*
*Also requires 20455-04 pressure pad o-ring

PRODUCT UPGRADE: Diaphragms

A molded, single-piece diaphragm is replacing the two-piece diaphragm rubber + pressure pad o-ring.



For replacing old-style parts, ENSURE pressure pad o-ring is removed from check valve module, and the new diaphragm groove fits where the pressure-pad o-ring was. [Bottom View]

Module Nut #41100-02

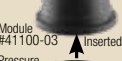

Module #41100-03
Pressure Pad O-ring #20455-04
Diaphragm #40155-07

Replaced by Single-Piece Molded Diaphragm



*May be black, red or brown (viton)

Square Lug Nozzle Body Accessories - Only for Square Lug Nozzle Body Outlets (Teejet, Hypro, etc)

Plug Cap

40180-05
Caps Square Lug nozzle outlets

3/8" Slot

40159-05
For 3/8" wide flanged spray tips

Threaded Cap

40164-00
45° 1/4" NPT-F thread

Flanged Strainers

40150-00 40158-00 40151-00
Stainless Steel Strainers for Square-Lug Caps & Nozzles

Cap Gaskets

40160-00 [FKM]
40160-VO [viton]
Gaskets are required to seal all Square Lug Caps

COMBO-RATE® Stacking Nozzle Bodies

The COMBO-RATE® Advantage



Debris-cleaning inlet slots for less residue buildup

Hinged Clamp for easy install

Two-Way Nozzle Bodies can reverse left/right for universal mounting

U-clip fittings can be easily retrofitted to use any future COMBO-RATE products

High flow bodies with low pressure-drop

Bodies can be equipped with any combination of control modules, including AIR-OFF, PWM solenoid, Manual ON/OFF or spring-based diaphragm check valves

Ability to spray with multiple nozzles simultaneously OR reserve integrated nozzle body for fertilizer top-dressing

COMBO-RATE® Side-fed Saddles

Robust side-fed saddles mount with a inlet hole on the side of a sprayer boom, with a female combo-clip port for CR bodies

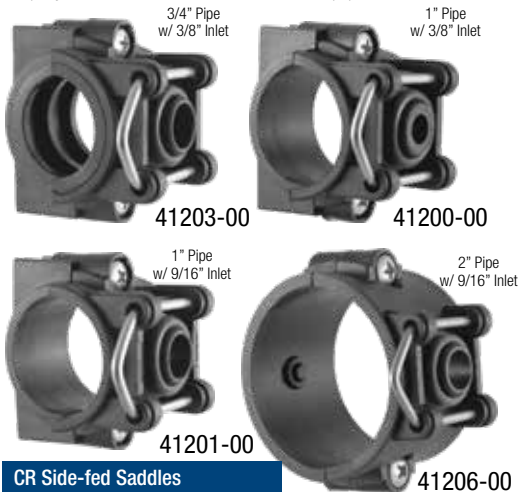

CR Side-fed Saddles		
Boom Size	Inlet Size	Part#
3/4" Pipe (1.05" OD)	3/8" inlet	41203-00
1" Pipe (1.315" OD)	3/8" inlet	41200-00
1" Pipe (1.315" OD)	9/16" inlet	41201-00
2" Pipe (2.375" OD)	9/16" inlet	41206-00

COMBO-RATE® II Top or Bottom-fed Saddles

Combo-Rate II saddles can be fed with an bottom inlet or flipped and fed from a hole in the top of a boom pipe to passively purge air trapped in a sprayer boom.

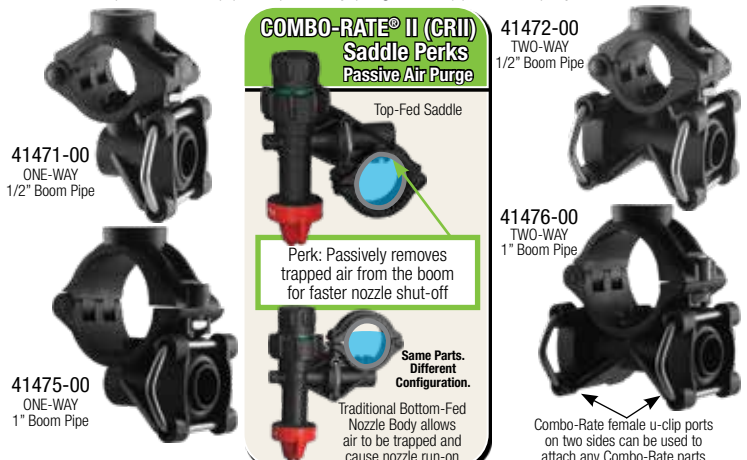

CR II One-Way Stacking Saddles

Boom Size	Inlet Size	Part#
1/2" Pipe (0.84" OD)	3/8" inlet	41471-00
1" Pipe (1.315" OD)	3/8" inlet	41475-00
	9/16" inlet	41477-00
	21/32" inlet	41479-00

CR II Two-Way Stacking Saddles

Boom Size	Inlet Size	Part#
1/2" Pipe (0.84" OD)	3/8" inlet	41472-00
1" Pipe (1.315" OD)	3/8" inlet	41476-00
	9/16" inlet	41478-00

COMBO-RATE® II Integrated Nozzle Bodies

One-Way Stacking Integrated COMBO-RATE® II Nozzle Bodies

One-way stacking COMBO-RATE nozzle bodies stack to the left with one open u-clip port. Typically using a manual on/off module, these bodies can be used to spray separately than turrets/bodies or simultaneously from multiple nozzles. Multiple nozzle spraying can be an effective way to improve coverage in high volume applications to make a more meaningful mix of droplets.



KWIKSTOP®
Raised Inlet Available



41433-00



41453-00

KWIKSTOP®
Raised Inlets
Naturally aspirate the boom, reducing nozzle run-on

HOW THEY WORK: Manual ON/OFF Check Valves

Since Combo-Rate nozzle bodies stack, a manual way to turn off flow to certain outlets is required.

When the knob is **OPEN**, it acts as a standard 10 PSI check valve.

When the knob is **CLOSED**, it turns off flow to that nozzle outlet **ONLY**. It does not effect other stacked nozzle bodies.



Nozzle Body Specifications

Operating Pressure	10"-100PSI *(80PSI for air-off)
3/8" Inlet Single Outlet Flow Rate	2.1 us gpm @ 5PSI pressure drop 3.1 us gpm @ 10PSI pressure drop
9/16" Inlet Single Outlet Flow Rate	2.2 us gpm @ 5PSI pressure drop 3.5 us gpm @ 10PSI pressure drop
21/32" Inlet High Flow Single Outlet Flow Rate	3.0 us gpm @ 5PSI pressure drop 4.0 us gpm @ 10PSI pressure drop
O-ring Seals	FKM (viton avail.)
Materials	SS (screws) Glass-Reinforced Polypropylene (body)

* 10PSI minimum with 10PSI check valve

Boom Size	Sch40 Pipe Outside Diameter	Inlet Size	Stacking Direction	Nozzle Bodies with 5/16" Bolt Mount Upper Clamp			
				Module Description & Part#			
				Dia. Check Valve	Manual ON/OFF	Air-Off Operated ²	PWM (w/o Nut)**
1/2"	0.84"	3/8" Inlet	One-Way	41411-00	41413-00	41415-00	41417-00
3/4"	1.05"	3/8" Inlet	One-Way	41421-00	41423-00	41425-00	41427-00
28mm	28mm	3/8" Inlet	One-Way	41481-00	41483-00	41485-00	41487-00
1"	1.315"	3/8" Inlet	One-Way	41431-00	41433-00	41435-00	41437-00
		9/16" Inlet	One-Way	41441-00	41443-00	41445-00	41447-00
1" KWIKSTOP	1.315"	3/8" Inlet	One-Way	41451-00	41453-00	41455-00	41457-00

Two-Way Stacking Integrated COMBO-RATE® II Nozzle Bodies

Two-way stacking COMBO-RATE nozzle bodies stack to both directions, with two open u-clip ports. Typically using a manual on/off module, these bodies can be used to spray separately than turrets/bodies or simultaneously from multiple nozzles. Multiple nozzle spraying can be an effective way to improve coverage in high volume applications to make a more meaningful mix of droplets.



KWIKSTOP®
Raised Inlet Available

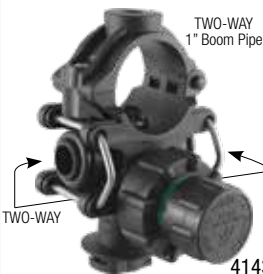

41434-00



41438-00



41414-00

High Flow Nozzle Bodies

For very high flow requirements, use the 21/32" inlet size nozzle bodies.



21/32" inlet hole

Boom Size	Sch40 Pipe Outside Diameter	Inlet Size	Stacking Direction	Nozzle Bodies with 5/16" Bolt Mount Upper Clamp			
				Module Description & Part#			
				Dia. Check Valve	Manual ON/OFF	Air-Off Operated ²	PWM (w/o Nut)**
1/2"	0.84"	3/8" Inlet	Two-Way	41412-00	41414-00	41416-00	41418-00
3/4"	1.05"	3/8" Inlet	Two-Way	41422-00	41424-00	41426-00	41428-00
28mm	28mm	3/8" Inlet	Two-Way	41482-00	41484-00	41486-00	41488-00
		3/8" Inlet	Two-Way	41432-00	41434-00	41436-00	41438-00
1"	1.315"	3/8" Inlet	Two-Way	41442-00	41444-00	41446-00	41448-00
		9/16" Inlet	Two-Way	41462-00	41464-00	41466-00	41468-00
1" High Flow	1.315"	21/32" Inlet	Two-Way	41462-00	41464-00	41466-00	41468-00
1" KWIKSTOP	1.315"	3/8" Inlet	Two-Way	41452-00	41454-00	41456-00	41458-00

Stacked Outlet Specification

Operating Pressure	10"-100PSI *(80PSI for air-off)
3/8" Inlet Two Outlets Used Flow Rate	3.2 us gpm @ 5PSI pressure drop 5.0 us gpm @ 10PSI pressure drop
9/16" Inlet Two Outlets Used Flow Rate	3.6 us gpm @ 5PSI pressure drop 6.2 us gpm @ 10PSI pressure drop
21/32" Inlet High Flow Two Outlets Used Flow Rate	4.6 us gpm @ 5PSI pressure drop 9.0 us gpm @ 10PSI pressure drop
O-ring Seals	FKM (viton avail.)
Materials	SS (screws) Glass-Reinforced Polypropylene (body)

* 10PSI minimum with 10PSI check valve

Combo-Rate Body, Turret Replacement & Auxiliary Parts

- 40200-02 O-ring, CR Inter-body, #206, FKM
- 20455-07 O-ring, 3/8" Nozzle Body Inlet Stem, #110, FKM
- 40200-02 O-ring, 9/16" Nozzle Body Inlet Stem, #206, FKM
- 41361-02 O-ring, 21/32" Nozzle Body Inlet Stem, #115, FKM
- 20460-04 U-clip, 304SS
- 41331-03 Screw, HiLo, SS, CR11 Body Hinge Clamp Screw (for 2016+ newer)
- 41285-00 Adapter, CR Plug (Covers unused Combo-Rate port)
- 41286-00 Plug, Inner CR2 port plug (fits inside side port of CR11 bodies)
- 41502-04 CR Turret Outlet Arm, Combo-Jet Outlet
- 41502-10 CR Turret Outlet Arm, Square Lug Outlet
- 41502-13 CR Turret Outlet Arm, Double-Down Combo-Jet Outlet
- 41502-05 CR Turret Outlet Arm, Plug
- 40155-23 Diaphragm, Molded, FKM (Replaces #40155-07 + 20455-04)
- 41100-15 CR11 Nozzle Body O-ring Repair Kit, FKM (6 Bodies)
- 41100-16 CR11 Nozzle Body O-ring Repair Kit, VITON® (6 Bodies)
- 41502-11 CR Turret Repair Kit, FKM (2 Bodies)
- 41502-12 CR Turret Repair Kit, VITON® (2 Bodies)
- 41593-00 Plug, CR Clamp to plug 21/32" inlet hole on 1" pipe

* Requires #20455-07 O-Ring



41592-00
Bolt-Mount Clamp for any 1.315" OD. pipe or tube



41331-03



41285-00



41502-05*



41502-04*



41502-10*



41502-13*



20460-04



40200-02 Inter-body O-ring



20455-07 Turret Arm O-ring

COMBO-RATE®
Turret Repair Kits
(For up to 2 turrets):
#41502-11 or -12

COMBO-RATE® II
Body Repair Kits*
(For up to 6 bodies):
#41100-15 or -16

*Repair kits may include a pair(s) of #40155-07 and #20455-04, or a single #40155-23. Both serve the same purpose. Ensure to remove the pressure pad o-ring if #40155-23 is being used.



41593-00
21/32" Inlet Plug Clamp



40155-23 Replaces Molded Diaphragm + pad o-ring



40155-07 Diaphragm

Standard Kit includes viton Kit incl.
10x Turret Outlet O-rings #20455-07 #40155-13
4x Turret Core O-rings #41502-06 #41502-V6
2x Diaphragm #40155-07 #40155-12
2x Combo-Jet Outlet Arm #41502-04 #41502-04
2x Turret Plugs #41502-05 #41502-05
2x Turret Lock Clips #41502-09 #41502-09

Standard Kit includes viton Kit incl.
6x Pressure Pad O-rings #20455-04 #20455-V4
6x Inter-body O-rings #40200-02 #40200-V2
6x Diaphragms #40155-07 #40155-12

COMBO-RATE® Stacking Thru & End Bodies

COMBO-RATE® Thru Bodies

Thru bodies stack onto any existing combo-clip female port and adds an additional combo-clip female port for further expansion.

Manual **ON/OFF** Check Valve Air-Off Operated Check Valve



COMBO-RATE Thru Body [Connects to any Combo-Rate female ports]			
Dia. Check Valve	Manual ON/OFF	Air-Off Operated ²	PWM (w/o nut)**
41100-00	41110-00	41125-00	41135-00

COMBO-RATE® End Bodies

End bodies stack onto any existing combo-clip female port to add a nozzle body that can be equipped for any spraying needs.

Manual **ON/OFF** Check Valve PWM w/o nut**
(For PWM Solenoids, or equivalent control)



COMBO-RATE End Body [Connects to any Combo-Rate female ports]			
Dia. Check Valve	Manual ON/OFF	Air-Off Operated ²	PWM (w/o nut)**
41101-00	41111-00	41126-00	41136-00

CR Swivel End Bodies

End bodies that can be adjusted (via interior screw) in 15° increments for fence-row & crop adapted spraying applications. Attaches to any combo-clip female port.



COMBO-RATE End Body [Connects to any Combo-Rate female ports]			
Dia. Check Valve	Manual ON/OFF	Air-Off Operated ²	PWM (w/o nut)**
41102-00	41112-00	41127-00	41137-00

Combo-Rate Stacking Body Specification

Operating Pressure 10"-100PSI ² (80PSI for air-off)	O-ring Seals FKM (viton avail.)	Materials Glass-reinforced Polypropylene	Flow Rate 2.1 us gpm (end & thru), 1.6 us gpm (swivel body)
--	------------------------------------	---	--

COMBO-RATE® Turrets

The COMBO-RATE® Turret Advantage

Common U-clip connections for all Combo-Rate parts

Each turret arm is o-ring sealed to minimize dust & debris entry

Module threads are compatible with most PWM spray systems

Front Turret

Side Turret

Top Turret



Three styles of turret for best fit & function

Bodies can be equipped with any combination of control modules, including **AIR-OFF**, PWM solenoid, Manual **ON/OFF** or spring-based diaphragm check valves

Multiple options for Single CJ, Square Lug, or Double-Down outlets

Double-Down Turrets allow for dual nozzle spraying for better overage in high volume & fungicide applications

COMBO-RATE turrets provide you options to configure a desired turret configuration, allowing it to be a universal turret for any brand of sprayer or nozzles.

COMBO-RATE® Stacking Component Examples

COMBO-RATE® Side-Fed Saddles



Side-Fed saddle with a thru and end body

COMBO-RATE® II (CRII) Top/Bottom-Fed Saddles



Top-Fed Saddle
Traditional Bottom-Fed Saddle

PERK Passively removes air from the boom
Same parts, but different configuration to solve sprayer issues.

COMBO-RATE® II Bottom-Fed Nozzle Body



NEW
CR Turrets
Solenoid not included

COMBO-RATE® Stacking Components



Thru Bodies
End Bodies
Swivel End Bodies (For Fence-row nozzles)

PERK Adjustable Swivel in 15° increments
NEW

COMBO-RATE® Turrets - cont'd

Sprayers have different nozzle requirements, due to spacing, boom frame design & interference, so Wilger has three styles of turrets that can be used to fit any situation.

COMBO-RATE Front Turrets

Front turrets stack onto any COMBO-RATE nozzle body, mounting on the common u-clip port. Turrets are available in a variety of outlet and module styles, which are mounted onto the 'front' face of the turret.

Number of Outlets	Description & Part #			
	Dia. Check Valve	Manual ON/OFF	Air-Off Operated	PWM (w/o nut)*
3 CJ Outlet	41503-00	41513-00	41543-00	41533-00
4 CJ Outlet	41504-00	41514-00	41544-00	41534-00
5 CJ Outlet	41505-00	41515-00	41545-00	41535-00
3 CJ Outlet + 2 SQ Lug Outlet	41505-32*	41515-32*	41545-32*	41535-32*
Double-Down + 4 CJ Outlet	41506-00	41516-00	41546-00	41536-00



41515-00 Manual ON/OFF Check Valve Module
41535-00 Open module thread must have PWM solenoid or other control module to function

HOW THEY WORK: Manual ON/OFF Valves

Since Combo-Rate nozzle bodies stack, a manual way to turn off flow to certain outlets is required.



When the knob is **OPEN**, it acts as a standard 10 PSI check valve.

When the knob is **CLOSED**, it turns off flow to that nozzle outlet **ONLY**. It does not effect other stacked nozzle bodies.

Module Installation & Re-installation

During installation, ensure knob is in **OPEN** orientation. Otherwise the binding nut cannot seal the check valve module. Ensure the orientation tabs (green) are seated properly.

COMBO-RATE Side Turrets - Reversible

Side turrets stack onto any COMBO-RATE nozzle body, mounting on the common u-clip port. Turrets are available in a variety of outlet and module styles, which are mounted onto the side of the turret with a reversible module stem.

Number of Outlets	Description & Part #			
	Dia. Check Valve	Manual ON/OFF	Air-Off Operated	PWM (w/o nut)*
3 CJ Outlet	41603-00	41613-00	41643-00	41633-00
4 CJ Outlet	41604-00	41614-00	41644-00	41634-00
5 CJ Outlet	41605-00	41615-00	41645-00	41635-00
3 CJ Outlet + 2 SQ Lug Outlet	41605-32	41615-32	41645-32	41635-32
Double-Down + 3 CJ Outlet	41606-00	41616-00	41646-00	41636-00



Left/Right Reversible Module Stems
41615-00 Manual ON/OFF Module
41602-07 Kit for Teejet PWM Solenoids
41602-09 Kit for Hypro/Arag PWM Solenoids

Reversing Orientation

Switch a side turret module stem from left to right in seconds. No extra parts required.



41635-00 PWM Side Turret** (w/o nut)
Right Module Orientation with module removed
Left Module Orientation
180° Reversible Module Stems

41602-07 Side-Turret Core Replacement kit for Teejet Threaded PWM Solenoid
41602-09 Side-Turret Core Replacement kit for Arag /Hypro Threaded PWM Solenoid

NEW COMBO-RATE Top Turrets

Top turrets stack onto any COMBO-RATE nozzle body, mounting on the common u-clip port. Turrets are available in a variety of outlet and module styles, which are mounted onto the top of the turret. Ideal for use with bulky PWM solenoids in tight booms.

Number of Outlets	Description & Part #			
	Dia. Check Valve	Manual ON/OFF	Air-Off Operated	PWM (w/o nut)*
3 CJ Outlet	41803-00	41813-00	41843-00	41833-00
4 CJ Outlet	41804-00	41814-00	41844-00	41834-00
5 CJ Outlet	41805-00	41815-00	41845-00	41835-00
3 CJ Outlet + 2 SQ Lug Outlet	41805-32	41815-32	41845-32	41835-32
Double-Down + 4 CJ Outlet	41806-00	41816-00	41846-00	41836-00



Module points upwards to keep large solenoids (e.g. Hawkeye II) out of the way of other boom parts.
Open module thread must have PWM solenoid or other control module to function
PWM READY
41836-00 No module nut (for PWM Solenoid) with double-down outlet

NEW Double-Down Turrets

Double nozzles from a single turret outlet. Great for double-down PWM spraying.

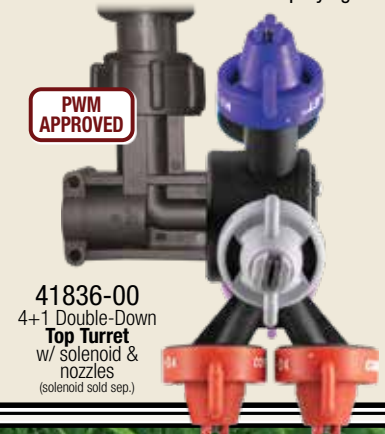

PWM APPROVED
41836-00 4+1 Double-Down Top Turret w/ solenoid & nozzles (solenoid sold sep.)

Increasing Coverage with Crop-Adapted Spraying

Different crops require different kinds of spray coverage for best efficacy, so changing how spray is deposited can often provide beneficial results in both coverage and application efficacy. It starts with adapting how the crop is being targeted, ensuring maximizing spray deposition on the target area, and minimizing spray on less-ideal or wasted areas.

For example, using two spray tips **straight down** can provide better penetration through thick canopies, allowing for better interior canopy coverage; while two angled spray patterns **forward & backward** can lead to spray coverage at the top canopy foliage or on both front/back of a cereal head.

Why use two nozzles straight down, and not a multi-angle spray tip?

Further distance to target can mean less canopy penetration with angled

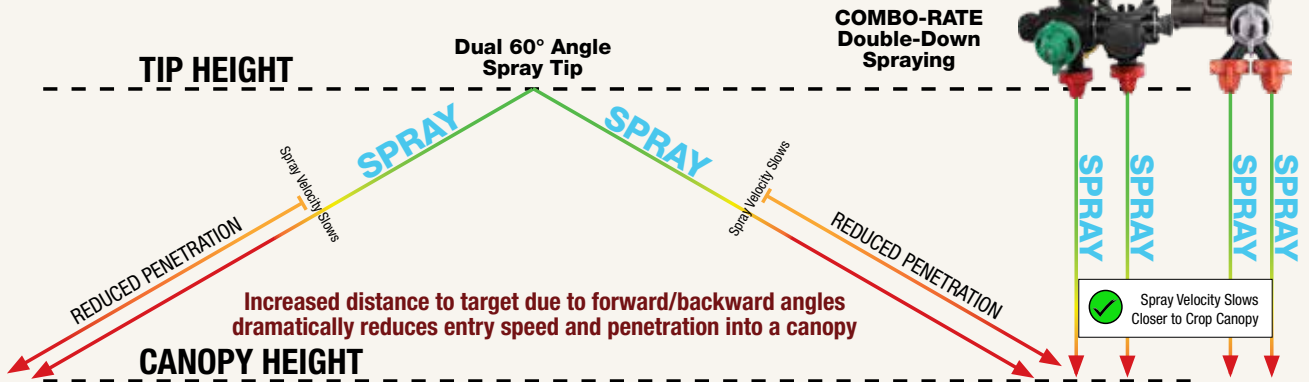

COMBO-RATE gives you better penetration and coverage for a more consistent application into thick canopy crops.

Examples of Tough to Penetrate Crop Canopies

Options for Double-Down Spraying

Stacked bodies



Double-Down Adapters



Double-Down Turrets

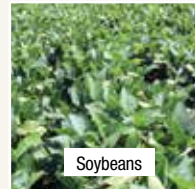
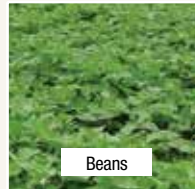

Picking Nozzles for Double-Down Spraying?

Applicators often already have nozzles to be used in pairs for double down spraying. E.g. 5 + 10 gal/acre nozzles could be used for 15 gal/acre. Visit the dual tip spraying guide in the catalog for more info.

What about spraying vertical targets that don't have a dense canopy?

Angled spray for vertical growing targets (e.g. cereal heads) can provide superior coverage

Spraying a vertical target is different than spraying into a canopy. Spraying forward/backward with a nozzles produces spray that can travel horizontal, making it more effective to cover vertical targets at suitable boom heights.

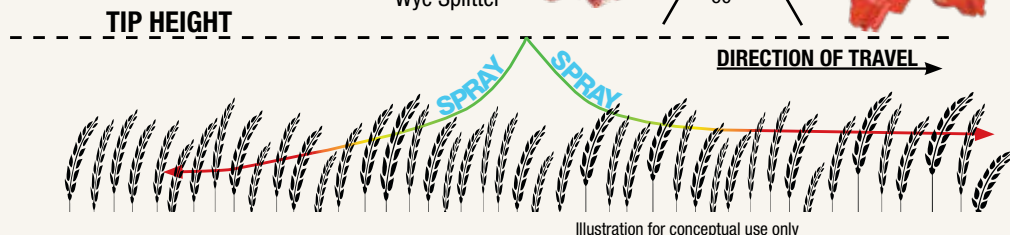
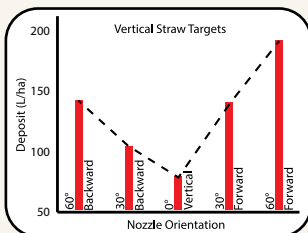

Dry Boom Nozzle Bodies & Accessories

Compact Nozzle Bodies

Compact Bodies have many uses, as inline check valves on planting equipment, estate sprayers, dry boom nozzle bodies, or other situations that would require a compact check valve with a Combo-Jet cap outlet.

Outlet Adapter



40498-00
3/8" NPT-F
inlet

Inlet	Part #
1/4"	40497-00
3/8"	40498-00

Adapts a threaded port to a Combo-Jet outlet

1/4" Push-in Tube Bodies



40502-NM
*solenoid or control module must be used on -NM assemblies



40502-00
1/4" Quick Connect inlet

Inlet (O.D.)	10PSI Check	4PSI Check	No Module
1/4"	40502-00	40502-P4	40502-NM

Adapts a 1/4" O.D. tube inlet to a Combo-Jet outlet

Threaded Inlet Bodies



40501-P4

4PSI Check Valve [Blue]

1/4" bolt mount



40501-00
1/4" NPT Female inlet

Thread	10PSI Check	4PSI Check	No Module
1/8" NPT-F	40500-00	40500-P4	40500-NM
1/4" NPT-F	40501-00	40501-P4	40501-NM

Adapts a female thread inlet to a Combo-Jet outlet

Mounting

A 5/8"x1/4" slotted profile is used to mount compact bodies with 1/4" bolts

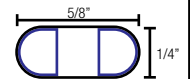

[Rear view] #40501-00 w/ bracket

5/8" Square-Mount Dry Boom Swivel Nozzle Bodies with 3/8" NPT-F feed

Square-Mount nozzle bodies attach to a boom frame with 5/8" square mounts, and are fed by a 3/8" NPT-F inlet.

Add a 3/8" NPT hose shank adapter 40311-00



40352-00

COMBO-JET Square-Mount Bodies



40352-00



40353-00



40354-00

Outlets	Part #
Single CJ	40352-00
Dual CJ	40353-00
Triple CJ	40354-00

Square Lug Square-Mount Bodies



Square Lug Outlets (Teejet/Hypro/etc.) with dust shield



40152-00



40153-00

Outlets	Part #
Dual Sq. L	40152-00
Triple Sq. L	40153-00

3/8" NPT-M Hose Shank Adapters



40311-00



40312-00



40313-00

Fitting	One-Way	Two-Way	Three-Way
3/8" HB x 3/8" NPT-M	40301-00	40302-00	-
1/2" HB x 3/8" NPT-M	40306-00	40307-00	-
3/4" HB x 3/8" NPT-M	40311-00	40312-00	40313-00

Combo-Jet Outlet Swivel Turret Adapters

Turret Adapters intended for slow movement applications without risk of being struck



40471-00



40470-00



40473-00



40472-00

Swivel Outlets	Dual Turret	Triple Turret
Combo-Jet Outlet	40470-00	40471-00

Swivel Outlets	Dual Turret	Triple Turret
Square Lug Outlet	40472-00	40473-00

High Mount Dry Boom Nozzle Bodies with Hose Shank Feed

High Mount Flange

Flange Mount bodies mount right above the nozzle cap, with a round hole with notches cut to fix nozzle orientation



40461-00



3/8" HB

1/4" NPT-M

40464-00

Inlet(s)	One-Way	Two-Way
3/8" Hose Barb	40460-00	40461-00
1/2" Hose Barb	40462-00	40463-00
3/8" HB x 1/4" NPT-M	-	40464-00

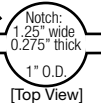

Notch: .25" wide 0.275" thick
1" O.D.
[Top View]

5/8" Square Mount Nozzle Bodies

5/8" Square Mount nozzle bodies attach to a clamp with a 5/8" square mount



40451-00



40450-00

Inlet(s)	One-Way	Two-Way
3/8" Hose Barb	40450-00	40451-00
1/2" Hose Barb	40452-00	40453-00
3/8" HB x 1/4" NPT-M	-	40454-00

Sq Mt w/o check

Square Mount Compact Bodies without check valves



40406-00

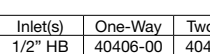

40407-00

Inlet(s)	One-Way	Two-Way
1/2" HB	40406-00	40407-00

5/8" Square Mount Stainless Steel Clamps

Wilger manufactures a series of 5/8" square mount clamps that are used with compatible nozzle bodies. Refer to the CLAMPS pages to find the full listing of available stainless steel clamps



Dry Boom Nozzle Bodies & Accessories - cont'd

Rotating Adjustable Swivel Bodies & Hose Drop Assemblies

Hose Drop Adapters

Nylon hose drops are used to feed bodies to spray down below a canopy to minimize crop contact

Hose Drop Adapters

Inlet	Outlet	Length	Part #
1/4" NPT-M	1/4" NPT-M	16"	22021-00
		24"	22031-00
		36"	22037-00
		48"	22047-00
1/4" NPT-F	1/4" NPT-F	16"	22025-00
		24"	22035-00

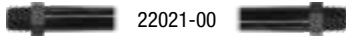

22021-00

Adjustable Swivel Bodies [360° Lockable Rotation Front/Back]

Swivel Bodies can be rotated front to back 360° use for Crop Adapted Spraying or other targeting



Hose Drop & Extension Caps

Outlet	Length	Part #
Combo-Jet to Combo-Jet	2"	40210-00
Combo-Jet to Combo-Jet	5"	40211-00
Combo-Jet Cap to 1/4" NPT-M	16"	22026-00
	24"	22036-00
	36"	22038-00
1/4" NPT-M	48"	22048-00

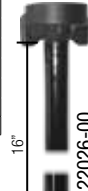

22026-00



40210-00
2" Combo-Jet Cap Extension

2.25"



5.25"

40211-00
5" Combo-Jet Cap Extension

Inlet Size	Outlet(s)	Control Modules		
		Without Dia.	Dia. Check	Manual On/Off
1/4"	Single	40225-00	40231-00	40237-00
	Double	40226-00	40232-00	40238-00
1/4" NPT-F	Single	40227-00	40233-00	40239-00
	Double	40228-00	40234-00	40240-00
1/4" NPT-M w/ 1/4" NPT-F	Single	40229-00	40235-00	40241-00
	Double	40230-00	40236-00	40242-00
3/8" HB w/ 5/8" Sq. Mount	Single	40243-00	40244-00	40245-00

Crop Adapted Spraying

Using adjusted nozzle angles, swath and direction to better adapt to specific crop targets to maximize efficacy or minimize risk

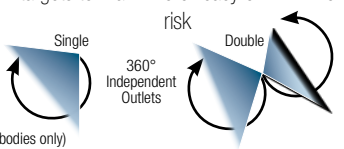

40237-03 ... Diaphragm Manual Shut-off Assembly, Replacement (for adjustable swivel bodies only)

Low-Mount Compact Bodies - Contact Factory for availability. (Non-stocked item)

11/16" Thread Mount Low Mount Bodies

A low mounting compact body that attaches to a sprayer boom frame with an 11/16" threaded nut.



40366-00

40367-00

40155-21

Inlet Size	One-Way [Left]	One-Way [Right]	Two-Way
3/8" HB	40360-00	40361-00	40362-00
1/2" HB	40365-00	40366-00	40367-00
3/4" HB	40370-00	40371-00	40372-00

40155-21 Module Retainer, Replacement
40199-00 Lock Nut, 11/16" Thread

5/8" Square Mount Low Mount Bodies

A low mounting compact body that attaches to a sprayer boom frame with an common 5/8" square mounting port.



40385-00

40382-00

40155-21

Inlet Size	One-Way [Left]	One-Way [Right]	Two-Way	Three-Way
3/8" HB	40380-00	40381-00	40382-00	40383-00
1/2" HB	40385-00	40386-00	40387-00	40388-00
3/4" HB	40390-00	40391-00	40392-00	N/A

40155-21 Module Retainer, Replacement

COMBO-RATE Boomless Sprayer Manifold Assemblies

Boomless sprayers are used to spray areas not accessible by traditional boomed sprayers, such as ditches, roadways, pastures, and commercial/industrial areas.

COMBO-RATE boomless sprayers can be configured in hundreds of ways depending on mounting, size, and flow requirement.

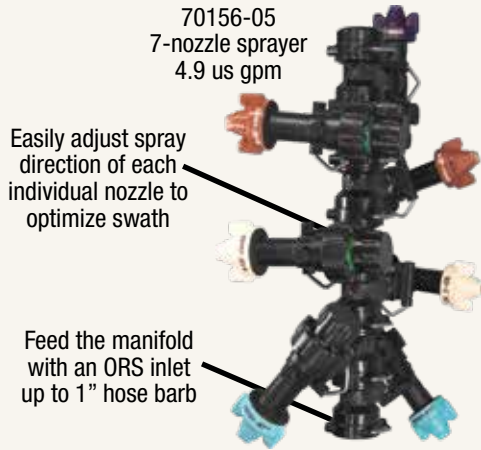

Example Assembly	Flow Rate (us gal/min)	Part#
3-Nozzle Boomless Spraying Manifold	1.3 us gal/min	70154-01
	2.6 us gal/min	70154-03
	5.8 us gal/min	70154-06
5-Nozzle Boomless Spraying Manifold	2.3 us gal/min	70155-02
	2.9 us gal/min	70155-03
	5.8 us gal/min	70155-06
	11.5 us gal/min	70155-12
7-Nozzle Boomless Spraying Manifold	3.9 us gal/min	70156-04
	4.9 us gal/min	70156-05
	9.6 us gal/min	70156-10
	19.5 us gal/min	70156-20

Adjustable swath distance charts online



Easy-to-follow charts are online to help you figure out how to get the swath distance for your application needs.

Find them at www.WILGER.NET

Stainless Steel Clamps for Sprayer & Liquid Fertilizer Appl.

5/8" Square Mount Clamps

5/8" Square Mount clamps attach a nozzle body with 5/8" square mount to a tube or pipe



Mount Size	Standard 5/8" Square Mount Clamp (SS)		Adjustable High-Reach 5/8" Square Mount Clamp (SS)
	for Round Tube	for Square Tube	for either Round Tube or Square Tube
1/2"	40320-SS	N/A	3/4" Tube Extra High Reach
3/4"	40321-SS	40325-SS	40343-SS
1"	40322-SS	40326-SS	3/4" to 1-1/4"
1-1/4"	N/A	40327-SS	40341-SS
1-1/2"	N/A	40328-SS	1-1/2" to 2"
2"	N/A	40330-SS	40342-SS

Two-Hole Bolt-Mount Clamps for Sq. Tube

Two-Hole Clamps for Flow Indicator, Manifold, & Nozzle Body Mounting



Three-Hole Bolt-Mount Clamps for Sq. Tube

Three-Hole Clamps for Sprayer Boom Tube, Nozzle Body & Utility Mounting
Boom tube clamps are sold in halves, so two are required for proper use.

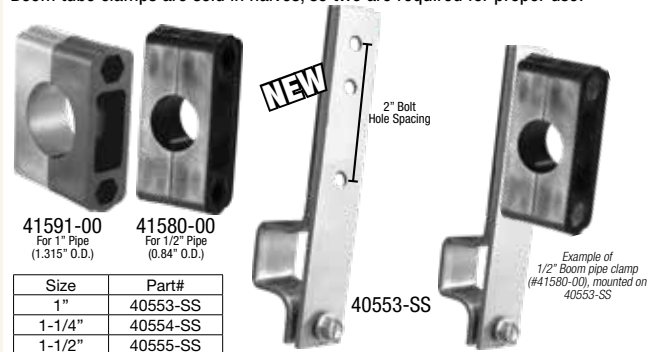

3/4" Square Mount Clamps for Nozzle Bodies



Nozzle Body Accessories & Replacement Parts

Combo-Rate Control Modules & Nuts

Wilger manufactures a few styles of control modules that can be swapped between any Combo-Rate or Combo-Jet nozzle bodies



Check Valve Type	Extra Information	10 PSI (Standard)	4 PSI (Blue Knob)	15 PSI (Red Knob)
Diaphragm	Drip check, use 41100-02 nut	41100-03	41100-12	41100-11
Manual ON/OFF	In "Off" position, closes check valve (no flow)	41110-01	41110-07	41110-08
Air-OFF	When air is applied, closes check valve (no flow)	41125-01	-	-

* Recommended to apply 20PSI more than spray pressure for ideal operation & quick shut-off

Diaphragm Seals

Rubber Diaphragms are used in ALL control modules to seal the flow within the check valve



40155-23 (FKM)

All-in-One Diaphragm, used in parts made after 2019

The bottom of the control modules have a groove for a pressure pad o-ring or all-in-one diaphragm



Two-piece diaphragm & pressure pad o-ring

Diaphragm	Pressure pad O-Ring
40155-07 (EDPM)	20455-04 (Buna-N)
40155-12 (viton)	20455-V4 (viton)

Either rubber diaphragm can be typically used, but ensure to replace diaphragm in proper orientation and remove pressure pad o-ring if 40155-23 diaphragm is used.

O-ring Seals

O-ring seals are commonly used on many component parts. FKM material is standard, viton is available.

O-ring	Description/Where Used	FKM#	VITON #
13mm x 3mm	COMBO-JET spray tips	40260-00	40260-V0
#009	CR Top-turret faceplate	41802-04	40802-V4
#015	ORS Metering orifices	40225-04	40225-05
#106	9/16" Nozzle body inlet	51204-04	51204-V4
#108	Module pressure pads	20455-04	20455-V4
#110	3/8" Nozzle body inlet	20455-07	20455-V7
#115	21/32" Nozzle body inlet	41361-02	41361-V2
#116	1/2" QN100 connections	25120-02	25120-V2
#118	ORS Strainer cartridges	-	20576-V4
#119	EFM Sensor housing seal	20580-12	20580-13
#121	CR Turret core seals	41502-06	41502-V6
#203	5/16" Push-In Tube O-ring	20457-03	20457-V3
#206	CR Stacked body side seal	40200-02	40200-V2
#212	O-ring Seal (ORS) fittings	20460-03	20460-15
#214	Boom end flush valve core	-	25175-08
#219	QN100 O-ring seal	25160-02	25160-V2

Inter-body Strainers

Inter-body strainers are used in-between Combo-Rate nozzle bodies to catch burrs or debris during the break-in period of new sprayers, or to further protect PWM solenoids



Strainer Mesh	Part#
50 Mesh	41150-00
80 Mesh	41152-00
100 Mesh	41151-00

Air Tees & Reducers

Tees and Reducers that can be used to couple tube for air or liquid supply

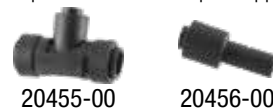

Fitting Type	Description	Part#
Tee	3/8" x 3/8" x 1/4" O.D.	20455-00
	5/16" x 5/16" x 1/4" O.D.	20457-00
Reducer	3/8" x 1/4" O.D.	20456-00

Estate Sprayer Manifolds, Accessories & Adapters

Estate Sprayer Manifold Assemblies

Wilger manifold assemblies are pre-built manifolds based on common requirements. COMBO-RATE components can be used to expand or change any manifold.

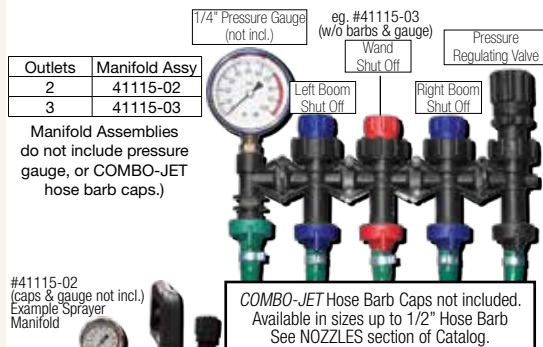

Outlets	Manifold Assy
2	41115-02
3	41115-03

Manifold Assemblies do not include pressure gauge, or COMBO-JET hose barb caps.)

#41115-02 (caps & gauge not incl.) Example Sprayer Manifold

COMBO-JET Hose Barb Caps not included. Available in sizes up to 1/2" Hose Barb See NOZZLES section of Catalog.



Manifolds can also be built with O-Ring Seal (ORS) Fittings

Connection	Pressure Regulating Valve	Manual On/Off Check Valve	1/4" NPT-F for Pressure Gauge
Thru Body	41130-00	41110-00	-
End Body	41131-00	41111-00	-
Combo-Clip Male	-	-	41251-00
End Body	-	-	-
Combo-Clip Female	-	-	-

Combo-Clip (CC) Adapters & 3/4" Sq. Mount Clamps

Combo-Clip connections are compatible with all Combo-Rate Fittings and Nozzle Bodies

Connection	Outlet	Part #
Combo-Clip Male	Plug	41285-00
	1/4" NPT-F	41275-00
	3/8" NPT-F	41276-00
Combo-Clip Female	1/4" NPT-F	41251-00
	1/4" NPT-M	41252-00
	3/8" NPT-M	41253-00
	90° CC-M	41250-00
Combo-Clip Female w/ 3/4" Sq Mount	1/4" NPT-F	41255-00
	3/8" NPT-F	41256-00



Clamps for 3/4" Square-Mount Adapters

Square Tube Size	3/4" Sq. Mount Nozzle Body Clamps
1"	41261-SS
1-1/4"	41262-SS
1-1/2"	41263-SS
2"	41264-SS

Combo-Clip Adapters can be used to convert a traditional dry boom sprayer to use cutting edge COMBO-RATE turrets & fittings

41256-00 w/ 3/4" Sq. Mount Clamp

Regulating & Manual On/Off Manifold Valves

Pressure Regulating Valves
Open or close to regulate how much flow is bypassed back to tank to regulate pressure. Lock washer is used to hold position

When in 'ON' position, acts as a 10PSI drip check. When in 'OFF' position, it turns off flow to the outlet

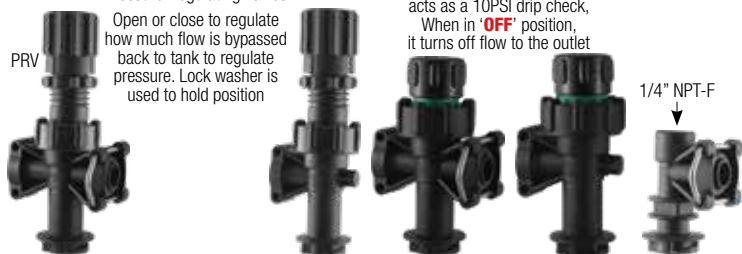

Ensure to visit the NOZZLES section of the catalog for the full listing of COMBO-JET Caps

1/2" & 1" Stainless Steel Tube For Quick-Nut & Quick-Flange Fittings

Wilger Stainless Steel Tubing is engineered for high performing modern sprayers. The high flow sprayer boom tube shares outside dimensions of commonly-used sch40 pipe, but with dramatically reduced weight. Custom tube lengths, spacing and inlet holes are available by order.



Larger Inside Diameter
Inside diameter is larger to accommodate higher flow rates

Rolled End for Cost-Effective Manufacturing
Tube ends are rolled instead of threaded to minimize downtime, and thread leaking/failure

For Recirculating Booms
Compatible boom fittings & tubing for building recirculating booms

1" Stainless Steel Tubing
Shares 1" sch40 pipe outside diameter (1.315" OD.) with larger 1.25" inside diameter

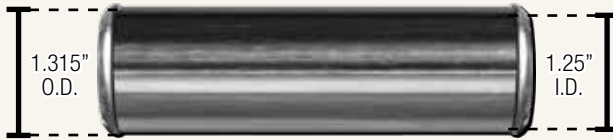

Lighter 1" Boom = Less Fuel
weighs 66% of aluminum
weighs 23% of sch40 pipe
Lighter than hose

1/2" Stainless Steel Tubing
Shares 1/2" sch40 pipe outside diameter (0.84" OD.) with larger 0.788" inside diameter



Lighter 1/2" Boom = Less Fuel
weighs 80% of aluminum
weighs 28% of sch40 pipe
Lighter than hose

Sprayer Tube Shipping Consideration - Length
Depending on requirement for sprayer tube length, shipping costs are generally less expensive for tubes that are less than 9' (108") in length.

Pre-punched Outlet Spacing
Sprayer tubes are commonly pre-punched to 20" nozzle spacing, but also available in pre-punched to 10", 15", 30" or custom spacing as required.

Picking the Correct Style of Tube End & Length

Different sprayer boom configurations require different combinations of lengths of tube. To simplify the boom configuration & planning process, consider starting with tubes with the least amount of extra material on the ends. This will reduce dead-ends that may trap chemical residue. With the minimal tube length in mind (# of holes on tube x hole spacing), then consider different tube-end configurations. Some fittings shorten the tube lengths required (as they include the last nozzle), reducing the # of holes required.

Standard Tube Ends (2")

Tubes that have 2" of tube after the last nozzle body are commonly used with QN100 or QF100 plumbing parts.

of holes x outlet spacing (inches) + 4" of ends (2" + 2")

Super Compact Nozzle Body Ends (18")

The CR BEFV & QF100 w/ CR clamp integrates the last nozzle for a super compact boom end. The tube should be 2" shorter than the intended nozzle spacing to maintain consistent nozzle spacing.

NOTE: For **each** CR BEFV/Integrated Elbow, tube will be 1 inlet hole "short".

Center-fed Section Ends (8" or 8.25")

Tubes that are center-fed with Tees require a pair of longer tube sides to maintain proper 20" spacing with a 4" (QN100) or 3.5" (QF100) wide tee.

10" Ends for Tube to Tube SST

For situations that require two smaller tubes to be joined tube to tube, the 10" ends maintain 20" spacing between the last nozzle bodies

Select a Type of Plumbing Parts

NEW Quick-Flange (QF100) Fittings

A series of flanged adapters that convert either a rolled-end tube (like SST) or other 1.315" OD tube/pipe to a common 1" flange and tool-free clamp system.

Available for 1" boom sizes.

Quick Nut (QN100 & QN50) Fittings

A series of quick couplers that use the rolled end to connect to a variety of sweep sprayer fittings to maximize flow capacity and boom hygiene.

Available in both 1" & 1/2" boom sizes.

Quick-Flange Fittings & Fluid Supply System

The Quick-Flange Advantage

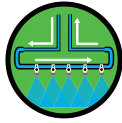

Perfect Recirc. Booms



Stronger Compact Fittings

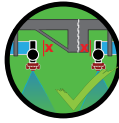

Compact Boom End Options



No Threads or Sealant Required



Cutting out Boom Contamination

Retrofitting & Flange Compatibility

Fittings available for complementing any sort of sprayer boom & more.

CAN BE OUTFITTED FOR:

1" sch40 Pipe (1.315" OD)

Any 1" Flanged Fittings

Wilger Stainless Tubing

Case Thin Wall Stainless

Compatible with other 1" Flange Fittings

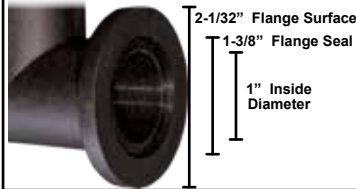

Compact & Robust Sweep Fittings

Sweep fittings reduce turbulence & pressure loss, producing a sprayer that is capable of higher flow rates with less restriction.



Recirculation Made Easy

Many options for any recirculating boom

Super Compact COMBO-RATE BOOM END FLUSH VALVE W/ RECIRCULATION



Quick-Flange Adapters for Different Sprayer Tubing Types

Adapting Quick-Flange Fittings to any 1" PIPE, 1" SST, or Case® TWS Boom Tube

QF100 Fittings can be seamlessly retrofitted or adapted to any 1" Pipe, QN SST, or TWS Booms to a 1" Flange Fitting.

Case® Thin-Wall Stainless (TWS) to Quick-Flange



Three-piece flange adapter snaps over the boom pipe and tightens with a binding nut, sealing with a TWS to QF100 Seal.

27312-00 27343-00
3-piece flange adapter end QF100 x 1-1/4" HB, 90°

Case® is a registered trademarks of CNH Industrial America LLC.

Wilger Stainless Steel Tube (SST) to Quick-Flange



Three-piece flange adapter snaps over the boom pipe and tightens with a binding nut, sealing with a SST to QF100 Seal.

27312-00 27343-00
3-piece flange adapter end QF100 x 1-1/4" HB, 90°

Through-Pipe to Quick-Flange (For CR BEFV only)



27382-00 27360-00
QF100 through-pipe adapter kit CR BEFV for with flange sleeve removed

Two half-clamps mount on a boom tube, securing to the tube-end adapter. The result is a flanged tube end with up to 1" of excess tube material sticking out of the adapter. This excess tube slides into a CR BEFV, providing tube length flexibility.

Cut-Pipe to Quick-Flange



27381-00 27343-00
QF100 cut-pipe adapter kit QF100 x 1-1/4" HB, 90°

Two half-clamps mount on a boom tube, securing to the cut pipe-end adapter. The result is a common-flange end.

Compatible with any Quick-Flange or common-flange fittings.

Not shown: An additional compact 2-piece pipe end adapter is also available for Case Thin-wall stainless tube, and Wilger SST. It is not intended for robust, mobile applications, but remains an option for adapting tube to a flange end.

Building a SST Sprayer Boom for Quick-Flange (QF100)

When planning to build a sprayer boom with Wilger's Stainless Steel Tube, follow these steps to break down the process and engineer the best performing sprayer boom possible.

STEP 1 Determine tube lengths & spacing required for each section. Simply count the number of outlets on each required boom tube between each fold, accounting for separated sections (if required).

STEP 2 Split up nozzle sections based on boom type, or to minimize boom tube length (e.g. 11 nozzles max).

For Recirculating (R) Sprayer Booms: Anticipate keeping sections made with as few boom tubes as possible, as plumbing fittings will only be on the either end of the tube (aside from any tube-to-tube joints on the same section)

For Standard (S) Sprayer Booms: Anticipate splitting sections in half, allowing for a center-fed sweep tee, providing optimal pressure to each nozzle in each sprayer section.

STEP 3 Determine whether any boom end nozzle bodies (like Combo-Rate Boom End Flush Valve nozzle body) are being used, as they may require different lengths (as they encompass the last outlet on a sprayer boom)

STEP 4 Determine the tube end spacing depending on the fittings used.
CR BEFV requires 18" tube end. Tube Joint requires 10" tube end. Regular fittings requires 2" end.

For example, a 5-section recirculation sprayer, with 72 outlets (on 20" spacing) using Combo-Rate End Flush Valve Bodies

	SECTION 1	SECTION 2		SECTION 3	SECTION 4		SECTION 5
STEP 1 Section sizing	11 nozzles	20 nozzles		10 nozzles	20 nozzles		11 nozzles
STEP 2 Tube Lengths	11 hole	10 hole + 10 hole joined		10 hole	10 hole + 10 hole joined		11 hole
STEP 3 Specialty Boom End Considerations	11 hole -2 (CR BEFV) 9 hole tube	10 hole -1 (CR BEFV) 9 hole tube + joint	10 hole -1 (CR BEFV) 9 hole tube + joint	10 hole -2 (CR BEFV) 8 hole tube	10 hole -1 (CR BEFV) 9 hole tube + joint	10 hole -1 (CR BEFV) 9 hole tube + joint	11 hole -2 (CR BEFV) 9 hole tube
STEP 4 Tube/End Lengths to Order	9 hole tube with 18" End (CR BEFV) & 18" End (CR BEFV)	9 hole tube with 18" End (CR BEFV) & 10" End (joint)	9 hole tube with 10" End (joint) & 18" End (CR BEFV)	8 hole tube with 18" End (CR BEFV) & 18" End (CR BEFV)	9 hole tube with 18" End (CR BEFV) & 10" End (joint)	9 hole tube with 10" End (joint) & 18" End (CR BEFV)	9 hole tube with 18" End (CR BEFV) & 18" End (CR BEFV)

QF100 fittings for a Traditional Sprayer Boom

Conventionally plumbed Center-Fed Section using Case Thin-Walled Stainless (TWS) Boom Tube, with last nozzle body integrated directly into the flush valve



QF100 fittings for a Recirculating Sprayer Boom

Recirculating sprayer boom plumbed using Wilger Stainless Steel Tube (SST), with last nozzle body integrated directly into the flush valve and recirc hose barbs.

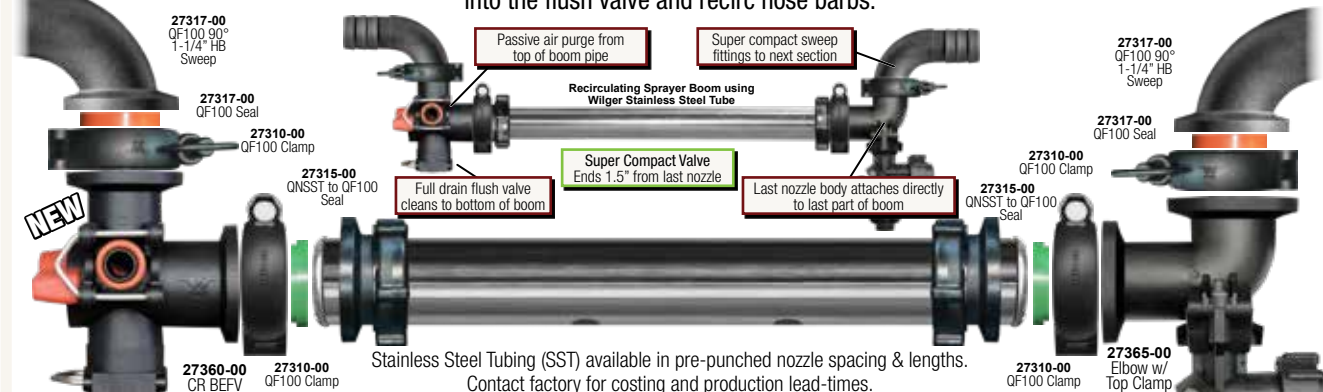

Quick-Flange Tube-End Adapters, Seals & Kits

QF100 Tube-End & Pipe-End Adapters, Seals & Kits

Gasket seals mate different tube & QF100 fittings together. Ensure correct seals are identified for each connection.

3pc End Adapter

27312-00



Wilger SST

Case TWS

Max Pressure
150psi/10BAR

2 halves secure over pipe, affixed with binding nut

Seals Used

Wilger SST uses flared taper gasket



27315-00

2pc End Adapter

27313-00

for non-mobile applications, requiring low pressure



Case TWS

2 halves secure over SST

Max Pressure
100psi/7BAR

Case TWS uses stepped or skirted gasket



OR
27316-00 [std]
27316-02 [skirt]

Adapters & Kits

Boom End/Tube Type	Adapter/Kit
Wilger SST rolled end OR Case TWS flared end	[3pc] 27312-00
	[2pc] 27313-00
	Cut pipe end kit [9pc] 27381-00
Through pipe end kit [9pc]	27382-00
NPT-F	1/2" NPT-F 27357-00
Threaded Pipe Adapters	3/4" NPT-F 27358-00 1" NPT-F 27359-00

QF100 Gasket Seals

Seal Type	Part#
SST Tube x Flange	27315-00
TWS Tube x Flange	27316-00
TWS Tube x Flange, skirted	27316-02
Flange x Flange	27317-00
Wilger SST to SST	27318-00
Case TWS to TWS	27319-00

Tube to Flange End Seals

MATERIAL: FKM

Gasket seal against a formed tube end profile

Tube to Flange Seals	Part#
SST Tube x Flange	27315-00
TWS Tube x Flange	27316-00
TWS Tube x Flange - skirted -	27316-02



27315-00

TWS Tube x Flange



27316-00 Standard Gasket

27316-02 Skirted Gasket

Cut Pipe End Adapter Kit

27381-00 For any 1.315" OD pipe/tube
Drill two 3/8" holes, 1.1-1.25" from pipe end



1.1-1.25"

Kit seals holes and pipe, converting to flange end

Seals Used

Uses QF100 Standard Gasket
27317-00



Flange to Flange Fitting Seal

MATERIAL: FKM

Gasket seals against common 1" flange fitting ends

Flange Seal	Part#
Flange x Flange	27317-00



27317-00

Flange x Flange

Through Pipe Adapter Kit

27382-00 For any 1.315" OD pipe/tube
Drill two 3/8" holes, 2.25-3" from end

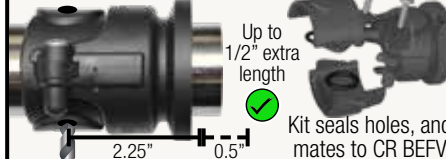

2.25"

Up to 1/2" extra length

Kit seals holes, and mates to CR BEFV

Most Secure

Use with CR BEFV



Tube End to Tube End Seals

MATERIAL: FKM

Gasket seals between two butt ends of tube

Tube to Tube Seals	Part#
Wilger SST to SST	27318-00
Case TWS to TWS	27319-00



27318-00

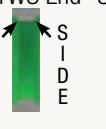

27319-00

Threaded Pipe Adapter

For male national pipe threaded (NPT) pipes



Available in 1/2", 3/4" & 1" NPT-F sizes

27357-00

27358-00

27359-00

Threaded

Uses QF100 Standard Gasket
27317-00



Quick-Flange Clamps

Compact & robust clamps for easy installation & adjustment with hinging bolt. Compatible with common 1" flange fittings.

Poly Clamp	Part#
Butterfly Nut & Bolt	27310-00
Nut & Bolt	27311-00

Butterfly Nut Flange Clamp
27310-00

Nut & Bolt Flange Clamp
27311-00



Polypropylene Clamp & Stainless Hardware



QF100 Adapters & Caps

QF100 Plugs, and other adapters for auxiliary connections to QF100 fittings

Size/Style	Description	Part#
Plug Cap	QF100 Plug Cap	27353-00
Female Thread Adapter	QF100 x 1/2" NPT-F	27357-00
	QF100 x 3/4" NPT-F	27358-00
	QF100 x 1" NPT-F	27359-00
Male Thread Adapter	QF100 x QN100-M Thread	27351-00
	QF100 x TWS-M Thread	27352-00



27357-00



27358-00



27359-00



27351-00



27352-00

E.g. QF100 to QN100 Flush Valve



Quick-Flange Fittings & Parts

QF100 Elbows & Hose Barb Fittings

Compact & high flow sweep fittings for less pressure loss & higher flow capability for a better performing sprayer boom.

Size/Style	Description	Part#
Flange	Elbow, 90°, Compact	27324-00
x Flange	Elbow, 45°, Compact	27326-00
1"	QF100 x 1" HB, Straight	27331-00
Hose Barb	QF100 x 1" HB, 45° Sweep	27332-00
x QF100	QF100 x 1" HB, 90° Sweep	27333-00
1-1/4"	QF100 x 1-1/4" HB, Straight	27341-00
Hose Barb	QF100 x 1-1/4" HB, 45° Sweep	27342-00
x QF100	QF100 x 1-1/4" HB, 90° Sweep	27343-00



High Flow Sweep Fittings

QF100 Tee & Sweep Tee Fittings

Sweep Tees

Compact & high flow sweep fittings for less pressure loss & higher flow capability for a better performing sprayer boom.

Sweep Tee Fittings	Part#
QF100 x QF100 x QF100	27371-00
QF100 x QF100 x 1-1/4" HB	27372-00
QF100 x QF100 x 1" HB	27373-00

Regular Tees

Compact tees for flat bottom drainage.

Sweep Tee Fittings	Part#
QF100 x QF100 x QF100	27321-00
QF100 x QF100 x 1-1/4" HB	27322-00
QF100 x QF100 x 1" HB	27323-00



High Flow Sweep Fittings

Sweep Tees

NEW

COMBO-RATE Boom End Flush Valve (CR BEFV)

The Better Boom End Nozzle Body & Valve

A boom end flush valve with two Combo-Rate ports for attaching a fence-row nozzle body, turret, or any COMBO-RATE fittings.

Valve version	Part#
Recirc Model w/ plugs	27361-00
Non-Recirc model w/ plugs	27362-00
Non-recirc w/ butterfly nut	27362-VN

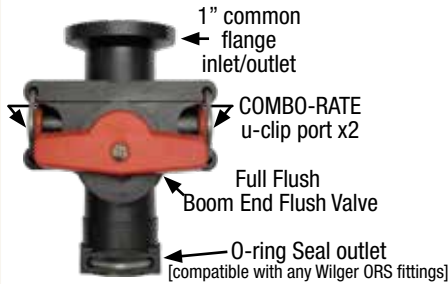

Designed for Recirculating Booms

Designed to incorporate an inline flange fitting for easy recirc configuration.

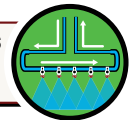

Passive Air Purge

Nozzle pulls air directly from the top of boom pipe reducing nozzle run-on



Super Compact Boom Ends

The last nozzle body, flush valve and flange outlet combined in one piece

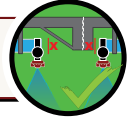

Remove Dead Spots in the boom

Boom ends directly with last nozzle body and flush valve to ensure boom hygiene

NEW for 2023

QF100 Flange Elbow with Nozzle Body Upper Clamp

A compact flanged elbow with built-in nozzle body clamp

Nozzle Body Inlet Size	Module Orientation	
	Outward Facing	Inward Facing
3/8" Inlet	27365-00	27366-00
21/32" High Flow Inlet	27367-00	27368-00



Designed for Recirculating Booms

Designed to incorporate an inline flange fitting for easy recirc configuration.

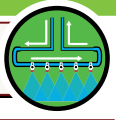

Remove Dead Spots in the boom

Boom ends directly with last nozzle body to reduce risk of residue build-up



Super Compact Boom Ends

The last nozzle body, flush valve and flange outlet combined in one piece



1" Quick-Nut (QN100) Boom Fittings & Stainless Steel Tube

The Quick-Nut Fitting & SST Advantage

Lighter Booms - Wilger SST
weighs 66% of aluminum
weighs 23% of sch40 pipe
Lighter than hose

Lower Cost
compared to other pipe plumbed
sprayer booms

Recirculating Booms
Compatible boom fittings & tubing
for building recirculating booms

Less Chemical Residue
compared to hose-plumbed sprayers

High Flow Boom Pipe
Maintains 1" pipe outside diameter,
but inside diameter flows like 1-1/4"

Sweep Fittings
reduce turbulence
& increase boom flow capacity

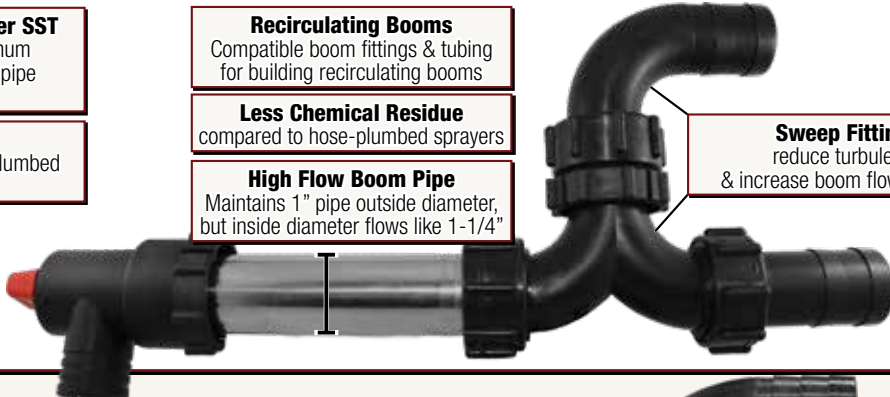

QN100 Fittings for a Conventional Sprayer Boom

Contact Wilger for Custom Boom Tube & Hole Configurations for your sprayer boom.

[CANADA] Wilger Industries Ltd.
1 (833) 242-4121
info@wilger.net

[USA] Wilger Inc.
1 (877) 968-7695
WilgerESC@WilgerESC.com

Example of a few possible configurations of
1" Quick-Nut (QN100) Sprayer Fittings



Stainless Tube (SST)
to Boom End Flush Valve (BEFV)

Sweep Tee to Stainless Tube (SST)

Sweep Tee to Hose Barb

25175-LV0 25160-02 25171-00

41591-00

25170-00 25160-02

25160-02

25160-03 25160-01

Boom End
Flush Valve
-Long Handle-

Male QN
Connection

Boom
Clamp

Female QN
Connection

QN100
Flared End

25172-00
Sweep Tee

Nut

Straight Barb

QN100 Connectors & Components

Easy to use boom end fittings and connectors to adapt 1" Wilger Stainless Steel Tubing (SST) to QN100 fittings.

For QN100
Connections

Component	Description	Part#
SS Tube End Adapters	Female Thread End, 2pc	25170-00
Adapters	Male Thread End, split ring	25171-00
Quick Nut	Nut with QN100-F Thread	25160-03
Plug	QN100 x Plug Cap	25163-01
O-ring for QN100 Connections	#219 O-ring, FKM	25160-02
Connections	#219 O-ring, viton	25160-v2
Threaded Adapters	QN100 x 3/4" NPT-F Thread	25164-01
	1" NPT-F x QN100M Bushing	25137-00
Boom Tube Clamps	Half Clamp, for 1" SST (1.31" OD)	41591-00
	Half Clamp, for 1-1/4" Tube	41590-00
	BEFV Cover Cap	25175-10
Replacement Parts	BEFV Seal Repair Kit (2 valves)	25175-11
	BEFV Handle, Long	25175-13
	BEFV Handle, Short	25175-03

25160-02

25160-03

25164-01

25163-01

25137-00



25175-10

25175-03
Compact Handle

25175-13
Long Handle

25137-00

QN100 Tee Fittings

Compact & lightweight sweep tees for any sprayer boom configuration.



Description	Part#
QN100 Flare x QN100M x QN100M	25172-00
1" Hose x QN100M x QN100M	25168-00
1-1/4" Hose x QN100M x QN100M	25169-00

25169-00

25172-00

QN100 Hose Barb Fittings

Compact & lightweight hose barb fittings for any sprayer boom configuration.



Size/Style	Description	Part#
1" HB	QN100 x 1" HB, Straight	25166-01
x QN100	QN100 x 1" HB, 90° Sweep	25167-01
1-1/4"	QN100 x 1-1/4" HB, Straight	25160-01
Hose Barb	QN100 x 1-1/4" HB, 45° Sweep	25162-01
x QN100	QN100 x 1-1/4" HB, 90° Sweep	25161-01

25160-01

25161-01

QN100 & 1" NPT Boom End Flush Valves

Compact valve for full-drain flushing of booms.

Type	Description	Part#
QN100	QN100 BEFV, Short Handle	25175-V0
	QN100 BEFV, Long Handle	25175-LV0
1" NPT-F	1" NPT BEFV, Short Handle	25176-V0
	1" NPT BEFV, Long Handle	25176-LV0



25175-LV0

25176-V0

1/2" Quick-Nut (QN50) Boom Fittings & Stainless Steel Tube

QN50 Fittings for a Conventional Sprayer Boom

Contact Wilger for Custom Boom Tube & Hole Configurations for your sprayer boom.

[CANADA] Wilger Industries Ltd.
1 (833) 242-4121
info@wilger.net

[USA] Wilger Inc.
1 (877) 968-7695
WilgerESC@WilgerESC.com

Example of a few possible configurations of 1/2" Quick-Nut (QN50) Sprayer Fittings

Stainless Tube (SST) to Plug Cap

Sweep Tee to Stainless Tube (SST)

Sweep Tee to Hose Barb

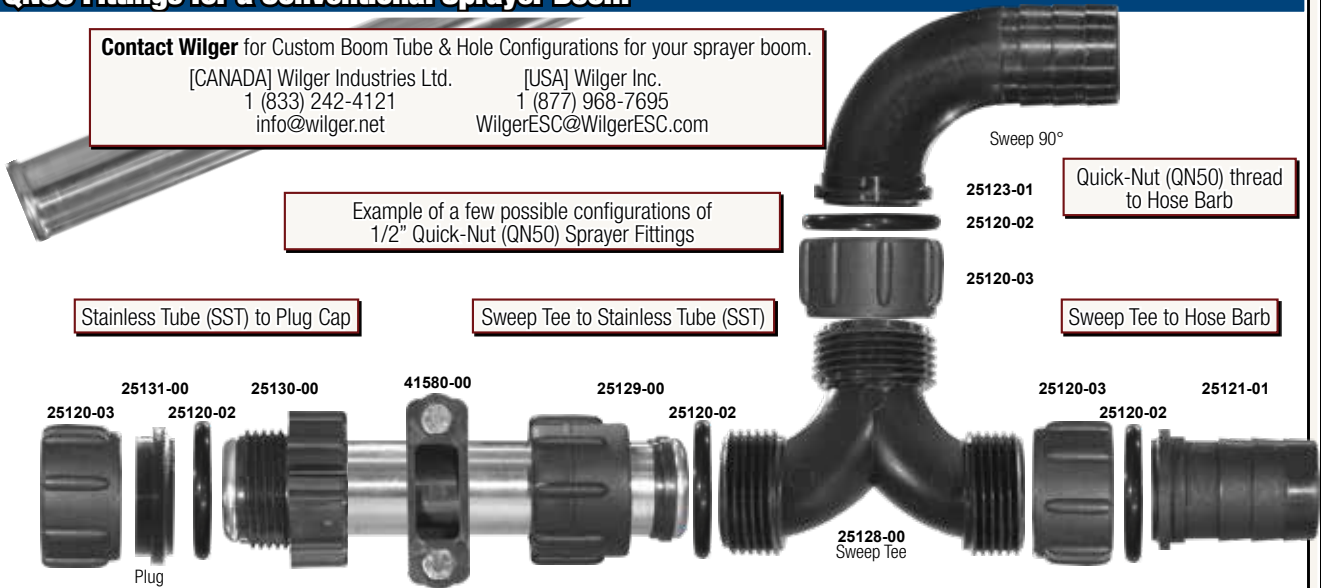

QN50 Connectors & Components

Easy to use boom end fittings and connectors to adapt 1/2" Wilger Stainless Steel Tubing (SST) to QN50 fittings.

Component	Description	Part#
SS Tube End Adapters	Female Thread End, 2pc	25129-00
Quick Nut	Male Thread End, split ring	25130-00
Plug	Nut with QN50-F thread	25120-03
O-ring for QN50 Connections	QN50 x Plug Cap	25131-01
Thread Adapters	#116 O-ring, FKM	25120-02
Boom Clamp	#116 O-ring, viton	25120-V2
	QN100 x 1/4" NPT-F Thread	25127-01
	Half Clamp, 1/2" SST (0.84" OD)	41580-00

For QN50 Connections



25120-02



25131-01



Case® Thin Wall Stainless (TWS) Tube Fittings

Easy to use boom end fittings and connectors to adapt to 1" Case Thin walled stainless steel sprayer booms.

Component	Description	Part#
TWS Male Tube End Adapter (3pc)	Male End Adapter, Left Thread	41400-04
	Male End Adapter, Right Thread	41400-05
	Male End Adapter, Binding Nut	41400-02
Coupler	TWS-F to QN100-F Coupler	41400-01
Quick Nut	TWS Nut, use with QN100 HB	41400-03
O-ring for TWS Connections	#209 square O-ring, FKM	25160-04
	#209 square O-ring, viton	25160-v4
	1" NPT-F x TWS-M Bushing	41403-00
Threaded Adapters	1" NPT-F x TWS-M Bushing kit w/ o-ring	41403-v0
	1" TWS (1.31" OD)	41591-00
Boom Clamp	Flush Valve, Short Handle	41402-V0
	Flush Valve, Long Handle	41402-LV0
Boom End Flush Valves (BEFV) & Replacement Parts	BEFV Seal Repair Kit (2 valves)	25175-11
	BEFV Cover Cap	25175-10
	BEFV Handle, Long	25175-13
	BEFV Handle, Short	25175-03
	3-piece Adapter TWS Male Thread	#41400-04 [Left] #41400-05 [Right] #41400-02 [Binding Nut]



41400-03



25160-04



41403-00



25175-10



TWS Flush Valves

Compact & Robust Full Drain Flush Valve



Case TWS BEFV
41402-LV0

Adapting a TWS Flush Valve to 1" NPT-M End

A bushing kit can adapt to any 1" NPT-M pipe end

41403-v0 BUSHING KIT 41402-V0



Hose Barb Fittings for TWS

TWS Connectors are compatible with QN100 Hose Barb Fittings & Accessories

Size/Style	Description	Part#
Plug	QN100 x Plug Cap	25163-01
Adapters	QN100 x 3/4" NPT-F Thread	25164-01
1" HB x QN100	QN100 x 1" HB, Straight	25166-01
	QN100 x 1" HB, 90° Sweep	25167-01
1-1/4"	QN100 x 1-1/4" HB, Straight	25160-01
Hose Barb x QN100	QN100 x 1-1/4" HB, 45° Sweep	25162-01
	QN100 x 1-1/4" HB, 90° Sweep	25161-01

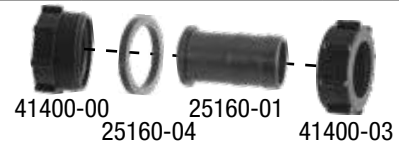

TWS to QN100 Coupler



O-ring Seal (ORS) Fittings & Components

The O-ring Seal (ORS) Fitting Advantage



Superior Chemical Resistance



Stronger Compact Fittings



No Threads or Sealant Required

Hose Barb Inlet



Fittings Swivel 360°

Straight or 90°
4psi/10psi
Check Valves



Full Line of Metering Orifices
Precision metering orifices for rates as low as 1.8 us gal/acre

1/4" to 1" Hose Barb Outlets

1/8" to 3/8" Push-In Tube Quick Connect Outlets

Color-coded ORS Metering Orifices

Standard FKM O-ring Seals
FKM o-rings are used to maximize chemical resistance & durability.

Compatible with Flow Indicators
Wilger ORS fittings are used for both Flow Indicator & EFM systems



50 Mesh inline strainer

1 to 4-Outlet Stackable ORS Manifolds

ORS End Caps & Adapters

ORS to ORS Check Valves

Diaphragm check valves with an ORS-F outlet for in-line outlet control to minimize dripping

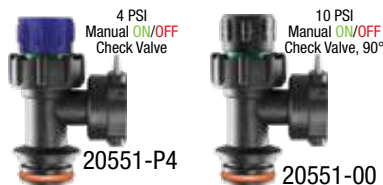

10 PSI Diaphragm Check Valve, 90°
20550-00

Manual ON/OFF Valves



When the knob is **OPEN**, it acts as a standard 10 PSI check valve.
When the knob is **CLOSED**, it turns off flow to that outlet ONLY. It does not turn off flow to any other outlets.

Check Valve Style	90° Outlet	Straight
Dia. Check Valve	20550-00	20555-00
[10psi] Manual On/Off	20551-00	20556-00
[4psi] Manual On/Off	20551-P4	20556-P4
Air-Off Operated	20552-00	20557-00
For PWM/no-check	20553-00	20558-00

*4PSI check valves available: change "-00" to "-P4". For ultra-low flow (<0.01 us gpm), 4PSI may be required.

ORS to COMBO-JET Check Valves

Diaphragm check valves with a Combo-Jet outlet for spray tip or cap metering or spraying.



Check Valve Style	90° Outlet
Dia. Check Valve	20560-00
[10psi] Manual On/Off	20561-00
[4psi] Manual On/Off	20561-P4
Air-Off Operated	20562-00
PWM/no-check	20563-00

COMBO-JET Caps & Metering Orifices

A variety of radlock or COMBO-JET caps & metering orifices are available for hose barb, push-in-tube, spray tips, and other adapters.



ORS Hose Barb Inlets/Outlets

O-ring seal hose barb inlets and outlets. Compatible with all ORS metering orifices.

Hose Barbs	Orientation	Part#
1/4"	Straight	20500-00
	Straight	20501-00
3/8"	90°	20511-00
	Straight	20502-00
1/2"	90°	20512-00
	Straight	20503-00
5/8"	90°	20514-00
	Straight	20503-00
3/4"	90°	20513-00
	Straight	20504-00
1"	90°	20515-00
	Straight	20511-00
	3/8" 90°	20512-00
	1/2" 90°	20513-00
	3/4" 90°	20513-00

ORS Outlet Adapters & Plugs

O-ring seal outlets with female threads, plugs and more. Compatible with all ORS metering orifices for metering flow.

Type	Orientation	Part#
1/4" NPT-F	Straight	20519-00
	90°	20518-00
ORS x Sq Lug	Straight	20549-00
ORS Plug	Straight	20529-00

ORS x Square Lug adapter adapts to any square lug nozzle cap (e.g. Teejet/Hypro/Varitarget)

ORS End Caps & Adapters

O-ring seal end caps are used on any ORS-M ports

Style & Size	Part#	
End Cap	20521-00	
Straight Hose Barb	3/8"	20544-00
	1/2"	20545-00
	3/4"	20547-00
	1"	20548-00
Push-in Tube (seals on O.D.)	1/4"	20540-00
	5/16"	20541-00
	3/8"	20542-00
NPT-F Thread	1/4"	20535-00
	3/8"	20536-00
NPT-M Thread	1/2"	20537-00
	1/4"	20530-00

ORS Splitters & Couplers

Use ORS outlet & end caps to make swiveling, robust o-ring seal splitters, couplers and reducers.



ORS Push-in-Tube Outlets

O-ring seal quick-connect outlets that seal around the outside diameter of a tube. Compatible with ORS orifices

Tube O.D.	Orientation	Part#
1/4"	Straight	20506-00
	Double	20509-00
	90°	20516-00
5/16"	Straight	20508-00
	90°	20528-00
3/8"	Straight	20507-00
	90°	20517-00

Ensure tubes are fully pushed in (at least 5/8" inside housing) for proper sealing and performance 20516-V0 (order -V0 for viton)

Double 1/4" Push-in-tube Splitter 20509-00

1/4" Straight Push-In Tube 20506-00

1/4" 90° Push-In Tube 20516-00

O-ring Seal (ORS) Parts & Manifolds

PRO TIP: Lubricate ORS fittings before assembly

When assembling any flow indicator or O-ring seal (ORS) parts, using a touch of lubricant (e.g. liquid silicone) on the O-ring makes assembly easy.

NEW ORS Inline Strainer

Inline strainer with removable 50-mesh cartridge can be reversed for universal flow direction.



Description	Part#
ORS Strainer Assembly [50 Mesh]	20576-00
Replacement Strainer [50 Mesh]	20576-02
2" ORS Spacer Assy [no strainer]	20576-05

ORS Tees & Other Fittings

A variety of fittings for splitting manifolds, outlets or other auxiliary functions.



Description	Part#
90° ORS Elbow [M x F]	20520-00
ORS Tee w/ 1/4" NPT-F [M x M x F w/ 1/4" NPT-F]	20526-00
3/8" x Blind ORS Tee [Blind F x M x 3/8" NPT-F]	20523-00
3/8" NPT-F x ORS Tee [F x M x 1/8" NPT-F]	20524-00
2-Outlet ORS-F Splitter [F x F x M]	20527-00
1" NPT-F x ORS Tee [M x M x 1" NPT]	20525-00

O-ring Seal (ORS) Manifolds

ORS manifolds can be configured and plumbed to any size, shape or configuration to suit any application equipment needs such as liquid fertilizer manifolds, estate sprayer manifolds, or any other liquid manifold plumbing.





Model	O-ring	Part#
1-Outlet Manifold	FKM	20571-00
	Body only	20571-01
2-Outlet Manifold	FKM	20572-00
	Body only	20572-01
3-Outlet Manifold	FKM	20573-00
	Body only	20573-01
4-Outlet Manifold	FKM	20574-00
	Body only	20574-01

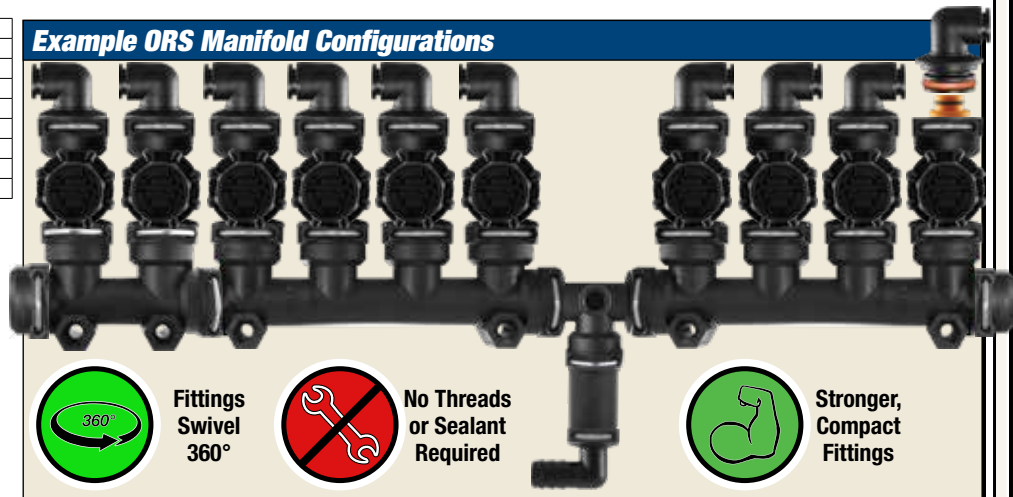

20573-01
Body only
(no u-clips or o-rings)

Example ORS Manifold Configurations





Fittings Swivel 360°



No Threads or Sealant Required



Stronger, Compact Fittings

Replacement Parts for ORS & Flow Indicator Fittings

Replacement components for ORS Fittings/Kits

Product	Type/Material	Part#
Ball Retainer	Polypro	20460-02
U-clip	302 SS	20460-02
Flow Indicator Kit w/o Indicator Body	Manifold Feed	20460-11
	Isolated Feed	20480-02
O-rings for ORS fittings	FKM	20460-03
O-rings for metering orifices	VITON	40225-04

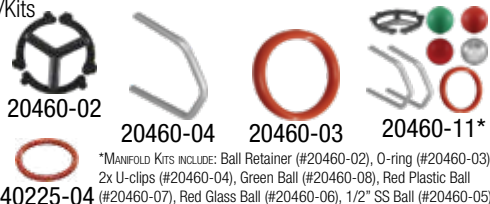

20460-02 20460-04 20460-03 20460-11*

*MANIFOLD KITS INCLUDE: Ball Retainer (#20460-02), O-ring (#20460-03), 2x U-clips (#20460-04), Green Ball (#20460-08), Red Plastic Ball (#20460-06), 1/2" SS Ball (#20460-05)

Mounting Clamps for ORS

Two hole mounting clamps with 1/4" bolt-mount for ORS manifolds and flow indicators

Tube Size	Type	Part#
1" Sq Tube	302 SS	40550-SS
1-1/4" Sq Tube	302 SS	40551-SS
1-1/2" Sq Tube	302 SS	40552-SS



O-ring Seal (ORS) Metering Orifices & Charts

Precise metering orifices for metering liquid fertilizers, or chemicals. The easier-to-handle orifices fit in any O-ring seal (ORS-M) fitting port, and cannot be inserted backwards. Available in precision molded color-coded sizes or custom drilled sized orifices.

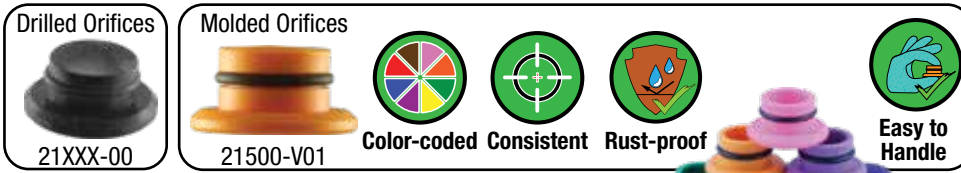

Metering Orifice type, seal & ORS Orifice Part#	Molded ORS Orifice VITON O-ring	Custom Drilled Orifice FKM/viton O-ring	Blank Orifice/Plug FKM/viton O-ring
Color	Color-coded*	Black	Black



Use TIP WIZARD for metering orifice selection

Available on www.WILGER.NET

Download on the App Store

GET IT ON Google Play

Simply input rate, speed & spacing, and get the best orifice for the job.

Calculating required flow for metering orifice selection

To determine the flow rate (or application rate), use the following equations & density conversion chart:

W = Outlet Spacing (INCH)
conv = Conversion Factor based on specific gravity/weight of liquid

$$GPM = \frac{GPA \times mph \times W \times conv}{5940}$$

$$GPA = \frac{5940 \times GPM \text{ (per outlet)}}{mph \times W \times conv}$$

Solution Weight (lbs/ us gallon)	Specific Gravity	Conversion Factor (conv)
8.34 (Water)	1.00	1.00
10.65 (28-0-0)	1.28	1.13
11.65 (10-34-0)	1.39	1.18

EASY-TO-USE ORS orifice and ball selector calculator available @ www.WILGER.NET

Orifice Part#*	Flow Rate (US gallons/minute)							Orifice Part#*	Flow Rate (US gallons/minute)						
	10PSI	15PSI	20PSI	25PSI	30PSI	35PSI	40PSI		10PSI	15PSI	20PSI	25PSI	30PSI	35PSI	40PSI
21009-XX	0.005	0.006	0.007	0.008	0.009	0.010	0.010	21075-XX	0.346	0.424	0.490	0.548	0.600	0.648	0.693
21011-XX	0.008	0.010	0.011	0.013	0.014	0.015	0.016	21078-XX	0.387	0.474	0.547	0.612	0.670	0.724	0.774
21013-XX	0.011	0.013	0.016	0.017	0.019	0.021	0.022	21500-V03	0.393	0.433	0.533	0.630	0.690	0.745	0.797
21015-XX	0.014	0.018	0.020	0.023	0.025	0.027	0.029	21081-XX	0.410	0.502	0.580	0.648	0.710	0.767	0.820
21500-V003	0.015	0.018	0.021	0.024	0.026	0.028	0.030	21083-XX	0.450	0.552	0.637	0.712	0.780	0.842	0.901
21018-XX	0.021	0.025	0.029	0.033	0.036	0.039	0.042	21086-XX	0.468	0.573	0.661	0.739	0.810	0.875	0.935
21500-V005	0.025	0.030	0.035	0.039	0.043	0.046	0.050	21089-XX	0.491	0.601	0.694	0.776	0.850	0.918	0.981
21020-XX	0.026	0.032	0.037	0.041	0.045	0.049	0.052	21500-V10	0.502	0.615	0.710	0.794	0.870	0.940	1.00
21022-XX	0.031	0.037	0.043	0.048	0.053	0.057	0.061	21091-XX	0.525	0.643	0.743	0.831	0.910	0.983	1.05
21500-V007	0.033	0.041	0.047	0.053	0.058	0.063	0.067	21093-XX	0.548	0.672	0.776	0.867	0.950	1.03	1.10
21025-XX	0.039	0.048	0.056	0.062	0.068	0.073	0.079	21096-XX	0.589	0.721	0.833	0.931	1.02	1.10	1.18
21026-XX	0.043	0.053	0.061	0.068	0.075	0.081	0.087	21500-V125	0.624	0.764	0.882	0.986	1.08	1.17	1.25
21027-XX	0.046	0.056	0.065	0.072	0.079	0.085	0.091	21102-XX	0.652	0.799	0.923	1.03	1.13	1.22	1.30
21028-XX	0.049	0.060	0.069	0.078	0.085	0.092	0.098	21104-XX	0.675	0.827	0.955	1.07	1.17	1.26	1.35
21500-V01	0.050	0.062	0.071	0.079	0.087	0.094	0.100	21107-XX	0.733	0.898	1.037	1.16	1.27	1.37	1.47
21029-XX	0.064	0.078	0.090	0.100	0.110	0.119	0.127	21500-V15	0.751	0.919	1.061	1.19	1.30	1.40	1.50
21031-XX	0.064	0.078	0.090	0.100	0.110	0.119	0.127	21110-XX	0.774	0.948	1.094	1.22	1.34	1.45	1.55
21500-V015	0.075	0.092	0.106	0.119	0.130	0.140	0.150	21113-XX	0.820	1.00	1.16	1.30	1.42	1.53	1.64
21035-XX	0.081	0.099	0.114	0.128	0.140	0.151	0.162	21116-XX	0.860	1.05	1.22	1.36	1.49	1.61	1.72
21037-XX	0.087	0.106	0.122	0.137	0.150	0.162	0.173	21120-XX	0.889	1.09	1.26	1.41	1.54	1.66	1.78
21039-XX	0.098	0.120	0.139	0.155	0.170	0.184	0.196	21125-XX	0.981	1.20	1.39	1.55	1.70	1.84	1.96
21500-V02	0.104	0.127	0.147	0.164	0.180	0.194	0.208	21500-V20	0.999	1.22	1.41	1.58	1.73	1.87	2.00
21041-XX	0.110	0.134	0.155	0.173	0.190	0.205	0.219	21128-XX	1.02	1.25	1.45	1.62	1.77	1.91	2.04
21043-XX	0.115	0.141	0.163	0.183	0.200	0.216	0.231	21130-XX	1.06	1.30	1.50	1.68	1.84	1.99	2.12
21500-V025	0.127	0.156	0.180	0.201	0.220	0.238	0.254	21136-XX	1.19	1.46	1.68	1.88	2.06	2.23	2.38
21046-XX	0.133	0.163	0.188	0.210	0.230	0.248	0.266	21140-XX	1.26	1.55	1.79	2.00	2.19	2.37	2.53
21047-XX	0.139	0.170	0.196	0.219	0.240	0.259	0.277	21144-XX	1.31	1.61	1.85	2.07	2.27	2.45	2.62
21049-XX	0.150	0.184	0.212	0.237	0.260	0.281	0.300	21147-XX	1.35	1.65	1.90	2.13	2.33	2.52	2.69
21500-V03	0.150	0.184	0.212	0.237	0.260	0.281	0.300	21150-XX	1.44	1.77	2.04	2.28	2.50	2.70	2.89
21051-XX	0.162	0.198	0.229	0.256	0.280	0.302	0.323	21152-XX	1.49	1.82	2.11	2.36	2.58	2.79	2.98
21052-XX	0.167	0.205	0.237	0.265	0.290	0.313	0.335	21156-XX	1.55	1.90	2.20	2.46	2.69	2.91	3.11
21055-XX	0.191	0.233	0.269	0.301	0.330	0.356	0.381	21161-XX	1.63	2.00	2.31	2.58	2.83	3.06	3.27
21500-V04	0.202	0.247	0.286	0.320	0.350	0.378	0.404	21166-XX	1.71	2.10	2.42	2.71	2.97	3.21	3.43
21060-XX	0.225	0.276	0.318	0.356	0.390	0.421	0.450	21172-XX	1.88	2.31	2.66	2.98	3.26	3.52	3.76
21061-XX	0.231	0.283	0.327	0.365	0.400	0.432	0.462	21177-XX	2.00	2.45	2.83	3.16	3.46	3.74	4.00
21063-XX	0.248	0.304	0.351	0.393	0.430	0.464	0.497	21182-XX	2.08	2.55	2.95	3.30	3.61	3.90	4.17
21500-V05	0.254	0.311	0.359	0.402	0.440	0.475	0.508	21187-XX	2.21	2.70	3.12	3.49	3.82	4.13	4.41
21064-XX	0.254	0.311	0.359	0.402	0.440	0.475	0.508	21196-XX	2.45	3.00	3.46	3.87	4.24	4.58	4.90
21065-XX	0.260	0.318	0.367	0.411	0.450	0.486	0.520	21205-XX	2.65	3.25	3.75	4.19	4.59	4.96	5.30
21067-XX	0.277	0.339	0.392	0.438	0.480	0.518	0.554	21213-XX	2.85	3.49	4.03	4.51	4.94	5.34	5.70
21500-V06	0.300	0.368	0.425	0.475	0.520	0.562	0.600	21218-XX	2.98	3.65	4.21	4.71	5.16	5.57	5.96
21070-XX	0.306	0.375	0.433	0.484	0.530	0.572	0.612	21234-XX	3.47	4.25	4.91	5.49	6.01	6.49	6.94
21073-XX	0.329	0.403	0.465	0.520	0.570	0.616	0.658	21250-XX	4.00	4.90	5.66	6.33	6.93	7.49	8.00

Wilger Visual Ball Flow Indicators

The Flow Indicator Advantage See Any Application Accurately



Fittings Swivel
360°



Clear Sight Column



Superior Chemical Resistance



Simple, without Electronics



No Threads or Sealant Required

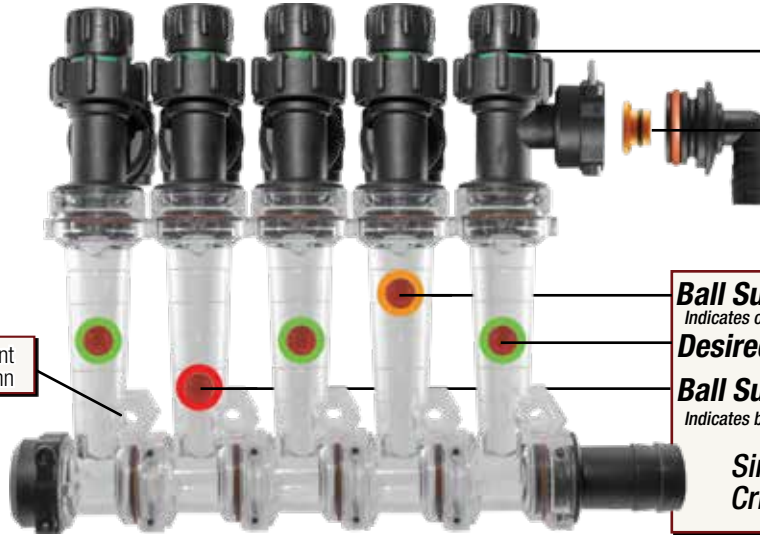

1/4" Bolt mount on each column

Manual ON/OFF Check Valves
Easy to turn off for maintenance or convert equipment to mid-row banding

Larger Metering Orifices
Easier handling & cleaning

Consistent Metering & Easy Cleaning

Ball Suspended Higher
Indicates over flow or leak

Desired Flow

Ball Suspended Lower
Indicates blockage or plug

Simple Operation. Critical Feedback.

Example of flow indicator function; Overlay colors are for visual purposes only

Flow Indicators are used on Planting Equipment & Sprayers to indicate relative flow blockage or overage.

Manifold Feed - Ball Flow Indicators

For monitoring many lines from a single feed (e.g. Liquid fertilizer kits for a planter)

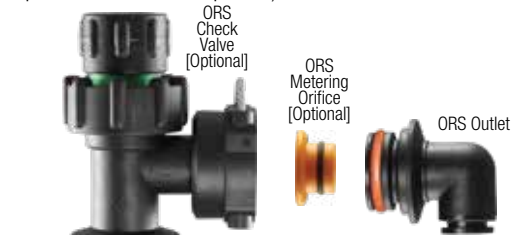

Model	Kit Type*	Part#
Ultra Low Flow [0.01-0.24 us gpm]	Bulk Kit	20475-BULK
	Bagged Kit	20475-00
	Body Only	20475-01
Low Flow [0.05-0.65 us gpm]	Bulk Kit	20470-BULK
	Bagged Kit	20470-00
	Body Only	20470-01
Standard Flow [0.07-2.70 us gpm]	Bulk Kit	20460-BULK
	Bagged Kit	20460-00
	Body Only	20460-01

*MANIFOLD KITS INCLUDE: Indicator Body, Ball Retainer (#20460-02), O-ring (#20460-03), 2x U-clips (#20460-04), Green Ball (#20460-08), Red Plastic Ball (#20460-07), Red Glass Ball (#20460-06), 1/2" SS Ball (#20460-05)

Ball Retainer

Sight Column

Red Glass Ball

1/4" Bolt-Mount Hole

Stackable ORS-F port for inlet

Stackable ORS-M port can be capped off

Flow Indicator & ORS Specifications*

Max Operating Pressure: 100PSI / 7BAR
Max Metered Flow Rate: Up to 8.0 us gpm
Max Operating Pressure: 185°F / 85°C
O-ring Seals: FKM (standard) / Viton
U-clip/Metal Fittings: Stainless Steel (302)
ORS Fittings: Glass-reinforced Polypropylene
Flow Columns: TPX™ (Polymethylpentene)

Isolated Feed - Ball Flow Indicators

For monitoring single lines from individual feeds (e.g. Squeeze pump monitoring, chemical injector pumps)



Model	Kit Type**	Part#
Low Flow [0.05-0.65 us gpm]	Bulk Kit	20490-BULK
	Bagged Kit	20490-00
	Body Only	20490-01
Standard Flow [0.07-2.70 us gpm]	Bulk Kit	20480-BULK
	Bagged Kit	20480-00
	Body Only	20480-01

**ISOLATED KITS INCLUDE: Flow Indicator Body, Ball Retainer (#20460-02), U-clip (#20460-04), Green Ball (#20460-08), Red Plastic Ball (#20460-07), Red Glass Ball (#20460-06), 1/2" Stainless Ball (#20460-05)

Inlet feed uses Combo-Jet cap. Refer to COMBO-JET caps & adapters.

How to Tell Columns Apart? Check the top of the column.

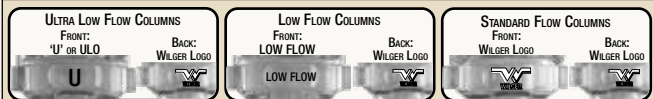

Required Storage for Flow Indicator Columns

Wilger Flow Indicator columns are made of a specialty UV-stabilized compound (TPX™) that maximizes chemical resistance, providing compatibility for a huge range of chemical applications.

As with any plastic, UV exposure degrades the flow indicator columns.
To maximize flow indicator column clarity & longevity, completely cover the flow indicator columns from UV exposure (sun/etc.) when not in use.

PRO TIP: Using two balls simultaneously helps adapt to cover changes in rate & speed

If a lighter ball is suspended too high, using the next heavier ball below can help cover changes in application rates or speeds.



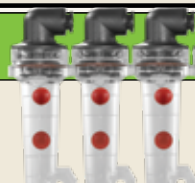





Red Celcon Ball Lower Rate/Speed
Red Glass Ball Higher Rate/Speed



Wilger Visual Ball Flow Indicators - Balls & Setup Guide

Flow Indicator Balls & Selection Chart

Weighted balls are used inside flow indicator columns and within the operational flow range, will suspend within the column, showing relative flow rate to other flow columns.

Ball Description & Color	Part #	Flow Indicator Columns & Flow Ranges*		
		Ultra Low Flow	Low Flow	Standard Flow
 Orange Polypropylene Ball*	20460-13	0.01-0.04 us gpm	0.05-0.12 us gpm	0.07-0.25 us gpm
 Green Polypropylene Ball*	20460-08	0.01-0.04 us gpm	0.05-0.12 us gpm	0.07-0.25 us gpm
 Red Celcon Ball*	20460-07	0.02-0.06 us gpm	0.06-0.16 us gpm	0.10-0.35 us gpm
 White Celcon Ball*	20460-18	0.02-0.06 us gpm	0.06-0.16 us gpm	0.10-0.35 us gpm
 Pink Celcon Ball*	20460-14	0.02-0.06 us gpm	0.06-0.16 us gpm	0.10-0.35 us gpm
 Red Glass Ball	20460-06	0.06-0.13 us gpm	0.12-0.26 us gpm	0.21-0.72 us gpm
 1/2" Stainless Steel (302) Ball	20460-05	0.13-0.24 us gpm	0.18-0.65 us gpm	0.40-1.70 us gpm
 7/16" Stainless Steel (302) Ball	20460-10	n/a	n/a	1.00-2.70 us gpm

*Density/Viscosity of liquid used can effect operating range. In very dense liquids, balls may float.

Applying Dark Fertilizers & Variable Rate Applications

With some liquid fertilizers and products being darker (e.g. humic acid content), consider a few tips that may help visual representation of flow.

For Red Liquids
(e.g. Paralign Fertilizer)
White backboard for improved visibility.
White celcon ball for red liquids.



For Dark Liquids
(e.g. Humic Acid)
Pink celcon ball for black & dark liquids.



For Variable Rate
Considering using two balls to better illustrate changes in flow rate. Select a lighter ball for the lower rate, and heavier for the higher rate.



Ball Selection Example

Liquid Weight: 10.67 lbs/ US Gallon
Speed: 5 mph
Outlet Spacing: 30 inch



Ultra-Low Flow
Rate: 4.5 US Gal/Acre
Flow Rate: 0.129 us gpm
Ball: Red Glass



Low Flow
Rate: 10 US Gal/Acre
Flow Rate: 0.286 us gpm
Ball: 1/2" Stainless



Standard Flow
Rate: 20 US Gal/Acre
Flow Rate: 0.571 us gpm
Ball: Red Glass

Guide to Building a Liquid Kit with Flow Indicator Manifolds

STEP 1 Select: Manifold-Feed or Isolated-Feed Style Flow Columns

Choose the style of flow column that suits the application equipment being monitored

STEP 2 Determine Flow Indicator Column Size (e.g. Ultra Low Flow, Low Flow, Standard Flow)

Depending on the flow rates required, select the flow column that would provide the best fit to the required flow rate or range. Usually this is accomplished by finding a column size that has your flow rate towards the middle of the range or higher.

STEP 3 Select: Flow Indicator Balls to use

Consult the ball flow chart to determine which balls should be used. It can be optional to use two balls to illustrate a flow rate range.

STEP 4 ORS Check Valves [Optional]

A variety of check valves are available. Typically an ORS to ORS check valve would be used unless adapting a manifold to combo-jet caps. One check valve is required per flow indicator.

STEP 5 ORS Inlet Feeds, Tees, & Strainers

Determine how many manifolds are required, whether the manifolds are fed with a Tee fitting, as well as whether an inline strainer will be added to each manifold. Determine the size & type of inlet fitting. One set of inlet/tee/strainer is required per manifold.

STEP 6 ORS Metering Orifices [Optional]

Any metering manifold should have a means to meter the flow for each row to keep rows consistent. Without a metering orifice, the flow rates between rows can vary greatly. One metering orifice would be required per flow indicator column.

STEP 7 ORS Outlet

Select the size, and style of outlet to be used for each row of product. Consider applying a small bit of lubricant (e.g. liquid silicone) on the o-ring to air in easy installation of outlets and other ORS fittings. The outlet would hold the ORS metering orifice, if used.

STEP 8 ORS End Caps & Adapters

A variety of end caps are available as adapters which can be used for many situations, but typical an ORS end cap would be used. Two end caps are required per manifold if a Tee fitting is used.

Do you plant at night or in low visibility? Take a look at Wilger's Electronic Flow Monitoring (EFM) System

Wilger's row-by-row flowmeter uses the same ORS parts and manifolds, and can be simply added inline for existing manifolds.

Simply add a flowmeter for each row and connect the electronic harness to see actual flow rate on each row (up to 200 rows), for flow rates of 0.04-1.53 us gpm flow.

Flowmeter can also be installed on flow indicators to provide greater accuracy



Wilger Electronic Flow Monitoring System

The Electronic Flow Monitoring Advantage

See Any Application with Row-by-Row Accuracy

The Wilger electronic flowmeter (EFM) is a service-able flowmeter designed & built specifically for agricultural chemical & liquid applications.



Fittings Swivel 360°



Crystal Clear Flowmeter



Superior Chemical Resistance



Serviceable Flowmeter for Ag.



High Accuracy Flowmeter



Patented Flowmeter
Canadian Patent No. 2987646
AUS Patent No. 2017376849
U.S. Patent No. 10,845,228

Crystal Clear Flowmeters
Enables easy system troubleshooting & verification

Monitors Huge Flow Range
Accurately measures flow rates of 0.04-1.53 us gpm per row

How It Works
High Resolution Hall-Effect Sensor & Ceramic Magnet combo provide accurate pulse frequency to determine flow

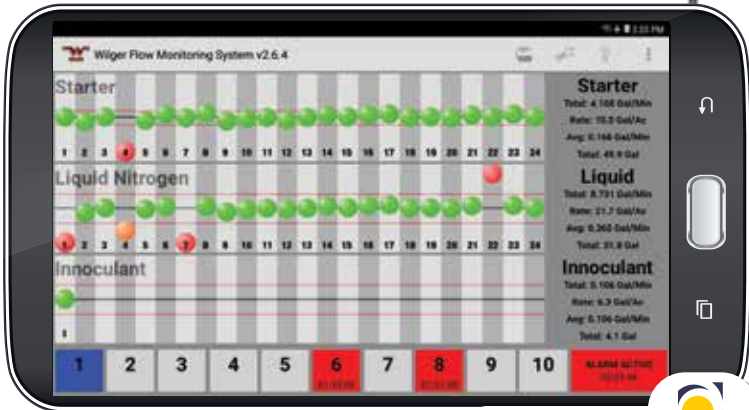
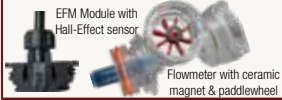

FREE EFM APP POWERED BY AGTRON

The Electronic Flow Monitoring system (powered by Agtron) requires an Android Tablet 8.0 or later.

Trouble-free Connectors
Keyed Deutsch connectors ensure weather-sealed wiring

Monitor up to 3 Products
Simultaneously monitor up to 3 products within the same system

Monitor Any Sized Equip.
Monitor up to 200 rows or outlets on any equipment

Custom High/Low Alarms
Customize threshold alarms

Custom Screen Layouts
Customize screen layouts between products, sections, or any other way

Chemical Resistance
Clear TPX material provides visual & non-stick surface

Easy Retrofit
Easily retrofits to any existing ORS or Flow Indicator Fittings

Simple Harnessing
Composed of an ECU with dairy-chained product nodes & sensors

WiFi communication
ECU generates WiFi straight into the cab

Build your Electronic Flow Monitoring System with help from www.wilger.net



Use the new EFM system parts kit builder available at www.wilger.net. Simply input your implement size and layout and receive a parts list & quote. Simple as that.

Compact ECU for Demo Units & Planters up 16 Rows

NEW



Wilger is introducing a compact flow monitoring system ECU, that acts as a standard ECU with built-in 16 channel node.

For an even easier setup for in-store demonstration or as fully functional <16-row planter EFM systems.

Available now in limited quantities.
Book yours today!

Wilger Electronic Flow Monitoring System Components

Electronic Flowmeters & Jets

A clear flowmeter that connects to any ORS outlets, with an accurate flow range of 0.04 - 1.53 us gpm, using patented flow stabilizing jets.

20580-00 EFM KIT
Includes 4 Sizes of EFM jet

20580-06 Body Assembly
EFM BODY ASSY
[no jets, wire side showing]

Front View: ORS-M Inlet w/ inserted jet and strainer, ORS-F Outlet

Back View

Product	Description	Part#
Electronic Flowmeter Body [0.04-1.53 us gpm]	Flowmeter Kit	20580-0
	Body Assembly (no jets)	20580-06
	Body Only	20580-01
Replacement Jets (with 50 mesh snap-in strainer)	Green (up to 0.12 us gpm)	20581-01
	Red (0.1 - 0.31 us gpm)	20581-03
	Blue (0.18 to 0.98 us gpm)	20581-05
	Black (0.6 to 1.53 us gpm)	20581-07

*Jets include snap-in strainers for easy handling

Required Storage for Flowmeters

Wilger Flowmeters are made of a specialty UV-stabilized compound (TPX™) that maximizes chemical resistance, providing compatibility for a huge range of chemical applications. As with any plastic, UV exposure degrades the flow indicator columns.

To maximize flowmeter clarity & longevity, completely cover the flowmeters from UV exposure (sun/etc.) whenever possible.

Electronic Flowmeter Manifolds

Pre-assembled manifolds in 1-4 Outlets with a flowmeter and check valve. Simply stack manifolds, then add inlet/outlets, caps and sensor cables.

20644-00 Four Outlet EFM Manifold Kit w/ Check Valve
Kit includes 20574-00, 4x 20580-00, 4x 20556-00

- Stack manifold sections to desired size.
- Add ORS inlet or center-fed tee
- Add ORS end-cap (2x if TEE is used)
- Add ORS outlets & metering orifice (opt.)

[Included] 20581-XX EFM Jet set [1 set per EFM]

Manifold Outlets	Check Valve*	Part#
1 EFM Outlet	Straight	20641-00
	90°	20631-00
2 EFM Outlet	Straight	20642-00
	90°	20632-00
3 EFM Outlet	Straight	20643-00
	90°	20633-00
4 EFM Outlet	Straight	20644-00
	90°	20634-00

*4PSI check valves available: change '-00' to '-P4'. For ultra-low flow (<0.01 us gpm), 4PSI may be required.

Base Electronic Kits for EFM Systems

Electronic Control Units (ECU) & components used in EFM systems. ECUs are used to monitor up to 196 outlets, across up to 3 products.

Product	Kit Includes	Part#
ECU100 Base Kit	ECU100, 12v Harness, Terminator, Antenna	20603-00
ECU Splitter Kit	ECU Splitter Cable, Terminator	20605-00
DEMO ECU Kit	DEMO ECU, incl. node harness, CAN power	20603-00
ECU/Node to Node	12' Extension Harness (Node to ECU/Node)	20616-12
Extension Harness	24' Extension Harness (Node to ECU/Node)	20616-24

20603-00 ECU100 Base Kit, Breakdown

- 20604-00 Terminator**: Connects to last node in series
- 20603-02 20' Battery Harness w/ Deutsch Connector**: 20' Length
- 20603-01 WIFI ECU**: Connects to First Node Harness
- 20603-03 Antenna**

20605-00 ECU Splitter Kit

20605-01 Y Splitter

20604-00 Terminator used at end of each series

- Connects to ECU.
- Connects to Node 1 in first node loop.
- Connects to 2nd node series. Node # determined by last node in 1st series.

20625-00 DEMO ECU Kit

for Demo units & up to 16 row planters
Compact ECU can be wired to Tablet, or WIFI

- 20625-01 Compact ECU**
- 20603-03 Antenna**
- 20625-03 CAN to 12v Power Harness**: 7' Length
- 20625-02 Compact ECU Product Harness***

*Compact ECU product harness is not expandable

Using an ECU Splitter Cable - Navigating Node Numbers & Labels

Example: NODE 3 was designated #3 by position, due to NODE 2 closing the series with a terminator.

Terminators are required for the end of each node daisy-chained loop.

Pause Count @ Terminator: Resume count at Y-splitter cable '3'

Last Node @ Terminator

From ECU

After the terminator at the end of Y-splitter cable '2', resume counting node numbers at the node connected to the Y-splitter cable labeled '3'.

Wilger Electronic Flow Monitoring System Components

16 Channel (16CH) Product Node Kits & Components

16CH Product nodes provide communication between sensors and ECU.

Product	Description	Part#
16CH Node Kit	incl. 16CH Node, 16CH Harness, 4x Quad-sensor cables	20621-00
Quad-Sensor Cable	4-Sensor Cable (18" long) for 16CH Node	20585-00
16CH Node/Harness	incl. 16CH Product Node, 16CH Node Harness	20611-00
16CH Harness Cap	16CH Harness Cover Cap	20612-00
Sensor Cover Cap	Covers a single sensor on a quad-sensor cable	20585-01
Node to Quad-Sensor Extensions	6' Extension Cable (16CH Harness to quad-sensor cable)	20615-06
	12' Extension Cable (16CH Harness to quad-sensor cable)	20615-12

Capping Unused Connections & Sensors

For proper function of your EFM system, each unused connection must be sealed with a node harness cover cap, sensor cap, or terminator. Unsealed Connections have increased chance of shorts, electrical shock, or damage to the system or equipment.

Unused Node Connections

Cap unused A/B/C/D with 16CH node harness
#20612-00

Terminators

Cap all "last node" connections
#20604-00

Unused Sensors

Cap unused sensors with rubber cap
#20585-01

20621-00 16 CHANNEL (16CH) NODE KIT BREAKDOWN

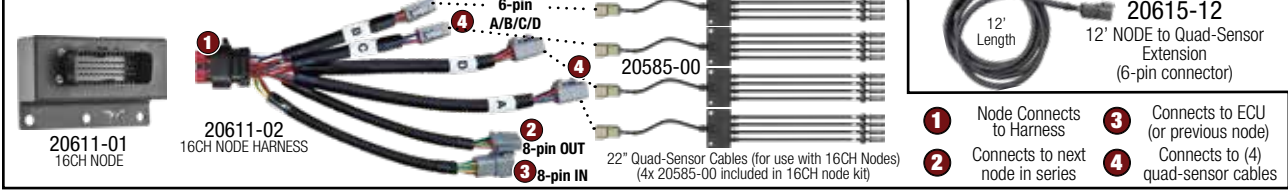

Limited Stock

4 Channel (4CH) Product Node Kits & Components

4 Channel Product Nodes & kits provide communication between sensors and ECU. Sensor cables cannot be interchanged between 16CH and 4CH node harnesses. 4CH nodes and sensors are available in limited stock, as Wilger is transitioning to using the 16CH node and components as standard.

Product	Description	Part#
4CH Node Kit	incl. 4CH Node, 4CH Harness, 4x 6" single-sensor cables	20620-00
4CH Node/Harness	incl. 4CH Product Node, 4CH Node Harness	20608-00
4CH Harness Cap	4CH Harness Cover Cap	20609-00
Single-Sensor Cables (lim. qty)	6" single-sensor Cable for 4CH Node harness	20584-00
	10' single-sensor Cable for 4CH Node harness	20584-10

Capping Unused Connections

For proper function of your EFM system, each unused connection must be sealed with a 4CH node harness/sensor cover cap, or terminator.

Unused Sensor Connections

Cap unused 4CH node harness connections
#20609-00

Terminators

Cap all "last node in series" connections
#20604-00

20620-00 4 CHANNEL (4CH) NODE KIT BREAKDOWN

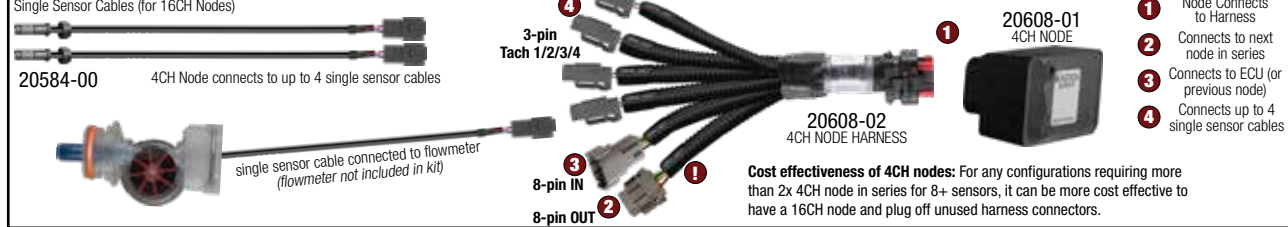

Cost effectiveness of 4CH nodes: For any configurations requiring more than 2x 4CH node in series for 8+ sensors, it can be more cost effective to have a 16CH node and plug off unused harness connectors.

ECU Splitters, Extended Harnesses & Cables

A variety of harnesses available for alternate EFM system configurations or replacement cables and caps

Product	Description	Part#
12v Power Extension	Extends 2-pin power connection by 35'	20603-07
Antenna Extension	Extends connection to ECU antenna, 30' length	20603-05
4' Quad-sensor Cbl	4' Long Quad-sensor cable (48"/20"/20"/48")	20585-04
10' Single Sensor Cbl	10' long single sensor cable	20584-10
Node to Node Extensions	12' Extension Cable (8-pin Harness male to 8-pin female)	20616-12
	24' Extension Cable (8-pin Harness male to 8-pin female)	20616-24
Node to Quad-Sensor Extensions	6' Extension Cable (16CH Harness to quad-sensor cable)	20615-06
	12' Extension Cable (16CH Harness to quad-sensor cable)	20615-12

30' Antenna Extension

30' co-axial antenna extension cable to bring ECU antenna closer to the tractor

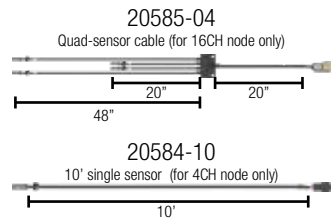

Extensions: ECU/Node to Node

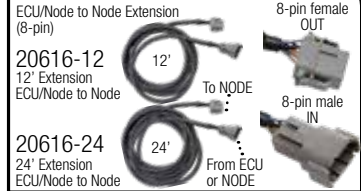

Extensions: Node to Quad-sensor

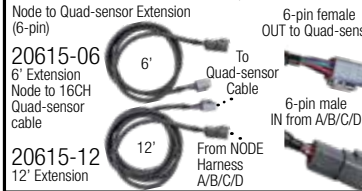

12v power Extension

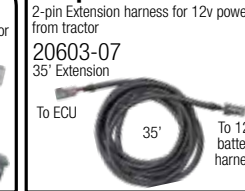

20605-00 ECU Splitter Kit

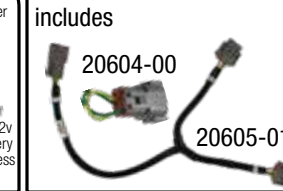

Flowmeter Component Parts

Electronic flow monitoring system parts and components are easily replaceable. For individual component parts that were not listed in the above product breakdowns, find the below.

- 20580-06 EFM, Body Assy, TPX, ORS (no jets, body assy only)
- 20580-01 EFM, Body Only, TPX
- 20580-02 EFM, Module c/w O-ring (no sensor)
- 20580-08 EFM, Impeller Assembly (20580-08 + 20580-10)
- 20580-10 EFM, Impeller Magnet, Ceramic
- 20580-11 EFM, Impeller Axle Pin
- 20580-13 EFM, O-Ring, #119, VITON® (for EFM module)
- 20583-00 EFM Sensor Cable, Single w/o Connector
- 20585-01 EFM sensor rubber cover (for unused sensor cables)



EFM Retrofit Options

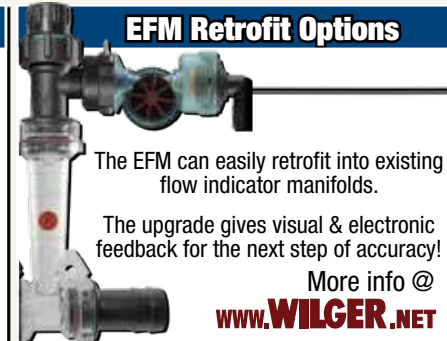

The EFM can easily retrofit into existing flow indicator manifolds.

The upgrade gives visual & electronic feedback for the next step of accuracy!

More info @ www.WILGER.NET

Wilger Electronic Flow Monitoring System ECU100 Example

ECU100 on a 16-row Planter, applying liquid fertilizer

Expand system to larger planters or implements by simply adding 16CH nodes in series

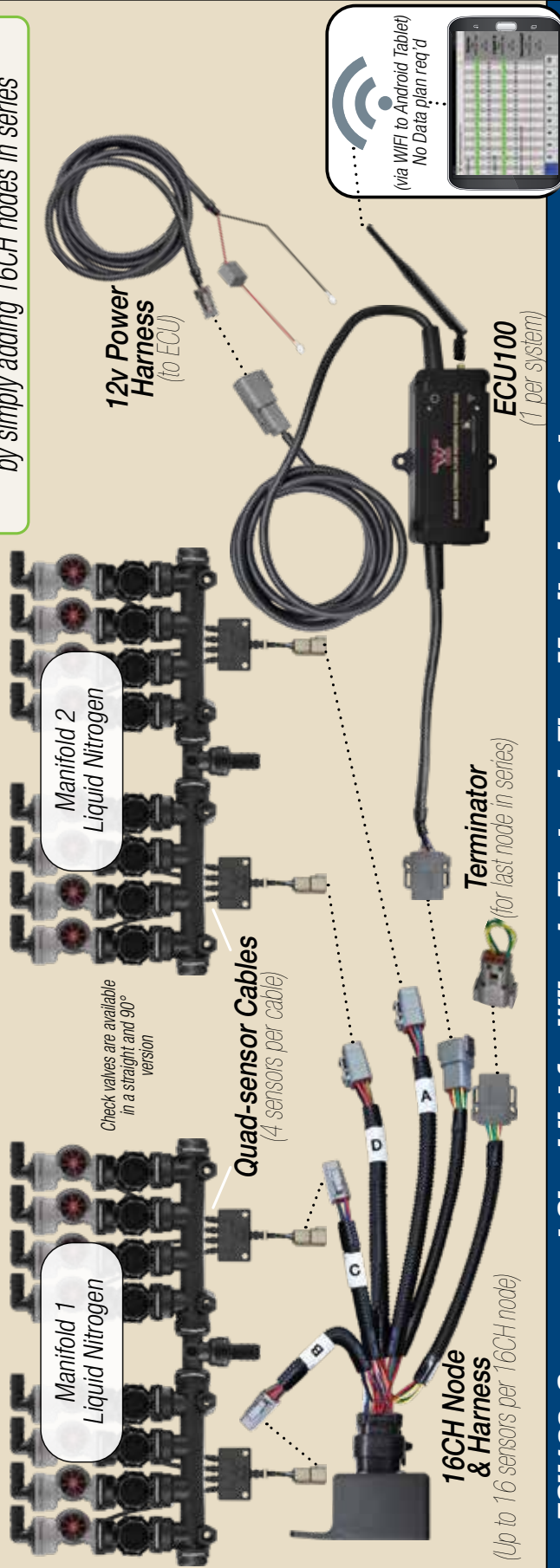

ECU100: Component Checklist for Wilger's Electronic Flow Monitoring System

As equipment & implements greatly vary, this is a simplified approach assuming the implement is fairly standard and evenly spread, with the manifold centrally located. It may be cost effective to move manifolds from the wings of the implement, to the center.

- 1 Order 1 ECU100 kit per system. (#20603-00)
- 2 Add the # of outlets (including multiples for monitoring multiple products). Divide the total # of outlets by 16. Round up to nearest whole number. Order that many 16CH Node kits. (#20621-00) 4CH Node Kits can be effective for "extra" outlets in systems, but 16CH node kits are typically cost effective.
- 3 Order 1 EFM assembly kit (#20580-00) per outlet (incl. multiples for monitoring multiple products). Alternatively, order EFM manifold kits (#20631-00 to #20634-00) to fit your requirements for sections.
- 4 Order 1 ORS Outlet (Page 16) & 1 ORS Check Valve (#20551-00) per EFM body. Order manifolds & plumbing components (& end caps) suited for the implement size.
- 5 [Optional if metering orifice req'd] Order an ORS orifice for each outlet, ensure proper metering orifice size for each rate. Use Tip Wizard @ www.wilger.net or via app, to ensure proper sizing.

EFM System Checklist for ECU100

ELECTRONICS Parts	PLUMBING Parts
<input type="checkbox"/> 1x ECU100 KIT per system	<input type="checkbox"/> 1x ORS Manifold Outlet per outlet
<input type="checkbox"/> 1x 16CH Node Kit per 16 outlets	<input type="checkbox"/> 1x ORS Outlet Fitting per outlet
<input type="checkbox"/> 1x Flowmeter (EFM) per outlet	<input type="checkbox"/> 1x ORS Check Valve per outlet
<input type="checkbox"/> Extension harnesses if req'd	<input type="checkbox"/> 1x Inlet Feed or Tee per manifold
<input type="checkbox"/> 1x Android Tablet (Android 8.0 OS or newer)	<input type="checkbox"/> 1x End Cap per manifold (2x if center Tee)
	<input type="checkbox"/> 1x Metering Orifice per outlet (or alt.)

For more information, start the conversation on building your EFM system with your Wilger dealer, and for more pictures/information, visit our website at: www.WILGER.NET

Build your EFM system liquid kit on www.WILGER.NET

Use the new EFM system parts kit builder available at www.wilger.net. Simply input your implement size and layout and receive a parts list & quote. Simple as that.



EFM VIDEO TUTORIALS - Setting up EFM App on Android Tablet

Make sure to take advantage of video tutorials on initial setup and planning of EFM system app on your Android Tablet. Videos on YOUTUBE, or accessible from www.WILGER.NET

EFM System App Preview - Setup & Go

- 1 Download the Wilger Electronic Flow Monitoring System App. (GooglePlay Store, or APK download from www.wilger.net/efm.apk)
- 2 Power up ECU, connect tablet to ECU WIFI, and complete ECU setup, including specifying product-specific alarm, outlet spacing & jet selection. (WIFI password is ECU serial number; eg. "WILGER_EFI_1234567")
- 3 Set row/outlet locations (on screen) by pairing row # and physical location of sensor (which node/cables it is connected to). Customize page layout by preference (group balls by sections or any other layout by user preference).
- 4 System will now monitor each individual flowmeter individually (on detailed snapshot screen and alarms), by product (with visual balls), and as a whole system.

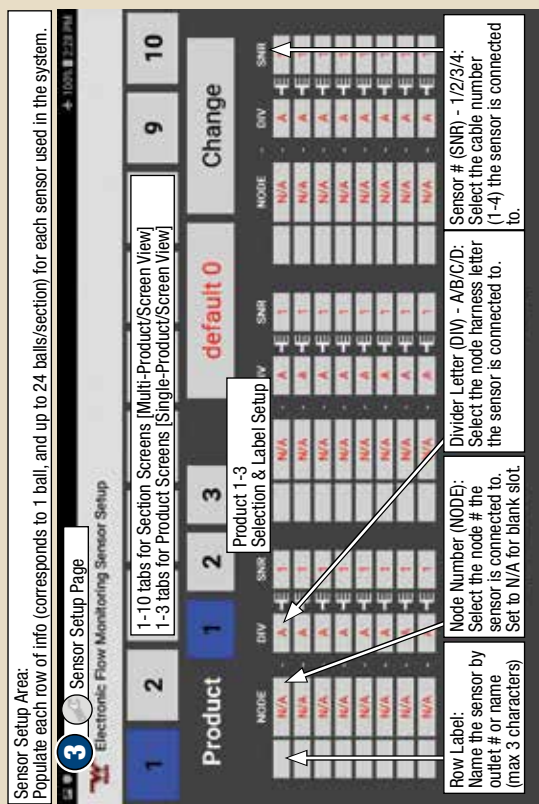
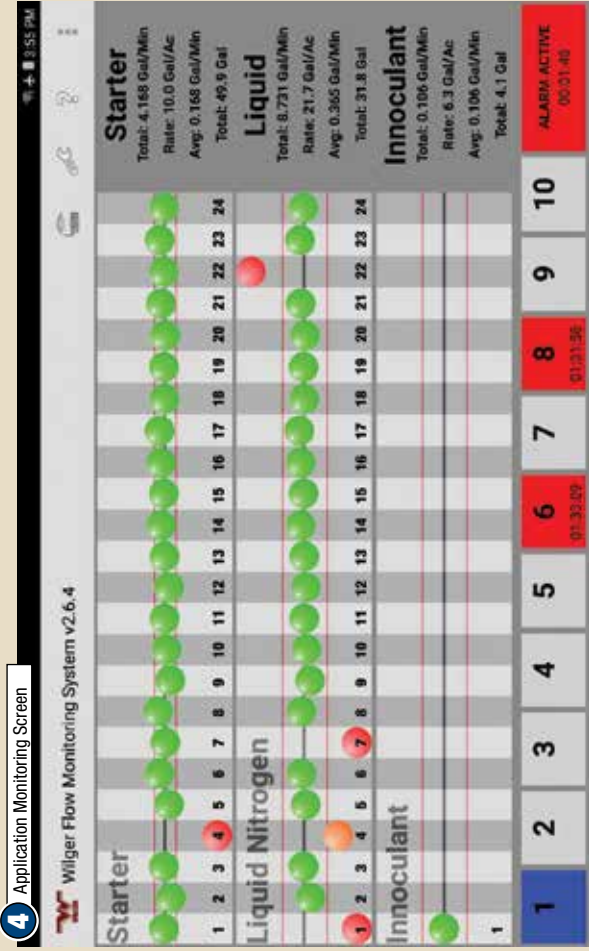

Now that basic setup is complete, explore the individual row detailed screens, application widgets, advanced calibration screen, and equipment profile saving as well.



Case IH Sprayer with AimCommand Flex
(www.caseih.com)
USA

Wilger makes spray tips for applicators who care about how they spray.



Smithco Sprayer with PinPoint II
(www.smithco.com)
USA



Pattison CONNECT Autonomous OMNI Sprayer with recirculating boom
(www.liquidsystems.net/connect)
Canada

Wilger makes nozzle bodies & components that address and support best practices being developed in the crop protection industry.

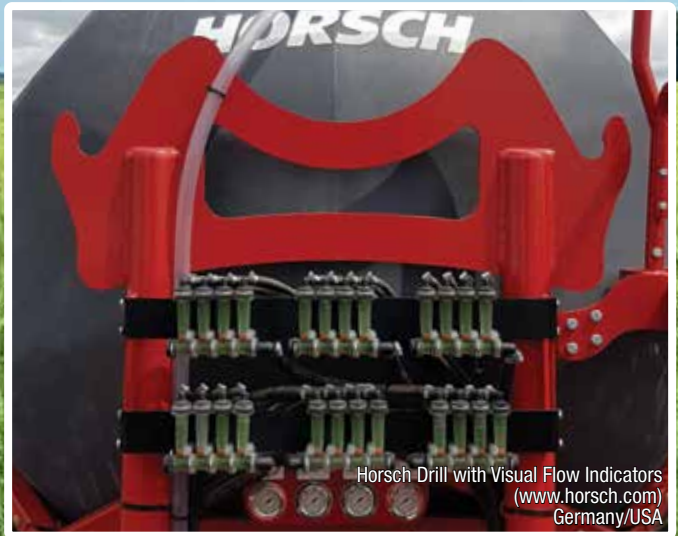

Horsch Drill with Visual Flow Indicators
(www.horsch.com)
Germany/USA



RECORD Flow Monitoring System partnered with LLC TRACK
(www.seeding.com.ua)
Ukraine

Wilger makes flow monitoring & metering components that are critical to maintaining effective and consistent application.

 **CANADA**
Wilger Industries Ltd.
Site 412, Box 280, RR#4
Capital Circle W & Auction Mart Rd.
Saskatoon, SK, Canada S7K 3J7
Phone: 1 (833) 242-4121
Fax: (306) 242-4122
Email: info@wilger.net



 **UNITED STATES**
Wilger Inc.
255 Seahorse Drive
Lexington, TN, USA
38351-6538
Phone: (877) 968-7695
Fax: (877) 968-7613
Email: WilgerEsc@WilgerEsc.com



 **ARGENTINA**
Wilger Argentina
Mitre 699
San Nicolas (2900)
Buenos Aires, Argentina
Phone: +54 9 336 4596710
Email: cjpurras@gmail.com

***Focused on Application
Performance for
Over 45 Years***
www.wilger.net

All Wilger trademarks and logos are owned by Wilger Industries Ltd. All other brand or product names are trademarks or registered marks of their respective owners. All rights reserved.

Printed in Canada