

PRICE PAGE INDEX

EFFECTIVE APRIL 11, 2011

NOTE: MANY LOADERS USE THE SAME STYLE HOOK UP, SO YOU MAY BE REFERRED TO OTHER SECTIONS.

	PAGE #
Rock Bucket Grapple Compatibility Chart	1
ROCK BUCKETS & GRAPPLES	3
ROTO-KING ROUND BALE PROCESSOR	4
8 FT SQUARE BALE STABBERS	4
DOUBLE TINE DOUBLE BALE STABBER - HYDRAULIC & MANUAL	5
SUR-GRIP BALE GRABBER	5
ADAPT-A-TACH (JD CLASSIC TACH & EURO/GLOBAL TACH)	6
BOLT ON MOUNTING KITS	6
REPLACEMENT BUCKETS & GRAPPLES	11
JOHN DEERE BUCKETS PAGE 39 - SKID STEER BUCKETS PAGE 46	
HIGH VOLUME BUCKETS & GRAPPLES	12
GREAT BEND & CASE/IH LOADER OEM REPLACEMENT GRAPPLES	12
MANURE BUCKETS & GRAPPLES	13
DOZER BLADES	13
WELD ON MOUNTING KITS	13
TINE PRICING - STABBER	17
TINE PRICING - PALLET FORK	17
TIRE GATOR	19
3 - POINT ATTACHMENTS	19
AGCO FL300, FL400 & FL500 & MF 1040,1050, 1060, 1070 & 1080 "New Style"	19
AGCO FL600 & MF 1090 "New Style" QT	20
ALLIED/BUHLER 395	20
ALLIED/BUHLER 495, 595 & 695	20
ALLIED/BUHLER 795	21
ALLIED/BUHLER 895 & 995	21
ALLIED/BUHLER 2495, 2595, 2596, 2795 & 2895	22
ALO-QUICKE Q700 & Q900 (EURO HOOK UP)	28
BUSH HOG M346, M446, M546 & M646	22
BUSH HOG 2426, 2446 & 2846	23
BUSH HOG 2346	23
BUSH HOG 3226	24
CASE IH 2000 SERIES PIN ON LOADERS	24
CASE IH L 300, IH 510 & IH 520	24
CASE IH 710 & IH 890	25
CASE IH L 400, 500, 600, 700 & 800 (EURO HOOK UP)	28
CASE IH LX720,LX730,LX740,LX750,LX760,LX770 & LX780 (EURO HOOK UP)	28
CASE IH LX 156, 162 & 172 (EURO HOOK UP)	28
CASE IH LX126, LX132, LX232, LX152 & LX252 - (UNIVERSAL SKID STEER STYLE HOOK-UP)	46
CASE IH LX 192 & NH 92 LB	26
CAT CHALLENGER ML SERIES (EURO HOOK UP)	28
DUAL 320/325 PIN ON	26
DUAL 340/345 PIN ON	27
DUAL 205,305,255,355,310,215,315,360 & 375 QUIK-TACH	27
DUAL 3100 PIN TO PIN	27
EURO HOOK UP LOADERS	28
FARMHAND F11 W/DOZER	29
FARMHAND XL 490,590, 662, 740,940,1140 & 1340	29

FARMHAND XL 945 & 1145	30
FORD NEW HOLLAND 7109,7209,7309,7210,7310 & 7410	30
FORD NEW HOLLAND 72LA, 7311,7411,7511,7312,7313,7412,7413 & 7414	31
FORD NEW HOLLAND VERSATILE BI-DIRECTIONAL 156,256,276,9030,2360V,7414V	31
FORD NH TV 140, 145 & 6070 BI-DIRECTIONAL TRACTORS (7614 & 84LB loaders)	31
FORD NH TV 140, 145 & 6070 BI-DIRECTIONAL TRACTORS (82 LB loaders)	32
GREAT BEND 330,340, 360, 440, 660,760,860,2136,2140,2144,2157 & 2166	32
JD 145 & 146 with 10" CENTERS	33
JD 145, 146, 148 & 158 with 13" CENTERS	33
JD 168	34
JD 175	35
JD 240, 245, 260 & 265	36
JD 280	36
JD 200X, 200CX, 300X, 300CX, 400, 400X, 500, 500X	37
JD 600/700 PIN ON SERIES	38
JD 563/673 WITH JD GLOBAL CARRIER QUIK-TACH	39
JD 640, 740, 741 & 746 JD CLASSIC QUIK-TACH SERIES	39
JD 840 & 843	40
JD H480 QUIK-TACH SERIES	40
JD 48/58	41
KD 5000, 6400 & 7400 PIN TO PIN	41
KOYKER LOADERS	42
KUBOTA LA39,LA513,LA723,LA853,LA1163,LA1301 & LA 1601 with UNIVERSAL SKID STEER HOOK-UP	46
KUBOTA LA1251	43
MASSEY-FERGUSON	43
MC CORMICK "L" SERIES (EURO HOOK UP)	28
MILLER M12-P12	43
MILLER PL2X, PL2 JR, PL2, GP25 & GL25	44
MILLER PL3, PL4, PL5, GL30, GP30 & GP35	44
MILLER G15 & G20	45
NEW HOLLAND LA, LB, & TL SERIES with UNIVERSAL SKID STEER STYLE HOOK-UP	46
NEW HOLLAND 56LB, 62LB, 72LB,810TL,820TL,830TL,840TL,850TL,860TL & 870TL	28
NEW HOLLAND 92LB (Case IH LX 192)	26
SKID STEER FOR 1995 & NEWER & TRACTOR LOADERS with UNIVERSAL SKID STEER STYLE HOOK-UP	46
SKID STEER FOR 1994 & OLDER NEW HOLLAND	47
SKID STEER FOR GEHL 3725 & 3825	49
SKID STEER FOR GEHL 4625, 5625 & 6625	49
SKID STEER FOR GEHL E-SERIES (UNIVERSAL SKID STEER STYLE HOOK-UP)	46
SUR-LOCK QUIK-TACH SYSTEMS	49
WESTENDORF 20	50
WESTENDORF 40	50
WESTENDORF 70	51
ZETOR (Euro Hook Up)	28
CUSTOM BUILT PRODUCT	51
TELEHANDLER	53
WHEEL LOADERS	55
TELEHANDLER/WHEEL LOADER HOOKUP ILLUSTRATION SHEET	56
OIL TANK PRICING	57
DISCOUNT SCHEDULE	59

BOLT ON mounts need to be ordered for ROCK BUCKETS, ROTO-KINGS, 8 FT SQUARE BALE STABBERS, DOUBLE TINE DOUBLE BALE STABBERS, SUR-GRIP BALE GRABBERS & ADAPT-A-TACH SYSTEMS. Part numbers start on Page 6. **NOTE**: Some applications require **WELD ON** mounts

ROCK BUCKET PRICING

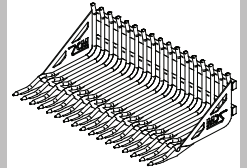

BOLT ON MOUNT KITS SOLD SEPARATELY

PART NO	WIDTH	TINE DIAMETER	TINE SPACING	NUMBER OF TINES	LENGTH	HEIGHT	WT	LIST PRICES
LRB418	4'	1 1/8"	1 3/4"	17	39"	26"	570	\$1,540.00
LRB518	5'	1 1/8"	1 3/4"	21	39"	26"	680	\$1,750.00
LRB618	6'	1 1/8"	1 3/4"	25	39"	26"	795	\$1,962.00
LRB718	7'	1 1/8"	1 3/4"	30	39"	26"	940	\$2,217.00

MRB514	5'	1 1/4"	2 1/2"	16	42"	26"	675	\$2,083.00
MRB614	6'	1 1/4"	2 1/2"	20	42"	26"	790	\$2,261.00
MRB714	7'	1 1/4"	2 1/2"	23	42"	26"	900	\$2,395.00
MRB814	8'	1 1/4"	2 1/2"	25	42"	26"	1015	\$2,639.00

HRB512	5'	1 1/2"	3"	14	42"	26"	735	\$2,690.00
HRB612	6'	1 1/2"	3"	17	42"	26"	830	\$2,795.00
HRB712	7'	1 1/2"	3"	19	42"	26"	970	\$2,898.00
HRB812	8'	1 1/2"	3"	22	42"	26"	1155	\$3,216.00
HRB912	9'	1 1/2"	3"	24	42"	26"	1250	\$3,716.00

RB-SSP	OPTIONAL - 5/8" Thick Serrated Side Plates (logging application) for Above Rock buckets						N/A	\$195.00
--------	--	--	--	--	--	--	-----	----------

WELD ON MOUNTS ONLY FOR XRB BUCKETS - SEE PAGE 13

XRB734	7'	1 3/4"	4"	15	45"	39"	1475	\$5,712.00
XRB834	8'	1 3/4"	4"	17	45"	39"	1590	\$6,032.00
XRB934	9'	1 3/4"	4"	19	45"	39"	1890	\$6,350.00
XRB1034	10'	1 3/4"	4"	21	45"	39"	2070	\$6,752.00

Due to **Standardized** tine Spacing - **ACTUAL** bucket widths may vary

GRAPPLE FORK

Part #	Description	WT*	LIST PRICE
GF-4	4-Tine Quik-Tach Grapple Fork with Cylinders and Hydraulic Package for LRB, MRB & HRB buckets	450	\$ 2,150.00
GFT-58	Bolt On Grapple Fork Tine With Hardware for above grapple (5/8" Base Plate)	20	\$ 150.00
GF-XRB4	4-TINE Quik-Tach Grapple Fork with Cylinders and Hydraulic Package for XRB buckets	1250	\$ 5,995.00

GF-XRB5	5-TINE Quik-Tach Grapple Fork with Cylinders and Hydraulic Package for XRB buckets	1300	\$ 6,305.00
GFT-XRB100	Bolt IN XRB Grapple Fork Tine (1" thick T1 Steel)	32	\$ 214.00

ROTO-KING ROUND BALE PROCESSOR



BOLT ON MOUNT KITS SOLD SEPARATELY
WELD ON MOUNTS ARE NOT AVAILABLE FOR ROTO-KINGS

RK-500	ROTO-KING Bale Processor - Complete with Rotor Knives, Hydraulic Drive, Bale Loading Stabbers and Spill Guards. <u>6 ft Bale Width x 6 ft Bale Diameter</u> (LESS MOUNTING KIT)	1085	\$7,316.00
RK-350	ROTO-KING Bale Processor - Complete with Rotor Knives, Hydraulic Drive, Bale Loading Stabbers and Spill Guards. <u>48" Bale Width x 66" Bale Diameter</u> (LESS MOUNTING KIT)	825	\$6,810.00
RK-252	25 FT HOSE KIT. (3/4" Hydraulic hose) REQUIRED ON FARM DUTY TRACTORS WITH LESS THAN 12 GPM OIL FLOW AT LOADER'S 3RD FUNCTION GRAPPLE PORTS. ALL COUPLERS INCLUDED	32	\$539.00
RK-BSP-5	Optional Bolt On Front Runner Wear Kit for RK-500	32	\$120.00
RK-BSP-3	Optional Bolt On Front Runner Wear Kit for RK-350	28	\$108.00
RK-3PT	3-PT BOLT ON Mounting Kit for Roto-Kings INCLUDES Cylinder, Hoses w/Pioneer ends & U-Bolts	450	\$1,620.00

8 FT SQUARE BALE STABBERS

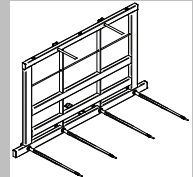

BOLT ON MOUNT KITS SOLD SEPARATELY

PART #	DESCRIPTION	WT	BALE SIZE	BALE CAP.	LIST PRICE
M3C133	MANUAL SINGLE BALE CAPACITY 60" WIDE - 24" HIGH WITH (3) 1 3/8" x 39" TINES - WELD ON MOUNTS ONLY - SEE PAGE 13	375	3 X 3	1	\$ 785.00
M3C243	MANUAL SINGLE BALE CAPACITY 60" WIDE - 24" HIGH WITH (3) 1 3/4" x 48" TINES - WELD ON MOUNTS ONLY - SEE PAGE 13	375	4 X 4	1	\$ 1,061.00
MC133	MANUAL 4-TINE SQUARE BALE STABBER 72" WIDE - 54" HIGH WITH - 1 3/8" x 39" TINES	425 - 575	3 X 3	2	\$ 1,328.00
MC133E	MANUAL 4-TINE SQUARE BALE STABBER 72" WIDE - 54" HIGH WITH - 1 3/8" x 39" TINES 24" BULKHEAD EXTENSION	565 - 715	3 X 3	3	\$ 1,683.00
MC233E	MANUAL 4-TINE SQUARE BALE STABBER 72" WIDE - 54" HIGH WITH - 1 3/4" x 39" TINES 24" BULKHEAD EXTENSION (THIS UNIT IS RECOMMENDED FOR TELEHANDLERS & WHEEL LOADERS)	875-925	3 X 3	3	\$ 1,906.00
MC243	MANUAL 4-TINE SQUARE BALE STABBER 72" WIDE - 54" HIGH WITH - 1 3/4" x 48" TINES	875-925	3 x 4	2	\$1,683.00

MC243E	MANUAL 4-TINE SQUARE BALE STABBER 72" WIDE - 54" HIGH WITH - 1 3/4" x 48" TINES 24" BULKHEAD EXTENSION (THIS UNIT IS RECOMMENDED FOR TELEHANDLERS & WHEEL LOADERS)	875-925	4 X 4 3 x 4	2 3	\$ 2,039.00
HC133	HYDRAULIC PUSH-OFF 4-TINE SQUARE BALE STABBER Unit is 72" WIDE - 54" HIGH with 1 3/8" x 39" TINES	685 - 735	3 X 3	2	\$ 2,333.00
HC133E	HYDRAULIC PUSH-OFF 4-TINE SQUARE BALE STABBER Unit is 72" WIDE - 54" HIGH with 1 3/8" x 39" TINES & 24" BULKHEAD EXTENSION	825 - 875	3 X 3	3	\$ 2,689.00
HC233E	HYDRAULIC PUSH-OFF 4-TINE SQUARE BALE STABBER 72" WIDE - 54" HIGH WITH - 1 3/4" x 39" TINES 24" BULKHEAD EXTENSION (THIS UNIT IS RECOMMENDED FOR TELEHANDLERS & WHEEL LOADERS)	875-925	3 X 3	3	\$ 2,889.00
HC243	HYDRAULIC PUSH-OFF 4-TINE SQUARE BALE STABBER Unit is 72" WIDE - 54" HIGH with 1 3/4" x 48" TINES	875 - 925	3 x 4	2	\$ 2,739.00
HC243E	HYDRAULIC PUSH-OFF 4-TINE SQUARE BALE STABBER Unit is 72" WIDE - 54" HIGH with 1 3/4" x 48" TINES & 24" BULKHEAD EXTENSION (THIS UNIT IS RECOMMENDED FOR TELEHANDLERS & WHEEL LOADERS)	875 - 925	4 X 4 3 x 4	2 3	\$ 3,098.00
ACCESSORIES					
AC243	1 3/4" X 48" STABBER TINE FOR HANDLING (1) ROUND BALE	40		1	\$ 328.00
AC24B	24" BULKHEAD EXTENSION	140			\$ 361.00

DOUBLE TINE DOUBLE BALE STABBER
(HYDRAULIC SIDE SHIFT & MANUAL UNITS)
BOLT ON MOUNT KITS SOLD SEPARATELY
2 BALE CAPACITY

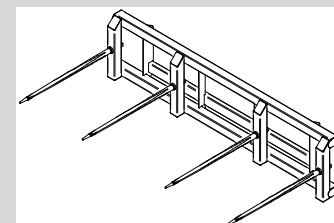

Part #	Description	WT*	LIST PRICE
HDDBS-04	Hydraulic Double Tine Double Bale Stabber - Hydraulic Side Shift (Up to 12") BOLT-ON mounts required	680	\$ 2,233.00
MDDBS-04	Manual Double Tine Double Bale Stabber - Fixed Frame - Bolt-On Mounts Required *3-pt mount units available in Weld-ON version - see page 19	489	\$ 1,576.00

SUR-GRIP BALE GRABBER
BOLT ON MOUNT KITS SOLD SEPARATELY

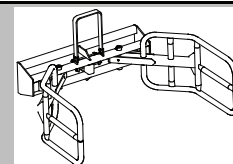

Part #	Description	WT	LIST PRICE
SG-4	SUR-GRIP Bale Grabber with Hydraulic Cylinders with arms for 4 - 5 ft bales (Short Arms)	551	\$ 1,544.00
SG-6	SUR-GRIP Bale Grabber with Hydraulic Cylinders with arms for 5 - 6 ft bales (Long Arms)	650	\$ 1,628.00

ADAPT - A - TACH SYSTEMS

JOHN DEERE CLASSIC TACH (picks up JD attachments)

Part #	Frame #	2 pieces required for complete unit(1 FRAME and 1 BOLT-ON mount). To determind which frame is needed, refer to the "FRAME #" listed next to the desired loader model under the BOLT-ON Mounting Kit section	WT	LIST PRICE
5528	na	JOHN DEERE CLASSIC TACH w/WELD ON UNIVERSAL SKID STEER HOOK-UP	197	\$ 856.00
5228	na	JOHN DEERE CLASSIC TACH w/WELD ON EURO-GLOBAL HOOK-UP	191	\$ 992.00
1028-50	1	JOHN DEERE CLASSIC TACH (MALE SIDE) - 50" frame - Bolt-On Mounts Required	151	\$ 585.00
1028-61	2	JOHN DEERE CLASSIC TACH (MALE SIDE) - 61" frame -Bolt-On Mounts Required	161	\$ 614.00
1028-78	3	JOHN DEERE CLASSIC TACH (MALE SIDE) - 78" frame -Bolt-On Mounts Required	171	\$ 656.00

EURO/GLOBAL TACH (picks up Euro/Global attachments)

Part #	Frame #	2 pieces required for complete unit (1 FRAME and 1 BOLT-ON mount). To determind which frame is needed, refer to the "FRAME #" listed next to the desired loader model under the BOLT-ON Mounting Kit section	WT	LIST PRICE
2852	na	EURO-GLOBAL TACH w/WELD ON JD CLASSIC QUIK-TACH	267	\$1,282.00
5552	na	EURO-GLOBAL TACH w/WELD ON UNIVERSAL SKID STEER HOOK-UP	221	\$ 1,027.00
1052-50	1	EURO-GLOBAL TACH (MALE SIDE) - 50" frame -Bolt-On Mounts Required	175	\$ 805.00
1052-61	2	EURO-GLOBAL TACH (MALE SIDE) - 61" frame -Bolt-On Mounts Required	185	\$ 861.00
1052-78	3	EURO-GLOBAL TACH (MALE SIDE) - 78" frame -Bolt-On Mounts Required	195	\$ 916.00

NOTE:Uni-Tach Skid Steer Attachment Carriers are listed under individual loader models.

BOLT ON mounting kits for Rock Buckets , Roto-King Bale Processors , 8 FT Square Bale Stabbers , Hydraulic & Manual Dble Bale Stabbers , Adapt-A-Tach Systems , Sur-Grip Bale Grabbers

Note: Some applications require WELD ON mounts

ALL Pin to Pin Loaders Require a Schematic Drawing

Part #	Adapt-A-Tach Frame #	Description	WT	LIST PRICE
5720	n/a	3 -Point BOLT ON Mounting Kit	195	\$748.00

5620	2	Agco FL300, FL400 & FL500 & MF 1040, 1050, 1060, 1070 & 1080 "New Style" BOLT ON Mounting Kit - 2 pc	151	\$416.00
6820	3	Agco FL 600 & MF 1090 "New Style" BOLT ON Mounting Kit - 2 pc	151	\$416.00
7820	2	Allied/Buhler 395 QT BOLT ON Mounting Kit - 2 pc	211	\$416.00
4620	2	Allied/Buhler 495, 595, & 695 QT BOLT ON Mounting Kit - 2 pc	211	\$416.00
5820	2	Allied/Buhler 795 QT BOLT ON Mounting Kit - 2 pc	211	\$416.00
4720	3	Allied/Buhler 895 & 995 QT BOLT ON Mounting Kit - 2 pc	226	\$416.00
4820	2	Allied/Buhler 2495, 2595, 2596, 2795 & 2895 Quik-Tach Series BOLT ON Mounting Kit - 2 pc	146	\$416.00
		Alo-Quicke Q700/Q900 BOLT ON Mounting Kit - See EURO HOOK UP		
6020		Bush Hog M346, M446, M546 & M646 QT Series BOLT ON Mounting Kit - 2 pc	181	\$475.00
6120	2	Bush Hog 2426, 2446 & 2846 Quik-Tach Series BOLT ON Mounting Kit - 2 pc	181	\$475.00
7520	2	Bush Hog 3226 Quik-Tach Series BOLT ON Mounting Kit - 2 pc		\$475.00
7620		Bush Hog 2346 Quik-Tach Series BOLT ON Mounting Kit - 2 pc		\$475.00
3120	2	Case IH 2000 Series Pin On Loaders BOLT ON Mounting Kit - 2 pc	186	\$416.00
3220	2	Case IH L300, IH 510 & IH 520 Quik-Tach Loaders BOLT ON Mounting Kit - 1 pc	221	\$533.00
11820	3	Case IH 710 & 890 Quik-Tach Loaders BOLT ON Mounting Kit	191	\$586.00
		Case IH L 400, 500, 600, 700, & 800 Quik-Tach Series (includes 05, 50 & 55 series) Loaders BOLT ON Mounting Kit - 2 pc - see EURO HOOK UP		
		Case IH LX 156, 162, & 172 Series Loaders Bolt on Mounting Kit - see EURO HOOK UP		
		CASE IH LX126, LX132, LX232, LX152 & LX252 - (UNIVERSAL SKID STEER STYLE HOOK-UP)		
		Case IH LX720, LX730, LX740, LX750, LX770 & LX780 - see EURO HOOK UP		
9120	3	Case IH LX 192 & New Holland 92 LB Series Loaders BOLT ON Mounting Kit - 2 pc	195	\$573.00
		Cat Challenger ML 72, 75, 77, 92, 94, 96, 97, 98 & 99 Series Loaders Mounting Kit - 2 pc. - see EURO HOOK UP		
4120	3	Dual 340/345 Pin to Pin Series Loaders BOLT ON Mounting Kit - 2 pc	176	\$416.00
6620	3	Dual 300/325 Pin to Pin Series Loaders BOLT ON Mounting Kit - 2 pc	176	\$416.00
4220	3	Dual 205, 305, 255, 355, 310, 215, 315, 260, 360, 275 & 375 QT Loaders BOLT ON Mounting Kit	251	\$533.00
11920	3	Dual 3100 Pin to Pin Loader BOLT ON Mounting Kit	146	\$450.00
5220	2	EURO HOOK UP - Agco 340, Alo-Quicke 700 & 900 series, Case IH L400, L500, L600, L700, L800 series, LX156, LX162, LX172, LX720, LX730, LX 740, LX760, LX770 & LX780, Cat Challenger ML series, Fendt Loaders, JD 563 & 673 with GLOBAL CARRIER, KMW 1440, 1660, 1750, 1760 & 1860, Koyker 1585 & 2585, MF 950, 955, 960, 965, 975 & 985, McCormick L series, NH 56LB, 62LB, 72LB, 810TL, 820TL, 830TL, 840TL, 850TL, 860TL & 870TL, STOLL, ZETOR 90, 92, 92HL, 100, 101, 101SL, 102, 102HL, 102SLX, 112SLX, 202, 202SL, 202SLX & 302 BOLT ON Mounting Kit	125	\$406.00
4920	2	Farmhand F11 Quik-Tach Series Includes 235, 236, 248, 258 & 358 BOLT ON Mounting Kit - 1 pc	220	\$503.00
5020	2	Farmhand XL 590, 662, 740, 940, 1140 & 1340 Quik-Tach BOLT ON Mounting Kit - 2 pc	171	\$416.00
5120	2	Farmhand XL 945 & 1145 Quik-Tach BOLT ON Mounting Kit - 2 pc	166	\$416.00
3420	2	Ford New Holland 7109, 7209, 7309, 7210, 7310, & 7410 QT Loaders BOLT ON Mounting Kit - 1 pc	210	\$533.00
3520	3	Ford New Holland 72 LA, 7311, 7411, 7511, 7312, 7412, 7313, 7413, & 7414 QT Loaders BOLT ON Mounting Kit - 1 pc	231	\$533.00
3820	3	Ford New Holland/Versatile Bi-Directional Loaders 156, 256, 276, 9030, 2360V, 7414V BOLT ON Mounting Kit - 2 pc	186	\$478.00
3720	3	Ford New Holland TV 140, 145 & 6070 Bi-Directional Tractors with Model 7614 or Model 84LB Loaders BOLT ON Mounting Kit - 2 pc	226	\$478.00
5320	3	Ford New Holland TV 140, 145 & 6070 Bi-Directional Tractors with Model 82LB Loaders BOLT ON Mounting Kit - 2 pc	156	\$478.00
3920	1	Great Bend 360, 460, 660, 760, 860, 2136, 2140, 2144, 2157 & 2166 QT Series Loaders BOLT ON Mounting Kit - 1 pc	226	\$533.00

12020	1	JD 145 & 146 with 10" center BOLT ON Mounting Kit - 2 pc	181	\$416.00
2120	1	JD 145,146,148 & 158 with 13" center or MDS Quik-Tach BOLT ON Mounting Kit - 2 pc	181	\$416.00
9320	2	JD 168 BOLT ON Mounting Kit - 2 pc	181	\$416.00
2220	2	JD 175 Pin On Loaders BOLT ON Mounting Kit -2 pc	181	\$416.00
2320	1	JD 240, 245, 260 & 265 Quik-Tach Series Loaders BOLT ON Mounting Kit - 1 pc	181	\$533.00
2420	2	JD 280 QT BOLT ON Mounting Kit - 1 pc	146	\$533.00
2620	1	JD 200X, 200CX, 300X, 300CX, 400, 400X, 500 & 500X QT BOLT ON Mounting Kit - 2 pc	125	\$416.00
2720	2	JD 600/700 Pin On Series BOLT ON Mounting Kit - 2 pc	130	\$416.00
		JD 563/673 with Global Carrier Quik-Tach BOLT ON Mounting Kit - see EURO HOOK UP		
2820	2	JD 600/700 Quik-Tach (Classic) Series BOLT ON Mounting Kit - 2 pc	176	\$528.00
12520	3	JD H480 Quik-Tach BOLT ON Mounting Kit	225	\$825.00
2920	3	John Deere 840 & 843 QT BOLT ON Mounting Kit - 2 pc	190	\$573.00
3020	1	JD 48/58 Single Cylinder Loaders BOLT ON Mounting Kit - 1 pc	251	\$533.00
11220	2	KD 5000, 5500, 6400 & 7400 loaders with 1 3/8" pins 13" on center BOLT ON Mounting Kit	146	\$416.00
11120	1	Koyker 180, 185, 190, 195, 210, 220, 235 & 245 Koyker QT System BOLT ON Mounting Kit	146	\$533.00
11020	2	Koyker 310, 345, 385, 445, 510, 545, 565, 585, 600 & 645 Koyker QT System BOLT ON Mounting Kit	240	\$533.00
		Kubota LA39, LA513, LA723, LA853, LA1163, LA1301 & LA1601 Loaders with Universal Skid Steer Hook-up - see SKID STEER w/Universal Hook up		
9020	2	Kubota LA1251 Quik-Tach Loaders BOLT ON Mounting Kit - 2 pc	260	\$473.00
		Massey-Ferguson 1040, 1050, 1060, 1070 & 1080 New Style BOLT ON Mounting Kit - see AGCO FL300 HOOK UP		
		Massey-Ferguson 1090 "New Style" BOLT ON Mounting Kit - see AGCO FL600 HOOK UP		
		McCormick "L" Series Quik-Tach Series Loaders - 2 pc - see EURO HOOK UP		
5420	1	Miller M12-P12 Quik-Tach Loader BOLT ON Mounting Kit - 1 pc	191	\$743.00
6520	2	Miller PL2X, PL2 JR, PL2, GP25 & GL25 Quik-Tach BOLT ON Mounting Kit-1 pc	191	\$743.00
6920	2	Miller PL3, PL4, PL5, GL30, GP30, & GP 35 Quik-Tach Loader BOLT ON Mounting Kit - 1 pc	191	\$743.00
9720	2	Miller G15 & G20 Quik-Tach BOLT ON Mounting Kit - 1 pc	191	\$743.00
		New Holland 32LA, 33LA, & 52LA Series & 46LB & 52LB Series with Universal Skid Steer Hook-up BOLT ON Mounting Kit -see SKID STEER w/Universal Hook up		
		New Holland 56LB, 62LB & 72LB Loaders BOLT ON Mounting Kit -see EURO HOOK UP		
		New Holland 92 LB BOLT ON Mounting Kit - see Case IH LX 192 HOOK UP		
5520	1	Skid Steer for 1995 and Newer with Universal Skid Steer Hook-up BOLT ON Mounting Kit - 1 pc	150	\$416.00
5520-4	1	Skid Steer for 1995 and Newer with Universal Skid Steer Hook-up WELD ON Mounting Kit - ROCK BUCKETS ONLY - 1/4" plate	68	\$211.00
7120	1	Skid Steer Dog Ear Hook-up (NH L553-L554-L555-L775-L779-L781-L783-L784-L785-L865 BOLT ON Mounting Kit (43" Wide Hook-up) 1 pc	186	\$595.00
7220	1	Skid Steer Dog Ear Hook-up (NH L35-L424-L425-L445-L451-L452-L454-L455 BOLT ON Mounting Kit (30 3/4" Wide Hook-up) 1 pc	176	\$551.00
8320	1	Gehl 3725 & 3825 Quik-Tach BOLT ON Mounting Kit - 2 pc	136	\$500.00
8420	1	Gehl 4625, 5625 & 6625 Series Quik-Tach BOLT ON Mounting Kit - 2 pc	136	\$500.00
4320	2	Westendorf 20 Series Loader BOLT ON Mounting Kit - 2 pc	176	\$416.00
4420	2	Westendorf 40 Series Loader BOLT ON Mounting Kit - 2 pc	176	\$416.00
4520	3	Westendorf 70 Series Loader BOLT ON Mounting Kit - 2 pc	176	\$416.00
		Zetor 90, 92, 92HL, 100, 101, 101SL, 102, 102HL, 102SLX, 112SLX, 202, 202SL, 202SLX & 302 - see EURO HOOK UP		

TELEHANDLER LOADER MOUNTING KITS

11720	n/a	Bobcat Versahandler 518 & 723 Telehandler Series BOLT ON Mounting Kit	350	\$ 1,383.00
12620	n/a	CAT TH 62-82-83 Series Telehandler BOLT ON Mounting kit	388	\$ 1,375.00
12720	n/a	Gehl AL700 Series Telehandler BOLT ON Mounting Kit	224	\$ 1,295.00
12820	n/a	Gehl Dynattach (Narrow - 11.5" inside measurement) - RS6 Telehandler BOLT ON Mounting Kit	242	\$ 874.00
12920	n/a	Gehl Dynattach (Wide - 13" inside measurement) - RS5 Telehandler BOLT ON Mounting Kit	247	\$ 909.00
13020	n/a	Gradall 534D Telehandler BOLT ON Mounting Kit	243	\$ 1,185.00
13120	n/a	Ingersoll-Rand telehandler BOLT ON Mounting Kit	245	\$ 1,285.00
13220	n/a	JCB 506C Series Telehandler BOLT ON Mounting Kit	277	\$ 1,064.00
9520	n/a	JCB 520 Series Telehandler BOLT ON Mounting Kit	253	\$ 1,094.00
7420	n/a	JCB 530-540/NH LM 430 (yellow) Telehandler "Q-Fit" Series BOLT ON Mounting Kit	281	\$ 1,219.00
9420	n/a	JD 3200/3400/3800 Telehandler Series BOLT ON Mounting Kit	270	\$ 1,060.00
13320	n/a	JLG Telehandler BOLT ON Mounting Kit	366	\$ 1,219.00
13420	n/a	Lull Telehandler BOLT ON Mounting Kit	252	\$ 1,069.00
11520	n/a	Manitou, NH LM 435 (blue) & Gehl CT618 & CT723 Mounting Kit BOLT ON Mounting Kit	185	\$ 1,083.00
13520	n/a	NH M428, M427, M459 Telehandler BOLT ON Mounting Kit	293	\$ 1,199.00

WHEEL LOADER MOUNTING KITS

12420	n/a	CAT IT Series 14-24-28/CAT 924 & 930G/CAT 406TH BOLT ON Mounting kit	321	\$ 1,403.00
13620	n/a	CWS Canadian Coupler Wheel Loader BOLT ON Mounting Kit	355	\$ 1,962.00
13720	n/a	Gehl AWS 36, Gehl 480, 480T, ML36 Series Wheel Loader BOLT ON Mounting Kit	311	\$ 1,342.00
13820	n/a	Gehl AWS 46, Gehl 680, ML46 Series Wheel Loader BOLT ON Mounting Kit	326	\$ 1,402.00
12120	n/a	JD 244J, JCB 409B, Komatsu WA95, Volvo L35 Compact Wheel Loader BOLT ON Mounting Kit (ALL attachment except 4-tine)	210	\$ 613.00
12120-SQ	n/a	JD 244J, JCB 409B, Komatsu WA95, Volvo L35 Compact Wheel Loader BOLT ON Mounting Kit (for square bale stabber ONLY)	284	\$ 953.00
12220	n/a	JRB 500 Series QT (includes JD444/544, Case 521/621, Komatsu WA 200/320, NH LW170) BOLT ON Mounting Kit	340	\$ 1,628.00
14020	n/a	JRB 600 Series QT (includes JD644, Komatsu WA380) BOLT ON Mounting Kit	470	\$ 1,953.00
12320	n/a	Volvo Wheel Loader L-Series (L50-60-70-80-90-110-120) , JCB 416 & 426 BOLT ON Mounting Kit	310	\$ 1,403.00

****DUE TO VARIATIONS IN TELEHANDLER/WHEEL LOADER MODEL NUMBER & HOOKUP TYPES, VERIFICATION OF PART NUMBER IS NECESSARY BEFORE ORDERING****

This page intentionally left blank

***WELD ON* mounts need to be added to
REPLACEMENT/HIGH VOLUME BUCKETS, MANURE
 BUCKETS & DOZER BLADES**

WELD ON PART NUMBERS START ON PAGES 13.

****See page 39 for John Deere Replacement Buckets****

**** See page 46 for Skid Steer Buckets ****

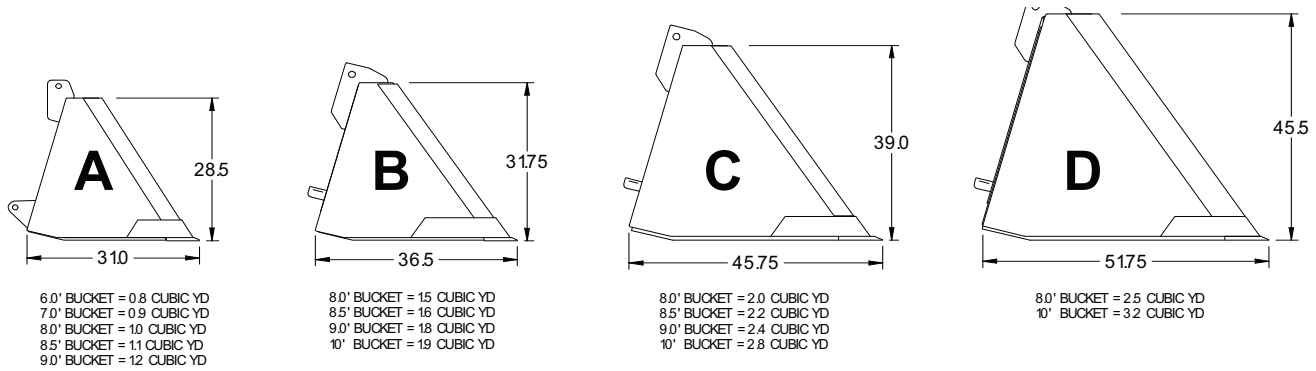

LISTED CUBIC YARDAGE IS STRUCK CAPACITY

BUCKETS

REPLACEMENT BUCKETS

WELD ON MOUNT KITS ORDERED SEPARATELY- page 13

OPTIONAL 5/8" x 6" DOUBLE BEVEL REVERSIBLE BOLT ON CUTTING EDGES

PART #	DESCRIPTION	WT	LIST PRICE
60-080	6 Ft Replacement Bucket (.8 cubic yd) REF: Profile A	393	\$ 1,160.00
70-090	7 Ft Replacement Bucket (.9 cubic yd) REF: Profile A	546	\$ 1,312.00
80-100	8 Ft Replacement Bucket (1.0 cubic yd) REF: Profile A	699	\$ 1,660.00
85-110	8.5 Ft Replacement Bucket (1.1 cubic yd) REF: Profile A	776	\$ 1,928.00
90-120	9 Ft Replacement Bucket (1.2 cubic yd) REF: Profile A	852	\$ 2,176.00
LL-1	Optional ADD ON Lifting Lug with clevis & pear ring for above buckets	12	\$ 88.00

OPTIONAL 5/8" x 6" DOUBLE BEVEL REVERSIBLE BOLT ON CUTTING EDGES

PART #	DESCRIPTION	WT*	LIST PRICE
DBF-586-72	5/8" x 6" x 6 Ft Double Bevel Reversible Bolt on Cutting Edge	76	\$ 200.00
DBF-586-84	5/8" x 6" x 7 Ft Double Bevel Reversible Bolt on Cutting Edge	89	\$ 200.00
DBF-586-96	5/8" x 6" x 8 Ft Double Bevel Reversible Bolt on Cutting Edge	97	\$ 225.00
DBF-586-102	5/8" x 6" x 8.5 Ft Double Bevel Reversible Bolt on Cutting Edge	101	\$ 315.00
DBF-586-108	5/8" x 6" x 9 Ft Double Bevel Reversible Bolt on Cutting Edge	105	\$ 342.00

REPLACEMENT BUCKET GRAPPLES

PART #	DESCRIPTION	WT	LIST PRICE
GF52-4B	4-TINE GRAPPLE FOR Part # 60-080, 70-090, 80-100, 85-110 & 90-120 Replacement BUCKET	548	\$ 2,075.00
GF52-5B	5-TINE GRAPPLE FOR Part # 60-080, 70-090, 80-100, 85-110 & 90-120 Replacement BUCKET	575	\$ 2,375.00
GFT-75	5/8" T-1 Bolt on Tine w/th 3/4" base plate & U-Bolts	33	\$ 181.00
120-0484	Wide Stance Weld-On Grapple Components (4 upper/4 lower)	35	\$ 95.00

HIGH VOLUME BUCKETS

WELD ON MOUNT KITS ORDERED SEPARATELY - page 13
 OPTIONAL 3/4" x 8" DOUBLE BEVEL REVERSIBLE BOLT ON CUTTING EDGES

PART #	DESCRIPTION	WT	LIST PRICE
80-150	8 FT High Volume Bucket (1.5 cubic yd) ** {5/8" X 6" cutting edge see above} Ref: Profile B	997	\$ 2,447.00
85-165	8.5 FT High Volume Bucket (1.6 cubic yd) REF: Profile B	1132	\$ 2,723.00
90-180	9 Ft High Volume Bucket (1.8 cubic yd) REF: Profile B	1177	\$ 2,965.00
10-190	10 Ft High Volume Bucket (1.9 cubic yd) REF: Profile B	1267	\$ 3,441.00
80-200	8 Ft High Volume Bucket (2.0 cubic yd) REF: Profile C	1356	\$ 2,756.00
85-220	8.5 Ft High Volume Bucket (2.2 cubic yd) REF: Profile C	1423	\$ 3,055.00
90-240	9 Ft High Volume Bucket (2.4 cubic yd) REF: Profile C	1490	\$ 3,354.00
10-280	10 Ft High Volume Bucket (2.8 cubic yd) REF: Profile C	1624	\$ 3,995.00
80-250	8 Ft High Volume Bucket (2.5 cubic yd) REF: Profile D	1899	\$ 4,232.00
10-320	10 Ft High Volume Bucket (3.2 cubic yd) REF: Profile D	2237	\$ 5,617.00
80-350	8 Ft High Volume Bucket (3.5 cubic yd) (grapple not available)	2030	\$ 5,244.00
80-400	8 Ft High Volume Bucket (4.0 cubic yd) (grapple not available)	2170	\$ 5,960.00

OPTIONAL 3/4" x 8" DOUBLE BEVEL REVERSIBLE BOLT ON CUTTING EDGES

DBF-348-96	3/4" X 8" X 8 Ft Double Bevel Reversible Bolt on Cutting Edge	150	\$ 407.00
DBF-348-102	3/4" X 8" X 8.5 Ft Double Bevel Reversible Bolt on Cutting Edge	160	\$ 439.00
DBF-348-108	3/4" X 8" X 9 Ft Double Bevel Reversible Bolt on Cutting Edge	169	\$ 472.00
DBF-348-120	3/4" X 8" X 10 Ft Double Bevel Reversible Bolt on Cutting Edge	188	\$ 594.00

HIGH VOLUME BUCKET GRAPPLES

PART #	DESCRIPTION	WT	LIST PRICE
GFHV-150-4	4-TINE GRAPPLE FOR Part # 80-150, 85-165 ,90-180 OR 10-190 HIGH VOLUME BUCKET	852	\$ 3,262.00
GFHV-150-5	5-TINE GRAPPLE FOR Part # 80-150, 85-165 , 90-180 OR 10-190 HIGH VOLUME BUCKET	872	\$ 3,606.00
GFHV-200-4	4-TINE GRAPPLE FOR Part # 80-200, 85-220, 90-240, 10-280 HIGH VOLUME BUCKET	878	\$ 3,440.00
GFHV-200-5	5-TINE GRAPPLE FOR Part # 80-200, 85-220, 90-240, 10-280 HIGH VOLUME BUCKET	915	\$ 3,772.00
GFHV-250-4	4-TINE GRAPPLE FOR Part # 80-250 OR 10-320 HIGH VOLUME BUCKET	960	\$ 3,805.00
GFHV-250-5	5-TINE GRAPPLE FOR Part # 80-250 OR 10-320 HIGH VOLUME BUCKET	997	\$ 4,217.00
GFT-85	3/4" Bolt IN Tine for High Volume bucket GRAPPLE	25	\$ 138.00

GREAT BEND & CASE/IH LOADER OEM REPLACEMENT GRAPPLES

These grapples fit the following loader models only: GB 330, 340, 360, 440, 660, 760, 860, 2136, 2140, 2144, 2157, 2166 - CASE/IH 510, 520, L300 - CASE/IH LX SERIES LX156, LX162, LX162, LX172, LX720, LX730, LX740, LX760, LX770, LX780

PART #	DESCRIPTION	WT	LIST PRICE
GBL-524B	4-TINE GRAPPLE for GREAT BEND & CASE/IH OEM BUCKETS LISTED ABOVE	525	\$ 2,195.00
GBL-525B	5-TINE GRAPPLE for GREAT BEND & CASE/IH OEM BUCKETS LISTED ABOVE	545	\$ 2,355.00

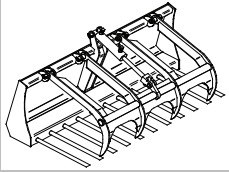

MANURE BUCKET GRAPPLES

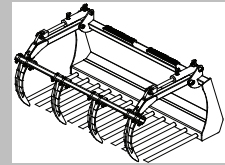

WELD ON MOUNT KITS ORDERED SEPARATELY - page 13

GRAPPLES SOLD SEPARATELY

PART #	DESCRIPTION	WT	LIST PRICE
MB114-60	60" 1 1/4" TINE STYLE MANURE BUCKET (75 HP MAX)	439	\$ 1,422.00
MB114-66	66" 1 1/4" TINE STYLE MANURE BUCKET (75 HP MAX)	469	\$ 1,545.00
MB114-72	72" 1 1/4" TINE STYLE MANURE BUCKET (75 HP MAX)	499	\$ 1,716.00
MB114-78	78" 1 1/4" TINE STYLE MANURE BUCKET (75 HP MAX)	529	\$ 1,822.00
MB158-72	72" 1 5/8" TINE STYLE MANURE BUCKET (80 HP MIN)	676	\$ 1,955.00
MB158-78	78" 1 5/8" TINE STYLE MANURE BUCKET (80 HP MIN)	725	\$ 2,047.00
MB158-84	84" 1 5/8" TINE STYLE MANURE BUCKET (80 HP MIN)	774	\$ 2,140.00
MB158-90	90" 1 5/8" TINE STYLE MANURE BUCKET (80 HP MIN)	824	\$ 2,233.00
MB158-96	96" 1 5/8" TINE STYLE MANURE BUCKET (80 HP MIN)	873	\$ 2,326.00

MANURE BUCKET GRAPPLES

PART #	DESCRIPTION	WT	LIST PRICE
GF24-4	4-TINE FIXED SINGLE CYLINDER GRAPPLE FOR 1 1/4" TINED MANURE BUCKETS	192	\$ 830.00
GF25-4	4-TINE DOUBLE CYLINDER GRAPPLE FOR 1 5/8" TINED MANURE BUCKETS	298	\$ 1,439.00

DOZER BLADES

WELD ON MOUNT KITS ORDERED SEPARATELY

PART #	DESCRIPTION	WT	LIST PRICE
DOZ-08	8 FT Heavy Duty Dozer Blade with Skids	552	\$ 1,662.00
DOZ-10	10 FT Heavy Duty Dozer Blade with Skids	676	\$ 1,970.00
DOZ-12	12 FT Heavy Duty Dozer Blade with Skids	800	\$ 2,282.00
DOZ-08S	8 FT Heavy Duty Dozer Blade with Skids & 16" screen	708	\$ 2,333.00
DOZ-10S	10 FT Heavy Duty Dozer Blade with Skids & 16" screen	852	\$ 2,803.00
DOZ-12S	12 FT Heavy Duty Dozer Blade with Skids & 16" screen	1001	\$ 3,282.00
DOZ-W	BOLT On Wing Kit for Dozer	158	\$ 661.00

WELD ON mounting kits for Replacement Buckets, High Volume Buckets, Manure Buckets & Dozer Blades

Note: ALL Pin to Pin Loaders require schematic drawing

Part #	Description		LIST PRICE
5620-4	Agco FL300, FL400 & FL500 & MF 1040, 1050, 1060, 1070 & 1080 New Style WELD ON Mounting Kit	55	\$ 361.00
6820-4	Agco FL 600 & Massey-Ferguson 1090 "New Style" WELD ON Mounting Kit	55	\$ 361.00
7820-4	Allied/Buhler 395 QT WELD ON Mounting Kit	135	\$ 361.00
4620-4	Allied/Buhler 495, 595, & 695 QT WELD ON Mounting Kit	135	\$ 361.00

5820-4	Allied/Buhler 795 QT WELD ON Mounting Kit	135	\$ 361.00
4720-4	Allied/Buhler 895 & 995 QT WELD ON Mounting Kit	150	\$ 361.00
4820-4	Allied/Buhler 2495, 2595, 2596, 2795 & 2895 Quik-Tach WELD ON Mounting Kit	115	\$ 361.00
6020-4	Bush Hog M346, M446, M546 & M646 QT Series WELD ON Mounting Kit	105	\$ 416.00
6120-4	Bush Hog 2426, 2446 & 2846 Quik-Tach Series WELD ON Mounting Kit	105	\$ 416.00
7520-4	Bush Hog 3226 Quik-Tach Series WELD ON Mounting Kit	145	\$ 416.00
7620-4	Bush Hog 2346 Quik-Tach Series WELD ON Mounting Kit	120	\$ 416.00
3120-4	Case IH 2000 Series Pin On Loaders WELD ON Mounting Kit	70	\$ 361.00
3220-4	Case IH L300, IH 510 & IH 520 Quik-Tach Loaders WELD ON Mounting Kit	145	\$ 472.00
11820-4	Case IH 710 & IH890 Quik-Tach Series WELD ON Mounting Kit	115	\$ 514.00
9120-4	Case IH LX 192 & NH 92 LB WELD ON Mounting Kit	130	\$ 500.00
4120-4	Dual 340/345 Pin to Pin Series Loaders WELD ON Mounting Kit	60	\$ 361.00
6620-4	Dual 300/325 Pin to Pin Series Loaders WELD ON Mounting Kit	60	\$ 361.00
4220-4	Dual 205, 305, 255, 355, 310, 215, 315, 260, 360, 275 & 375 Quik-Tach Loaders WELD ON Mounting Kit	180	\$ 472.00
11920-4	Dual 3100 Pin to Pin Series Loaders WELD ON Mounting Kit	50	\$ 361.00
5220-4	Euro Hookup includes Agco 340 Alo-Quicke -Case IH - Cat Challenger - Fendt - JD 563 & 673 - KMW - Koyker 1585 & 2585 - Mc Cormick - NH - Stoll - Zetor (Complete listing on page 22) WELD ON Mounting Kit	75	\$ 365.00
4920-4	Farmhand F11 Quik-Tach Series Includes 235, 236, 248, 258 & 358 WELD ON Mounting Kit	155	\$ 445.00
5020-4	Farmhand XL590, 662, 740, 940, 1140 & 1340 Quik-Tach Loaders WELD ON Mounting Kit	55	\$ 361.00
5120-4	Farmhand XL 945 & 1145 Quik-Tach Loaders WELD ON Mounting Kit	50	\$ 361.00
3420-4	Ford New Holland 7109, 7209, 7309, 7210, 7310, & 7410 Quik-Tach Loaders WELD ON Mounting Kit	135	\$ 472.00
3520-4	Ford New Holland 72 LA, 7311, 7411, 7511, 7312,7313, 7412, 7413, & 7414 Quik-Tach Loaders WELD ON Mounting Kit	155	\$ 472.00
3820-4	Ford New Holland/Versatile Bi-Directional Loaders 156, 256, 276, 9030, 2360V, 7414V WELD ON Mounting Kit	110	\$ 416.00
3720-4	Ford New Holland TV 140, 145 & 6070 Bi-Directional Tractors with Model 7614 or Model 84LB Loaders WELD ON Mounting Kit	150	\$ 416.00
5320-4	Ford New Holland TV 140, 145 & 6070 Bi-Directional Tractors with Model 82LB Loaders WELD ON Mounting Kit	80	\$ 416.00
3920-4	Great Bend 360, 460, 660, 760, 860, 2136, 2140, 2144, 2157 & 2166 Quik-Tach Series Loaders WELD ON Mounting Kit	150	\$ 472.00
2120-4	JD 145,146,148 & 158 13" On Center Pin On Series Loaders WELD ON Mounting Kit	65	\$ 361.00
12020-4	JD 145 & 146 10" On Center Pin On Series Loaders WELD ON Mounting Kit	65	\$ 361.00
9320-4	JD 168 Pin On Series Loaders WELD ON Mounting Kit	65	\$ 361.00
2220-4	JD 175 Pin On Loaders WELD ON Mounting Kit	65	\$ 361.00
2320-4	JD 240, 245, 260 & 265 Quik-Tach Series Loaders WELD ON Mounting Kit	105	\$ 472.00
2420-4	JD 280 Loaders WELD ON Mounting Kit	132	\$ 472.00
2620-4	JD 200X, 200CX, 300X, 300CX, 400, 400X, 500 & 500X Quik-Tach Loaders WELD ON Mounting Kit	45	\$ 286.00
2720-4	JD 600/700 Pin On Series Loaders WELD ON Mounting Kit	80	\$ 361.00
2820-4	JD 600/700 Classic Quik-Tach Series Loaders WELD ON Mounting Kit	100	\$ 478.00
12520-4	JD H480 Quik-Tach Loader WELD ON Mounting Kit	200	\$ 685.00
2920-4	John Deere 840 Quik-Tach Series Loaders WELD ON Mounting Kit	120	\$ 522.00
3020-4	JD 48/58 Single Cylinder Loaders WELD ON Mounting Kit	80	\$ 462.00
11220-4	KD 5000, 5500, 6400, & 7400 Loaders with 1 3/8" Pins 13" On Center WELD ON Mounting Kit	80	\$ 361.00
11120-4	Koyker 180, 185, 190, 195, 210, 220, 235 & 245 Koyker Quik-Tach System WELD ON Mounting Kit	70	\$ 416.00
11020-4	Koyker 310, 345, 385, 445, 510, 545, 565, 585, 600 & 645 with Koyker Quik-Tach System WELD ON Mounting Kit	120	\$ 416.00
9020-4	Kubota LA1251 Quik-Tach Loaders WELD ON Mounting Kit	120	\$ 416.00
5420-4	Miller M12-P12 Quik-Tach Loader WELD ON Mounting Kit	50	\$ 685.00
6520-4	Miller PL2X, PL2 JR, PL2, GP25 & GL25 Quik-Tach WELD ON Mounting Kit	50	\$ 685.00
6920-4	Miller PL3, PL4, PL5, GL30, GP30, & GP 35 Quik-Tach Loader WELD ON Mounting Kit	50	\$ 685.00
9720-4	Miller G15 & G20 Quik-Tach WELD ON Mounting Kit	50	\$ 685.00
5520-4HD	Skid Steer for 1995 and Newer with Universal Skid Steer Hook-up WELD ON Mounting Kit (3/8" plate)	85	\$ 320.00
7120-4	Skid Steer Dog Ear Hook-up (NH L553-L554-L555-L775-L779-L781-L783-L784-L785-L865 WELD ON Mounting Kit	110	\$ 538.00

7220-4	Skid Steer Dog Ear Hook-up (NH L35-L424-L425-L445-L451-L452-L454-L455 WELD ON Mounting Kit	100	\$ 475.00
8320-4	Gehl 3725 & 3825 Quik-Tach WELD ON Mounting Kit	60	\$ 538.00
8420-4	Gehl 4625, 5625 & 6625 Series Quik-Tach WELD ON Mounting Kit	60	\$ 538.00
4320-4	Westendorf 20 Series Loader - (39 1/2" OC) WELD ON Mounting Kit w/Base Plate	100	\$ 328.00
4420-4	Westendorf 40 Series Loader - (45 1/2" OC) WELD ON Mounting Kit w/Base Plate	100	\$ 328.00
4520-4	Westendorf 70 Series Loader - (53 1/2" OC) WELD ON Mounting Kit w/Base Plate	100	\$ 328.00

TELEHANDLER LOADER MOUNTING KITS

11720-4	Bobcat Versahandler 518 & 723 Telehandler Series WELD ON Mounting Kit	225	\$ 950.00
12620-4	CAT TH 62-82-83 Series Telehandler WELD ON Mounting kit	235	\$ 890.00
12720-4	Gehl AL700 Series Telehandler WELD ON Mounting Kit	100	\$ 864.00
12820-4	Gehl Dynattach (Narrow - 11.5" inside measurement) - RS6 Telehandler WELD ON Mounting Kit	135	\$ 550.00
12920-4	Gehl Dynattach (Wide - 13" inside measurement) - RS5 Telehandler WELD ON Mounting Kit	140	\$ 585.00
13020-4	Gradall Telehandler 534D WELD ON Mounting Kit	147	\$ 861.00
13120-4	Ingersoll-Rand telehandler WELD ON Mounting Kit	140	\$ 890.00
13220-4	JCB 506C Series Telehandler WELD ON Mounting Kit	170	\$ 740.00
9520-4	JCB 520 Series Telehandler WELD ON Mounting Kit	185	\$ 861.00
7420-4	JCB 530-540/NH LM 430 (yellow) Telehandler "Q-Fit" Series WELD ON Mounting Kit	180	\$ 895.00
9420-4	JD 3200/3400/3800 Telehandler Series WELD ON Mounting Kit	200	\$ 800.00
13320-4	JLG Telehandler WELD ON Mounting Kit	250	\$ 895.00
13420-4	Lull Telehandler WELD ON Mounting Kit	145	\$ 745.00
11520-4	Manitou, NH LM 435 (blue) & Gehl CT618 & CT723 Mounting Kit WELD ON Mounting Kit	120	\$ 895.00
13520-4	NH M428, M427, M459 Telehandler WELD ON Mounting Kit	168	\$ 875.00

WHEEL LOADER MOUNTING KITS

12420-4	CAT IT Series 14-24-28/CAT 924 & 930G/CAT 406TH WELD ON Mounting kit	150	\$ 861.00
13620-4	CWS Canadian Coupler Wheel Loader WELD ON Mounting Kit	184	\$ 1,420.00
13720-4	Gehl AWS 36, Gehl 480, 480T, ML36 Series Wheel Loader WELD ON Mounting Kit	150	\$ 800.00
13820-4	Gehl AWS 46, Gehl 680, ML46 Series Wheel Loader WELD ON Mounting Kit	165	\$ 860.00
12120-4	JD 244J, JCB 409B, Komatsu WA95, Volvo L35 Compact Wheel Loader WELD ON Mounting Kit (for use on loader buckets - 1yd-1.5yd-2yd)	220	\$ 825.00
12220-4	JRB 500 Series QT (includes JD444/544, Case 521/621, Komatsu WA 200/320, NH LW170) WELD ON Mounting Kit	250	\$ 1,150.00
12220-4-2	JRB 500 Series QT (includes JD444/544, Case 521/621, Komatsu WA 200/320, NH LW170) WELD ON Mounting Kit - (2pc weld-on kit -- no base plate)	210	\$ 995.00
14020-4	JRB 600 Series QT (includes JD644, Komatsu WA380) WELD ON Mounting Kit	340	\$ 1,475.00
14020-4-2	JRB 600 Series QT (includes JD644, Komatsu WA380) WELD ON Mounting Kit (2 pc Kit - no base plate)	300	\$ 1,350.00
12320-4	Volvo Wheel Loader L-Series (L50-60-70-80-90-110-120) JCB 416 & 426 WELD ON Mounting Kit	180	\$ 861.00

****DUE TO VARIATIONS IN TELEHANDLER/WHEEL LOADER MODEL NUMBER & HOOKUP TYPES, VERIFICATION OF PART NUMBER IS NECESSARY BEFORE ORDERING****

This page intentionally left blank

TINE PRICING

STABBER TINE

PART #	DESCRIPTION	WEIGHT	LIFT CAP	LIST PRICE
C-139	1 3/8" X 39" STABBER TINE (33" useable)	12	1800	\$ 141.00
C-239	1 3/4" X 39" STABBER TINE (33" useable)	17	2200	\$ 163.00
C-248	1 3/4" X 48" STABBER TINE (43" useable)	19	2200	\$ 192.00

BUSHINGS FOR THE ABOVE TINES

PART #	DESCRIPTION	WEIGHT	LIFT CAP	LIST PRICE
C-1	BUSHINGS FOR ALL 1 3/8" TINES	3		\$ 21.00
C-2	BUSHINGS FOR ALL 1 3/4" TINES	4		\$ 34.00

STABILIZER TINES

PART #	DESCRIPTION	WEIGHT	LIFT CAP	LIST PRICE
ST-1	15" X 1 1/4" Stabilizer Tine for Single Round Bale Stabbers	4	N/A	\$ 39.00
ST-3	15" X 1 1/8" Stabilizer Tine for Single Round Bale Stabbers	4	N/A	\$ 37.00
ST-2	15" x 1" Tapered Stabilizer Tine for 8ft Sq Bale Stabbers	4	N/A	\$ 33.00

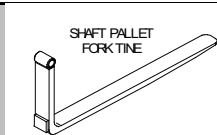

PALLET FORK TINES

SOLD IN PAIRS ONLY

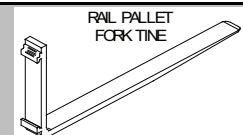

PART #	DESCRIPTION	WEIGHT	LIFT CAP	LIST PRICE
PFT-2	SHAFT MOUNT PALLET FORK TINES (sold in pairs only)	226	5500	\$ 763.00
PFT-T36	1 1/2" X 3" X 36" TUBULAR TINES	78	1800	\$ 325.00
PFT-T42	1 1/2" X 3" X 42" TUBULAR TINES	90	1800	\$ 325.00
PFT-E42	1 1/4" X 4" X 42" FULLY TAPERED TINES	146	2800	\$ 506.00
PFT-E46	1 1/4" X 4" X 46" FULLY TAPERED TINES	158	2800	\$ 506.00
PFT-31-2	1 1/4" X 4" X 42" CLASS 2 ITA RAIL TYPE PALLET FORK TINES	196	4000	\$ 520.00
PFT-31-6	1 1/4" X 4" X 46" CLASS 2 ITA RAIL TYPE PALLET FORK TINES	200	4000	\$ 520.00
PFT-31-8	1 1/4" X 4" X 48" CLASS 2 ITA RAIL TYPE PALLET FORK TINES	204	4000	\$ 520.00
PFT-32-2	1 1/2" X 4" X 42" CLASS 2 ITA RAIL TYPE PALLET FORK TINES	214	5200	\$ 676.00
PFT-32-6	1 1/2" X 4" X 46" CLASS 2 ITA RAIL TYPE PALLET FORK TINES	220	5200	\$ 676.00
PFT-32-8	1 1/2" X 4" X 48" CLASS 2 ITA RAIL TYPE PALLET FORK TINES	226	5200	\$ 676.00
PFT-34-6*	1 3/4" X 4" X 60" CLASS 2 ITA RAIL TYPE PALLET FORK TINES	300	5500	\$ 853.00
PFT-34-7*	1 3/4" X 4" X 72" CLASS 2 ITA RAIL TYPE PALLET FORK TINES	350	5500	\$ 1,119.00

*When substituting 60" tines add \$200.00 to list price of 1 1/2" tine units.

*When substituting 72" tines add \$445.00 to list price of 1 1/2" tine units.

MISCELLANEOUS

PART #	DESCRIPTION	WEIGHT	LIFT CAP	LIST PRICE
BCT-06	6 ft. Bolt On Bale Carrier Replacement Tine	73	N/A	\$ 140.00
JD 418	4 John Deere 148/158 attachment pins (1 1/8" x 6 1/2")	7	N/A	\$ 78.00
CSB-2	Cylinder Swivel Blocks (pin sizes 1 1/8" - 1 1/4" - 1 3/16")	2	N/A	\$ 95.00

This page intentionally left blank

TIRE GATOR

PALLET FORK REQUIRED (NOT INCLUDED)

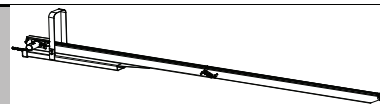

Part #	Description	Weight	Lift Cap.	List Price
TG-160	TIRE GATOR - Hydraulic Driven Tire Handling unit w/hoses & pioneer ends	350		\$ 2,025.00

3 Point Attachments

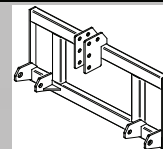

Fits Category 2, 3N and 3W

Part #	Description	Weight	Lift Cap.	List Price
3DBC-22-10	3-Point Two bale carrier with removable teeth (10 ft)	900	6000	\$ 1,640.00
3DBC-22-12	3-Point Two bale carrier with removable teeth (12 ft)	900	6000	\$ 1,726.00
5702	3-Point Single Tine Bale Stabber	160	2500	\$ 714.00
5703	3-Point Double Tine Bale Stabber	165	4400	\$ 894.00
5704	3-Point Double Tine Double Bale Stabber Units available w/BOLT ON mounts - see page 5	425	6000	\$ 1,935.00

Fits Category 2 and 3N (32" WIDE)

3BC-211	3-Point Single bale carrier with removable teeth	280	3000	\$ 798.00
5700	3-Point Economy Single Tine Bale Stabber	110	1800	\$ 388.00
5701	3-Point 5th Wheel Gooseneck Trailer Hitch with Draw Bar	90	N/A	\$ 276.00
5701-R	3-Point 5th Wheel Gooseneck Trailer Hitch with Class 2 Receiver Hitch	95	N/A	\$ 330.00
4500HD	HERCULIFT 3-point Adjustable Tine High Lift Pallet Fork	740	5500	\$ 2,985.00

Fits Category 3 WIDE (38" WIDE)

5701-C3	3-Point 5th Wheel Gooseneck Trailer Hitch with Draw Bar for Cat 3	90	N/A	\$ 342.00
5701-RC3	3-Point 5th Wheel Gooseneck Trailer Hitch with Class 2 Receiver Hitch for Cat 3	95	N/A	\$ 439.00

Agco FL300, FL400 & FL500 Quik-Tach Series Loaders Massey-Ferguson 1040, 1050, 1060, 1070 & 1080 DL280

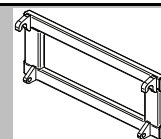

"New Style" Quik-Tach Series Loaders

Part #	Description	Weight	Lift Cap.	List Price
5600	Single Tine Bale Stabber with Stabilizer Tines	140	2500	\$ 660.00
5602	Double Tine Bale Stabber - 1 bale capacity	145	4400	\$ 834.00
5605	Pallet Fork - Shaft Style w/roll guard (1 5/8" shaft)	495	5500	\$ 1,656.00
5615-1248	Pallet Fork - Rail Style with 1 1/2" x 48" Tines	420	5200	\$ 1,352.00
5515-00	Single Tine Bale Stabber adapter for Rail Style Pallet Fork	75	2500	\$ 400.00
5515-02	Double Tine Bale Stabber adapter for Rail Style Pallet Fork	100	4400	\$ 533.00
5607	Pallet Fork (Shaft) with Inverted Tine package	610	Fork 5500 Inv 4000	\$ 2,211.00
5608	Pallet Fork (Shaft) with Telescopic Boom -	625	Fork 5500 Boom 4400	\$ 2,409.00
5611	Telescopic Boom	325	Max 7000	\$ 1,105.00
5619	UNI-TACH Skid Steer Attachment Carrier	135	4000	\$ 963.00

Rock Bucket pricing page 3

Roto-King & 8 ft Sq. Bale Stabbers pricing page 4

Double Round Bale Stabbers & Sur-Grip Bale Grabber pricing page 5

Replacement Buckets pricing page 11 & High Volume Bucket pricing page 12

Manure Buckets & Dozer Blade pricing page 13

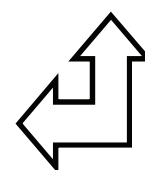
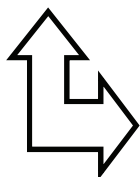

Agco FL600 Quik-Tach Loaders

Massey-Ferguson 1090 "New Style" Quik-Tach Loaders

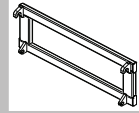

Part #	Description	Weight	Lift Cap.	List Price
6800	Single Tine Bale Stabber with Stabilizer Tines	140	2500	\$ 660.00
6802	Double Tine Bale Stabber - 1 bale capacity	145	4400	\$ 834.00
6805	Pallet Fork - Shaft Style w/roll guard (1 5/8" shaft)	495	5500	\$ 1,656.00
6815-1248	Pallet Fork - Rail Style with 1 1/2" x 48" Tines	420	5200	\$ 1,352.00
5515-00	Single Tine Bale Stabber adapter for Rail Style Pallet Fork	75	2500	\$ 400.00
5515-02	Double Tine Bale Stabber adapter for Rail Style Pallet Fork	100	4400	\$ 533.00
6807	Pallet Fork (Shaft) with Inverted Tine package	610	Fork 5500 Inv 4000	\$ 2,211.00
6808	Pallet Fork (Shaft) with Telescopic Boom -	625	Fork 5500 Boom 4400	\$ 2,409.00
6811	Telescopic Boom	325	Max 7000	\$ 1,105.00
6819	UNI-TACH Skid Steer Attachment Carrier	135	4000	\$ 963.00

Rock Bucket pricing page 3

Roto-King & 8 ft Sq. Bale Stabbers pricing page 4

Double Round Bale Stabbers & Sur-Grip Bale Grabber pricing page 5

Replacement Buckets pricing page 11 & High Volume Bucket pricing page 12

Manure Buckets & Dozer Blade pricing page 13

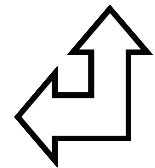
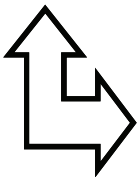

Allied/Buhler 395 Quik-Tach Series Loaders

36 1/2" On Center

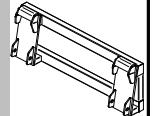

Part #	Description	Weight	Lift Cap.	List Price
7800	Single Tine Bale Stabber with Stabilizer Tines	140	2500	\$ 660.00
7802	Double Tine Bale Stabber - 1 bale capacity	145	4400	\$ 834.00
7805	Pallet Fork - Shaft Style w/roll guard (1 5/8" shaft)	495	5500	\$ 1,656.00
7815-1248	Pallet Fork - Rail Style with 1 1/2" x 48" Tines	420	5200	\$ 1,352.00
5515-00	Single Tine Bale Stabber adapter for Rail Style Pallet Fork	75	2500	\$ 400.00
5515-02	Double Tine Bale Stabber adapter for Rail Style Pallet Fork	100	4400	\$ 533.00
7807	Pallet Fork (Shaft) with Inverted Tine package	610	Fork 5500 Inv 4000	\$ 2,211.00
7808	Pallet Fork (Shaft) with Telescopic Boom -	625	Fork 5500 Boom 4400	\$ 2,409.00
7811	Telescopic Boom	325	Max 7000	\$ 1,105.00
7819	UNI-TACH Skid Steer Attachment Carrier	135	4000	\$ 963.00

Rock Bucket pricing page 3

Roto-King & 8 ft Sq. Bale Stabbers pricing page 4

Double Round Bale Stabbers & Sur-Grip Bale Grabber pricing page 5

Replacement Buckets pricing page 11 & High Volume Bucket pricing page 12

Manure Buckets & Dozer Blade pricing page 13

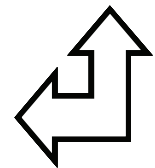
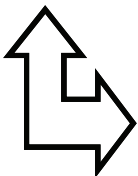

Allied/Buhler 495, 595 & 695 Quik-Tach Series Loaders

40 1/2" On Center

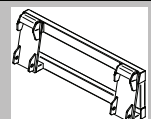

Part #	Description	Weight	Lift Cap.	List Price
4600	Single Tine Bale Stabber with Stabilizer Tines	140	2500	\$ 660.00
4602	Double Tine Bale Stabber - 1 bale capacity	145	4400	\$ 834.00
4605	Pallet Fork - Shaft Style w/roll guard (1 5/8" shaft)	495	5500	\$ 1,656.00

4615-1248	Pallet Fork - Rail Style with 1 1/2" x 48" Tines	420	5200	\$ 1,352.00
5515-00	Single Tine Bale Stabber adapter for Rail Style Pallet Fork	75	2500	\$ 400.00
5515-02	Double Tine Bale Stabber adapter for Rail Style Pallet Fork	100	4400	\$ 533.00
4607	Pallet Fork (Shaft) with Inverted Tine package	610	Fork 5500 Inv 4000	\$ 2,211.00
4608	Pallet Fork (Shaft) with Telescopic Boom -	625	Fork 5500 Boom 4400	\$ 2,409.00
4611	Telescopic Boom	325	Max 7000	\$ 1,105.00
4619	UNI-TACH Skid Steer Attachment Carrier	135	4000	\$ 963.00

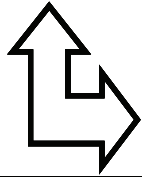

Rock Bucket pricing page 3
Roto-King & 8 ft Sq. Bale Stabbers pricing page 4
Double Round Bale Stabbers & Sur-Grip Bale Grabber pricing page 5
Replacement Buckets pricing page 11 & High Volume Bucket pricing page 12
Manure Buckets & Dozer Blade pricing page 13

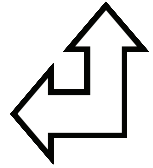

Allied/Buhler 795 Quik-Tach Series Loader

44 1/2" On Center

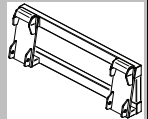

Part #	Description	Weight	Lift Cap.	List Price
5800	Single Tine Bale Stabber with Stabilizer Tines	140	2500	\$ 660.00
5802	Double Tine Bale Stabber - 1 bale capacity	145	4400	\$ 834.00
5805	Pallet Fork - Shaft Style w/roll guard (1 5/8" shaft)	495	5500	\$ 1,656.00
5815-1248	Pallet Fork - Rail Style with 1 1/2" x 48" Tines	420	5200	\$ 1,352.00
5515-00	Single Tine Bale Stabber adapter for Rail Style Pallet Fork	75	2500	\$ 400.00
5515-02	Double Tine Bale Stabber adapter for Rail Style Pallet Fork	100	4400	\$ 533.00
5807	Pallet Fork (Shaft) with Inverted Tine package	610	Fork 5500 Inv 4000	\$ 2,211.00
5808	Pallet Fork (Shaft) with Telescopic Boom -	625	Fork 5500 Boom 4400	\$ 2,409.00
5811	Telescopic Boom	325	Max 7000	\$ 1,105.00
5819	UNI-TACH Skid Steer Attachment Carrier	135	4000	\$ 963.00

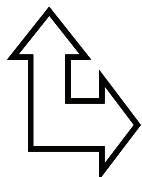

Rock Bucket pricing page 3
Roto-King & 8 ft Sq. Bale Stabbers pricing page 4
Double Round Bale Stabbers & Sur-Grip Bale Grabber pricing page 5
Replacement Buckets pricing page 11 & High Volume Bucket pricing page 12
Manure Buckets & Dozer Blade pricing page 13

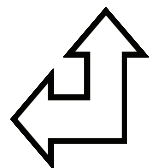

Allied/Buhler 895 & 995 Quik-Tach Series Loaders

48 1/2" On Center - Requires 7" Kick Out Mounts

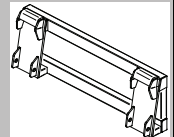

Part #	Description	Weight	Lift Cap.	List Price
4700	Single Tine Bale Stabber with Stabilizer Tines	140	2500	\$ 660.00
4702	Double Tine Bale Stabber - 1 bale capacity	145	4400	\$ 834.00
4705	Pallet Fork - Shaft Style w/roll guard (1 5/8" shaft)	495	5500	\$ 1,656.00
4715-1248	Pallet Fork - Rail Style with 1 1/2" x 48" Tines	420	5200	\$ 1,352.00
5515-00	Single Tine Bale Stabber adapter for Rail Style Pallet Fork	75	2500	\$ 400.00
5515-02	Double Tine Bale Stabber adapter for Rail Style Pallet Fork	100	4400	\$ 533.00
4707	Pallet Fork (Shaft) with Inverted Tine package	610	Fork 5500 Inv 4000	\$ 2,211.00
4708	Pallet Fork (Shaft) with Telescopic Boom -	625	Fork 5500 Boom 4400	\$ 2,409.00
4711	Telescopic Boom	325	Max 7000	\$ 1,105.00
4719	UNI-TACH Skid Steer Attachment Carrier	135	4000	\$ 963.00

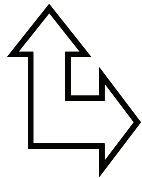

Rock Bucket pricing page 3
Roto-King & 8 ft Sq. Bale Stabbers pricing page 4
Double Round Bale Stabbers & Sur-Grip Bale Grabber pricing page 5
Replacement Buckets pricing page 11 & High Volume Bucket pricing page 12
Manure Buckets & Dozer Blade pricing page 13

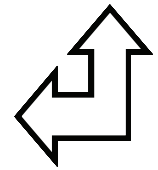

Allied 2495, 2595, 2596, 2795 & 2895 Quik-Tach Series Loaders

Note: "E" series see Euro page 22

Buhler 2895 & 3895

Mid-Mount Series Loaders

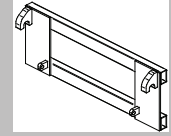

Part #	Description	Weight	Lift Cap.	List Price
4800	Single Tine Bale Stabber with Stabilizer Tines	140	2500	\$ 660.00
4802	Double Tine Bale Stabber - 1 bale capacity	145	4400	\$ 834.00
4805	Pallet Fork - Shaft Style w/roll guard (1 5/8" shaft)	495	5500	\$ 1,656.00
4815-1248	Pallet Fork - Rail Style with 1 1/2" x 48" Tines	420	5200	\$ 1,352.00
5515-00	Single Tine Bale Stabber adapter for Rail Style Pallet Fork	75	2500	\$ 400.00
5515-02	Double Tine Bale Stabber adapter for Rail Style Pallet Fork	100	4400	\$ 533.00
4807	Pallet Fork (Shaft) with Inverted Tine package	610	Fork 5500 Inv 4000	\$ 2,211.00
4808	Pallet Fork (Shaft) with Telescopic Boom -	625	Fork 5500 Boom 4400	\$ 2,409.00
4811	Telescopic Boom	325	Max 7000	\$ 1,105.00
4819	UNI-TACH Skid Steer Attachment Carrier	135	4000	\$ 963.00

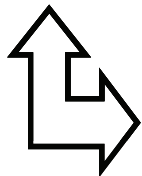

Rock Bucket pricing page 3
Roto-King & 8 ft Sq. Bale Stabbers pricing page 4
Double Round Bale Stabbers & Sur-Grip Bale Grabber pricing page 5
Replacement Buckets pricing page 11 & High Volume Bucket pricing page 12
Manure Buckets & Dozer Blade pricing page 13

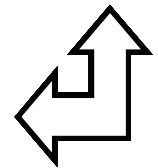

ALO-QUICKIE 700 & 900 LOADERS

SEE "EURO" HOOK UP PAGE 28

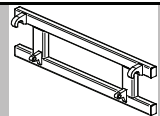

Bush Hog M346, M446, M546 & M646 QuikTach Series Loaders

Mid-Mount Series Loaders

Verify if unit has BushHog QT or Skid Steer Universal Mount

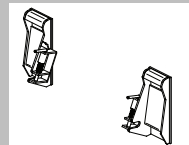

Part #	Description	Weight	Lift Cap.	List Price
6000	Single Tine Bale Stabber with Stabilizer Tines	140	2500	\$ 660.00
6002	Double Tine Bale Stabber - 1 bale capacity	145	4400	\$ 834.00
6005	Pallet Fork - Shaft Style w/roll guard (1 5/8" shaft)	495	5500	\$ 1,656.00
6015-1248	Pallet Fork - Rail Style with 1 1/2" x 48" Tines	420	5200	\$ 1,352.00
5515-00	Single Tine Bale Stabber adapter for Rail Style Pallet Fork	75	2500	\$ 400.00
5515-02	Double Tine Bale Stabber adapter for Rail Style Pallet Fork	100	4400	\$ 533.00
6007	Pallet Fork (Shaft) with Inverted Tine package	610	Fork 5500 Inv 4000	\$ 2,211.00
6008	Pallet Fork (Shaft) with Telescopic Boom -	625	Fork 5500 Boom 4400	\$ 2,409.00
6011	Telescopic Boom	325	Max 7000	\$ 1,105.00
6019	UNI-TACH Skid Steer Attachment Carrier	135	4000	\$ 963.00

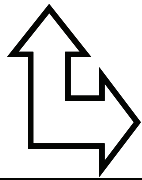

Rock Bucket pricing page 3
Roto-King & 8 ft Sq. Bale Stabbers pricing page 4
Double Round Bale Stabbers & Sur-Grip Bale Grabber pricing page 5
Replacement Buckets pricing page 11 & High Volume Bucket pricing page 12
Manure Buckets & Dozer Blade pricing page 13

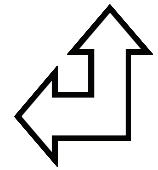

Bush Hog 2426, 2446 & 2846 Quik-Tach Series Loaders



Part #	Description	Weight	Lift Cap.	List Price
6100	Single Tine Bale Stabber with Stabilizer Tines	140	2500	\$ 660.00
6102	Double Tine Bale Stabber - 1 bale capacity	145	4400	\$ 834.00
6105	Pallet Fork - Shaft Style w/roll guard (1 5/8" shaft)	495	5500	\$ 1,656.00
6115-1248	Pallet Fork - Rail Style with 1 1/2" x 48" Tines	420	5200	\$ 1,352.00
5515-00	Single Tine Bale Stabber adapter for Rail Style Pallet Fork	75	2500	\$ 400.00
5515-02	Double Tine Bale Stabber adapter for Rail Style Pallet Fork	100	4400	\$ 533.00
6107	Pallet Fork (Shaft) with Inverted Tine package	610	Fork 5500 Inv 4000	\$ 2,211.00
6108	Pallet Fork (Shaft) with Telescopic Boom -	625	Fork 5500 Boom 4400	\$ 2,409.00
6111	Telescopic Boom	325	Max 7000	\$ 1,105.00
6119	UNI-TACH Skid Steer Attachment Carrier	145	4000	\$ 963.00

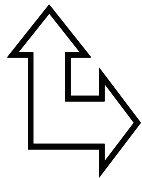

Rock Bucket pricing page 3
Roto-King & 8 ft Sq. Bale Stabbers pricing page 4
Double Round Bale Stabbers & Sur-Grip Bale Grabber pricing page 5
Replacement Buckets pricing page 11 & High Volume Bucket pricing page 12
Manure Buckets & Dozer Blade pricing page 13

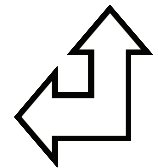

Bush Hog 2346 Quik-Tach Series Loaders



Part #	Description	Weight	Lift Cap.	List Price
7600	Single Tine Bale Stabber with Stabilizer Tines	140	2500	\$ 660.00
7602	Double Tine Bale Stabber - 1 bale capacity	145	4400	\$ 834.00
7605	Pallet Fork - Shaft Style w/roll guard (1 5/8" shaft)	495	5500	\$ 1,656.00
7615-1248	Pallet Fork - Rail Style with 1 1/2" x 48" Tines	420	5200	\$ 1,352.00
5515-00	Single Tine Bale Stabber adapter for Rail Style Pallet Fork	75	2500	\$ 400.00
5515-02	Double Tine Bale Stabber adapter for Rail Style Pallet Fork	100	4400	\$ 533.00
7607	Pallet Fork (Shaft) with Inverted Tine package	610	Fork 5500 Inv 4000	\$ 2,211.00
7608	Pallet Fork (Shaft) with Telescopic Boom -	625	Fork 5500 Boom 4400	\$ 2,409.00
7611	Telescopic Boom	325	Max 7000	\$ 1,105.00
7619	UNI-TACH Skid Steer Attachment Carrier	145	4000	\$ 963.00

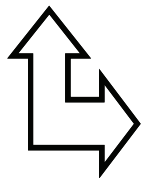

Rock Bucket pricing page 3
Roto-King & 8 ft Sq. Bale Stabbers pricing page 4
Double Round Bale Stabbers & Sur-Grip Bale Grabber pricing page 5
Replacement Buckets pricing page 11 & High Volume Bucket pricing page 12
Manure Buckets & Dozer Blade pricing page 13

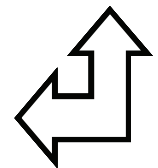

Bush Hog 3226

Quik-Tach Series Loaders

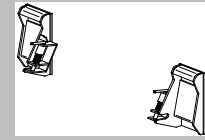

Part #	Description	Weight*	Lift Cap.	List Price
7500	Single Tine Bale Stabber with Stabilizer Tines	140	2500	\$ 732.00
7502	Double Tine Bale Stabber - 1 bale capacity	145	4400	\$ 860.00
7505	Pallet Fork - Shaft Style w/roll guard (1 5/8" shaft)	495	5500	\$ 1,700.00
7515-1248	Pallet Fork - Rail Style with 1 1/2" x 48" Tines	420	5200	\$ 1,427.00
5515-00	Single Tine Bale Stabber adapter for Rail Style Pallet Fork	75	2500	\$ 400.00
5515-02	Double Tine Bale Stabber adapter for Rail Style Pallet Fork	100	4400	\$ 533.00
7507	Pallet Fork (Shaft) with Inverted Tine package	610	Fork 5500 Inv 4000	\$ 2,240.00
7508	Pallet Fork (Shaft) with Telescopic Boom -	625	Fork 5500 Boom 4400	\$ 2,440.00
7511	Telescopic Boom	325	Max 7000	\$ 1,134.00
7519	UNI-TACH Skid Steer Attachment Carrier	155	4000	\$ 1,055.00

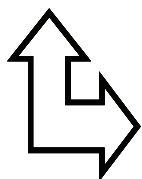

Rock Bucket pricing page 3
Roto-King & 8 ft Sq. Bale Stabbers pricing page 4
Double Round Bale Stabbers & Sur-Grip Bale Grabber pricing page 5
Replacement Buckets pricing page 11 & High Volume Bucket pricing page 12
Manure Buckets & Dozer Blade pricing page 13

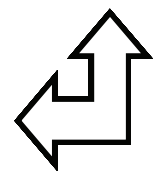

Case IH 2000 Series

Pin on Series Loaders - Schematic Drawing Required

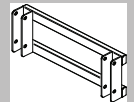

Part #	Description	Weight*	Lift Cap.	List Price
3100	Single Tine Bale Stabber with Stabilizer Tines	140	2500	\$ 660.00
3102	Double Tine Bale Stabber - 1 bale capacity	145	4400	\$ 834.00
3105	Pallet Fork - Shaft Style w/roll guard (1 5/8" shaft)	495	5500	\$ 1,656.00
3115-1248	Pallet Fork - Rail Style with 1 1/2" x 48" Tines	420	5200	\$ 1,352.00
5515-00	Single Tine Bale Stabber adapter for Rail Style Pallet Fork	75	2500	\$ 400.00
5515-02	Double Tine Bale Stabber adapter for Rail Style Pallet Fork	100	4400	\$ 533.00
3107	Pallet Fork (Shaft) with Inverted Tine package	610	Fork 5500 Inv 4000	\$ 2,211.00
3108	Pallet Fork (Shaft) with Telescopic Boom -	625	Fork 5500 Boom 4400	\$ 2,409.00
3111	Telescopic Boom	325	Max 7000	\$ 1,105.00
3119	UNI-TACH Skid Steer Attachment Carrier	140	4000	\$ 884.00

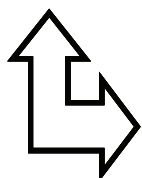

Rock Bucket pricing page 3
Roto-King & 8 ft Sq. Bale Stabbers pricing page 4
Double Round Bale Stabbers & Sur-Grip Bale Grabber pricing page 5
Replacement Buckets pricing page 11 & High Volume Bucket pricing page 12
Manure Buckets & Dozer Blade pricing page 13

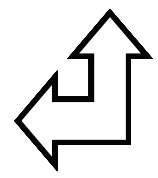

Case IH L 300, IH 510 & IH 520

Quik-Tach Series Loaders

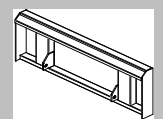

Part #	Description	Weight*	Lift Cap.	List Price
N/A	Single Tine Bale Stabber with Stabilizer Tines	N/A	N/A	N/A
3202	Double Tine Bale Stabber - 1 bale capacity	245	4400	\$ 890.00
3205	Pallet Fork - Shaft Style w/roll guard (1 5/8" shaft)	490	5500	\$ 1,738.00
3215-1248	Pallet Fork - Rail Style with 1 1/2" x 48" Tines	420	5200	\$ 1,427.00

5515-00	Single Tine Bale Stabber adapter for Rail Style Pallet Fork	75	2500	\$ 400.00
5515-02	Double Tine Bale Stabber adapter for Rail Style Pallet Fork	100	4400	\$ 533.00
3207	Pallet Fork (Shaft) with Inverted Tine package	590	Fork 5500 Inv 4000	\$ 2,290.00
3208	Pallet Fork (Shaft) with Telescopic Boom -	625	Fork 5500 Boom 4400	\$ 2,495.00
3211	Telescopic Boom	325	Max 7000	\$ 1,160.00
3219	UNI-TACH Skid Steer Attachment Carrier	155	4000	\$ 1,119.00

GREAT BEND & CASE/IH LOADER OEM REPLACEMENT GRAPPLES

These grapples fit the following loader models only: **GB 330, 340, 360, 440, 660, 760, 860, 2136, 2140, 2144, 2157, 2166 - CASE/IH 510, 520, L300 - CASE/IH LX SERIES LX156, LX162, LX162, LX172, LX720, LX730, LX740, LX760, LX770, LX780**

Part #	Description	Weight*	Lift Cap.	List Price
GBL-524B	4-TINE GRAPPLE for GREAT BEND & CASE/IH OEM BUCKETS LISTED ABOVE	525		\$ 2,195.00
GBL-525B	5-TINE GRAPPLE for GREAT BEND & CASE/IH OEM BUCKETS LISTED ABOVE	545		\$ 2,355.00

Rock Bucket pricing page 3

Roto-King & 8 ft Sq. Bale Stabbers pricing page 4

Double Round Bale Stabbers & Sur-Grip Bale Grabber pricing page 5

Replacement Buckets pricing page 11 & High Volume Bucket pricing page 12

Manure Buckets & Dozer Blade pricing page 13

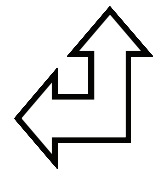
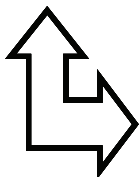

Case IH 710 & IH 890

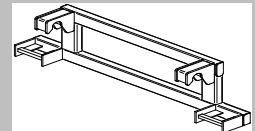

Quik-Tach Series Loaders

Part #	Description	Weight*	Lift Cap.	List Price
N/A	Single Tine Bale Stabber with Stabilizer Tines	N/A	N/A	N/A
11802	Double Tine Bale Stabber - 1 bale capacity	245	4400	\$ 1,086.00
11805	Pallet Fork - Shaft Style w/roll guard (1 5/8" shaft)	490	5500	\$ 1,852.00
11815-1248	Pallet Fork - Rail Style with 1 1/2" x 48" Tines	420	5200	\$ 1,731.00
5515-00	Single Tine Bale Stabber adapter for Rail Style Pallet Fork	75	2500	\$ 400.00
5515-02	Double Tine Bale Stabber adapter for Rail Style Pallet Fork	100	4400	\$ 533.00
11807	Pallet Fork (Shaft) with Inverted Tine package	590	Fork 5500 Inv 4000	\$ 2,405.00
11808	Pallet Fork (Shaft) with Telescopic Boom -	625	Fork 5500 Boom 4400	\$ 2,609.00
11811	Telescopic Boom	325	Max 7000	\$ 1,274.00
11819	UNI-TACH Skid Steer Attachment Carrier	155	4000	\$ 1,236.00

Rock Bucket pricing page 3

Roto-King & 8 ft Sq. Bale Stabbers pricing page 4

Double Round Bale Stabbers & Sur-Grip Bale Grabber pricing page 5

Replacement Buckets pricing page 11 & High Volume Bucket pricing page 12

Manure Buckets & Dozer Blade pricing page 13

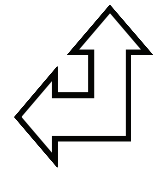
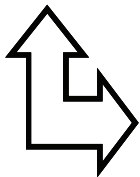

Case IH L 400, 500, 600, 700, & 800 Quik-Tach Series

SEE "EURO" HOOK UP PAGE 28

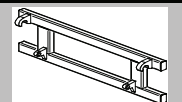

Case IH LX720, LX730, LX740, LX750, LX760, LX770 & LX780 Quik-Tach Series Loaders

SEE "EURO" HOOK UP PAGE 28

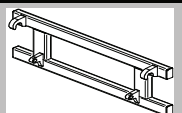

Case IH LX 156, 162, 172 Quik-Tach Series Loaders

SEE "EURO" HOOK UP PAGE 28

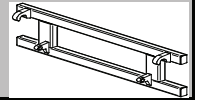

Case IH LX126, LX132, LX232, LX152, LX252

SEE UNIVERSAL SKID STEER STYLE HOOK UP

SEE PAGE 45

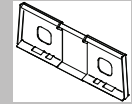

Case IH LX 192 Quik-Tach Series Loaders

New Holland 92LB Series Loaders

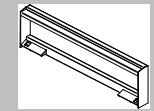

Part #	Description	Weight*	Lift Cap.	List Price
N/A	Single Tine Bale Stabber with Stabilizer Tines			N/A
9102	Double Tine Bale Stabber - 1 bale capacity	145	4400	\$ 878.00
9105	Pallet Fork - Shaft Style w/roll guard (1 5/8" shaft)	495	5500	\$ 1,738.00
9115-1248	Pallet Fork - Rail Style with 1 1/2" x 48" Tines	420	5200	\$ 1,427.00
5515-00	Single Tine Bale Stabber adapter for Rail Style Pallet Fork	75	2500	\$ 400.00
5515-02	Double Tine Bale Stabber adapter for Rail Style Pallet Fork	100	4400	\$ 533.00
9107	Pallet Fork (Shaft) with Inverted Tine package	610	Fork 5500 Inv 4000	\$ 2,291.00
9108	Pallet Fork (Shaft) with Telescopic Boom -	625	Fork 5500 Boom 4400	\$ 2,440.00
9111	Telescopic Boom	325	Max 7000	\$ 1,134.00
9119	UNI-TACH Skid Steer Attachment Carrier	155	4000	\$ 1,055.00

Rock Bucket pricing page 3

Roto-King & 8 ft Sq. Bale Stabbers pricing page 4

Double Round Bale Stabbers & Sur-Grip Bale Grabber pricing page 5

Replacement Buckets pricing page 11 & High Volume Bucket pricing page 12

Manure Buckets & Dozer Blade pricing page 13

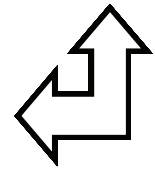
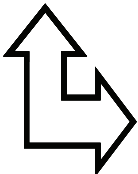

Cat Challenger ML Series Loaders

SEE "EURO" HOOK UP PAGE 26

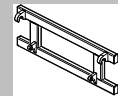

Dual 320/325 Pin to Pin Loaders

7/8" Top & 3/4" Bottom Pin

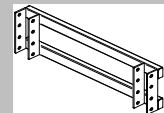

Part #	Description	Weight	Lift Cap.	List Price
6600	Single Tine Bale Stabber with Stabilizer Tines	195	2500	\$ 660.00
6602	Double Tine Bale Stabber - 1 bale capacity	210	4400	\$ 834.00
6615-1448	Pallet Fork - Rail Style with 1 1/4" x 48" Tines	400	4000	\$ 1,352.00
5515-00	Single Tine Bale Stabber adapter for Rail Style Pallet Fork	75	2500	\$ 400.00
5515-02	Double Tine Bale Stabber adapter for Rail Style Pallet Fork	100	4400	\$ 533.00
6619	UNI-TACH Skid Steer Attachment Carrier	175	4000	\$ 963.00

Rock Bucket pricing page 3

Roto-King & 8 ft Sq. Bale Stabbers pricing page 4

Double Round Bale Stabbers & Sur-Grip Bale Grabber pricing page 5

Replacement Buckets pricing page 11 & High Volume Bucket pricing page 12

Manure Buckets & Dozer Blade pricing page 13

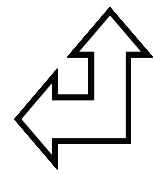
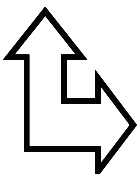

Dual 340/345 Pin to Pin Series Loaders

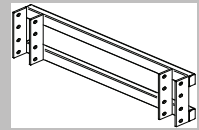

1" Top & Bottom Pins

Part #	Description	Weight*	Lift Cap.	List Price
4100	Single Tine Bale Stabber with Stabilizer Tines	140	2500	\$ 660.00
4102	Double Tine Bale Stabber - 1 bale capacity	145	4400	\$ 834.00
4105	Pallet Fork - Shaft Style w/roll guard (1 5/8" shaft)	495	5500	\$ 1,656.00
4115-1248	Pallet Fork - Rail Style with 1 1/2" x 48" Tines	420	5200	\$ 1,352.00
5515-00	Single Tine Bale Stabber adapter for Rail Style Pallet Fork	75	2500	\$ 400.00
5515-02	Double Tine Bale Stabber adapter for Rail Style Pallet Fork	100	4400	\$ 533.00
4107	Pallet Fork (Shaft) with Inverted Tine package	610	Fork 5500 Inv 4000	\$ 2,211.00
4108	Pallet Fork (Shaft) with Telescopic Boom -	625	Fork 5500 Boom 4400	\$ 2,409.00
4111	Telescopic Boom	325	Max 7000	\$ 1,105.00
4119	UNI-TACH Skid Steer Attachment Carrier	175	4000	\$ 963.00

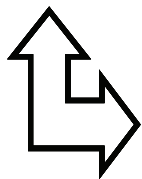

Rock Bucket pricing page 3
Roto-King & 8 ft Sq. Bale Stabbers pricing page 4
Double Round Bale Stabbers & Sur-Grip Bale Grabber pricing page 5
Replacement Buckets pricing page 11 & High Volume Bucket pricing page 12
Manure Buckets & Dozer Blade pricing page 13

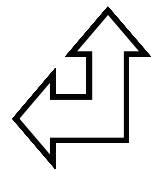

Dual 205,305, 255, 355, 210, 310, 215, 315, 260, 360, 275 & 375

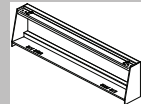

Quik-Tach Series Loaders

Part #	Description	Weight*	Lift Cap.	List Price
N/A	Single Tine Bale Stabber with Stabilizer Tines			N/A
4202	Double Tine Bale Stabber - 1 bale capacity	210	4400	\$ 890.00
4205	Pallet Fork - Shaft Style w/roll guard (1 5/8" shaft)	510	5500	\$ 1,738.00
4215-1248	Pallet Fork - Rail Style with 1 1/2" x 48" Tines	420	5200	\$ 1,427.00
5515-00	Single Tine Bale Stabber adapter for Rail Style Pallet Fork	75	2500	\$ 400.00
5515-02	Double Tine Bale Stabber adapter for Rail Style Pallet Fork	100	4400	\$ 533.00
4207	Pallet Fork (Shaft) with Inverted Tine package	635	Fork 5500 Inv 4000	\$ 2,291.00
4208	Pallet Fork (Shaft) with Telescopic Boom -	645	Fork 5500 Boom 4400	\$ 2,440.00
4211	Telescopic Boom	325	Max 7000	\$ 1,134.00
4219	UNI-TACH Skid Steer Attachment Carrier	210	4000	\$ 1,096.00

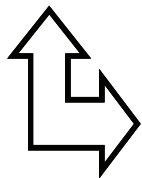

Rock Bucket pricing page 3
Roto-King & 8 ft Sq. Bale Stabbers pricing page 4
Double Round Bale Stabbers & Sur-Grip Bale Grabber pricing page 5
Replacement Buckets pricing page 11 & High Volume Bucket pricing page 12
Manure Buckets & Dozer Blade pricing page 13

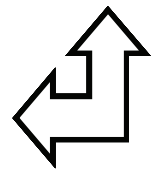

Dual 3100 Pin to Pin Loaders

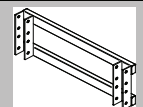

Schematic Drawing required

Part #	Description	Weight*	Lift Cap.	List Price
11900	Single Tine Bale Stabber with Stabilizer Tines	140	2500	\$ 660.00
11902	Double Tine Bale Stabber - 1 bale capacity	145	4400	\$ 834.00
11905	Pallet Fork - Shaft Style w/roll guard (1 5/8" shaft)	495	5500	\$ 1,656.00

11915-1248	Pallet Fork - Rail Style with 1 1/2" x 48" Tines	420	5200	\$ 1,352.00
5515-00	Single Tine Bale Stabber adapter for Rail Style Pallet Fork	75	2500	\$ 400.00
5515-02	Double Tine Bale Stabber adapter for Rail Style Pallet Fork	100	4400	\$ 533.00
11907	Pallet Fork (Shaft) with Inverted Tine package	610	Fork 5500 Inv 4000	\$ 2,211.00
11908	Pallet Fork (Shaft) with Telescopic Boom -	625	Fork 5500 Boom 4400	\$ 2,409.00
11911	Telescopic Boom	325	Max 7000	\$ 1,105.00
11919	UNI-TACH Skid Steer Attachment Carrier	175	4000	\$ 963.00

Rock Bucket pricing page 3

Roto-King & 8 ft Sq. Bale Stabbers pricing page 4

Double Round Bale Stabbers & Sur-Grip Bale Grabber pricing page 5

Replacement Buckets pricing page 11 & High Volume Bucket pricing page 12

Manure Buckets & Dozer Blade pricing page 13

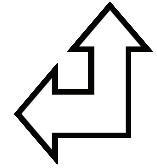
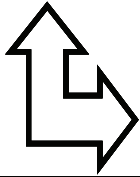

EURO HOOK UP LOADERS

AGCO 340

ALO-QUICKE Q700, Q720, Q730, Q740, Q750, Q760, Q900, Q935, Q945, Q955, Q965, Q975, Q985, Q1090

CASE IH L400, L405, L450, L455, L500, L505, L550, L555, L600, L605, L650, L655, L700, L705, L750, L755, L800, L805, L850, L855, LX156, LX162, LX172, LX720, LX730, LX740, LX760, LX770, LX780

CAT CHALLENGER ML72, ML75, ML77, ML92, ML94, ML96, ML97, ML98, ML99

FENDT LOADERS

JOHN DEERE 552, 553, 563 & 673 with GLOBAL CARRIER

KMW 1440, 1660, 1750, 1760, 1860

KOYKER 1585 & 2585

MASSEY-FERGUSON 950, 955, 960, 965, 975, 985

MC CORMICK L720, L750, L900, L1055, L1060, L1065, L1070

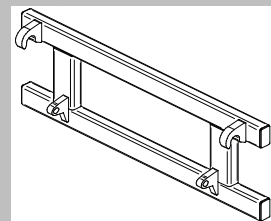

NEW HOLLAND 56LB, 62LB, 72LB, 810TL, 820TL, 830TL, 840TL, 850TL, 860TL, 870TL

STOLL

ZETOR 90, 92, 92HL, 100, 101, 101SL, 102, 102HL, 102SLX, 112SLX, 202, 202SL, 202SLX, 302

Part #	Description	Weight*	Lift Cap.	List Price
5200	Single Tine Bale Stabber with Stabilizer Tines	140	2500	\$ 615.00
5202	Double Tine Bale Stabber - 1 bale capacity	145	4400	\$ 770.00
5205	Pallet Fork - Shaft Style w/roll guard (1 5/8" shaft)	495	5500	\$ 1,600.00
5215-1248	Pallet Fork - Rail Style with 1 1/2" x 48" Tines	420	5200	\$ 1,215.00
5515-00	Single Tine Bale Stabber adapter for Rail Style Pallet Fork	75	2500	\$ 400.00
5515-02	Double Tine Bale Stabber adapter for Rail Style Pallet Fork	100	4400	\$ 533.00
5207	Pallet Fork (Shaft) with Inverted Tine package	610	Fork 5500 Inv 4000	\$ 2,122.00
5208	Pallet Fork (Shaft) with Telescopic Boom -	625	Fork 5500 Boom 4400	\$ 2,312.00
5211	Telescopic Boom	325	Max 7000	\$ 1,044.00
5219	UNI-TACH Skid Steer Attachment Carrier	140	4000	\$ 963.00

GREAT BEND & CASE/IH LOADER OEM REPLACEMENT GRAPPLES

These grapples fit the following loader models only: GB 330, 340, 360, 440, 660, 760, 860, 2136, 2140, 2144, 2157, 2166 - CASE/IH 510, 520, L300 - CASE/IH LX SERIES LX156, LX162, LX162, LX172, LX720, LX730, LX740, LX760, LX770, LX780

Part #	Description	Weight*	Lift Cap.	List Price
GBL-524B	4-TINE GRAPPLE for GREAT BEND & CASE/IH OEM BUCKETS LISTED ABOVE	525		\$ 2,195.00
GBL-525B	5-TINE GRAPPLE for GREAT BEND & CASE/IH OEM BUCKETS LISTED ABOVE	545		\$ 2,355.00

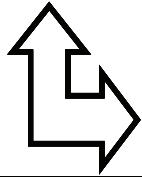

Rock Bucket pricing page 3
Roto-King & 8 ft Sq. Bale Stabbers pricing page 4
Double Round Bale Stabbers & Sur-Grip Bale Grabber pricing page 5
Replacement Buckets pricing page 11 & High Volume Bucket pricing page 12
Manure Buckets & Dozer Blade pricing page 13

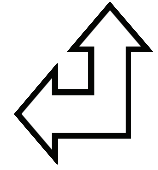

Farmhand F11 Quik-Tach Series Loaders with Standard 60" Wide Dozer Hook Up Includes 235, 236, 248, 258 & 358

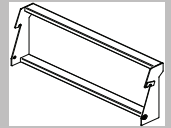

Part #	Description	Weight*	Lift Cap.	List Price
N/A	Single Tine Bale Stabber with Stabilizer Tines	N/A	N/A	N/A
4902	Double Tine Bale Stabber - 1 bale capacity	145	4400	\$ 853.00
4905	Pallet Fork - Shaft Style w/roll guard (1 5/8" shaft)	495	5500	\$ 1,738.00
4915-1248	Pallet Fork - Rail Style with 1 1/2" x 48" Tines	420	5200	\$ 1,427.00
5515-00	Single Tine Bale Stabber adapter for Rail Style Pallet Fork	75	2500	\$ 400.00
5515-02	Double Tine Bale Stabber adapter for Rail Style Pallet Fork	100	4400	\$ 533.00
4907	Pallet Fork (Shaft) with Inverted Tine package	610	Fork 5500 Inv 4000	\$ 2,290.00
4908	Pallet Fork (Shaft) with Telescopic Boom -	625	Fork 5500 Boom 4400	\$ 2,495.00
4911	Telescopic Boom	325	Max 7000	\$ 1,160.00

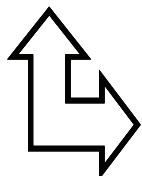

Rock Bucket pricing page 3
Roto-King & 8 ft Sq. Bale Stabbers pricing page 4
Double Round Bale Stabbers & Sur-Grip Bale Grabber pricing page 5
Replacement Buckets pricing page 11 & High Volume Bucket pricing page 12
Manure Buckets & Dozer Blade pricing page 13

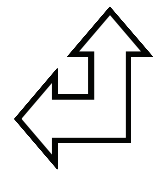

Farmhand XL 490, 590, 662, 740, 940, 1140 & 1340 Quik-Tach Loaders

Hook-up Channel Specs 30 1/2" - 44 1/2" with 7" opening

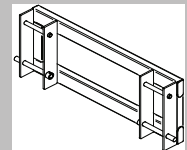

Part #	Description	Weight*	Lift Cap.	List Price
5000	Single Tine Bale Stabber with Stabilizer Tines	195	2500	\$ 660.00
5002	Double Tine Bale Stabber - 1 bale capacity	210	4400	\$ 834.00
5005	Pallet Fork - Shaft Style w/roll guard (1 5/8" shaft)	510	5500	\$ 1,738.00
5015-1248	Pallet Fork - Rail Style with 1 1/2" x 48" Tines	420	5200	\$ 1,427.00
5515-00	Single Tine Bale Stabber adapter for Rail Style Pallet Fork	75	2500	\$ 400.00
5515-02	Double Tine Bale Stabber adapter for Rail Style Pallet Fork	100	4400	\$ 533.00
5007	Pallet Fork (Shaft) with Inverted Tine package	635	Fork 5500 Inv 4000	\$ 2,290.00
5008	Pallet Fork (Shaft) with Telescopic Boom -	645	Fork 5500 Boom 4400	\$ 2,495.00
5011	Telescopic Boom	325	Max 7000	\$ 1,160.00

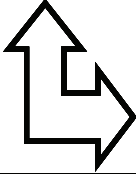
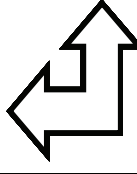
5019	UNI-TACH Skid Steer Attachment Carrier	225	4000	\$ 1,114.00
 Rock Bucket pricing page 3 Roto-King & 8 ft Sq. Bale Stabbers pricing page 4 Double Round Bale Stabbers & Sur-Grip Bale Grabber pricing page 5 Replacement Buckets pricing page 11 & High Volume Bucket pricing page 12 Manure Buckets & Dozer Blade pricing page 13 				

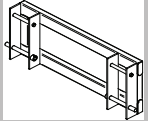
Farmhand XL 945 & 1145 Quik-Tach Series Loaders 				
Hook-up Channel Specs 37 3/4" - 53" with 7 5/8" opening				
Part #	Description	Weight*	Lift Cap.	List Price
5100	Single Tine Bale Stabber with Stabilizer Tines	195	2500	\$ 660.00
5102	Double Tine Bale Stabber - 1 bale capacity	210	4400	\$ 834.00
5105	Pallet Fork - Shaft Style w/roll guard (1 5/8" shaft)	510	5500	\$ 1,738.00
5115-1248	Pallet Fork - Rail Style with 1 1/2" x 48" Tines	420	5200	\$ 1,427.00
5515-00	Single Tine Bale Stabber adapter for Rail Style Pallet Fork	75	2500	\$ 400.00
5515-02	Double Tine Bale Stabber adapter for Rail Style Pallet Fork	100	4400	\$ 533.00
5107	Pallet Fork (Shaft) with Inverted Tine package	635	Fork 5500 Inv 4000	\$ 2,290.00
5108	Pallet Fork (Shaft) with Telescopic Boom -	645	Fork 5500 Boom 4400	\$ 2,495.00
5111	Telescopic Boom	325	Max 7000	\$ 1,160.00
5119	UNI-TACH Skid Steer Attachment Carrier	225	4000	\$ 1,114.00

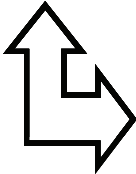
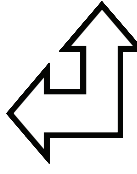
 Rock Bucket pricing page 3 Roto-King & 8 ft Sq. Bale Stabbers pricing page 4 Double Round Bale Stabbers & Sur-Grip Bale Grabber pricing page 5 Replacement Buckets pricing page 11 & High Volume Bucket pricing page 12 Manure Buckets & Dozer Blade pricing page 13 				
---	--	--	--	--

Ford New Holland 7109, 7209, 7309, 7210, 7310, & 7410 				
Quik-Tach Series Loaders 17 3/4" OVERALL VERTICAL OPENING MEASURE FROM TOP OF 2 1/2" OD TUBE TO BOTTOM END OF ANGLE PLATE WIDTH OF QUIK-TACH - 55"				
Part #	Description	Weight*	Lift Cap.	List Price
N/A	Single Tine Bale Stabber with Stabilizer Tines	N/A	N/A	N/A
3402	Double Tine Bale Stabber - 1 bale capacity	210	4400	\$ 910.00
3405	Pallet Fork - Shaft Style w/roll guard (1 5/8" shaft)	510	5500	\$ 1,738.00
3415-1248	Pallet Fork - Rail Style with 1 1/2" x 48" Tines	420	5200	\$ 1,617.00
5515-00	Single Tine Bale Stabber adapter for Rail Style Pallet Fork	75	2500	\$ 400.00
5515-02	Double Tine Bale Stabber adapter for Rail Style Pallet Fork	100	4400	\$ 533.00
3407	Pallet Fork (Shaft) with Inverted Tine package	635	Fork 5500 Inv 4000	\$ 2,290.00
3408	Pallet Fork (Shaft) with Telescopic Boom -	645	Fork 5500 Boom 4400	\$ 2,495.00
3411	Telescopic Boom	325	Max 7000	\$ 1,218.00
3419	UNI-TACH Skid Steer Attachment Carrier	195	4000	\$ 1,236.00

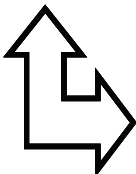
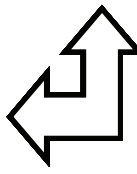
 Rock Bucket pricing page 3 Roto-King & 8 ft Sq. Bale Stabbers pricing page 4 Double Round Bale Stabbers & Sur-Grip Bale Grabber pricing page 5 Replacement Buckets pricing page 11 & High Volume Bucket pricing page 12 Manure Buckets & Dozer Blade pricing page 13 				
---	--	--	--	--

Ford New Holland 72 LA, 7311, 7411, 7511, 7312, 7313, 7314, 7412, 7413, & 7414

Quik-Tach Series Loaders

16" Overall Vertical Opening

MEASURE FROM TOP OF 2 1/2" OD TUBE TO BOTTOM END OF ANGLE PLATE

WIDTH OF QUIK-TACH - 61"

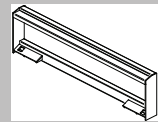

Part #	Description	Weight*	Lift Cap.	List Price
N/A	Single Tine Bale Stabber with Stabilizer Tines	N/A	N/A	N/A
3502	Double Tine Bale Stabber - 1 bale capacity	210	4400	\$ 910.00
3505	Pallet Fork - Shaft Style w/roll guard (1 5/8" shaft)	510	5500	\$ 1,738.00
3515-1248	Pallet Fork - Rail Style with 1 1/2" x 48" Tines	420	5200	\$ 1,617.00
5515-00	Single Tine Bale Stabber adapter for Rail Style Pallet Fork	75	2500	\$ 400.00
5515-02	Double Tine Bale Stabber adapter for Rail Style Pallet Fork	100	4400	\$ 533.00
3507	Pallet Fork (Shaft) with Inverted Tine package	635	Fork 5500 Inv 4000	\$ 2,290.00
3508	Pallet Fork (Shaft) with Telescopic Boom -	645	Fork 5500 Boom 4400	\$ 2,495.00
3511	Telescopic Boom	325	Max 7000	\$ 1,218.00
3519	UNI-TACH Skid Steer Attachment Carrier	195	4000	\$ 1,236.00

Rock Bucket pricing page 3

Roto-King & 8 ft Sq. Bale Stabbers pricing page 4

Double Round Bale Stabbers & Sur-Grip Bale Grabber pricing page 5

Replacement Buckets pricing page 11 & High Volume Bucket pricing page 12

Manure Buckets & Dozer Blade pricing page 13

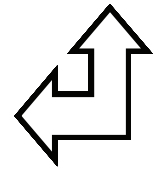
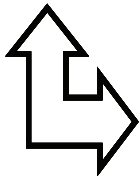

Ford New Holland/ Versatile Bi-Directional Series Loaders

156, 256, 276, 9030, 2360V, 7414V

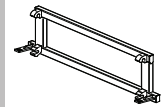

N/A	Single Tine Bale Stabber with Stabilizer Tines	N/A	N/A	N/A
3802	Double Tine Bale Stabber - 1 bale capacity	240	4400	\$ 890.00
3805	Pallet Fork - Shaft Style w/roll guard (1 5/8" shaft)	490	5500	\$ 1,738.00
3815-1248	Pallet Fork - Rail Style with 1 1/2" x 48" Tines	420	5200	\$ 1,617.00
5515-00	Single Tine Bale Stabber adapter for Rail Style Pallet Fork	75	2500	\$ 400.00
5515-02	Double Tine Bale Stabber adapter for Rail Style Pallet Fork	100	4400	\$ 533.00
3807	Pallet Fork (Shaft) with Inverted Tine package	615	Fork 5500 Inv 4000	\$ 2,290.00
3808	Pallet Fork (Shaft) with Telescopic Boom -	640	Fork 5500 Boom 4400	\$ 2,495.00
3811	Telescopic Boom	325	Max 7000	\$ 1,174.00
3819	UNI-TACH Skid Steer Attachment Carrier	195	4000	\$ 1,132.00

Rock Bucket pricing page 3

Roto-King & 8 ft Sq. Bale Stabbers pricing page 4

Double Round Bale Stabbers & Sur-Grip Bale Grabber pricing page 5

Replacement Buckets pricing page 11 & High Volume Bucket pricing page 12

Manure Buckets & Dozer Blade pricing page 13

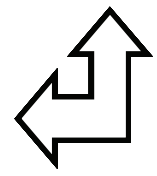
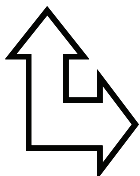

Ford New Holland TV 140, 145 & 6070

Bi-Directional Tractor

With 7614 or 84 LB Loader (7" kick out needed)

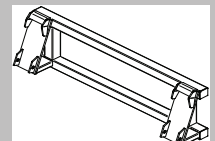

Part #	Description	Weight*	Lift Cap.	List Price
N/A	Single Tine Bale Stabber with Stabilizer Tines	N/A	N/A	N/A

3702	Double Tine Bale Stabber - 1 bale capacity	240	4400	\$ 910.00
3705	Pallet Fork - Shaft Style w/roll guard (1 5/8" shaft)	495	5500	\$ 1,738.00
3715-1248	Pallet Fork - Rail Style with 1 1/2" x 48" Tines	465	5200	\$ 1,617.00
5515-00	Single Tine Bale Stabber adapter for Rail Style Pallet Fork	75	2500	\$ 400.00
5515-02	Double Tine Bale Stabber adapter for Rail Style Pallet Fork	100	4400	\$ 533.00
3707	Pallet Fork (Shaft) with Inverted Tine package	615	Fork 5500 Inv 4000	\$ 2,290.00
3708	Pallet Fork (Shaft) with Telescopic Boom -	640	Fork 5500 Boom 4400	\$ 2,495.00
3711	Telescopic Boom	325	Max 7000	\$ 1,160.00
3719	UNI-TACH Skid Steer Attachment Carrier	155	4000	\$ 1,184.00

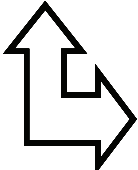
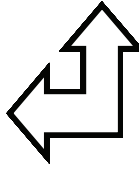
Rock Bucket pricing page 3
Roto-King & 8 ft Sq. Bale Stabbers pricing page 4
Double Round Bale Stabbers & Sur-Grip Bale Grabber pricing page 5
Replacement Buckets pricing page 11 & High Volume Bucket pricing page 12
Manure Buckets & Dozer Blade pricing page 13

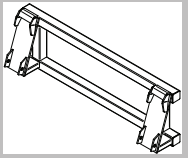
Ford New Holland TV 140, 145 & 6070
Bi-Directional Tractor
82 LB Loader (3" kick out needed)

Part #	Description	Weight*	Lift Cap.	List Price
N/A	Single Tine Bale Stabber with Stabilizer Tines	N/A	N/A	N/A
5302	Double Tine Bale Stabber - 1 bale capacity	240	4400	\$ 910.00
5305	Pallet Fork - Shaft Style w/roll guard (1 5/8" shaft)	495	5500	\$ 1,738.00
5315-1248	Pallet Fork - Rail Style with 1 1/2" x 48" Tines	465	5200	\$ 1,617.00
5515-00	Single Tine Bale Stabber adapter for Rail Style Pallet Fork	75	2500	\$ 400.00
5515-02	Double Tine Bale Stabber adapter for Rail Style Pallet Fork	100	4400	\$ 533.00
5307	Pallet Fork (Shaft) with Inverted Tine package	615	Fork 5500 Inv 4000	\$ 2,290.00
5308	Pallet Fork (Shaft) with Telescopic Boom -	640	Fork 5500 Boom 4400	\$ 2,495.00
5311	Telescopic Boom	325	Max 7000	\$ 1,160.00
5319	UNI-TACH Skid Steer Attachment Carrier	155	4000	\$ 1,184.00

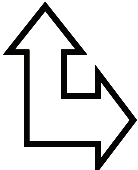
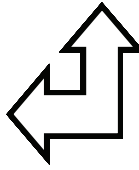
Rock Bucket pricing page 3
Roto-King & 8 ft Sq. Bale Stabbers pricing page 4
Double Round Bale Stabbers & Sur-Grip Bale Grabber pricing page 5
Replacement Buckets pricing page 11 & High Volume Bucket pricing page 12
Manure Buckets & Dozer Blade pricing page 13

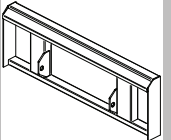
Great Bend 330,340,360, 440, 660, 760, 770, 860,
2136, 2140, 2144, 2157 & 2166, 2169
Bush Hog 3860 Quik-Tach Series Loaders

Part #	Description	Weight*	Lift Cap.	List Price
N/A	Single Tine Bale Stabber with Stabilizer Tines			N/A
3902	Double Tine Bale Stabber - 1 bale capacity	240	4400	\$ 910.00
3905	Pallet Fork - Shaft Style w/roll guard (1 5/8" shaft)	490	5500	\$ 1,738.00
3915-1248	Pallet Fork - Rail Style with 1 1/2" x 48" Tines	420	5200	\$ 1,617.00
5515-00	Single Tine Bale Stabber adapter for Rail Style Pallet Fork	75	2500	\$ 400.00
5515-02	Double Tine Bale Stabber adapter for Rail Style Pallet Fork	100	4400	\$ 533.00
3907	Pallet Fork (Shaft) with Inverted Tine package	615	Fork 5500 Inv 4000	\$ 2,290.00

3908	Pallet Fork (Shaft) with Telescopic Boom -	640	Fork 5500 Boom 4400	\$ 2,495.00
3911	Telescopic Boom	325	Max 7000	\$ 1,219.00
3919	UNI-TACH Skid Steer Attachment Carrier	275	4000	\$ 1,110.00

GREAT BEND & CASE/IH LOADER OEM REPLACEMENT GRAPPLES

These grapples fit the following loader models only: **GB 330, 340, 360, 440, 660, 760, 860, 2136, 2140, 2144, 2157, 2166 - CASE/IH 510, 520, L300 - CASE/IH LX SERIES LX156, LX162, LX162, LX172, LX720, LX730, LX740, LX760, LX770, LX780**

Part #	Description	Weight*	Lift Cap.	List Price
GBL-524B	4-TINE GRAPPLE for GREAT BEND & CASE/IH OEM BUCKETS LISTED ABOVE	525		\$ 2,195.00
GBL-525B	5-TINE GRAPPLE for GREAT BEND & CASE/IH OEM BUCKETS LISTED ABOVE	545		\$ 2,355.00

Rock Bucket pricing page 3
Roto-King & 8 ft Sq. Bale Stabbers pricing page 4
Double Round Bale Stabbers & Sur-Grip Bale Grabber pricing page 5
Replacement Buckets pricing page 11 & High Volume Bucket pricing page 12
Manure Buckets & Dozer Blade pricing page 13

John Deere 145 & 146 with 10" Center Pin On Series Loaders

(If MDS Sur-Lock is on loader, order attachments for 13" Center loaders)

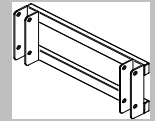

Part #	Description	Weight*	Lift Cap.	List Price
12000	Single Tine Bale Stabber with Stabilizer Tines	140	2500	\$ 660.00
12002	Double Tine Bale Stabber - 1 bale capacity	145	4400	\$ 834.00
12005	Pallet Fork - Shaft Style w/roll guard (1 5/8" shaft)	495	5500	\$ 1,656.00
12015-1248	Pallet Fork - Rail Style with 1 1/2" x 48" Tines	420	5200	\$ 1,352.00
5515-00	Single Tine Bale Stabber adapter for Rail Style Pallet Fork	75	2500	\$ 400.00
5515-02	Double Tine Bale Stabber adapter for Rail Style Pallet Fork	100	4400	\$ 533.00
12007	Pallet Fork (Shaft) with Inverted Tine package	610	Fork 5500 Inv 4000	\$ 2,211.00
12008	Pallet Fork (Shaft) with Telescopic Boom -	625	Fork 5500 Boom 4400	\$ 2,409.00
12011	Telescopic Boom	325	Max 7000	\$ 1,105.00
12019	UNI-TACH Skid Steer Attachment Carrier	120	4000	\$ 903.00

Rock Bucket pricing page 3
Roto-King & 8 ft Sq. Bale Stabbers pricing page 4
Double Round Bale Stabbers & Sur-Grip Bale Grabber pricing page 5
Replacement Buckets pricing page 11 & High Volume Bucket pricing page 12
Manure Buckets & Dozer Blade pricing page 13

SUR-LOCK for John Deere 145 & 146 for 10" Center Pin On Series Loaders

NOTE: Use 13" Pin Center Attachments with this unit

Part #	Description	Weight*	Lift Cap.	List Price
21460	Sur-Lock Quik-Tach System for JD 145 & 146 Loader Models with 10" centers (1" top pin - 1 1/8" bottom pin)	123	N/A	\$ 768.00

John Deere 145, 146, 148 & 158 Pin On Series Loaders for 13" Pin Center Loaders

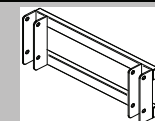

Part #	Description	Weight*	Lift Cap.	List Price
--------	-------------	---------	-----------	------------

22158	Sur-Lock Quik-Tach System for JD 145, 146, 148, & 158 Loader Models with 13" centers (all pins - 1 1/8")	123	N/A	\$ 768.00
2100	Single Tine Bale Stabber with Stabilizer Tines	140	2500	\$ 660.00
2102	Double Tine Bale Stabber - 1 bale capacity	145	4400	\$ 834.00
2105	Pallet Fork - Shaft Style w/roll guard (1 5/8" shaft)	495	5500	\$ 1,656.00
2115-1248	Pallet Fork - Rail Style with 1 1/2" x 48" Tines	420	5200	\$ 1,352.00
5515-00	Single Tine Bale Stabber adapter for Rail Style Pallet Fork	75	2500	\$ 400.00
5515-02	Double Tine Bale Stabber adapter for Rail Style Pallet Fork	100	4400	\$ 533.00
2107	Pallet Fork (Shaft) with Inverted Tine package	610	Fork 5500 Inv 4000	\$ 2,211.00
2108	Pallet Fork (Shaft) with Telescopic Boom -	625	Fork 5500 Boom 4400	\$ 2,409.00
2111	Telescopic Boom	325	Max 7000	\$ 1,160.00
2114	4 x 4 x 4 x 18 x 3/8" Formed Channels with pins	60	N/A	\$ 210.00
2119	UNI-TACH Skid Steer Attachment Carrier	120	4000	\$ 903.00
2814	Attachment carrier Bulkhead which allow JD 640/740 loaders to pickup JD 148/158 loader attachments	295	N/A	\$ 1,252.00

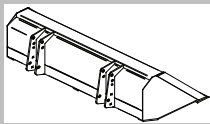

JD 148/158 REPLACEMENT BUCKETS & GRAPPLES

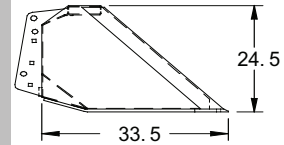

Part #	Description	WT*	Cubic Ft	List Price
2121-5	5 FT Heavy Duty Material Handling Bucket For JD 145/146/148/158 Loaders	530	15	\$ 1,394.00
2121-6	6 FT Heavy Duty Material Handling Bucket For JD 145/146/148/158 Loaders	586	18	\$ 1,520.00
2121-7	7 FT Heavy Duty Material Handling Bucket For JD 145/146/148/158 Loaders	642	21	\$ 1,642.00
2121-8	8 FT Heavy Duty Material Handling Bucket For JD 145/146/148/158 Loaders	698	24	\$ 1,795.00
GF158-4	4-Tine Grapple w/72" Screen	545		\$ 2,070.00
GFT-58	Bolt ON Grapple fork Tine with Hardware (1/2" base plate)	20		\$ 150.00

OPTIONAL 5/8" X 6" DOUBLE BEVEL REVERSIBLE BOLT ON CUTTING EDGE

DBF-586-60	5/8" x 6" x 5 FT Double Bevel Bolt on cutting edge	65		\$ 185.00
DBF-586-72	5/8" x 6" x 6 FT Double Bevel Bolt on cutting edge	76		\$ 200.00
DBF-586-84	5/8" x 6" x 7 FT Double Bevel Bolt on cutting edge	89		\$ 200.00
DBF-586-96	5/8" x 6" x 8 FT Double Bevel Bolt on cutting edge	97		\$ 225.00

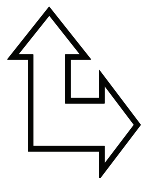

Rock Bucket pricing page 3
Roto-King & 8 ft Sq. Bale Stabbers pricing page 4
Double Round Bale Stabbers & Sur-Grip Bale Grabber pricing page 5
High Volume Bucket pricing page 12
Manure Buckets & Dozer Blade pricing page 13

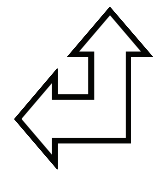

John Deere 168 Pin On Series Loaders

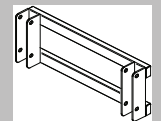

Part #	Description	Weight*	Lift Cap.	List Price
22168	Sur-Lock Quik-Tach System for JD 168 Pin On Series Loaders	135	N/A	\$ 790.00
N/A	Single Tine Bale Stabber with Stabilizer Tines	N/A	N/A	N/A
9302	Double Tine Bale Stabber - 1 bale capacity	145	4400	\$ 834.00
9305	Pallet Fork - Shaft Style w/roll guard (1 5/8" shaft)	495	5500	\$ 1,656.00

9315-1248	Pallet Fork - Rail Style with 1 1/2" x 48" Tines	420	5200	\$ 1,352.00
5515-00	Single Tine Bale Stabber adapter for Rail Style Pallet Fork	75	2500	\$ 400.00
5515-02	Double Tine Bale Stabber adapter for Rail Style Pallet Fork	100	4400	\$ 533.00
9307	Pallet Fork (Shaft) with Inverted Tine package	610	Fork 5500 Inv 4000	\$ 2,211.00
9308	Pallet Fork (Shaft) with Telescopic Boom -	625	Fork 5500 Boom 4400	\$ 2,409.00
9311	Telescopic Boom	325	Max 7000	\$ 1,160.00
2114	4 x 4 x 4 x 18 x 3/8" Formed Channels with pins	60	N/A	\$ 210.00
9319	UNI-TACH Skid Steer Attachment Carrier	120	4000	\$ 910.00

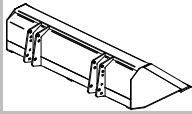

JD 168 REPLACEMENT BUCKETS & GRAPPLES

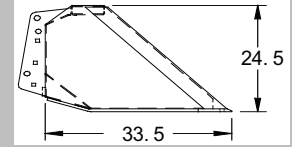

Part #	Description	WT*	Cubic Ft	List Price
9321-6	6 FT Heavy Duty Material Handling Bucket For JD 168 Loaders	500	18	\$ 1,538.00
9321-7	7 FT Heavy Duty Material Handling Bucket For JD 168 Loaders	568	21	\$ 1,642.00
9321-8	8 FT Heavy Duty Material Handling Bucket For JD 168 Loaders	656	24	\$ 1,815.00
GF168-4	4-Tine Grapple with 72" Screen	565		\$ 2,130.00
GFT-58	Bolt ON Grapple fork Tine with Hardware (1/2" base plate)	20		\$ 150.00

OPTIONAL 5/8" X 6" DOUBLE BEVEL REVERSIBLE BOLT ON CUTTING EDGE

DBF-586-72	5/8" x 6" x 6 FT Double Bevel Bolt on cutting edge	76		\$ 200.00
DBF-586-84	5/8" x 6" x 7 FT Double Bevel Bolt on cutting edge	89		\$ 200.00
DBF-586-96	5/8" x 6" x 8 FT Double Bevel Bolt on cutting edge	97		\$ 225.00

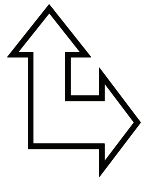

Rock Bucket pricing page 3
Roto-King & 8 ft Sq. Bale Stabbers pricing page 4
Double Round Bale Stabbers & Sur-Grip Bale Grabber pricing page 5
High Volume Bucket pricing page 12
Manure Buckets & Dozer Blade pricing page 13

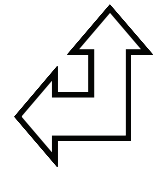

John Deere 175 Pin On Loader

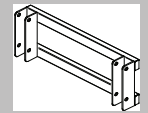

Must specify Pin Size (Top 1 1/8" - 1 1/4" - 1 3/16")

Part #	Description	Weight*	Lift Cap.	List Price
22175	Sur-Lock Quik-Tach System for JD 175 Loaders	125	N/A	\$ 896.00
2200	Single Tine Bale Stabber with Stabilizer Tines	140	2500	\$ 660.00
2202	Double Tine Bale Stabber - 1 bale capacity	145	4400	\$ 834.00
2205	Pallet Fork - Shaft Style w/roll guard (1 5/8" shaft)	495	5500	\$ 1,656.00
2215-1248	Pallet Fork - Rail Style with 1 1/2" x 48" Tines	420	5200	\$ 1,352.00
5515-00	Single Tine Bale Stabber adapter for Rail Style Pallet Fork	75	2500	\$ 400.00
5515-02	Double Tine Bale Stabber adapter for Rail Style Pallet Fork	100	4400	\$ 533.00
2207	Pallet Fork (Shaft) with Inverted Tine package	610	Fork 5500 Inv 4000	\$ 2,211.00
2208	Pallet Fork (Shaft) with Telescopic Boom -	625	Fork 5500 Boom 4400	\$ 2,409.00
2211	Telescopic Boom	325	Max 7000	\$ 1,160.00
2219	UNI-TACH Skid Steer Attachment Carrier	120	4000	\$ 922.00

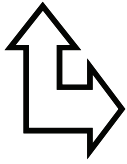

Rock Bucket pricing page 3
Roto-King & 8 ft Sq. Bale Stabbers pricing page 4
Double Round Bale Stabbers & Sur-Grip Bale Grabber pricing page 5
High Volume Bucket pricing page 12
Manure Buckets & Dozer Blade pricing page 13

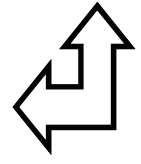

John Deere 240, 245, 260 & 265

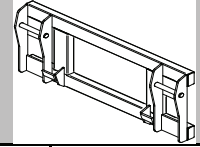

Quik-Tach Series Loaders

Part #	Description	Weight*	Lift Cap.	List Price
2300	Single Tine Bale Stabber with Stabilizer Tines	140	2500	\$ 684.00
2302	Double Tine Bale Stabber - 1 bale capacity	145	4400	\$ 864.00
2305	Pallet Fork - Shaft Style w/roll guard (1 5/8" shaft)	495	5500	\$ 1,712.00
2315-1248	Pallet Fork - Rail Style with 1 1/2" x 48" Tines	420	5200	\$ 1,368.00
5515-00	Single Tine Bale Stabber adapter for Rail Style Pallet Fork	75	2500	\$ 400.00
5515-02	Double Tine Bale Stabber adapter for Rail Style Pallet Fork	100	4400	\$ 533.00
2307	Pallet Fork (Shaft) with Inverted Tine package	610	Fork 5500 Inv 4000	\$ 2,287.00
2308	Pallet Fork (Shaft) with Telescopic Boom -	625	Fork 5500 Boom 4400	\$ 2,492.00
2311	Telescopic Boom	325	Max 7000	\$ 1,144.00
2319	UNI-TACH Skid Steer Attachment Carrier	120	4000	\$ 980.00

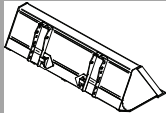

JD 265 REPLACEMENT BUCKETS & GRAPPLES

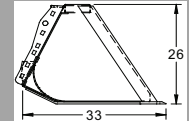

Part #	Description	WT*	Cubic Ft	List Price
2321-6	6 FT Heavy Duty Material Handling Bucket For JD 240/245/260/265 loaders	571	18	\$ 1,590.00
2321-7	7 FT Heavy Duty Material Handling Bucket For JD 240/245/260/265 loaders	615	21	\$ 1,710.00
2321-8	8 FT Heavy Duty Material Handling Bucket For JD 240/245/260/265 loaders	659	24	\$ 1,870.00
GF265-4	4 - Tine Grapple with 72" Screen	546		\$ 2,050.00
GFT-58	Bolt ON Grapple fork Tine with Hardware (1/2" base plate)	20		\$ 150.00

OPTIONAL 5/8" X 6" DOUBLE BEVEL REVERSIBLE BOLT ON CUTTING EDGE

DBF-586-72	5/8" x 6" x 6 FT Double Bevel Bolt on cutting edge	76		\$ 200.00
DBF-586-84	5/8" x 6" x 7 FT Double Bevel Bolt on cutting edge	89		\$ 200.00
DBF-586-96	5/8" x 6" x 8 FT Double Bevel Bolt on cutting edge	97		\$ 225.00

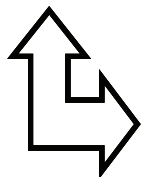

Rock Bucket pricing page 3
Roto-King & 8 ft Sq. Bale Stabbers pricing page 4
Double Round Bale Stabbers & Sur-Grip Bale Grabber pricing page 5
High Volume Bucket pricing page 12
Manure Buckets & Dozer Blade pricing page 13

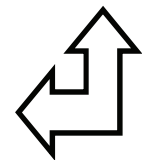

John Deere 280 Loader

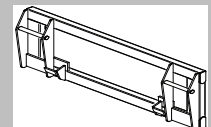

Part #	Description	Weight*	Lift Cap.	List Price
2400	Single Tine Bale Stabber with Stabilizer Tines	195	2500	\$ 684.00

2402	Double Tine Bale Stabber - 1 bale capacity	210	4400	\$ 864.00
2405	Pallet Fork - Shaft Style w/roll guard (1 5/8" shaft)	510	5500	\$ 1,758.00
2415-1248	Pallet Fork - Rail Style with 1 1/2" x 48" Tines	465	5200	\$ 1,581.00
5515-00	Single Tine Bale Stabber adapter for Rail Style Pallet Fork	75	2500	\$ 400.00
5515-02	Double Tine Bale Stabber adapter for Rail Style Pallet Fork	100	4400	\$ 533.00
2407	Pallet Fork (Shaft) with Inverted Tine package	635	Fork 5500 Inv 4000	\$ 2,290.00
2408	Pallet Fork (Shaft) with Telescopic Boom -	645	Fork 5500 Boom 4400	\$ 2,494.00
2411	Telescopic Boom	325	Max 7000	\$ 1,160.00
2419	UNI-TACH Skid Steer Attachment Carrier	250	4000	\$ 1,125.00

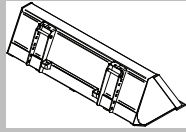

JD 280 REPLACEMENT BUCKETS & GRAPPLES

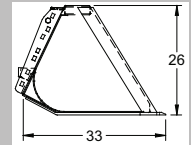

Part #	Description	WT*	Cubic Ft	List Price
2421-7	7 FT Heavy Duty Material Handling Bucket For JD 280 loaders	615	21	\$ 1,725.00
2421-8	8 FT Heavy Duty Material Handling Bucket For JD 280 loaders	659	24	\$ 1,995.00
GF280-4	4 - Tine Grapple with 72" Screen	546		\$ 2,075.00
GFT-58	Bolt ON Grapple fork Tine with Hardware (1/2" base plate)	20		\$ 150.00

OPTIONAL 5/8" X 6" DOUBLE BEVEL REVERSIBLE BOLT ON CUTTING EDGE

DBF-586-84	5/8" x 6" x 7 FT Double Bevel Bolt on cutting edge	89		\$ 200.00
DBF-586-96	5/8" x 6" x 8 FT Double Bevel Bolt on cutting edge	97		\$ 225.00

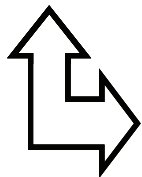

Rock Bucket pricing page 3

Roto-King & 8 ft Sq. Bale Stabbers pricing page 4

Double Round Bale Stabbers & Sur-Grip Bale Grabber pricing page 5

High Volume Bucket pricing page 12

Manure Buckets & Dozer Blade pricing page 13

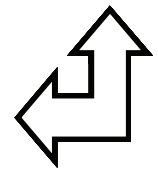

John Deere 200X, 200CX, 300X, 300CX, 400, 400X, 500, 500X Quik-Tach Series Loaders

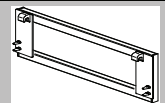

Part #	Description	Weight*	Lift Cap.	List Price
2600	Single Tine Bale Stabber with Stabilizer Tines	140	2500	\$ 612.00
2602	Double Tine Bale Stabber - 1 bale capacity	145	4400	\$ 767.00
2605	Pallet Fork - Shaft Style w/roll guard (1 5/8" shaft)	495	5500	\$ 1,595.00

2615-1442	Pallet Fork - Rail Style with 1 1/4" x 42" Tines	400	4000	\$ 975.00
2615-1446	Pallet Fork - Rail Style with 1 1/4" x 46" Tines	400	4000	\$ 975.00
2615-1448	Pallet Fork - Rail Style with 1 1/4" x 48" Tines	400	4000	\$ 975.00

2615-1242	Pallet Fork - Rail Style with 1 1/2" x 42" Tines	420	5200	\$ 1,095.00
2615-1246	Pallet Fork - Rail Style with 1 1/2" x 46" Tines	420	5200	\$ 1,095.00
2615-1248	Pallet Fork - Rail Style with 1 1/2" x 48" Tines	420	5200	\$ 1,095.00

2615E-42	Pallet Fork - Economy Rail Style with 42" Full Tapered Tines - for JD 200, 300, & 400 series Loaders	390	2800	\$ 835.00
2615E-46	Pallet Fork - Economy Rail Style with 46" Full Tapered Tines - for JD 200, 300, & 400 series Loaders	400	2800	\$ 865.00

5515-00	Single Tine Bale Stabber adapter for Rail Style Pallet Fork	75	2500	\$ 400.00
5515-02	Double Tine Bale Stabber adapter for Rail Style Pallet Fork	100	4400	\$ 533.00

2615C-36	Pallet Fork - Compact with 36" Tubular Tines - JD 200 & 300 series ONLY	265	1800	\$ 782.00
2615C-42	Pallet Fork - Compact with 42" Tubular Tines - JD 200 & 300 series ONLY	270	1800	\$ 813.00

2607	Pallet Fork (Shaft) with Inverted Tine package	610	Fork 5500 Inv 4000	\$ 2,261.00
2608	Pallet Fork (Shaft) with Telescopic Boom -	625	Fork 5500 Boom 4400	\$ 2,463.00
2611	Telescopic Boom	325	Max 7000	\$ 1,106.00
2619	UNI-TACH Skid Steer Attachment Carrier	130	4000	\$ 935.00

JD 400/500 REPLACEMENT BUCKETS & GRAPPLES

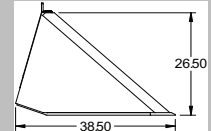

Part #	Description	WT*	Cubic Ft	List Price
2621-5	5 FT Heavy Duty Material Handling Bucket For JD 400, 500 Series loaders	540	15	\$ 1,221.00
2621-6	6 FT Heavy Duty Material Handling Bucket For JD 400, 500 Series loaders	550	18	\$ 1,275.00
2621-65	6 1/2 FT Heavy Duty Material Handling Bucket For JD 400, 500 Series loaders	590	21	\$ 1,325.00
2621-7	7 FT Heavy Duty Material Handling Bucket For JD 400, 500 Series loaders	630	24	\$ 1,392.00
GF24-4	4 - Tine Fixed Single Cylinder Grapple	192		\$ 848.00

OPTIONAL 5/8" X 6" DOUBLE BEVEL REVERSIBLE BOLT ON CUTTING EDGE

DBF-586-60	5/8" x 6" x 5 FT Double Bevel Bolt on cutting edge	65		\$ 185.00
DBF-586-72	5/8" x 6" x 6 FT Double Bevel Bolt on cutting edge	76		\$ 200.00
DBF-586-78	5/8" x 6" x 6.5 FT Double Bevel Bolt on cutting edge	83		\$ 200.00
DBF-586-84	5/8" x 6" x 7 FT Double Bevel Bolt on cutting edge	89		\$ 200.00

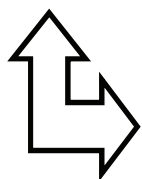

Rock Bucket pricing page 3
Roto-King & 8 ft Sq. Bale Stabbers pricing page 4
Double Round Bale Stabbers & Sur-Grip Bale Grabber pricing page 5
High Volume Bucket pricing page 12
Manure Buckets & Dozer Blade pricing page 13

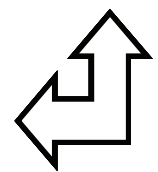

John Deere 600/700 Pin On Series Loaders

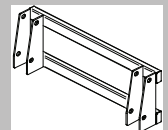

Part #	Description	Weight*	Lift Cap.	List Price
36700	Sur-Lock Quik-Tach System for JD 620, 625, 720, & 725 Loaders w/o Factory Quick Attach (1 3/8" x 13" Center Units ONLY)	148	N/A	\$ 829.00
2700	Single Tine Bale Stabber with Stabilizer Tines	140	25	\$ 684.00
2702	Double Tine Bale Stabber - 1 bale capacity	145	4400	\$ 864.00
2705	Pallet Fork - Shaft Style w/roll guard (1 5/8" shaft)	495	5500	\$ 1,738.00
2715-1248	Pallet Fork - Rail Style with 1 1/2" x 48" Tines	420	5200	\$ 1,396.00
5515-00	Single Tine Bale Stabber adapter for Rail Style Pallet Fork	75	2500	\$ 400.00
5515-02	Double Tine Bale Stabber adapter for Rail Style Pallet Fork	100	4400	\$ 533.00

2707	Pallet Fork (Shaft) with Inverted Tine package	610	Fork 5500 Inv 4000	\$ 2,290.00
2708	Pallet Fork (Shaft) with Telescopic Boom -	625	Fork 5500 Boom 4400	\$ 2,495.00
2711	Telescopic Boom	325	Max 7000	\$ 1,160.00
2719	UNI-TACH Skid Steer Attachment Carrier	145	4000	\$ 1,090.00

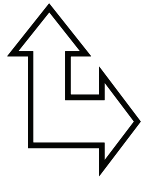

Rock Bucket pricing page 3
Roto-King & 8 ft Sq. Bale Stabbers pricing page 4
Double Round Bale Stabbers & Sur-Grip Bale Grabber pricing page 5
Replacement Buckets pricing page 11 & High Volume Bucket pricing page 12
Manure Buckets & Dozer Blade pricing page 13

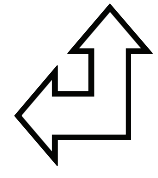

John Deere 552, 553, 563 & 673 Quik-Tach Series Loaders

Loaders with GLOBAL CARRIERS(Euro) see PAGE 28

Loaders with UNIVERSAL SKID STEER STYLE Hookup see PAGE 45

Loaders with JD 600 STYLE CARRIER QUIK-TACH See JD 740 in following section

John Deere 640, 740, 741 & 746

John Deere Classic Quik-Tach Series

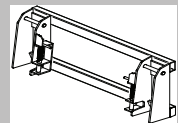

Part #	Description	Weight*	Lift Cap.	List Price
2800	Single Tine Bale Stabber with Stabilizer Tines	195	2500	\$ 817.00
2802	Double Tine Bale Stabber - 1 bale capacity	210	4400	\$ 961.00
2805	Pallet Fork - Shaft Style w/roll guard (1 5/8" shaft)	510	5500	\$ 1,661.00
2815-1248	Pallet Fork - Rail Style with 1 1/2" x 48" Tines	465	5200	\$ 1,295.00
5515-00	Single Tine Bale Stabber adapter for Rail Style Pallet Fork	75	2500	\$ 400.00
5515-02	Double Tine Bale Stabber adapter for Rail Style Pallet Fork	100	4400	\$ 533.00
2807	Pallet Fork (Shaft) with Inverted Tine package	635	Fork 5500 Inv 4000	\$ 2,206.00
2808	Pallet Fork (Shaft) with Telescopic Boom -	645	Fork 5500 Boom 4400	\$ 2,394.00
2811	Telescopic Boom	325	Max 7000	\$ 1,128.00
2814	Attachment carrier Bulkhead which allow JD 640/740 loaders to pickup JD 148/158 loader attachments	295	N/A	\$ 1,252.00
2819	UNI-TACH Skid Steer Attachment Carrier	175	4000	\$ 1,072.00
2820-4	Weld On mounting Brackets - 2 pc	84	N/A	\$ 478.00

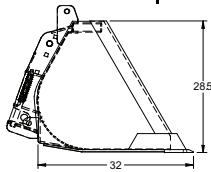

JOHN DEERE BUCKETS

GRAPPLES

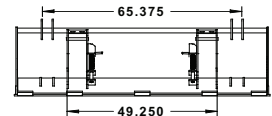
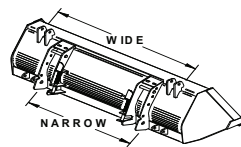

Part #	JD REPLACEMENT BUCKETS & GRAPPLES	WT*	Cubic Ft	List Price
2821-6	6 FT Heavy Duty Material Handling Bucket For JD 600 700 series loaders with Classic QT	655	18	\$ 1,425.00
2821-7	7 FT Heavy Duty Material Handling Bucket For JD 600 700 series loaders with Classic QT	711	21	\$ 1,595.00
2821-8	8 FT Heavy Duty Material Handling Bucket For JD 600 700 series loaders with Classic QT	767	24	\$ 1,845.00
GF52-4G	4-tine Wide Stance grapple - see illustration above	549		\$ 2,075.00
GF52-5G	5-tine Wide Stance grapple - see illustration above	575		\$ 2,375.00

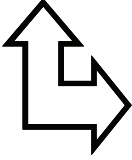
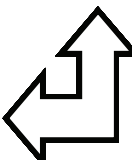
GF740N-4	4-tine Narrow grapple - see illustration above	563		\$ 2,075.00
GF740N-5	5-tine Narrow grapple - see illustration above	589		\$ 2,375.00
OPTIONAL 5/8" X 6" DOUBLE BEVEL REVERSIBLE BOLT ON CUTTING EDGE				
DBF-586-72	5/8" x 6" x 6 FT Double Bevel Bolt on cutting edge	76		\$ 200.00
DBF-586-84	5/8" x 6" x 7 FT Double Bevel Bolt on cutting edge	89		\$ 200.00
DBF-586-96	5/8" x 6" x 8 FT Double Bevel Bolt on cutting edge	97		\$ 225.00
 <p style="text-align: center;"> Rock Bucket pricing page 3 Roto-King & 8 ft Sq. Bale Stabbers pricing page 4 Double Round Bale Stabbers & Sur-Grip Bale Grabber pricing page 5 High Volume Bucket pricing page 12 Manure Buckets & Dozer Blade pricing page 13 </p> 				

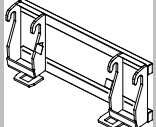
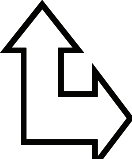
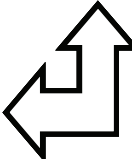
<h2 style="margin: 0;">John Deere 840 & 843 Quik-Tach Series Loader</h2> 				
Part #	Description	Weight*	Lift Cap.	List Price
N/A	Single Tine Bale Stabber with Stabilizer Tines	N/A	N/A	N/A
2902	Double Tine Bale Stabber - 1 bale capacity	260	4400	\$ 1,025.00
2905	Pallet Fork - Shaft Style w/roll guard (1 5/8" shaft)	560	5500	\$ 1,738.00
2915-1248	Pallet Fork - Rail Style with 1 1/2" x 48" Tines	465	5200	\$ 1,617.00
5515-00	Single Tine Bale Stabber adapter for Rail Style Pallet Fork	75	2500	\$ 400.00
5515-02	Double Tine Bale Stabber adapter for Rail Style Pallet Fork	100	4400	\$ 533.00
2907	Pallet Fork (Shaft) with Inverted Tine package	685	Fork 5500 Inv 4000	\$ 2,290.00
2908	Pallet Fork (Shaft) with Telescopic Boom -	695	Fork 5500 Boom 4400	\$ 2,495.00
2911	Telescopic Boom	325	Max 7000	\$ 1,160.00
2919	UNI-TACH Skid Steer Attachment Carrier	200	4000	\$ 1,096.00
2920-4	Weld On mounting Brackets - 2 pc	114	N/A	\$ 522.00
 <p style="text-align: center;"> Rock Bucket pricing page 3 Roto-King & 8 ft Sq. Bale Stabbers pricing page 4 Double Round Bale Stabbers & Sur-Grip Bale Grabber pricing page 5 Replacement Buckets pricing page 11 & High Volume Bucket pricing page 12 Manure Buckets & Dozer Blade pricing page 13 </p> 				

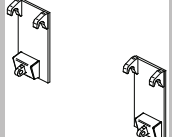
<h2 style="margin: 0;">John Deere H480 Quik-Tach Series Loader</h2> 				
Part #	Description	Weight*	Lift Cap.	List Price
N/A	Single Tine Bale Stabber with Stabilizer Tines	N/A	N/A	N/A
12502	Double Tine Bale Stabber - 1 bale capacity	260	4400	\$ 1,125.00
12505	Pallet Fork - Shaft Style w/roll guard (1 5/8" shaft)	560	5500	\$ 1,838.00
12515-1248	Pallet Fork - Rail Style with 1 1/2" x 48" Tines	465	5200	\$ 1,717.00
5515-00	Single Tine Bale Stabber adapter for Rail Style Pallet Fork	75	2500	\$ 400.00
5515-02	Double Tine Bale Stabber adapter for Rail Style Pallet Fork	100	4400	\$ 533.00
12507	Pallet Fork (Shaft) with Inverted Tine package	685	Fork 5500 Inv 4000	\$ 2,390.00
12508	Pallet Fork (Shaft) with Telescopic Boom -	695	Fork 5500 Boom 4400	\$ 2,595.00
12511	Telescopic Boom	325	Max 7000	\$ 1,260.00

12519	UNI-TACH Skid Steer Attachment Carrier	200	4000	\$ 1,196.00
12520-4	Weld On mounting Brackets - 2 pc	200	N/A	\$ 685.00

Rock Bucket pricing page 3
Roto-King & 8 ft Sq. Bale Stabbers pricing page 4
Double Round Bale Stabbers & Sur-Grip Bale Grabber pricing page 5
Replacement Buckets pricing page 11 & High Volume Bucket pricing page 12
Manure Buckets & Dozer Blade pricing page 13

John Deere 48/58 Single Cylinder Loaders

Must specify Pin Size (Top 1 1/8" - 1 1/4" - 1 1/2" Bottom 1 1/4")

Part #	Description	Weight*	Lift Cap.	List Price
3002	Double Tine Bale Stabber	175	4400	\$ 982.00
3005	Pallet Fork - Shaft Style w/roll guard (1 5/8" shaft)	510	5500	\$ 1,913.00
3015-1248	Pallet Fork - Rail Style with 1 1/2" x 48" Tines	465	5200	\$ 1,617.00
5515-00	Single Tine Bale Stabber adapter for Rail Style Pallet Fork	75	2500	\$ 400.00
5515-02	Double Tine Bale Stabber adapter for Rail Style Pallet Fork	100	4400	\$ 533.00
3019	UNI-TACH Skid Steer Attachment Carrier	120	4000	\$ 1,038.00

Rock Bucket pricing page 3
Roto-King & 8 ft Sq. Bale Stabbers pricing page 4
Double Round Bale Stabbers & Sur-Grip Bale Grabber pricing page 5
Replacement Buckets pricing page 11 & High Volume Bucket pricing page 12
Manure Buckets & Dozer Blade pricing page 13

KD 5000, 5500, 6400, & 7400 Loaders with 1 3/8" Pins 13" On Center

Part #	Description	Weight*	Lift Cap.	List Price
36750	Sur-Lock Quik-Tach System for KD Loaders with 1 3/8" x 13" Center Units ONLY	148	N/A	\$ 829.00
11200	Single Tine Bale Stabber with Stabilizer Tines	140	2500	\$ 684.00
11202	Double Tine Bale Stabber - 1 bale capacity	145	4400	\$ 864.00
11205	Pallet Fork - Shaft Style w/roll guard (1 5/8" shaft)	495	5500	\$ 1,738.00
11215-1248	Pallet Fork - Rail Style with 1 1/2" x 48" Tines	420	5200	\$ 1,427.00
5515-00	Single Tine Bale Stabber adapter for Rail Style Pallet Fork	75	2500	\$ 400.00
5515-02	Double Tine Bale Stabber adapter for Rail Style Pallet Fork	100	4400	\$ 533.00
11207	Pallet Fork (Shaft) with Inverted Tine package	610	Fork 5500 Inv 4000	\$ 2,290.00
11208	Pallet Fork (Shaft) with Telescopic Boom -	625	Fork 5500 Boom 4400	\$ 2,495.00
11211	Telescopic Boom	325	Max 7000	\$ 1,160.00
11219	UNI-TACH Skid Steer Attachment Carrier	145	4000	\$ 1,090.00

Rock Bucket pricing page 3
Roto-King & 8 ft Sq. Bale Stabbers pricing page 4
Double Round Bale Stabbers & Sur-Grip Bale Grabber pricing page 5
Replacement Buckets pricing page 11 & High Volume Bucket pricing page 12
Manure Buckets & Dozer Blade pricing page 13

Koyker 180, 185, 190, 195, 210, 220, 235 & 245

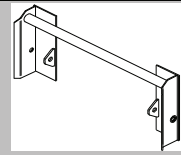

with Koyker Quik-Tach System

Part #	Description	Weight*	Lift Cap.	List Price
11100	Single Tine Bale Stabber with Stabilizer Tines	140	2500	\$ 662.00
11102	Double Tine Bale Stabber - 1 bale capacity	145	4400	\$ 817.00
11105	Pallet Fork - Shaft Style w/roll guard (1 5/8" shaft)	495	5500	\$ 1,738.00
11115-1248	Pallet Fork - Rail Style with 1 1/2" x 48" Tines	420	5200	\$ 1,346.00
5515-00	Single Tine Bale Stabber adapter for Rail Style Pallet Fork	75	2500	\$ 400.00
5515-02	Double Tine Bale Stabber adapter for Rail Style Pallet Fork	100	4400	\$ 533.00
11107	Pallet Fork (Shaft) with Inverted Tine package	610	Fork 5500 Inv 4000	\$ 2,290.00
11108	Pallet Fork (Shaft) with Telescopic Boom -	625	Fork 5500 Boom 4400	\$ 2,495.00
11111	Telescopic Boom	325	Max 7000	\$ 1,160.00
11119	UNI-TACH Skid Steer Attachment Carrier	145	4000	\$ 985.00

Rock Bucket pricing page 3

Roto-King & 8 ft Sq. Bale Stabbers pricing page 4

Double Round Bale Stabbers & Sur-Grip Bale Grabber pricing page 5

Replacement Buckets pricing page 11 & High Volume Bucket pricing page 12

Manure Buckets & Dozer Blade pricing page 13

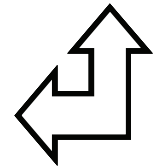
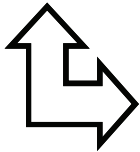

Koyker 180, 185, 190, 195, 210, 220, 235 & 245

with Universal Skid Steer Style Hookup

See page 45

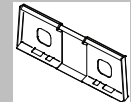

Koyker 310, 345, 385, 445, 510, 545, 565, 585, 600 & 645

with Koyker Quik-Tach System

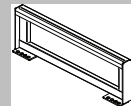

Part #	Description	Weight*	Lift Cap.	List Price
11000	Single Tine Bale Stabber with Stabilizer Tines	140	2500	\$ 592.00
11002	Double Tine Bale Stabber - 1 bale capacity	145	4400	\$ 768.00
11005	Pallet Fork - Shaft Style w/roll guard (1 5/8" shaft)	495	5500	\$ 1,630.00
11015-1248	Pallet Fork - Rail Style with 1 1/2" x 48" Tines	420	5200	\$ 1,352.00
5515-00	Single Tine Bale Stabber adapter for Rail Style Pallet Fork	75	2500	\$ 400.00
5515-02	Double Tine Bale Stabber adapter for Rail Style Pallet Fork	100	4400	\$ 533.00
11007	Pallet Fork (Shaft) with Inverted Tine package	610	Fork 5500 Inv 4000	\$ 2,261.00
11008	Pallet Fork (Shaft) with Telescopic Boom -	625	Fork 5500 Boom 4400	\$ 2,463.00
11011	Telescopic Boom	325	Max 7000	\$ 1,160.00
11019	UNI-TACH Skid Steer Attachment Carrier	145	4000	\$ 985.00

Rock Bucket pricing page 3

Roto-King & 8 ft Sq. Bale Stabbers pricing page 4

Double Round Bale Stabbers & Sur-Grip Bale Grabber pricing page 5

Replacement Buckets pricing page 11 & High Volume Bucket pricing page 12

Manure Buckets & Dozer Blade pricing page 13

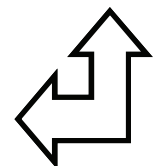
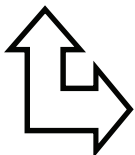

Kubota LA39, LA513, LA723, LA853, LA1163, LA1153, LA1301 & LA1601

with Universal Skid Steer Style Hook up

See page 45

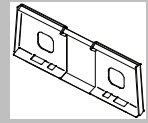

Kubota LA1251

Quik-Tach Series Loaders

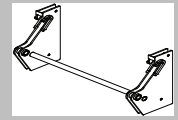

Part #	Description	Weight*	Lift Cap.	List Price
N/A	Single Tine Bale Stabber with Stabilizer Tines			N/A
9002	Double Tine Bale Stabber - 1 bale capacity	145	4400	\$ 864.00
9005	Pallet Fork - Shaft Style w/roll guard (1 5/8" shaft)	495	5500	\$ 1,738.00
9015-1248	Pallet Fork - Rail Style with 1 1/2" x 48" Tines	420	5200	\$ 1,643.00
5515-00	Single Tine Bale Stabber adapter for Rail Style Pallet Fork	75	2500	\$ 400.00
5515-02	Double Tine Bale Stabber adapter for Rail Style Pallet Fork	100	4400	\$ 533.00
9007	Pallet Fork (Shaft) with Inverted Tine package	610	Fork 5500 Inv 4000	\$ 2,290.00
9008	Pallet Fork (Shaft) with Telescopic Boom -	625	Fork 5500 Boom 4400	\$ 2,495.00
9011	Telescopic Boom	325	Max 7000	\$ 1,160.00
9019	UNI-TACH Skid Steer Attachment Carrier	125	4000	\$ 933.00

Rock Bucket pricing page 3

Roto-King & 8 ft Sq. Bale Stabbers pricing page 4

Double Round Bale Stabbers & Sur-Grip Bale Grabber pricing page 5

Replacement Buckets pricing page 11 & High Volume Bucket pricing page 12

Manure Buckets & Dozer Blade pricing page 13

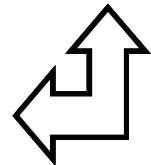
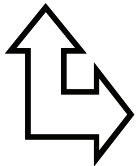

Massey-Ferguson 950, 955, 960, 965, 975, 985

SEE "EURO" HOOK UP PAGE 28

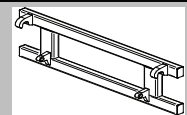

Massey-Ferguson 1040, 1050, 1060, 1070 & 1080, DL 280

SEE AGCO FL300 PAGE 19

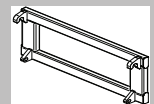

Massey-Ferguson 1090 "New Style" Quik-Tach Loaders

SEE AGCO FL600 PAGE 20

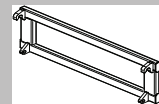

McCormick "L" Series Quik-Tach Loaders

L720, L750, L900, L1060, L1065, L1070

SEE "EURO" HOOK UP PAGE 28

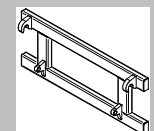

Miller M12-P12 Quik-Tach Series Loaders ONLY

Part #	Description	Weight*	Lift Cap.	List Price
N/A	Single Tine Bale Stabber with Stabilizer Tines			N/A

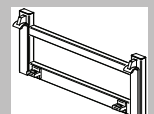

5402	Double Tine Bale Stabber - 1 bale capacity	210	4400	\$ 1,044.00
5405	Pallet Fork - Shaft Style w/roll guard (1 5/8" shaft)	510	5500	\$ 1,892.00
5415-1248	Pallet Fork - Rail Style with 1 1/2" x 48" Tines	465	5200	\$ 1,786.00
5515-00	Single Tine Bale Stabber adapter for Rail Style Pallet Fork	75	2500	\$ 400.00
5515-02	Double Tine Bale Stabber adapter for Rail Style Pallet Fork	100	4400	\$ 533.00
5407	Pallet Fork (Shaft) with Inverted Tine package	635	Fork 5500 Inv 4000	\$ 2,438.00
5408	Pallet Fork (Shaft) with Telescopic Boom -	645	Fork 5500 Boom 4400	\$ 2,645.00
5411	Telescopic Boom	325	Max 7000	\$ 1,351.00
5419	UNI-TACH Skid Steer Attachment Carrier	170	4000	\$ 1,100.00

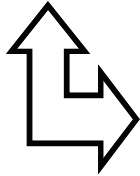

Rock Bucket pricing page 3
Roto-King & 8 ft Sq. Bale Stabbers pricing page 4
Double Round Bale Stabbers & Sur-Grip Bale Grabber pricing page 5
Replacement Buckets pricing page 11 & High Volume Bucket pricing page 12
Manure Buckets & Dozer Blade pricing page 13

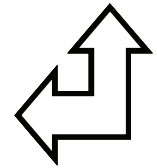

Miller PL2X, PL2 JR, PL2, GP25, & GL25

Quik-Tach Series Loaders

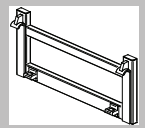

Part #	Description	Weight*	Lift Cap.	List Price
N/A	Single Tine Bale Stabber with Stabilizer Tines			N/A
6502	Double Tine Bale Stabber - 1 bale capacity	210	4400	\$ 1,044.00
6505	Pallet Fork - Shaft Style w/roll guard (1 5/8" shaft)	510	5500	\$ 1,892.00
6515-1248	Pallet Fork - Rail Style with 1 1/2" x 48" Tines	465	5200	\$ 1,786.00
5515-00	Single Tine Bale Stabber adapter for Rail Style Pallet Fork	75	2500	\$ 400.00
5515-02	Double Tine Bale Stabber adapter for Rail Style Pallet Fork	100	4400	\$ 533.00
6507	Pallet Fork (Shaft) with Inverted Tine package	635	Fork 5500 Inv 4000	\$ 2,438.00
6508	Pallet Fork (Shaft) with Telescopic Boom -	645	Fork 5500 Boom 4400	\$ 2,645.00
6511	Telescopic Boom	325	Max 7000	\$ 1,351.00
6519	UNI-TACH Skid Steer Attachment Carrier	210	N/A	\$ 1,100.00

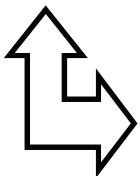

Rock Bucket pricing page 3
Roto-King & 8 ft Sq. Bale Stabbers pricing page 4
Double Round Bale Stabbers & Sur-Grip Bale Grabber pricing page 5
Replacement Buckets pricing page 11 & High Volume Bucket pricing page 12
Manure Buckets & Dozer Blade pricing page 13

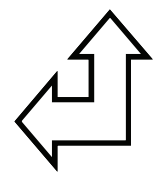

Miller PL3, PL4, PL5, GL30, GP30 & GP35

Quik-Tach Series Loaders

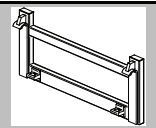

Part #	Description	Weight*	Lift Cap.	List Price
N/A	Single Tine Bale Stabber with Stabilizer Tines			N/A
6902	Double Tine Bale Stabber - 1 bale capacity	210	4400	\$ 1,044.00
6905	Pallet Fork - Shaft Style w/roll guard (1 5/8" shaft)	510	5500	\$ 1,892.00
6915-1248	Pallet Fork - Rail Style with 1 1/2" x 48" Tines	465	5200	\$ 1,786.00
5515-00	Single Tine Bale Stabber adapter for Rail Style Pallet Fork	75	2500	\$ 400.00
5515-02	Double Tine Bale Stabber adapter for Rail Style Pallet Fork	100	4400	\$ 533.00
6907	Pallet Fork (Shaft) with Inverted Tine package	635	Fork 5500 Inv 4000	\$ 2,438.00
6908	Pallet Fork (Shaft) with Telescopic Boom -	645	Fork 5500 Boom 4400	\$ 2,645.00

6911	Telescopic Boom	325	Max 7000	\$ 1,351.00
------	-----------------	-----	----------	-------------

Rock Bucket pricing page 3
Roto-King & 8 ft Sq. Bale Stabbers pricing page 4
Double Round Bale Stabbers & Sur-Grip Bale Grabber pricing page 5
Replacement Buckets pricing page 11 & High Volume Bucket pricing page 12
Manure Buckets & Dozer Blade pricing page 13

Miller G15 & G20 Quik-Tach Series Loaders				
--	--	--	--	--

Part #	Description	Weight*	Lift Cap.	List Price
9700	Single Tine Bale Stabber with Stabilizer Tines	195	2500	\$ 870.00
9702	Double Tine Bale Stabber - 1 bale capacity	210	4400	\$ 1,044.00
9715-1448	Pallet Fork - Rail Style with 1 1/2" x 48" Tines	465	5200	\$ 1,786.00
5515-00	Single Tine Bale Stabber adapter for Rail Style Pallet Fork	75	2500	\$ 400.00
5515-02	Double Tine Bale Stabber adapter for Rail Style Pallet Fork	100	4400	\$ 533.00

Rock Bucket pricing page 3
Roto-King & 8 ft Sq. Bale Stabbers pricing page 4
Double Round Bale Stabbers & Sur-Grip Bale Grabber pricing page 5
Replacement Buckets pricing page 11 & High Volume Bucket pricing page 12
Manure Buckets & Dozer Blade pricing page 13

<p>New Holland 14LA, 16LA, 17LA, 18LA, 32LA, 33LA, 52LA, 46LB, 52LB, 230TL, 240TL, 250TL, 260TL, & 270TL Series Loaders with Universal Skid Steer Style Hook-up See Page 45</p>	
--	--

<p>New Holland 56LB, 62LB, 72LB, 810TL, 820TL, 830TL, 840TL, 850TL, 860TL & 870TL Series Loaders SEE "EURO" HOOK UP PAGE 28</p>	
--	--

<p>New Holland 92LB Series Loaders See Case IH LX 192 page 26</p>
--

Skid Steer for 1995 and Newer and Tractor Loaders				
--	--	--	--	--

Part #	Description	Weight*	Lift Cap.	List Price
5500	Single Tine Bale Stabber with Stabilizer Tines	140	2500	\$ 632.00
5502	Double Tine Bale Stabber - 1 bale capacity	145	4400	\$ 798.00
5505	Pallet Fork - Shaft Style w/roll guard (1 5/8" shaft)	495	5500	\$ 1,690.00
5505WT	Pallet Fork - Walk Thru Shaft Style w/roll guard (1 5/8" shaft)	495	5500	\$ 1,690.00

5515-1442	Pallet Fork - Rail Style with 1 1/4" x 42" Tines	450	4000	\$ 1,014.00
5515-1446	Pallet Fork - Rail Style with 1 1/4" x 46" Tines	450	4000	\$ 1,014.00
5515-1448	Pallet Fork - Rail Style with 1 1/4" x 48" Tines	450	4000	\$ 1,014.00
5515WT-1442	Pallet Fork - Walk Thru Rail Style with 1 1/4" x 42" Tines	450	4000	\$ 1,014.00
5515WT-1446	Pallet Fork - Walk Thru Rail Style with 1 1/4" x 46" Tines	450	4000	\$ 1,014.00

5515WT-1448	Pallet Fork - Walk Thru Rail Style with 1 1/4" x 48" Tines	450	4000	\$ 1,014.00
-------------	---	-----	------	-------------

5515-1242	Pallet Fork - Rail Style with 1 1/2" x 42" Tines	470	5200	\$ 1,167.00
5515-1246	Pallet Fork - Rail Style with 1 1/2" x 46" Tines	470	5200	\$ 1,167.00
5515-1248	Pallet Fork - Rail Style with 1 1/2" x 48" Tines	470	5200	\$ 1,167.00
5515WT-1242	Pallet Fork - Walk Thru Rail Style with 1 1/2" x 42" Tines	470	5200	\$ 1,167.00
5515WT-1246	Pallet Fork - Walk Thru Rail Style with 1 1/2" x 46" Tines	470	5200	\$ 1,167.00
5515WT-1248	Pallet Fork - Walk Thru Rail Style with 1 1/2" x 48" Tines	470	5200	\$ 1,167.00

5515E-42	Pallet Fork - Economy with 42" Full Tapered Tines	390	2800	\$ 844.00
5515E-46	Pallet Fork - Economy with 46" Full Tapered Tines	400	2800	\$ 875.00
5515EWT-42	Pallet Fork - Walk Thru Economy with 42" Full Tapered Tines	375	2800	\$ 844.00
5515EWT-46	Pallet Fork - Walk Thru Economy with 46" Full Tapered Tines	385	2800	\$ 875.00

5515-00	Single Tine Bale Stabber adapter for Rail Style Pallet Fork	75	2500	\$ 400.00
5515-02	Double Tine Bale Stabber adapter for Rail Style Pallet Fork	100	4400	\$ 533.00

5515C-36	Pallet Fork - Compact with 36" Tubular Tines	265	1800	\$ 768.00
5515C-42	Pallet Fork - Compact with 42" Tubular Tines	270	1800	\$ 768.00

5507	Pallet Fork (Shaft) with Inverted Tine package	610	Fork 5500 Inv 4000	\$ 2,240.00
5508	Pallet Fork (Shaft) with Telescopic Boom -	625	Fork 5500 Boom 4400	\$ 2,440.00
5511	Telescopic Boom	325	Max 7000	\$ 1,117.00
5520-2	FLAT Weld on Plate - 1 pc (unpainted) (1/4" plate)	60	N/A	\$ 190.00
5520-4	Weld on Plate w/ 3" kick out (1/4" plate)	68	N/A	\$ 210.00
5520-4HD	Heavy Duty Weld On Plate (3/8" plate)	85	N/A	\$ 320.00
5520-3	Plate with Class II Receiver Hitch	105	N/A	\$ 354.00

SKID STEER BUCKETS

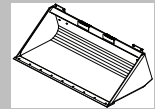

OPTIONAL 5/8" X 6" DOUBLE BEVEL REVERSIBLE BOLT ON CUTTING EDGE

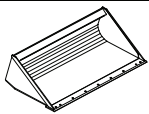

HIGH VOLUME BUCKETS

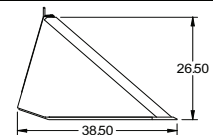

GRAPPLE SOLD SEPARATELY

Part #	Description	Weight*	Heaped Cap.(Cubic Foot)	List Price
5518-78	78" High Volume Bucket	671	35	\$ 1,755.00
5518-84	84" High Volume Bucket	702	37	\$ 1,846.00
5518-90	90" High Volume Bucket	733	39	\$ 1,926.00
5518-96	96" High Volume Bucket	764	41	\$ 2,017.00
5518-4	4 - Tine Grapple	441	N/A	\$ 1,933.00
GFT-58	Bolt On Grapple Fork Tine with Hardware	20	N/A	\$ 150.00

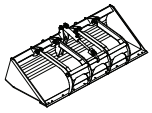

REPLACEMENT BUCKETS

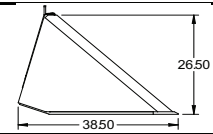

4-TINE FIXED GRAPPLE SOLD SEPARATELY

Part #	Description	Weight*	Heaped Cap.(Cubic Foot)	List Price
5521-54	54" Replacement Bucket	440	16	\$ 931.00
5521-60	60" Replacement Bucket	466	19	\$ 1,038.00
5521-66	66" Replacement Bucket	492	22	\$ 1,157.00
5521-72	72" Replacement Bucket	518	24	\$ 1,238.00
5521-78	78" Replacement Bucket	560	26	\$ 1,286.00
5521-84	84" Replacement Bucket	587	28	\$ 1,360.00
5521-90	90" Replacement Bucket	615	30	\$ 1,448.00
5521-96	96" Replacement Bucket	643	32	\$ 1,563.00
GF24-4	4-Tine Fixed Single Cylinder Grapple	192		\$ 848.00

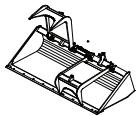

REPLACEMENT BUCKET with SCRAP GRAPPLE

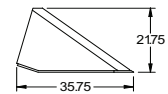

5521-66GF	66" Replacement Bucket with Scrap Grapple	842	22	\$ 3,480.00
5521-72GF	72" Replacement Bucket with Scrap Grapple	868	24	\$ 3,703.00
5521-78GF	78" Replacement Bucket with Scrap Grapple	910	26	\$ 3,874.00
5521-84GF	84" Replacement Bucket with Scrap Grapple	937	28	\$ 4,098.00

OPTIONAL 5/8" X 6" DOUBLE BEVEL REVERSIBLE BOLT ON CUTTING EDGE

DBF-586-54	54" 5/8" X 6" Double Bevel Reversible Bolt on Cutting Edge	60	N/A	\$ 185.00
DBF-586-60	60" 5/8" X 6" Double Bevel Reversible Bolt on Cutting Edge	65	N/A	\$ 185.00
DBF-586-66	66" 5/8" X 6" Double Bevel Reversible Bolt on Cutting Edge	71	N/A	\$ 185.00
DBF-586-72	72" 5/8" X 6" Double Bevel Reversible Bolt on Cutting Edge	76	N/A	\$ 200.00
DBF-586-78	78" 5/8" X 6" Double Bevel Reversible Bolt on Cutting Edge	76	N/A	\$ 200.00
DBF-586-84	84" 5/8" X 6" Double Bevel Reversible Bolt on Cutting Edge	89	N/A	\$ 200.00
DBF-586-90	90" 5/8" X 6" Double Bevel Reversible Bolt on Cutting Edge	91	N/A	\$ 225.00
DBF-586-96	96" 5/8" X 6" Double Bevel Reversible Bolt on Cutting Edge	97	N/A	\$ 225.00

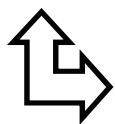

Rock Bucket pricing page 1

Roto-King & 8 ft Sq. Bale Stabbers pricing page 2

Double round bale stabber & Sur-Grip Bale Grabber pricing page 3

Manure Buckets & Dozer Blade pricing page 11



Skid Steer for 1994 & Older (Dog Ear) Hook- Up

New Holland L553-L554-L555-L775-L779-L781-L783-L784-L785-L865

43" Wide Hook-up

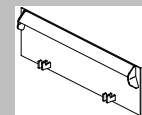

Part #	Description	Weight*	Lift Cap.	List Price
7100	Single Tine Bale Stabber with Stabilizer Tines	140	2500	\$ 745.00
7102	Double Tine Bale Stabber	145	4400	\$ 940.00
7115-1442	Pallet Fork - Rail Style with 1 1/4" x 42" Tines	400	4000	\$ 1,141.00
7115-1446	Pallet Fork - Rail Style with 1 1/4" x 46" Tines	400	4000	\$ 1,141.00
7115-1448	Pallet Fork - Rail Style with 1 1/4" x 48" Tines	400	4000	\$ 1,141.00
7115WT-1442	Pallet Fork - Walk Thru Rail Style with 1 1/4" x 42" Tines	400	4000	\$ 1,141.00
7115WT-1446	Pallet Fork - Walk Thru Rail Style with 1 1/4" x 46" Tines	400	4000	\$ 1,141.00
7115WT-1448	Pallet Fork - Walk Thru Rail Style with 1 1/4" x 48" Tines	400	4000	\$ 1,141.00

7115-1242	Pallet Fork - Rail Style with 1 1/2" x 42" Tines	470	5200	\$ 1,313.00
7115-1246	Pallet Fork - Rail Style with 1 1/2" x 46" Tines	470	5200	\$ 1,313.00
7115-1248	Pallet Fork - Rail Style with 1 1/2" x 48" Tines	470	5200	\$ 1,313.00
7115WT-1242	Pallet Fork - Walk Thru Rail Style with 1 1/2" x 42" Tines	470	5200	\$ 1,313.00
7115WT-1246	Pallet Fork - Walk Thru Rail Style with 1 1/2" x 46" Tines	470	5200	\$ 1,313.00
7115WT-1248	Pallet Fork - Walk Thru Rail Style with 1 1/2" x 48" Tines	470	5200	\$ 1,313.00
5515-00	Single Tine Bale Stabber adapter for Rail Style Pallet Fork	75	2500	\$ 400.00
5515-02	Double Tine Bale Stabber adapter for Rail Style Pallet Fork	100	4400	\$ 533.00
7119	UNI-TACH Skid Steer Attachment Carrier	165	4000	\$ 1,296.00

Rock Bucket pricing page 3
Roto-King & 8 ft Sq. Bale Stabbers pricing page 4
Double Round Bale Stabbers & Sur-Grip Bale Grabber pricing page 5
Replacement Buckets & High Volume Bucket pricing page 46
Manure Buckets & Dozer Blade pricing page 13



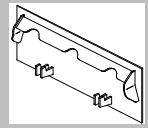

Skid Steer for 1994 & Older (Dog Ear) Hook- Up

New Holland L35-L424-L425-L445-L451-L452-L454-L455
30 3/4" Wide Hook-up

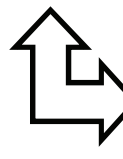
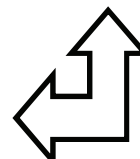

Part #	Description	Weight*	Lift Cap.	List Price
7200	Single Tine Bale Stabber with Stabilizer Tines	140	2500	\$ 745.00
7202	Double Tine Bale Stabber	145	4400	\$ 940.00
7215-1442	Pallet Fork - Rail Style with 1 1/4" x 42" Tines	400	4000	\$ 1,141.00
7215-1446	Pallet Fork - Rail Style with 1 1/4" x 46" Tines	400	4000	\$ 1,141.00
7215-1448	Pallet Fork - Rail Style with 1 1/4" x 48" Tines	400	4000	\$ 1,141.00
7215WT-1442	Pallet Fork - Walk Thru Rail Style with 1 1/4" x 42" Tines	400	4000	\$ 1,141.00
7215WT-1446	Pallet Fork - Walk Thru Rail Style with 1 1/4" x 46" Tines	400	4000	\$ 1,141.00
7215WT-1448	Pallet Fork - Walk Thru Rail Style with 1 1/4" x 48" Tines	400	4000	\$ 1,141.00
7215-1242	Pallet Fork - Rail Style with 1 1/2" x 42" Tines	470	5200	\$ 1,313.00
7215-1246	Pallet Fork - Rail Style with 1 1/2" x 46" Tines	470	5200	\$ 1,313.00
7215-1248	Pallet Fork - Rail Style with 1 1/2" x 48" Tines	470	5200	\$ 1,313.00
7215WT-1242	Pallet Fork - Walk Thru Rail Style with 1 1/2" x 42" Tines	470	5200	\$ 1,313.00
7215WT-1246	Pallet Fork - Walk Thru Rail Style with 1 1/2" x 46" Tines	470	5200	\$ 1,313.00
7215WT-1248	Pallet Fork - Walk Thru Rail Style with 1 1/2" x 48" Tines	470	5200	\$ 1,313.00
5515-00	Single Tine Bale Stabber adapter for Rail Style Pallet Fork	75	2500	\$ 400.00
5515-02	Double Tine Bale Stabber adapter for Rail Style Pallet Fork	100	4400	\$ 533.00
7219	UNI-TACH Skid Steer Attachment Carrier	165	4000	\$ 1,296.00

Rock Bucket pricing page 3
Roto-King & 8 ft Sq. Bale Stabbers pricing page 4
Double Round Bale Stabbers & Sur-Grip Bale Grabber pricing page 5
Replacement Buckets & High Volume Bucket pricing page 46
Manure Buckets & Dozer Blade pricing page 13

Skid Steer for Gehl 3725 & 3825 Quik Tach Series

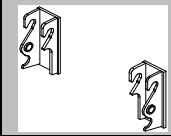

Part #	Description	Weight*	Lift Cap.	List Price
8300	Single Tine Bale Stabber with Stabilizer Tines	195	2500	\$ 745.00
8302	Double Tine Bale Stabber	210	4400	\$ 940.00
8315-1442	Pallet Fork - Rail Style with 1 1/4" x 42" Tines	400	4000	\$ 1,236.00
8315-1446	Pallet Fork - Rail Style with 1 1/4" x 46" Tines	400	4000	\$ 1,236.00
8315-1448	Pallet Fork - Rail Style with 1 1/4" x 48" Tines	400	4000	\$ 1,236.00
5515-00	Single Tine Bale Stabber adapter for Rail Style Pallet Fork	75	2500	\$ 400.00
5515-02	Double Tine Bale Stabber adapter for Rail Style Pallet Fork	100	4400	\$ 533.00
8319	UNI-TACH Skid Steer Attachment Carrier	169	4000	\$ 1,204.00

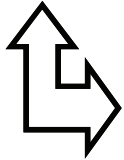

Rock Bucket pricing page 3
Roto-King & 8 ft Sq. Bale Stabbers pricing page 4
Double Round Bale Stabbers & Sur-Grip Bale Grabber pricing page 5
Replacement Buckets & High Volume Bucket pricing page 46
Manure Buckets & Dozer Blade pricing page 13

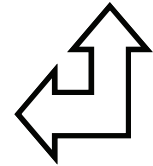

Skid Steer for Gehl 4625, 5625 & 6625 Series Loaders

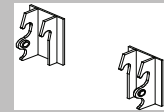

Part #	Description	Weight*	Lift Cap.	List Price
8400	Single Tine Bale Stabber with Stabilizer Tines	195	2500	\$ 745.00
8402	Double Tine Bale Stabber	210	4400	\$ 940.00
8415-1442	Pallet Fork - Rail Style with 1 1/4" x 42" Tines	400	4000	\$ 1,236.00
8415-1446	Pallet Fork - Rail Style with 1 1/4" x 46" Tines	400	4000	\$ 1,236.00
8415-1448	Pallet Fork - Rail Style with 1 1/4" x 48" Tines	400	4000	\$ 1,236.00
5515-00	Single Tine Bale Stabber adapter for Rail Style Pallet Fork	75	2500	\$ 400.00
5515-02	Double Tine Bale Stabber adapter for Rail Style Pallet Fork	100	4400	\$ 533.00
8419	UNI-TACH Skid Steer Attachment Carrier	169	4000	\$ 1,204.00

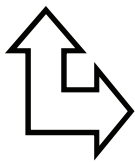

Rock Bucket pricing page 3
Roto-King & 8 ft Sq. Bale Stabbers pricing page 4
Double Round Bale Stabbers & Sur-Grip Bale Grabber pricing page 5
Replacement Buckets & High Volume Bucket pricing page 46
Manure Buckets & Dozer Blade pricing page 13

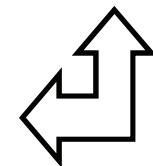

Skid Steer for Gehl E-Series Universal Skid Steer Style Hook Up See page 45

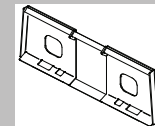

Sur-Lock Quik-Tach Systems

Part #	Description	Weight*	Lift Cap.	List Price
21460	Sur-Lock Quik-Tach System for JD 145 & 146 Loader Models with 10" centers (1" top pin - 1 1/8" bottom pin)	123	N/A	\$ 768.00
22158	Sur-Lock Quik-Tach System for JD 145, 146, 148, & 158 Loader Models with 13" centers (all pins - 1 1/8")	123	N/A	\$ 768.00
22168	Sur-Lock Quik-Tach System for JD 168 Loader Models	135	N/A	\$ 790.00

22175	Sur-Lock Quik-Tach System for JD 175 Loaders (pin sizes needed)	125	N/A	\$ 896.00
22500	Custom Built Sur-Lock Quik-Tach System (Quik-Tach System can be manufactured for most loaders equipped with twin cylinders directly in-line with the main loader frame. ALL custom built Quik-Tach Systems require a schematic drawing)		N/A	\$ 896.00
36700	Sur-Lock Quik-Tach System for JD 620, 625, 720, & 725 Loaders w/o Factory Quick Attach (1 3/8" x 13" Center Units ONLY)	148	N/A	\$ 829.00
36750	Sur-Lock Quik-Tach System for KD Loaders with 1 3/8" x 13" Center Units ONLY	148	N/A	\$ 829.00

Westendorf 20 Series Loaders

(Includes all WL & TA Models with 39 1/2" On Center)

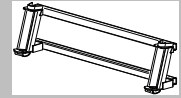

Part #	Description	Weight*	Lift Cap.	List Price
4300	Single Tine Bale Stabber with Stabilizer Tines	115	2500	\$ 660.00
4302	Double Tine Bale Stabber - 1 bale capacity	130	4400	\$ 834.00
4305	Pallet Fork - Shaft Style w/roll guard (1 5/8" shaft)	495	5500	\$ 1,700.00
4315-1248	Pallet Fork - Rail Style with 1 1/2" x 48" Tines	420	5200	\$ 1,395.00
5515-00	Single Tine Bale Stabber adapter for Rail Style Pallet Fork	75	2500	\$ 400.00
5515-02	Double Tine Bale Stabber adapter for Rail Style Pallet Fork	100	4400	\$ 533.00
4307	Pallet Fork (Shaft) with Inverted Tine package	610	Fork 5500 Inv 4000	\$ 2,240.00
4308	Pallet Fork (Shaft) with Telescopic Boom -	625	Fork 5500 Boom 4400	\$ 2,440.00
4311	Telescopic Boom	325	Max 7000	\$ 1,134.00
4319	UNI-TACH Skid Steer Attachment Carrier	155	4000	\$ 944.00
4420-1	Westendorf Weld-On Brackets	40	N/A	\$ 140.00

Rock Bucket pricing page 3

Roto-King & 8 ft Sq. Bale Stabbers pricing page 4

Double Round Bale Stabbers & Sur-Grip Bale Grabber pricing page 5

Replacement Buckets pricing page 11 & High Volume Bucket pricing page 12

Manure Buckets & Dozer Blade pricing page 13

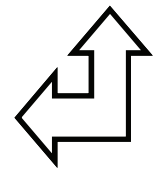
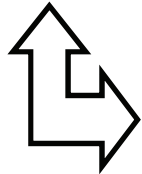

Westendorf 40 Series Loaders

(Includes All WL, TA, & XTA 400 Models & CC Series with 45 1/2" On Center)

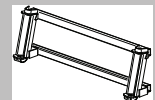

Part #	Description	Weight*	Lift Cap.	List Price
4400	Single Tine Bale Stabber with Stabilizer Tines	115	2500	\$ 660.00
4402	Double Tine Bale Stabber - 1 bale capacity	130	4400	\$ 834.00
4405	Pallet Fork - Shaft Style w/roll guard (1 5/8" shaft)	495	5500	\$ 1,700.00
4415-1248	Pallet Fork - Rail Style with 1 1/2" x 48" Tines	420	5200	\$ 1,395.00
5515-00	Single Tine Bale Stabber adapter for Rail Style Pallet Fork	75	2500	\$ 400.00
5515-02	Double Tine Bale Stabber adapter for Rail Style Pallet Fork	100	4400	\$ 533.00
4407	Pallet Fork (Shaft) with Inverted Tine package	615	Fork 5500 Inv 4000	\$ 2,240.00
4408	Pallet Fork (Shaft) with Telescopic Boom -	630	Fork 5500 Boom 4400	\$ 2,440.00
4411	Telescopic Boom	325	Max 7000	\$ 1,134.00
4419	UNI-TACH Skid Steer Attachment Carrier	165	4000	\$ 956.00
4420-1	Westendorf Weld-On Brackets	40	N/A	\$ 140.00

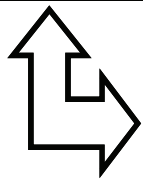

Rock Bucket pricing page 3
Roto-King & 8 ft Sq. Bale Stabbers pricing page 4
Double Round Bale Stabbers & Sur-Grip Bale Grabber pricing page 5
Replacement Buckets pricing page 11 & High Volume Bucket pricing page 12
Manure Buckets & Dozer Blade pricing page 13

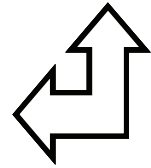

Westendorf 70 Series Loaders

(XTA 700 with 54" On Center)

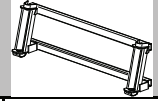

Part #	Description	Weight*	Lift Cap.	List Price
4500	Single Tine Bale Stabber with Stabilizer Tines	115	2500	\$ 676.00
4502	Double Tine Bale Stabber - 1 bale capacity	130	4400	\$ 854.00
4505	Pallet Fork - Shaft Style w/roll guard (1 5/8" shaft)	495	5500	\$ 1,739.00
4515-1248	Pallet Fork - Rail Style with 1 1/2" x 48" Tines	420	5200	\$ 1,427.00
5515-00	Single Tine Bale Stabber adapter for Rail Style Pallet Fork	75	2500	\$ 400.00
5515-02	Double Tine Bale Stabber adapter for Rail Style Pallet Fork	100	4400	\$ 533.00
4507	Pallet Fork (Shaft) with Inverted Tine package	615	Fork 5500 Inv 4000	\$ 2,290.00
4508	Pallet Fork (Shaft) with Telescopic Boom -	630	Fork 5500 Boom 4400	\$ 2,495.00
4511	Telescopic Boom	325	Max 7000	\$ 1,160.00
4420-1	Westendorf Weld-On Brackets	40	N/A	\$ 140.00

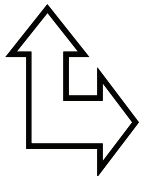

Rock Bucket pricing page 3
Roto-King & 8 ft Sq. Bale Stabbers pricing page 4
Double Round Bale Stabbers & Sur-Grip Bale Grabber pricing page 5
Replacement Buckets pricing page 11 & High Volume Bucket pricing page 12
Manure Buckets & Dozer Blade pricing page 13

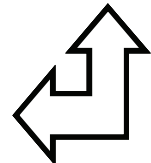

Zetor Loaders

90, 92, 92HL, 100, 101, 101SL, 102, 102HL, 102SLX, 112SLX, 202, 202SL,
SEE "EURO" HOOK UP PAGE 28

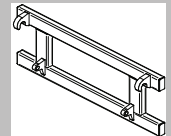

Custom Built Product Call For Price Quote

Part #	Description	Weight*	Lift Cap.	List Price
10000	Single Tine Bale Stabber with Stabilizer Tines	150	2500	
10002	Double Tine Bale Stabber - 1 bale capacity	175	4400	
10005	Pallet Fork - Shaft Style w/roll guard (1 5/8" shaft)	495	5500	
10015-1248	Pallet Fork - Rail Style with 1 1/2" x 48" Tines	420	5200	
10008	Pallet Fork (Shaft) with Telescopic Boom -	630	Fork 5500 Boom 4400	
10009	Pallet Fork (Shaft) with Bale Stabber & Inverted Tine package	725	Fork 5500 Stbr 4400 Inv 4000	
10011	Telescopic Boom	325	Max 7000	
10019	UNI-TACH Skid Steer Attachment Carrier	140	4000	

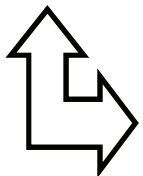

Rock Bucket pricing page 3
Roto-King & 8 ft Sq. Bale Stabbers pricing page 4
Double Round Bale Stabbers & Sur-Grip Bale Grabber pricing page 5
Replacement Buckets pricing page 11 & High Volume Bucket pricing page 12
Manure Buckets & Dozer Blade pricing page 13

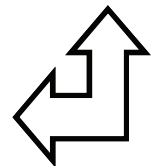

This page intentionally left blank

TELEHANDLER ATTACHMENTS

Rock Bucket pricing page 3

Roto-King & 8 ft Sq. Bale Stabbers pricing page 4

Double Round Bale Stabbers & Sur-Grip Bale Grabber pricing page 5

Replacement Buckets pricing page 11 & High Volume Bucket pricing page 12

Manure Buckets & Dozer Blade pricing page 13

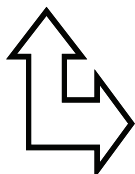

BOBCAT VERSAHANDLER 518 & 723

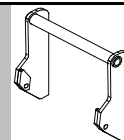

PART #	DESCRIPTION	WT	Lift Cap.	LIST PRICE
11702	DOUBLE TINE BALE STABBER	175	4400	\$ 1,743.00
11705	Pallet Fork - Shaft Style w/roll guard (1 5/8" shaft)	600	5500	\$ 2,995.00

GEHL DYNATTACH - RS6 TELEHANDLER

(NARROW - 11.5" inside measurement)

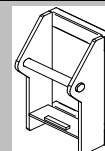

PART #	DESCRIPTION	WT	Lift Cap.	LIST PRICE
12802	DOUBLE TINE BALE STABBER	175	4400	\$ 1,395.00
12805	Pallet Fork - Shaft Style w/roll guard (1 5/8" shaft)	600	5500	\$ 2,435.00

GEHL DYNATTACH - RS5 TELEHANDLER

(WIDE - 13" inside measurement)

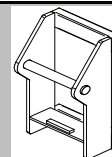

PART #	DESCRIPTION	WT	Lift Cap.	LIST PRICE
12902	DOUBLE TINE BALE STABBER	175	4400	\$ 1,430.00
12905	Pallet Fork - Shaft Style w/roll guard (1 5/8" shaft)	600	5500	\$ 2,470.00

JOHN DEERE 3200/3400/3800 TELEHANDLER

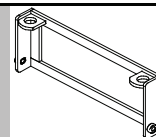

PART #	DESCRIPTION	WT	Lift Cap.	LIST PRICE
9402	DOUBLE TINE BALE STABBER	175	4400	\$ 1,593.00
9405	Pallet Fork - Shaft Style w/roll guard (1 5/8" shaft)	600	5500	\$ 2,795.00

JCB 520, 524, & 527 Series Telehandlers

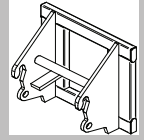

PART #	DESCRIPTION	WT	Lift Cap.	LIST PRICE
9502	DOUBLE TINE BALE STABBER	175	4400	\$ 1,525.00
9505	Pallet Fork - Shaft Style w/roll guard (1 5/8" shaft)	600	5500	\$ 2,715.00

New Holland LM 430 (Yellow) JCB 530 & 540

WITH Q-FIT HOOK-UP

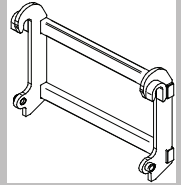

PART #	DESCRIPTION	WT	Lift Cap.	LIST PRICE
7402	DOUBLE TINE BALE STABBER	175	4400	\$ 1,668.00
7405	Pallet Fork - Shaft Style w/roll guard (1 5/8" shaft)	600	5500	\$ 2,915.00

MANITOU

New Holland LM 435 (Blue), LM 5040, LM 5050 LM5060
Gehl CT 516, CT 618, CT 723

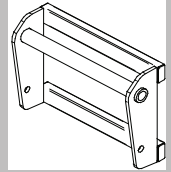

PART #	DESCRIPTION	WT	Lift Cap.	LIST PRICE
11502	DOUBLE TINE BALE STABBER	175	4400	\$ 1,668.00
11505	Pallet Fork - Shaft Style w/roll guard (1 5/8" shaft)	600	5500	\$ 2,915.00

Rock Bucket pricing page 3

Roto-King & 8 ft Sq. Bale Stabbers pricing page 4

Double Round Bale Stabbers & Sur-Grip Bale Grabber pricing page 5

Replacement Buckets pricing page 11 & High Volume Bucket pricing page 12

Manure Buckets & Dozer Blade pricing page 13

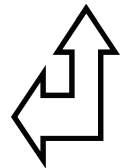
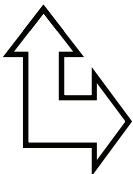

WHEEL LOADER ATTACHMENTS

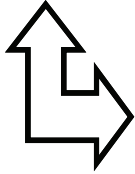

Rock Bucket pricing page 3
 Roto-King & 8 ft Sq. Bale Stabbers pricing page 4
 Double Round Bale Stabbers & Sur-Grip Bale Grabber pricing page 5

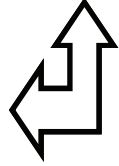

CAT IT 14-24-28 & CAT 924 & 930G

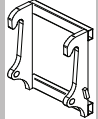

PART #	DESCRIPTION	WT	Lift Cap.	LIST PRICE
12402	DOUBLE TINE BALE STABBER	175	4400	\$ 1,775.00
12405	Pallet Fork - SHAFT STYLE w/ Class III ITA Tines	1425	10,000	\$ 5,265.00
12415	Pallet Fork - RAIL STYLE w/ Class III ITA Tines	1575	10,000	\$ 5,665.00

JOHN DEERE 244J, JCB 409B, KOMATSU WA95, VOLVO L35

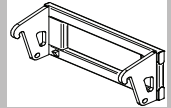

PART #	DESCRIPTION	WT	Lift Cap.	LIST PRICE
12102	DOUBLE TINE BALE STABBER	175	4400	\$ 1,070.00
12105	Pallet Fork - Shaft Style w/roll guard (1 5/8" shaft)	1425	5500	\$ 1,995.00
12115-1248	Pallet Fork - RAIL STYLE w/ Class II ITA Tines	1575	5200	\$ 1,617.00

JRB 500 SERIES QT (includes JD 444/544, Case 521/621, Komatsu WA 200/320, NH LW 170)

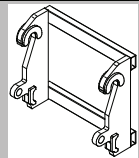

PART #	DESCRIPTION	WT	Lift Cap.	LIST PRICE
12202	DOUBLE TINE BALE STABBER	175	4400	\$ 2,075.00
12205	Pallet Fork - SHAFT STYLE w/ Class III ITA Tines	1425	10,000	\$ 5,265.00
12215	Pallet Fork - RAIL STYLE w/ Class III ITA Tines	1575	10,000	\$ 5,665.00

VOLVO L-SERIES (includes L50-60-70-80-90-110-120)

JCB 416 & 426

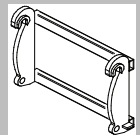

PART #	DESCRIPTION	WT	Lift Cap.	LIST PRICE
12302	DOUBLE TINE BALE STABBER	175	4400	\$ 1,775.00
12305	Pallet Fork - SHAFT STYLE w/ Class III ITA Tines	1425	10,000	\$ 5,265.00
12315	Pallet Fork - RAIL STYLE w/ Class III ITA Tines	1575	10,000	\$ 5,665.00

TELEHANDLER HOOKUPS

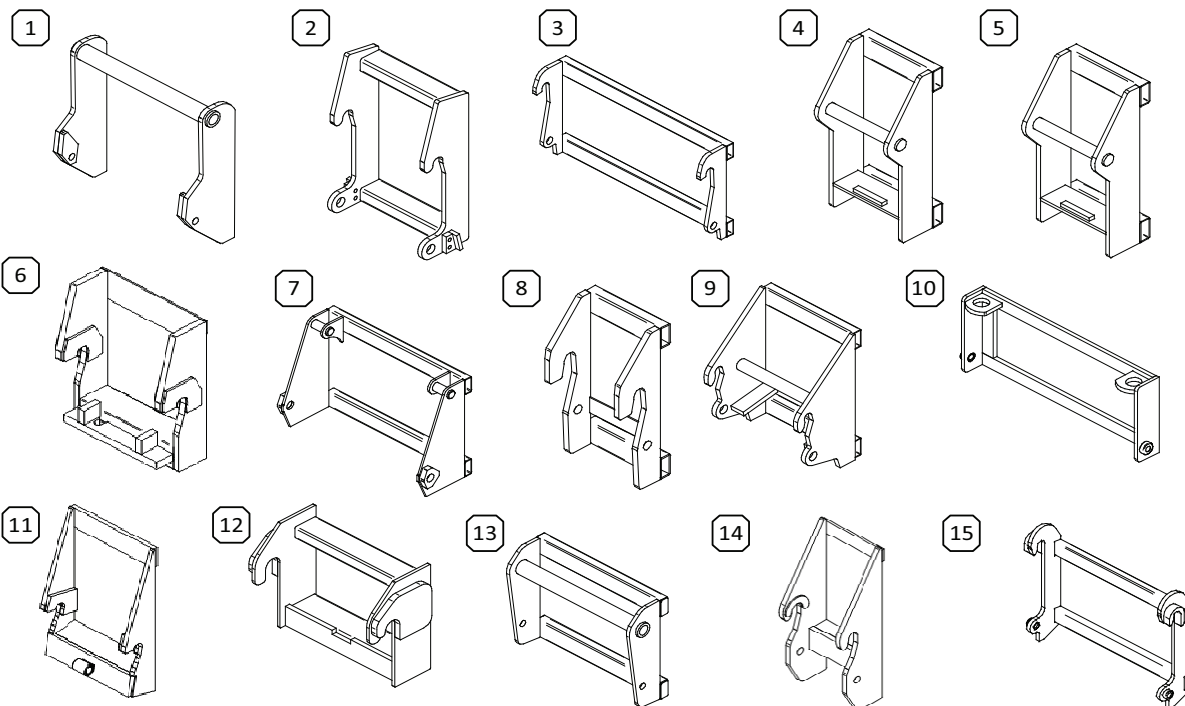

- | | |
|--|--|
| 1. Bobcat Versahandler 518 & 723 | 9. JCB 520, 524, & 527 |
| 2. Cat TH62-63-82-83 | 10. John Deere 3200, 3400, & 3800 Telehandler |
| 3. Gehl AL700 | 11. JLG |
| 4. Gehl Dynattach (Narrow – 11.5”) RS6 | 12. Lull |
| 5. Gehl Dynattach (Wide – 13”) RS5 | 13. Manitou, New Holland LM435 (Blue) & LM5060, and Gehl CT618 & CT723 |
| 6. Gradall 534D | 14. NH M428, M427, M459 |
| 7. Ingersoll Rand | 15. Q-Fit: New Holland LM430 (Yellow) and JCB 530 & 540 |
| 8. JCB 506C | |

WHEEL LOADER HOOKUPS

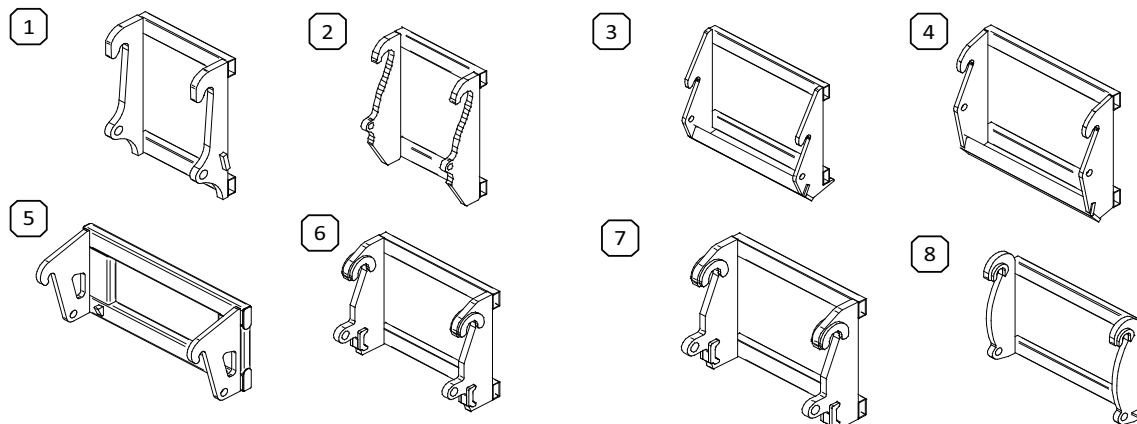

- | | |
|---------------------------------------|--|
| 1. Cat IT 14-24-28 and Cat 924 & 930G | 5. John Deere 244J |
| 2. CWS (Canadian coupler) | 6. JRB 500 Series |
| 3. Gehl AWS 36 Series | 7. JRB 600 Series |
| 4. Gehl AWS 46 Series | 8. Volvo L Series: L50-60-70-80-90-110-120 |

BULK OIL STORAGE TANKS & STANDS

TANKS

TANK SIZE	WEIGHT	LIST
85 Gallon	99	\$ 290.00
85 Gallon w/extra FILL port	102	\$ 306.00
114 Gallon	165	\$ 348.00
114 Gallon w/extra FILL port	168	\$ 364.00

TANKS COME STANDARD WITH 1" BRASS VALVES - 2" LOCKABLE FILL PORT - DRIP TRAY - SIGHT GAUGE WITH BRASS FITTINGS & CLEAR HOSE

TANKS AVAILABLE IN 5 COLORS FOR CODING CONVENIENCE
(BLACK - YELLOW - GREEN - RED - BLUE)

STANDS

	WEIGHT	LIST
2 TANK STAND	110	\$ 310.00
3 TANK STAND	156	\$ 423.00

TANKS STANDS - BLACK ONLY

MINIMUM TANK ORDER - 4 UNITS

STANDARD DISCOUNTING ONLY