

PRICE LIST

August 2023

Table of Contents

PRICE LIST	PRODUCT	PAGE
PUMPS	Roller Pumps	A-4
	GEMINI Dual Pump Kit	A-6
	FMC-75-HYD and FMC-75SP-HYD Series	A-6
	FMC-HYD Series	A-7
	FMC-150-HYD Series	A-8
	FMC-200-HYD Series	A-9
	FMCS-125-HYD and FMCWS-125-HYD Series	A-10
	FMCS-155F-HYD and FMCWS-155F/S-HYD Series	A-10
	FMCS-255F-HYD and FMCWS-255F-HYD Series	A-10
	FMCS-155FS-HYD Series	A-11
	FMCS-205F-HYD Series	A-11
	FMC-650-HYD Series	A-12
	Oasis™ WetSeal Accessories	A-12
	FMCWS-650-HYD Series	A-13
	FMC-750F-HYD and FMC-755FS-HYD Series	A-13
	FMC-855F-HYD Series	A-13
	PTOC Series	A-14
	PTOC-150 Series	A-15
	GE Series	A-16
	FMC Series	A-18
	FMC-CW Series	A-18
	FMC-MAG-D Series	A-20
	FMC-CW-MAG-D Series	A-20
	Electric Motor Driven - MPH, MPA, MFP	A-22
	Ball Valves	A-24
	PUMP PARTS	BAC-75-HYD-200 Motors
BAC-75-HYD-300 Motors		B-26
BAC-75-HYD-M Motors		B-27
FMC-75-HYD and FMC-75SP-HYD		B-27
FMC-HYD		B-28
FMC-150-HYD		B-29
FMC-200-HYD		B-30
FMCS-125-HYD and FMCWS-125-HYD		B-31
FMCS-155F-HYD and FMCWS-155F-HYD		B-31
FMCS-155FS-HYD		B-32
FMCS-205F-HYD		B-33
DPK - Gemini Dual Pump Kit		B-33
FMC-650-HYD and FMCWS-650F-HYD		B-34
OASIS-RES		B-34
FMC-750F-HYD and FMC-755FS-HYD		B-35
FMC-855F-HYD		B-35
BGKB - Belt Guard Kit for PTOC and PTOC-150		B-36
PTOC		B-36
PTOC-150		B-37
GE-100-A		B-38
GE-75		B-38
GE-85 and GE-85SP		B-38
GE-1600		B-39
GE-650		B-39
GE-660		B-39
GE-800		B-39
GE-860		B-39
FMC & FMC-200		B-40
FMC-150		B-40
FMC-650 & FMC-650F & FMCWS-650		B-41
MAG-D Clutches		B-41
FMC-CW, FMC-CW-150, & FMC-CW-200		B-42
FMC-CW-75 and FMC-CW-75SP		B-42
FMC-CW-650 and FMCWS-CW-650		B-43
FMC-CW-800		B-43
RP-600		B-44
RP-800		B-44
BAC-10-RP ROLLER PUMP ADAPTERS		B-44
RP-TBK		B-44

Terms and Conditions

How to Order:

E-mail sales@acepumps.com
Fax 901-774-6147
Phone 800-843-2293 or 901-948-8514

Order Terms:

All prices are in US Dollars.
Prices are subject to change without notice.

Minimum Order \$50.00 net
Drop Ship Charge \$30.00 per order

Freight Terms North America EXW (1650 Channel Ave. – Memphis, TN 38113) (Incoterms 2020)
 International FCA (1650 Channel Ave. – Memphis, TN 38113) (Incoterms 2020)

Finance Charge A 1.5% per month finance charge will be added to invoices if not paid within invoice terms.



ROLLER PUMPS



RP-600C



**RK-RP-600
Universal 6 Roller
Repair Kit**

6 Roller Pumps

MODEL	EDP	DESCRIPTION	LBS	PRICE
RP-600C	15050	Cast iron six roller pump with 5/8" shaft. Counterclockwise rotation from shaft end. Max. flow: 21.8 GPM Max. pressure: 300 PSI	9	\$285.00
RP-600C-R	15051	Same as above with clockwise rotation for direct coupling to gas engine.	9	\$295.00
RP-600C-60	15055	Bulk package containing 60) RP-600C pumps. 30 pumps per layer x 2 layers.	528	\$16,815.00
RK-RP-600	14975	Repair kit - Universal 6 roller repair kit includes seals, O-rings, and rollers.	1	\$62.50

See pages B-44 for parts.



**RP-TBK
Torque Bar Kit**





RP-800C



**RK-RP-800
Universal 6 Roller
Repair Kit**

8 Roller Pumps

MODEL	EDP	DESCRIPTION	LBS	PRICE
RP-800C	15000	Cast iron eight roller pump with 15/16" shaft. Counterclockwise rotation from shaft end. Max. flow: 22.5 GPM Max. pressure: 300 PSI	14	\$373.00
RP-800C-R	15001	Same as above with clockwise rotation for direct coupling to gas engine.	14	\$383.00
RP-800C-40	15005	Bulk package containing 40) RP-800C pumps. 20 pumps per layer x 2 layers.	578	\$14,602.00
RK-RP-800	14950	Repair kit - Universal 8 roller repair kit includes seals, O-rings, and rollers.	1	\$87.00

See pages B-44 for parts.



BAC-10-RP6-QC



BAC-10-RP8-QC



RP-BP6

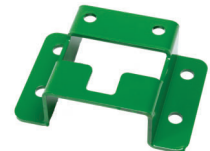

RP-BP8

Accessories

MODEL	EDP	DESCRIPTION	LBS	PRICE
BAC-10-RP6-QC	14880	Multispeed die cast PTO quick coupler for 6 roller pumps with 5/8" shaft.	2	\$67.25
BAC-10-RP8-QC	14830	Multispeed die cast PTO quick coupler for 8 roller pumps with 15/16" shaft.	2	\$71.75
RP-TBK	15100	Torque bar kit for 6 and 8 roller pumps.	2	\$80.50
RP-BP6	15205	Base plate for gas engine mounting of RP-600C-R models	1	\$49.75
RP-BP8	15200	Base plate for gas engine mounting of RP-800C-R models	1	\$55.00

See pages B-44 for parts.



Gemini™ Dual Pump Kit

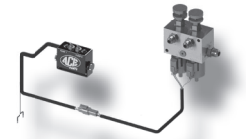

Operates any combination of Ace Pumps equipped with the 204 or 206 motor

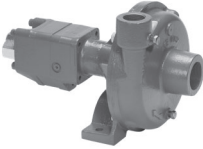
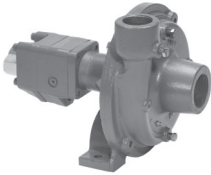
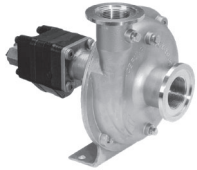
Pump Models	FMC-75-HYD-204 FMC-75-HYD-206	FMC-HYD-204 FMC-HYD-206	FMC-150-HYD-206	FMC-150F-HYD-206 FMC-150FS-HYD-206
Choose any two depending on application requirements!				
Material	Polypropylene	Cast Iron	Cast Iron	Cast Iron or Stainless Steel
Max. Flow	25 gpm	85 gpm	135 gpm	145 gpm
Max. Pressure	100 psi	100 psi	120 psi	120 psi

MODEL	EDP	DESCRIPTION	LBS	PRICE
DPK	74000	Gemini dual pump kit allows two 204 and/or 206 hydraulic motor driven pumps to be controlled from a single remote.	11	\$2,535.50
DPK-EXT	74010	22' Extension cable (optional)		\$121.25

See page B-33 for parts.



1" Suction x 3/4" Discharge FMC-75-HYD-206-PWM FMC-75SP-HYD-204

MODEL	EDP	DESCRIPTION	LBS	PRICE
FMC-75-HYD-204	49775	Poly centrifugal driven by a 4 GPM hydraulic motor with integrated needle valve. Max. flow: 25 GPM Max. pressure: 100 PSI	17	\$1,244.00
FMC-75SP-HYD-204	49691	Poly self-priming centrifugal driven by a 4 GPM hydraulic motor with integrated needle valve. Max. flow: 30 GPM Max. pressure: 60 PSI	19	\$1,297.00
FMC-75-HYD-206	49777	Poly centrifugal driven by a 7 GPM hydraulic motor with integrated needle valve. Max. flow: 27 GPM Max. pressure: 100 PSI	17	\$1,244.00
FMC-75SP-HYD-206	49692	Poly self-priming centrifugal driven by a 7 GPM hydraulic motor with integrated needle valve. Max. flow: 50 GPM Max. pressure: 80 PSI	19	\$1,297.00
FMC-75-HYD-LM	49774	Pump less motor.	11	\$913.00
FMC-75SP-HYD-LM	49695	Self-Priming pump less motor.	13	\$966.00
FMCS		Silicon carbide seal adder.		\$103.00
-PWM		Integrated pulse width modulated hydraulic motor. (206 motor only)		\$1,234.00

See pages B-25 and B-27 for parts.

HYDRAULIC DRIVEN CENTRIFUGAL PUMPS

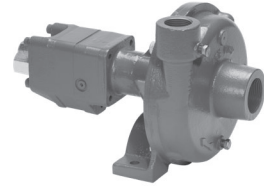

1-1/4" Suction x 1" Discharge

FMC-HYD-204

MODEL	EDP	DESCRIPTION	LBS	PRICE
FMC-HYD-202	49825	Cast iron centrifugal driven by a 2 GPM hydraulic motor with integrated needle valve. Max. flow: 70 GPM Max. pressure: 100 PSI	26	\$1,527.00
FMC-HYD-203	49826	Cast iron centrifugal driven by a 3 GPM hydraulic motor with integrated needle valve. Max. flow: 80 GPM Max. pressure: 100 PSI	26	\$1,527.00
FMC-HYD-204	49800	Cast iron centrifugal driven by a 4 GPM hydraulic motor with integrated needle valve. Max. flow: 85 GPM Max. pressure: 100 PSI	26	\$1,509.00
FMC-HYD-206	49940	Cast iron centrifugal driven by a 7 GPM hydraulic motor with integrated needle valve. Max. flow: 100 GPM Max. pressure: 120 PSI	27	\$1,509.00
FMC-HYD-210	49810	Cast iron centrifugal driven by a 10 GPM hydraulic motor with integrated needle valve. Max. flow: 100 GPM Max. pressure: 120 PSI	27	\$1,509.00
FMC-HYD-310	49850	Cast iron centrifugal driven by a 25 GPM hydraulic motor with integrated needle valve. Max. flow: 100 GPM Max. pressure: 120 PSI	33	\$1,555.00
FMCSH-HYD-206-PWM	50083	Cast iron centrifugal driven by a 7 GPM hydraulic motor with integrated PWM valve. Max. flow: 100 GPM Max. pressure: 120 PSI	33	\$2,846.00
FMC-HYD-LM	49830	Pump less motor for FMC-HYD-2XX models.	18	\$1,173.00
FMC-HYD-310-LM	49855	Pump less motor for FMC-HYD-310 model.	18	\$1,194.00

Options for FMC-HYD Pumps

OPTION	DESCRIPTION	ADD
FMCSH	Silicon carbide shaft seal for abrasives. (For FMC-75-HYD and FMC-HYD pumps)	\$103.00
-CI	Cast iron impeller. (For FMC-HYD pumps)	\$100.00
-SS	Stainless steel fitted package including impeller nut, capscrews, and pipe plugs. (For FMC-HYD pumps)	\$21.00

150 SERIES

HIGH PERFORMANCE

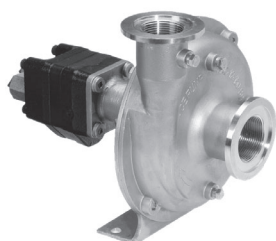

FMC-150FS-HYD-206

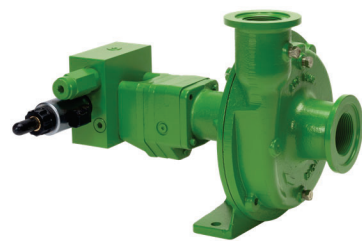

FMCS-150F-HYD-206-PWM

1-1/2" Suction x 1-1/4" Discharge

MODEL	EDP	DESCRIPTION	LBS	PRICE
FMC-150-HYD-206	49920	Cast iron centrifugal driven by a 7 GPM hydraulic motor with integrated needle valve. Max. flow: 135 GPM Max. pressure: 120 PSI	31	\$1,548.00
FMC-150F-HYD-206	49942	Same as above with flanged and NPT ports. Inlet 220 full port flange & 1-1/2" NPT Outlet 200 standard port flange & 1-1/4" NPT Max. flow: 145 GPM Max. pressure: 120 PSI	31	\$1,617.00
FMCS-150F-HYD-206-PWM	50079	Cast iron centrifugal driven by a 7 GPM hydraulic motor with integrated PWM valve. Inlet 220 full port flange & 1-1/2" NPT Outlet 200 standard port flange & 1-1/4" NPT Max. flow: 145 GPM Max. pressure: 120 PSI	38	\$2,954.00
FMC-150FS-HYD-206	49965	316 stainless steel centrifugal driven by a 7 GPM hydraulic motor with integrated needle valve. Inlet 220 full port flange & 1-1/2" NPT Outlet 200 standard port flange & 1-1/4" NPT Max. flow: 145 GPM Max. pressure: 120 PSI	28	\$2,772.00
FMCS-150FS-HYD-206-PWM	50082	316 stainless steel centrifugal driven by a 7 GPM hydraulic motor with integrated PWM valve. Inlet 220 full port flange & 1-1/2" NPT Outlet 200 standard port flange & 1-1/4" NPT Max. flow: 145 GPM Max. pressure: 120 PSI	38	\$4,109.00
FMC-150SP-HYD-206	49956	Cast iron self-priming centrifugal driven by a 7 GPM hydraulic motor with integrated needle valve. Max. flow: 130 GPM Max. pressure: 120 PSI	45	\$2,121.00
FMC-150F-HYD-304	49960	Cast iron centrifugal driven by a 11 GPM hydraulic motor with integrated needle valve. Inlet 220 full port flange & 1-1/2" NPT Outlet 200 standard port flange & 1-1/4" NPT Max. flow: 155 GPM Max. pressure: 130 PSI	31	\$1,849.00
FMCS-150F-HYD-304-PWM	50054	Cast iron centrifugal driven by a 11 GPM hydraulic motor with integrated PWM valve. Inlet 220 full port flange & 1-1/2" NPT Outlet 200 standard port flange & 1-1/4" NPT Max. flow: 155 GPM Max. pressure: 130 PSI	38	\$3,186.00
FMC-150-HYD-LM	49921	Pump less motor for FMC-150-HYD-206 model.	21	\$1,213.00
FMC-150F-HYD-LM	49944	Pump less motor for FMC-150F-HYD-206 model.	22	\$1,282.00
FMC-150FS-HYD-LM	49978	Pump less motor for FMC-150FS-HYD-206 model.	19	\$2,437.00
FMC-150F-HYD-300-LM	50048	Pump less motor for FMC-150F-HYD-304 model.	22	\$1,303.00

See pages B-25, B-26, and B-29 for parts. Options can be found on page A-9.

200 SERIES HIGH FLOW



FMC-200SS-HYD-304

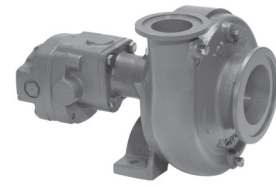

FMC-200F-HYD-304

2" Suction x 1-1/2" Discharge

MODEL	EDP	DESCRIPTION	LBS	PRICE
FMC-200-HYD-210	49840	Cast iron centrifugal driven by a 10 GPM hydraulic motor with integrated needle valve. Max. flow: 180 GPM Max. pressure: 80 PSI	33	\$1,816.00
FMC-200-HYD-304	49859	Cast iron centrifugal driven by a 11 GPM hydraulic motor with integrated needle valve. Max. flow: 200 GPM Max. pressure: 120 PSI	38	\$1,834.00
FMC-200F-HYD-304	49980	Cast iron centrifugal driven by a 13 GPM hydraulic motor with integrated needle valve. Inlet 300 series standard port flange Outlet 220 series full port flange Max. flow: 240 GPM Max. pressure: 120 PSI	38	\$1,993.00
FMC-200SS-HYD-304	50060	316 Stainless steel wet end centrifugal driven by a 11 GPM hydraulic motor with integrated needle valve. Includes stainless impeller. Max. flow: 200 GPM Max. pressure: 120 PSI	36	\$2,495.00
FMC-200-HYD-310	49860	Cast iron centrifugal driven by a 25 GPM hydraulic motor with integrated needle valve. Max. flow: 200 GPM Max. pressure: 120 PSI	38	\$1,944.00
FMC-200-HYD-LM	49842	Pump less motor for FMC-200-HYD-210 model.	23	\$1,298.00
FMC-200-HYD-300-LM	49865	Pump less motor for FMC-200-HYD-3XX models.	23	\$1,319.00
FMC-200F-HYD-300-LM	49989	Pump less motor for FMC-200F-HYD-3XX models.	23	\$1,478.00

See pages B-25, B-26, and B-30 for parts.



-SI Option
Stainless Impeller



-CI Option
Cast Impeller



PWM Motor Option

Options for FMC-150-HYD and FMC-200-HYD Pumps

OPTION	DESCRIPTION	ADD
FMCSC	Silicon carbide shaft seal for abrasives.	\$103.00
150F	Flanged pump ports for 150 series models: Inlet 1-1/2" NPT & 220 full port flange Outlet 1-1/4" NPT & 200 standard port flange.	\$69.00
200F	Flanged pump ports for 200 series models: Inlet 300 standard port flange x Outlet 220 full port flange.	\$159.00
-CI	Cast iron impeller.	\$100.00
-PI	Polypropylene impeller for 150 series models.	\$45.00
-SI	316 Stainless steel impeller. (Standard on 200SS models)	\$270.00
-SS	Stainless steel fitted package including impeller nut, capscrews, and pipe plugs. (Standard on 200SS models)	\$21.00
-PWM	Integrated pulse width modulated hydraulic motor. (206 and 304 motors only)	\$1,234.00

PRO 5 SERIES PUMPS

Improve Reliability Reduce Downtime

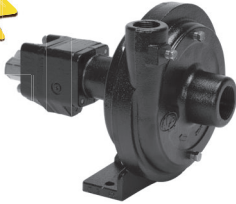





FMCS-125-HYD-204



FMCWS-155FS-HYD-304



FMCWS-255F-HYD-304-PWM

MODEL	EDP	DESCRIPTION	HYD	LBS	PRICE
FMCS-125-HYD-204	50111	E-Coated Cast Iron 1-1/4" NPT Suction 1" NPT Discharge	4 GPM	27	\$1,632.00
FMCS-125-HYD-206	50112	1" NPT Discharge	7 GPM	27	\$1,632.00
FMCS-125-HYD-206-PWM	50113	Max. 92 GPM Max. 120 PSI	7 GPM	34	\$2,866.00
FMCWS-125-HYD-204	50092	 E-Coated Cast Iron	4 GPM	51	\$2,301.00
FMCWS-125-HYD-206	50094	1-1/4" NPT Suction x 1" NPT Discharge	7 GPM	51	\$2,301.00
FMCWS-125-HYD-206-PWM	50093	Max. 92 GPM Max. 120 PSI	7 GPM	57	\$3,535.00
FMCS-155F-HYD-206	50114	E-Coated Cast Iron	7 GPM	31	\$1,714.00
FMCS-155F-HYD-206-PWM	50115	220 Flange & 1-1/2" NPT Suction	7 GPM	38	\$2,968.00
FMCS-155F-HYD-304	50116	200 Flange & 1-1/4" NPT Discharge	11 GPM	36	\$1,924.00
FMCS-155F-HYD-304-PWM	50117	Max. 145 GPM Max. 120 PSI	11 GPM	43	\$3,158.00
FMCWS-155F-HYD-206	50095	 E-Coated Cast Iron	7 GPM	50	\$2,403.00
FMCWS-155F-HYD-206-PWM	50096	220 Flange & 1-1/2" NPT Suction	7 GPM	57	\$3,637.00
FMCWS-155F-HYD-304	50097	200 Flange & 1-1/4" NPT Discharge	11 GPM	56	\$2,588.00
FMCWS-155F-HYD-304-PWM	50098	Max. 145 GPM Max. 120 PSI	11 GPM	62	\$3,822.00
FMCWS-155FS-HYD-206	50140	 316 Stainless Steel	7 GPM		\$3,627.00
FMCWS-155FS-HYD-206-PWM	50141	220 Flange & 1-1/2" NPT Suction	7 GPM		\$4,861.00
FMCWS-155FS-HYD-304	50142	200 Flange & 1-1/4" NPT Discharge	11 GPM		\$3,812.00
FMCWS-155FS-HYD-304-PWM	50143	Max. 145 GPM Max. 120 PSI	11 GPM		\$5,046.00
FMCS-255F-HYD-304	50131	E-Coated Cast Iron	11 GPM	47	\$2,096.00
FMCS-255F-HYD-304-PWM	50132	300 Flange Suction 220 Flange Discharge	11 GPM	54	\$3,330.00
FMCS-255F-HYD-306	50133	Max. 260 GPM Max. 120 PSI	17 GPM	47	\$2,096.00
FMCWS-255F-HYD-304	50130	 E-Coated Cast Iron	11 GPM	61	\$2,785.00
FMCWS-255F-HYD-304-PWM	50129	300 Flange Suction 220 Flange Discharge	11 GPM	68	\$4,019.00
FMCWS-255F-HYD-306	50099	Max. 260 GPM Max. 120 PSI	17 GPM	61	\$2,785.00

See pages B-25, B-26, and B-31 for parts.

155 SERIES

HIGH PERFORMANCE

220 Flange Suction x 200 Flange Discharge FMCSC-155FS-HYD-304-PWM

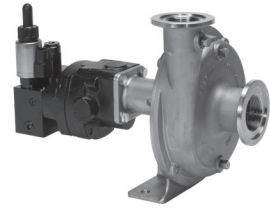

MODEL	EDP	DESCRIPTION	LBS	PRICE
FMCSC-155FS-HYD-206	50056	316 SS centrifugal driven by a 7 GPM hydraulic motor with integrated needle valve. Severe duty silicon carbide seal. Inlet 220 full port flange & 1-1/2" NPT Outlet 200 standard port flange & 1-1/4" NPT Max. flow: 145 GPM Max. pressure: 120 PSI	27	\$2,875.00
FMCSC-155FS-HYD-304	50110	316 SS centrifugal driven by a 11 GPM hydraulic motor. Severe duty silicon carbide seal. Inlet 220 full port flange & 1-1/2" NPT Outlet 200 standard port flange & 1-1/4" NPT Max. flow: 155 GPM Max. pressure: 130 PSI	32	\$3,107.00

See pages B-25, B-26, and B-32 for parts.

205 SERIES

HIGH FLOW

300 Flange Suction x 220 Flange Discharge

FMCSC-205F-HYD-304



MODEL	EDP	DESCRIPTION	LBS	PRICE
FMCSC-205F-HYD-304	50033	Cast iron centrifugal driven by a 13 GPM hydraulic motor with integrated needle valve. Severe duty silicon carbide seal. Inlet 300 series standard port flange Outlet 220 series full port flange Max. flow: 240 GPM Max. pressure: 120 PSI	38	\$2,096.00
FMCSC-205FS-HYD-304	50037	316 Stainless steel centrifugal driven by a 13 GPM hydraulic motor with integrated needle valve. Includes stainless impeller. Inlet 300 series standard port flange. Outlet 220 series full port flange. Max. flow: 240 GPM Max. pressure: 120 PSI	38	\$3,370.00

See pages B-26 and B-33 for parts.

Options for FMCSC-155FS-HYD & FMCSC-205F-HYD Pumps

OPTION	DESCRIPTION	ADD
-CI	Cast iron impeller.	\$100.00
-SI	316 Stainless steel impeller for 205 series models. (Standard on 205FS models)	\$270.00
-SS	Stainless steel fitted package including impeller nut, capscrews, and pipe plugs. (Standard on 205FS models)	\$21.00
-PWM	Integrated pulse width modulated hydraulic motor. (206 and 304 motors only)	\$1,234.00

MAX SERIES HYDRAULIC CENTRIFUGAL PUMPS

- Designed from the ground up for today's demanding applications.
- Each model is engineered for maximum reliability and performance.
- A durable e-coat finish provides extra corrosion resistance on all surfaces inside and out.
- The 4000 psi high efficiency pressure plated gear motors provide higher output with less oil flow.
- The impellers are designed to develop higher pressures at lower shaft speeds.
- A splined motor to pump shaft connection strengthens the power train while allowing for easy repair and maintenance.
- Oversized bearings round out the list of features for long, trouble free life.

650 MAX SERIES

1-1/2" Suction x 1-1/4" Discharge



FMC-650F-HYD

FMC-650F-HYD-PWM

MODEL	EDP	DESCRIPTION	LBS	PRICE
FMC-650-HYD	49951	E-coated cast iron centrifugal driven by a 14.5 GPM hydraulic motor. Max. flow: 140 GPM Max. pressure: 160 PSI	39	\$2,208.00
FMC-650F-HYD	49954	E-coated cast iron centrifugal driven by a 14.5 GPM hydraulic motor. 220 X 200 flange and 1-1/2" X 1-1/4" NPT Max. flow: 170 GPM Max. pressure: 160 PSI	39	\$2,367.00
FMC-650FS-HYD	50035	316 stainless steel centrifugal driven by a 14.5 GPM hydraulic motor. 220 X 200 flange and 1-1/2" X 1-1/4" NPT Max. flow: 170 GPM Max. pressure: 160 PSI	39	\$3,465.00
FMC-650-HYD-LM	49968	Pump less motor for FMC-650-HYD.	32	\$1,652.00
FMCS		Silicon carbide shaft seal for abrasives.		\$122.00
-SI		316 Stainless steel impeller. (standard in FS models)		\$270.00
-PWM		Integrated pulse width modulated hydraulic motor.		\$1,488.00

See pages B-27 and B-34 for parts.



Oasis WetSeal Accessories

MODEL	EDP	DESCRIPTION	LBS	PRICE
OASIS-RES	45281	External wetseal reservoir	8	\$694.50

650

MAX SERIES



1-1/2" Suction x 1-1/4" Discharge

FMCWS-650FS-HYD

MODEL	EDP	DESCRIPTION	LBS	PRICE
FMCWS-650F-HYD	50026	E-coated cast iron centrifugal driven by a 14.5 GPM hydraulic motor. 220 X 200 flange and 1-1/2" X 1-1/4" NPT Max. flow: 170 GPM Max. pressure: 160 PSI	49	\$3,337.00
FMCWS-650FS-HYD	50041	316 stainless steel centrifugal driven by a 14.5 GPM hydraulic motor. 220 X 200 flange and 1-1/2" X 1-1/4" NPT Max. flow: 170 GPM Max. pressure: 160 PSI	49	\$4,311.00
FMCWS-650F-HYD-LM	50019	Pump less motor for FMCWS-650F-HYD.	42	\$2,781.00
-SI		316 Stainless steel impeller. (standard in FS models)		\$270.00
-PWM		Integrated pulse width modulated hydraulic motor.		\$1,488.00

See pages B-27 and B-34 for parts.

750

MAX SERIES



300 Flange Suction x 220 Flange Discharge

FMC-750F-HYD

MODEL	EDP	DESCRIPTION	LBS	PRICE
FMC-750F-HYD-M22	50020	E-coated cast iron centrifugal driven by a 18 GPM hydraulic motor. Max. flow: 290 GPM Max. pressure: 150 PSI	72	\$4,346.00
FMC-750F-HYD-M25	50021	E-coated cast iron centrifugal driven by a 20 GPM hydraulic motor. Max. flow: 290 GPM Max. pressure: 150 PSI	72	\$4,346.00
FMC-755FS-HYD-M22	50015	316 Stainless steel centrifugal driven by a 18 GPM hydraulic motor. Max. flow: 290 GPM Max. pressure: 150 PSI		\$6,354.00
FMC-750F-HYD-LM	50025	Pump less motor for FMC-750F-HYD-MXX	65	\$3,130.00
-SI		316 Stainless steel impeller (standard on FMC-755FS models)		\$567.00
-PWM		Integrated pulse width modulated hydraulic motor. (M22 motors only)		\$1,708.00

See pages B-27 and B-35 for parts.

855

MAX SERIES



300 Flange Suction x 300 Flange Discharge

FMC-855F-HYD

MODEL	EDP	DESCRIPTION	LBS	PRICE
FMC-855F-HYD	50001	E-coated cast iron centrifugal driven by a 23 GPM hydraulic motor. Max. flow: 345 GPM Max. pressure: 150 PSI	96	\$8,403.00

See pages B-27 and B-35 for parts.

PTO BELT DRIVEN CENTRIFUGAL PUMPS

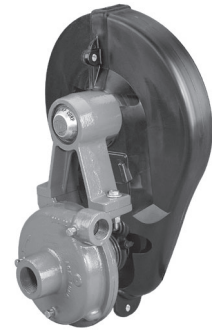

1-1/4" Suction x 1" Discharge

MODEL	EDP	DESCRIPTION	LBS	PRICE
PTOC-600-6SP	47620	Cast iron centrifugal for direct mount on 6 spline, 1-3/8", 540 RPM PTO shaft. Max. flow: 65 GPM Max. pressure: 80 PSI	45	\$1,761.00
PTOC-600-QC	47640	Cast iron centrifugal with quick coupler for direct mount on 6 spline, 1-3/8", 540 RPM PTO shaft. Max. flow: 65 GPM Max. pressure: 80 PSI	46	\$1,782.00
PTOC-600-B	48400	Cast iron centrifugal with 1" stub shaft and mounting base for trailer mount with a 540 RPM drive shaft. Max. flow: 65 GPM Max. pressure: 80 PSI	42	\$1,782.00
PTOC-1000-21SP	47800	Cast iron centrifugal for direct mount on 21 spline, 1-3/8", 1000 RPM PTO shaft. Max. flow: 65 GPM Max. pressure: 80 PSI	43	\$1,788.00
PTOC-1000-20SP	47810	Cast iron centrifugal for direct mount on 20 spline, 1-3/4", 1000 RPM PTO shaft. Max. flow: 65 GPM Max. pressure: 80 PSI	45	\$1,846.00
PTOC-1000-B	48505	Cast iron centrifugal with 1" stub shaft and mounting base for trailer mount with a 1000 RPM drive shaft. Max. flow: 65 GPM Max. pressure: 80 PSI	40	\$1,782.00
FMC-MIA	47000	Cast iron centrifugal pump only for PTOC models.	18	\$732.00

See page B-36 parts and sub-assemblies.

Options for PTOC Pumps

OPTION	DESCRIPTION	ADD
PTOCSC	Silicon carbide shaft seal for abrasives.	\$103.00
-CI	Cast iron impeller.	\$100.00
-SS	Stainless steel fitted package including capscrews, and pipe plugs.	\$21.00

PTO Shaft Options



-6SPQC

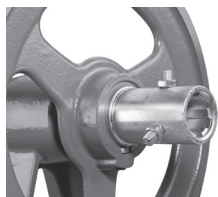

-6SP

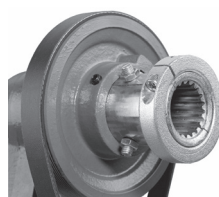

-20SP

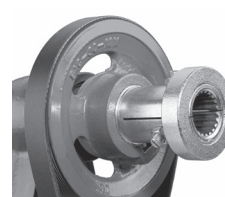

-21SP

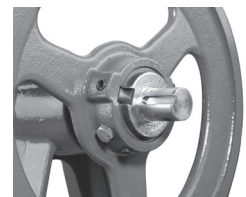

-B

150 SERIES **HIGH PERFORMANCE**



1-1/2" Suction x 1-1/4" Discharge

MODEL	EDP	DESCRIPTION	LBS	PRICE
PTOC-150-600-6SP	48404	Cast iron centrifugal for direct mount on 6 spline, 1-3/8", 540 RPM PTO shaft. Max. flow: 100 GPM Max. pressure: 110 PSI	51	\$1,980.00
PTOC-150-600-6SPQC	48403	Cast iron centrifugal with quick coupler for direct mount on 6 spline, 1-3/8", 540 RPM PTO shaft. Max. flow: 100 GPM Max. pressure: 110 PSI	51	\$2,001.00
PTOC-150-600-B	48402	Cast iron centrifugal with 1" stub shaft and mounting base for trailer mount with a 540 RPM drive shaft. Max. flow: 100 GPM Max. pressure: 110 PSI	52	\$2,001.00
PTOC-150-1000-21SP	47802	Cast iron centrifugal for direct mount on 21 spline, 1-3/8", 1000 RPM PTO shaft. Max. flow: 100 GPM Max. pressure: 110 PSI	48	\$2,007.00
PTOC-150-1000-20SP	47812	Cast iron centrifugal for direct mount on 20 spline, 1-3/4", 1000 RPM PTO shaft. Max. flow: 100 GPM Max. pressure: 110 PSI	50	\$2,065.00
PTOC-150-1000-B	48506	Cast iron centrifugal with 1" stub shaft and mounting base for trailer mount with a 1000 RPM drive shaft. Max. flow: 100 GPM Max. pressure: 110 PSI	45	\$2,001.00
FMC-150-MIA	47008	Cast iron centrifugal pump only for PTOC-150 models.	23	\$740.00

See pages B-36 and B-37 for parts and sub-assemblies.



-PI Option
Poly Impeller



-CI Option
Cast Impeller



SC Option

Options for PTOC-150 Pumps

OPTION	DESCRIPTION	ADD
PTOCSC	Silicon carbide shaft seal for abrasives.	\$103.00
150F	Flanged pump ports for 150 series models: Inlet 1-1/2" NPT & 220 full port flange Outlet 1-1/4" NPT & 200 standard port flange.	\$69.00
-CI	Cast iron impeller.	\$100.00
-PI	Polypropylene impeller for 150 series models.	\$45.00
-SI	316 Stainless steel impeller.	\$270.00
-SS	Stainless steel fitted package including impeller nut, capscrews, and pipe plugs.	\$21.00

GASOLINE ENGINE DRIVEN CENTRIFUGAL PUMPS



1" Suction x 3/4" Discharge

GE-85SP-HONDA

GE-75-HONDA

MODEL	EDP	DESCRIPTION	LBS	PRICE
GE-75-LE	60010	Polypropylene centrifugal pump less engine. Mounts directly on 5/8" keyed engine shaft. Max. flow: 25 GPM Max. pressure: 70 PSI	5	\$381.00
GE-75-HONDA	60015	GE-75 pump mounted on 2.8 net HP Honda.	31	\$2,098.00
GE-85-LE	60011	Polypropylene centrifugal pump less engine. Mounts directly on 3/4" keyed engine shaft. Max. flow: 24 GPM Max. pressure: 65 PSI	5	\$381.00
GE-85-LE-50	60009	Bulk package containing 50 each GE-85-LE pumps.	200	\$19,072.00
GE-85-HONDA	60014	GE-85 pump mounted on 4.8 HP Honda.	37	\$2,098.00
GE-85-KOHLER	60013	GE-85 pump mounted on 4.5 HP Kohler.	53	\$2,048.00
GE-85SP-LE	60031	Polypropylene self-priming centrifugal pump less engine. Mounts directly on 3/4" keyed engine shaft. Max. flow: 24 GPM Max. pressure: 65 PSI	7	\$434.00
GE-85SP-LE-30	60040	Bulk package containing 30 each GE-85SP-LE pumps.	180	\$13,097.00
GE-85SP-HONDA	60033	GE-85SP pump mounted on 4.8 HP Honda.	39	\$2,151.00
GE-85SP-KOHLER	60035	GE-85SP pump mounted on 4.5 HP Kohler.	39	\$2,101.00
GESC		Silicon carbide seal adder.		\$103.00

See page B-38 for parts.

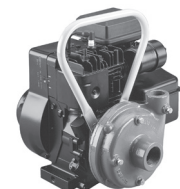

GE-100-A

1-1/4" Suction x 1" Discharge

MODEL	EDP	DESCRIPTION	LBS	PRICE
GE-100-A LE	60021	Cast iron centrifugal pump less engine. Mounts directly on 5/8" UNF threaded engine shaft. Max. flow: 50 GPM Max. pressure: 50 PSI	20	\$850.72
GE-100-A	60400	GE-100-A pump mounted on 3.5 HP Briggs & Stratton.	44	\$1,849.00

See page B-38 for parts.

All GE-660 models now standard with thermoplastic impeller.
See Product Update 21 for complete details.



1-1/2" Suction x 1-1/4" Discharge

GE-660-HONDA

MODEL	EDP	DESCRIPTION	LBS	PRICE
GE-660-LE	61160	Cast iron centrifugal pump less engine. Mounts directly on 3/4" keyed engine shaft. Thermoplastic impeller. Max. flow: 110 GPM Max. pressure: 120 PSI	20	\$782.00
GE-660-LE-EC 	61169	E-Coated cast iron centrifugal pump less engine. Mounts directly on 3/4" keyed engine shaft. Thermoplastic impeller. Max. flow: 110 GPM Max. pressure: 120 PSI	20	\$839.00
GE-660-HONDA	61163	GE-660 pump mounted on 4.8 net HP Honda.	60	\$2,649.00
GE-650-LE	61151	Cast iron centrifugal pump less engine. Mounts directly on 5/8" UNF threaded engine shaft. Max. flow: 110 GPM Max. pressure: 120 PSI	27	\$967.00
GESC (660)		Silicon carbide seal adder for GE-660 models.		\$103.00
-CI		Cast iron impeller for GE-660 only.		\$100.00
-ES		Electric start engine for GE-660-HONDA only.		CALL

See page B-39 for parts.



2" Suction x 1-1/2" Discharge

GE-860-HONDA

MODEL	EDP	DESCRIPTION	LBS	PRICE
GE-860-LE	61203	Cast iron centrifugal pump less engine. Mounts directly on 1" keyed engine shaft. Max. flow: 140 GPM Max. pressure: 140 PSI	29	\$1,530.00
GE-860-HONDA	61207	GE-860 pump mounted on 7.9 net HP Honda.	115*	\$4,606.00
GE-800-LE	61205	Cast iron centrifugal pump less engine. Mounts directly on 1" UNF threaded engine shaft. Max. flow: 140 GPM Max. pressure: 140 PSI	40	\$1,606.00
GESG		Silicon graphite seal adder.		\$179.00
-ES		Electric start engine for GE-860-HONDA.		CALL

* This item only ships by truck line.
See page B-39 for parts.



2-1/2" Suction x 2" Discharge

GE-1600

MODEL	EDP	DESCRIPTION	LBS	PRICE
GE-1600-LE	61211	Cast iron centrifugal pump less engine. Mounts directly on 1" UNF threaded engine shaft. Max. flow: 280 GPM Max. pressure: 120 PSI	40	\$2,130.00
GE-1600-VANGUARD	61210	GE-1600 pump mounted on 16HP Vanguard engine.	135	\$7,739.00

See page B-39 for parts.

FRAME MOUNTED CENTRIFUGAL PUMPS



Counter Clockwise Rotation (when facing shaft)

FMC-CW-75

MODEL	EDP	MAX FLOW	MAX PRESSURE	LBS	PRICE
FMC	46800	70 GPM	130 PSI	18	\$716.00
FMC-150	46804	130 PSI	130 PSI	23	\$724.00
FMC-150FS	46830	135 GPM	120 PSI	19	\$1,948.00
FMC-150SP	46820	120 GPM	120 PSI	37	\$1,297.00
FMC-650	47050	140 GPM	160 PSI	28	\$1,496.00
FMC-650F	47052	140 GPM	160 PSI	28	\$1,655.00
FMC-650FS	50042	140 GPM	160 PSI	28	\$2,753.00
FMCWS-650	47054	140 GPM	160 PSI	48	\$2,466.00
FMCWS-650F	47057	140 GPM	160 PSI	48	\$2,625.00
FMCWS-650FS	50043	140 GPM	160 PSI	48	\$3,723.00
FMC-200	47403	200 GPM	120 PSI	24	\$955.00
FMC-200SS-X	47460	200 GPM	120 PSI	24	\$1,682.00
FMC-750F	47070	290 GPM	150 PSI	66	\$2,828.00

See pages B-40 through B-41 for parts.

Clockwise Rotation (when facing shaft)

MODEL	EDP	MAX FLOW	MAX PRESSURE	LBS	PRICE
FMC-CW-75	46825	25 GPM	100 PSI	11	\$651.00
FMC-CW-75SP	46821	25 GPM	100 PSI	13	\$704.00
FMC-CW	47190	70 GPM	130 PSI	18	\$716.00
FMC-CW-150	47200	80 GPM	100 PSI	20	\$724.00
FMC-CW-650	47060	140 GPM	160 PSI	28	\$1,496.00
FMCWS-CW-650	47058	140 GPM	160 PSI	48	\$2,466.00
FMC-CW-200	47400	200 GPM	120 PSI	24	\$955.00
FMC-CW-800-DRB	47550	180 GPM	170 PSI	42	\$2,027.00

See pages B-42 and B-43 for parts.

Seal and Port Options for FMC and FMC-CW Pumps

OPTION	DESCRIPTION	ADD
FMCS	Silicon carbide shaft seal for abrasives.	\$103.00
FMCS-650	Silicon carbide seal for FMC-650 models.	\$122.00
FMCSG	Silicon graphite seal for FMC-CW-800-DRB.	\$179.00
150F	Inlet 1-1/2" NPT & 220 full port flange x Outlet 1-1/4" NPT & 200 standard port flange (CCW only).	\$69.00
650F	Inlet 1-1/2" NPT & 220 full port flange Outlet 1-1/4" NPT & 200 standard port flange (CCW only).	\$159.00
200F	Flanged pump ports: 300 standard port flange x 220 full port flange (CCW only).	\$159.00



FMC-150



FMC-650



FMCWS-650FS



FMC-750

	SUCTION	DISCHARGE	MATERIAL	FEATURE	SHAFT DIA
	1-1/4" NPT	1" NPT	Cast Iron		5/8"
	1-1/2" NPT	1-1/4" NPT	Cast Iron		5/8"
	220 Flange & 1-1/2" NPT	1-1/4" NPT	316 Stainless Steel		5/8"
	1-1/2" NPT	1-1/4" NPT	Cast Iron	Self-Priming	5/8"
	1-1/2" NPT	1-1/4" NPT	E-Coated Cast Iron		7/8"
	220 Flange & 1-1/2" NPT	200 Flange & 1-1/4" NPT	E-Coated Cast Iron		7/8"
	220 Flange & 1-1/2" NPT	200 Flange & 1-1/4" NPT	316 Stainless Steel		7/8"
	1-1/2" NPT	1-1/4" NPT	E-Coated Cast Iron		7/8"
	220 Flange & 1-1/2" NPT	200 Flange & 1-1/4" NPT	E-Coated Cast Iron		7/8"
	220 Flange & 1-1/2" NPT	200 Flange & 1-1/4" NPT	316 Stainless Steel		7/8"
	2" NPT	1-1/2" NPT	E-Coated Cast Iron		5/8"
	2" NPT	1-1/2" NPT	316 Stainless Steel	Heavy-duty -X	3/4"
	300 Flange	220 Flange	E-Coated Cast Iron		7/8"

	SUCTION	DISCHARGE	MATERIAL	FEATURE	SHAFT DIA
	1" NPT	3/4" NPT	Polypropylene		5/8"
	1" NPT	3/4" NPT	Polypropylene	Self-Priming	5/8"
	1-1/4" NPT	1" NPT	Cast Iron		5/8"
	1-1/2" NPT	1-1/4" NPT	Cast Iron		5/8"
	1-1/2" NPT	1-1/2" NPT	E-Coated Cast Iron		7/8"
	1-1/2" NPT	1-1/4" NPT	E-Coated Cast Iron		7/8"
	2" NPT	1-1/2" NPT	Cast Iron		5/8"
	2" NPT	1-1/2" NPT	Cast Iron		7/8"

Other Options for FMC and FMC-CW Pumps

OPTION	DESCRIPTION	ADD
-CI	Cast iron impeller.	\$100.00
-PI	Polypropylene impeller for 150 series models (CCW only).	\$45.00
-SI	316 Stainless steel impeller for 150 and 200 (CCW only) and 650 series models.	\$270.00
-X	Heavy-duty -X version of FMC-CW-150, FMC-200, or FMC-CW-200. Features 3/4" diameter shaft and heavy duty bearings.	\$66.00
-SS	Stainless steel fitted package including impeller nut, capscrews and pipe plugs.	\$21.00
-MIA	MIA-Mounting frame machined for idler arm.	\$16.00

MAGNETIC CLUTCH CENTRIFUGAL PUMPS



FMC-MAG-D



FMCWS-650FS-MAG-D



FMC-200SS-MAG-DX

Counter Clockwise Rotation (when facing shaft)

MODEL	EDP	MAX FLOW	MAX PRESSURE	LBS	PRICE
FMC-MAG-D	47040	70 GPM	130 PSI	23	\$1,373.00
FMC-150-MAG-D	47030	130 GPM	120 PSI	25	\$1,381.00
FMC-150SP-MAG-D	47037	120 GPM	120 PSI	39	\$1,954.00
FMC-650-MAG-D	47055	140 GPM	160 PSI	35	\$2,370.00
FMC-650F-MAG-D	47056	170 GPM	160 PSI	35	\$2,529.00
FMC-650FS-MAG-D	47076	170 GPM	160 PSI	35	\$3,627.00
FMCWS-650F-MAG-D	47063	170 GPM	160 PSI	35	\$3,499.00
FMCWS-650FS-MAG-D	47068	170 GPM	160 PSI	35	\$4,597.00
FMC-200-MAG-D	47430	200 GPM	120 PSI	28	\$1,688.00
FMC-200SS-MAG-DX	47433	200 GPM	120 PSI	26	\$2,415.00

See pages B-40 through B-41 for parts.

Clockwise Rotation (when facing shaft)

MODEL	EDP	MAX FLOW	MAX PRESSURE	LBS	PRICE
FMC-CW-MAG-D	47195	70 GPM	130 PSI	23	\$1,373.00
FMC-CW-150-MAG-D	47237	80 GPM	100 PSI	25	\$1,381.00
FMC-CW-150-MAG-DX3	47250	80 GPM	100 PSI	25	\$1,447.00
FMC-CW-650-MAG-D	47061	140 GPM	160 PSI	35	\$2,370.00
FMC-CW-200-MAG-D	47440	200 GPM	120 PSI	29	\$1,680.00
FMC-CW-800-MAG-D	47570	180 GPM	170 PSI	45	\$3,447.00

See pages B-41 through B-43 for parts.

Seal and Port Options for FMC and FMC-CW Pumps



OPTION	DESCRIPTION	ADD
FMCS	Silicon carbide shaft seal for abrasives.	\$103.00
FMCS-650	Silicon carbide seal for FMC-650 models.	\$122.00
FMCSG	Silicon graphite seal for FMC-CW-800-DRB.	\$179.00
150F	Inlet 1-1/2" NPT & 220 full port flange x Outlet 1-1/4" NPT & 200 standard port flange (CCW only).	\$69.00
650F	Inlet 1-1/2" NPT & 220 full port flange Outlet 1-1/4" NPT & 200 standard port flange (CCW only).	\$159.00
200F	Flanged pump ports: 300 standard port flange x 220 full port flange (CCW only).	\$159.00



FMC-CW-150-MAG-DX3



FMC-CW-800-MAG-D

	SUCTION	DISCHARGE	MATERIAL	FEATURE
	1-1/4" NPT	1" NPT	Cast Iron	
	1-1/2" NPT	1-1/4" NPT	Cast Iron	
	1-1/2" NPT	1-1/4" NPT	Cast Iron	Self-Priming
	1-1/2" NPT	1-1/4" NPT	E-Coated Cast Iron	
	220 Flange & 1-1/2" NPT	200 Flange & 1-1/4" NPT	E-Coated Cast Iron	
	220 Flange & 1-1/2" NPT	200 Flange & 1-1/4" NPT	316 Stainless Steel	
	220 Flange & 1-1/2" NPT	200 Flange & 1-1/4" NPT	E-Coated Cast Iron	
	220 Flange & 1-1/2" NPT	200 Flange & 1-1/4" NPT	316 Stainless Steel	
	2" NPT	1-1/2" NPT	Cast Iron	
	2" NPT	1-1/2" NPT	316 Stainless Steel	Heavy-duty -X version

	SUCTION	DISCHARGE	MATERIAL	FEATURE
	1-1/4" NPT	1" NPT	Cast Iron	
	1-1/2" NPT	1-1/4" NPT	Cast Iron	
	1-1/2" NPT	1-1/4" NPT	Cast Iron	for Spray-Coupe models: 3430,3440,3630, 3640, 4440, and 4640.
	1-1/2" NPT	1-1/4" NPT	E-Coated Cast Iron	
	2" NPT	1-1/2" NPT	Cast Iron	
	2" NPT	1-1/2" NPT	Cast Iron	

Other Options for FMC and FMC-CW Pumps

OPTION	DESCRIPTION	ADD
-CI	Cast iron impeller.	\$100.00
-PI	Polypropylene impeller for 150 series models (CCW only).	\$45.00
-SI	316 Stainless steel impeller for 150 and 200 (CCW only) and 650 series models.	\$270.00
-X	Heavy-duty -X version of FMC-CW-150, FMC-200, or FMC-CW-200. Features 3/4" diameter shaft and heavy duty bearings.	\$66.00
-SS	Stainless steel fitted package including impeller nut, capscrews and pipe plugs.	\$21.00
-MIA	MIA-Mounting frame machined for idler arm.	\$16.00

ELECTRIC MOTOR DRIVEN PUMPS

Ace Pump Corporation offers a full line of electric motor driven pumps from 1/2 HP to 15 HP.



MPH-100-75SE

Features:

- A compact design with close-coupled motor for easy service and replacement
- Straight centrifugal design requires flooded suction
- Standard NPT ports
- Cast iron housing and impeller
- Optional TEFC motor available for most models
- Standard seal rated up to 180° F
- Optional high heat seals available
- Optional severe duty silicon carbide seal available

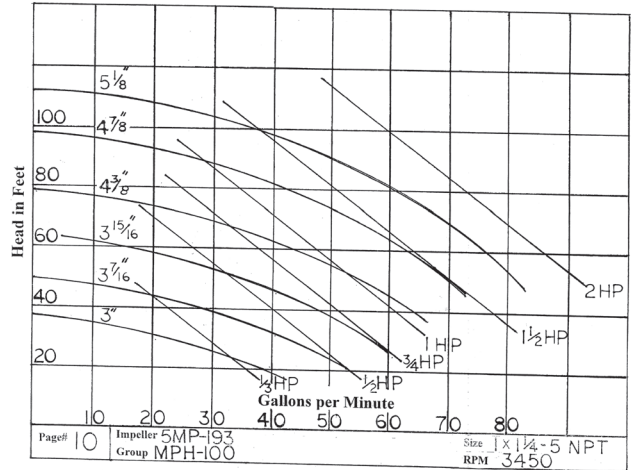

What happened to the ACH-55-1PH-TEFC?

- The ACH-55-1PH-TEFC has been replaced by MPH-100-75SE.

MPH-100			1-1/4" X 1"			All Cast-Iron		
HP	MAX PSI	MAX GPM	3PH 208-230/460V			1PH 115/230V		
			MODEL	LBS	PRICE	MODEL	LBS	PRICE
1/2	26	60	MPH-100-50T	38	\$2,122.00	MPH-100-50S	38	\$1,948.00
3/4	32	68	MPH-100-75T	42	\$2,378.00	MPH-100-75S	42	\$2,187.00
3/4	26	60	MPH-100-75TE	48	\$3,169.00	*MPH-100-75SE	48	\$2,562.00
1	41	80	MPH-100-100T	44	\$2,481.00	MPH-100-100S	44	\$2,303.00
1-1/2	45	85	MPH-100-150T	49	\$3,120.00	MPH-100-150S	49	\$2,962.00
2	45	85	MPH-100-200T	55	\$3,506.00	MPH-100-200S	57	\$3,444.00

MFP-100			1-1/4" X 1"			All Cast-Iron		
HP	MAX PSI	MAX GPM	3PH 208-230/460V			1PH 115/230V		
			MODEL	LBS	PRICE	MODEL	LBS	PRICE
1	34	36	MFP-100-100T	45	\$2,790.00	MFP-100-100S	45	\$2,642.00
1-1/2	45	47	MFP-100-150T	53	\$3,588.00	MFP-100-150S	49	\$3,598.00
2	56	56	MFP-100-200T	56	\$4,140.00	MFP-100-200S	52	\$3,937.00
3	63	62	MFP-100-300T	65	\$5,105.00	MFP-100-300S	70	\$4,988.00

MPH-125			1-1/2" X 1-1/4"			All Cast-Iron		
HP	MAX PSI	MAX GPM	3PH 208-230/460V			1PH 115/230V		
			MODEL	LBS	PRICE	MODEL	LBS	PRICE
3/4	26	60	MPH-125-75T	44	\$2,661.00	MPH-125-75S	45	\$2,468.00
1	34	63	MPH-125-100T	45	\$2,762.00	MPH-125-100S	47	\$2,616.00
1-1/2	42	68	MPH-125-150T	60	\$3,539.00	MPH-125-150S	50	\$3,379.00
2	46	76	MPH-125-200T	63	\$3,927.00	MPH-125-200S	58	\$3,836.00

* Replaces the ACH-55-1PH-TEFC pump
Pumps

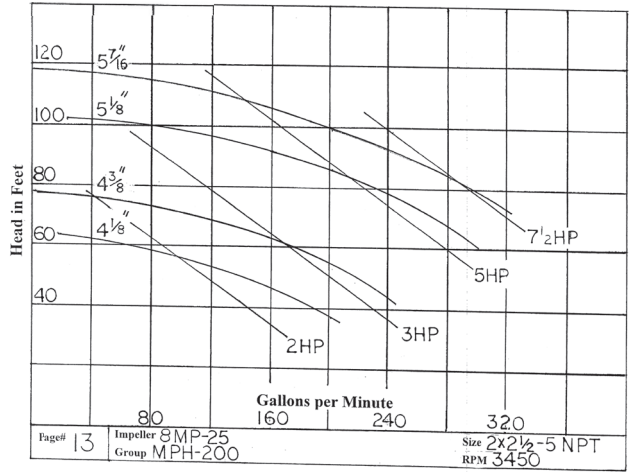
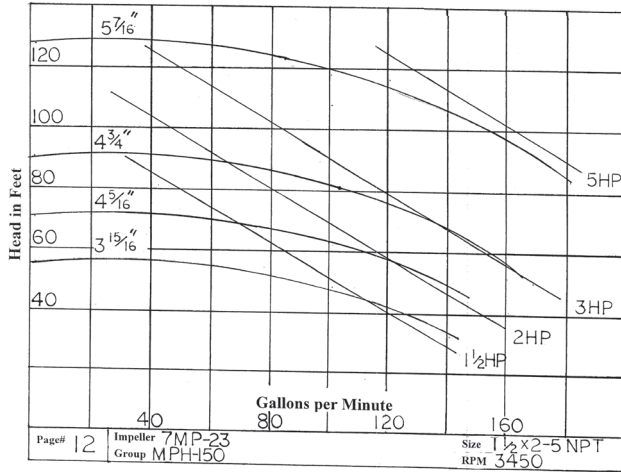
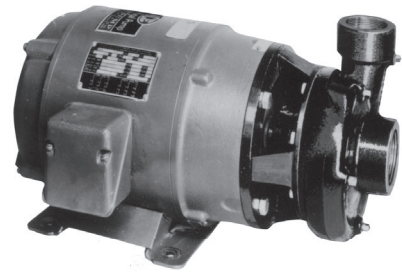
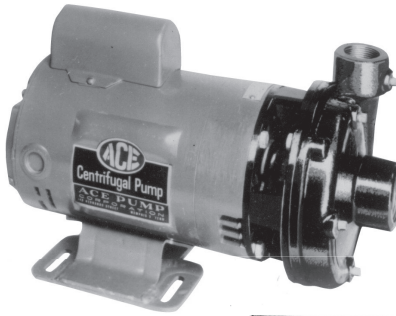

MPH-150			2" X 1-1/2"			All Cast-Iron		
HP	MAX PSI	MAX GPM	3PH 208-230/460V			1PH 115/230V		
			MODEL	LBS	PRICE	MODEL	LBS	PRICE
1-1/2	20	140	MPH-150-150T	63	\$3,597.00	MPH-150-150S	55	\$3,390.00
2	28	160	MPH-150-200T	66	\$3,988.00	MPH-150-200S	61	\$3,945.00
3	38	172	MPH-150-300T	74	\$4,133.00	MPH-150-300S	96	\$6,049.00
5	52	183	MPH-150-500T	96	\$4,724.00	MPH-150-500S	111	\$7,521.00

MPA-150			2" X 1-1/2"			All Cast-Iron		
HP	MAX PSI	MAX GPM	3PH 208-230/460V			1PH 115/230V		
			MODEL	LBS	PRICE	MODEL	LBS	PRICE
5	63	125	MPA-150-500T	106	\$5,121.00	MPA-150-500S	121	\$8,303.00
7-1/2	76	150	MPA-150-750T	113	\$5,590.00	MPA-150-750S	155	\$9,885.00
10	89	175	MPA-150-1000T	148	\$6,640.00	MPA-150-1000S	174	\$12,134.00
15	115	200	MPA-150-1500T	156	\$7,128.00			

MPH-200			2-1/2" X 2"			All Cast-Iron		
HP	MAX PSI	MAX GPM	3PH 208-230/460V			1PH 115/230V		
			MODEL	LBS	PRICE	MODEL	LBS	PRICE
2	19	195	MPH-200-200T	70	\$4,133.00	MPH-200-200S	70	\$4,596.00
3	34	240	MPH-200-300T	77	\$4,340.00	MPH-200-300S	99	\$5,901.00
5	43	280	MPH-200-500T	99	\$4,874.00	MPH-200-500S	114	\$7,396.00
7-1/2	51	318	MPH-200-750T	106	\$5,316.00			

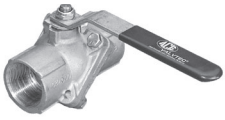

ACE/VALVTEC BALL VALVES

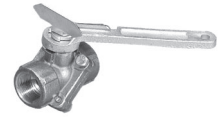

CAST IRON VALVES - 1/4 TURN ACTUATED

CAST IRON VALVES - RATCHET ACTUATED

303 STAINLESS STEEL BALL				303 STAINLESS STEEL BALL			
SIZE	MODEL	EDP	PRICE	SIZE	MODEL	EDP	PRICE
*1/2"	1604CSQ	90500	\$370.00	*1/2"	1604CSW	90640	\$484.00
3/4"	1606CSQ	90520	\$383.00	3/4"	1606CSW	90660	\$616.00
1"	1608CSQ	90540	\$584.00	1"	1608CSW	90680	\$630.00
1-1/4"	1610CSQ	90560	\$472.00	1 1/4"	1610CSW	90700	\$630.00
1-1/2"	1612CSQ	90580	\$484.00	1 1/2"	1612CSW	90720	\$684.00
2"	1616CSQ	90600	\$678.00	2"	1616CSW	90740	\$780.00

ALUMINUM VALVES - 1/4 TURN ACTUATED

ALUMINUM VALVES - RATCHET ACTUATED

303 STAINLESS STEEL BALL				303 STAINLESS STEEL BALL			
SIZE	MODEL	EDP	LIST	SIZE	MODEL	EDP	PRICE
*1/2"	1604ASQ	90260	\$451.00	*1/2"	1604ASW	90380	\$538.00
3/4"	1606ASQ	90280	\$468.00	3/4"	1606ASW	90400	\$565.00
1"	1608ASQ	90300	\$482.00	1"	1608ASW	90420	\$584.00
1 1/4"	1610ASQ	90320	\$505.00	1 1/4"	1610ASW	90440	\$604.00
2"	1616ASQ	90360	\$700.00	2"	1616ASW	90480	\$817.00

BRONZE VALVES - 1/4 TURN ACTUATED

BRONZE VALVES - RATCHET ACTUATED

303 STAINLESS STEEL BALL				303 STAINLESS STEEL BALL			
SIZE	MODEL	EDP	PRICE	SIZE	MODEL	EDP	PRICE
*1/2"	1604BSQ	90020	\$472.00	*1/2"	1604BSW	90140	\$578.00
3/4"	1606BSQ	90040	\$565.00	3/4"	1606BSW	90160	\$711.00
1"	1608BSQ	90060	\$578.00	1"	1608BSW	90180	\$726.00

* 1/2" size is a full port valve.

Unless specified, ratchet valves will be shipped in a "with-flow", "right-hand" configuration. See diagram below.

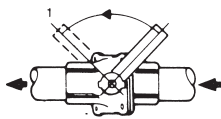

1. Left-Hand with-flow

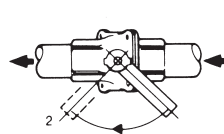

2. Right-Hand with-flow (standard)

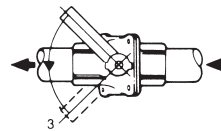

3. Left-Hand cross-flow

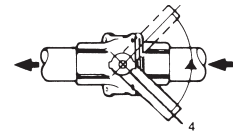

4. Right-Hand cross-flow

Repair Kits

PART NO.	EDP NO.	DESCRIPTION	REQ.	EACH
RK-1606S	91350	Repair kit for Series 16-1/2" and 3/4" valves		132.00
RK-1608S	91360	Repair kit for Series 16-1" valves		154.75
RK-1610S	91370	Repair kit for Series 16 1-1/4" valves		195.25
RK-1612S	91380	Repair kit for Series 16 1-1/2" valves		195.25
RK-1616S	91390	Repair kit for Series 16 1-1/2" valves		253.25

PUMP PARTS PRICING BY MODEL

BAC-75-HYD-200 Series, BAC-75-HYD-200N Series, BAC-75-HYD-200N5 Series, and BAC-75-HYD-200R Series Hydraulic Motor Repair Parts (202, 203, 204, 206, and 210 models)

PART NO	EDP NO	DESCRIPTION	REQ	EACH
RK-BAC-75-HYD-L	41374	Repair kit for 200 Series HYD motors, includes Teflon® lip seal 40153, two 41850, 42044, and 42030		72.25
BAC-75-200-TLS	40153	Seal, 200 Series HYD motor, Teflon® lip	1	56.25
40960	40960	Nut, 3/8" NC Jam type	1	0.75
41718	41718	Housing (for 202 motor)	1	205.25
41719	41719	Housing (for 203 motor)	1	205.25
41720	41720	Housing (for 204 motor)	1	205.25
41721	41721	Housing (for 206 motor)	1	205.25
41725	41725	Housing (for 210 motor)	1	217.00
41731	41731	Drive plate (all 200 and 200N series motors)	1	383.75
41733	41733	Drive plate (all 200R series motors)	1	377.00
41736	41736	Drive plate (all 200N5 series motors)	1	377.00
41737	41737	Drive plate (all 200N5-CD series motors)	1	413.50
41740	41740	End plate (202 and 203 motor), obsolete in 2018, now using 41742	1	350.50
41742	41742	End plate (200N series motors)	1	350.50
41743	41743	End plate (200R series motors)	1	350.50
41747	41747	End plate (200N5 series motors)	1	350.50
41748	41748	Gear (for 202 motor)	2	138.75
41749	41749	Gear (for 203 motor)	2	138.75
41750	41750	Gear (for 204 motor)	2	138.75
41751	41751	Gear (for 206 motor)	2	138.75
41755	41755	Gear (for 210 motor)	2	151.00
41758	41758	Drive shaft, 202 and 202N motors (extended shaft replaces previous shaft - no coupler required)	1	125.50
41759	41759	Drive shaft, 203 and 203N motors (extended shaft replaces previous shaft - no coupler required)	1	125.50
41761	41761	Drive shaft, 204 and 204N motors (extended shaft replaces previous shaft - no coupler required)	1	125.50
41764	41764	Drive shaft, 206 and 206N motors (extended shaft replaces previous shaft - no coupler required)	1	137.75
41766	41766	Drive shaft, 210 and 210N motors (extended shaft replaces previous shaft - no coupler required)	1	150.00
41780	41780	Spring (for 202 and 203 motors)	1	2.25
41790	41790	Check valve cap (for 202 and 203 motors)	1	40.75
41799	41799	Dowel pin (for 202 and 203 motors)	2	3.75
41800	41800	Dowel pin (for 204 motor)	2	3.75
41801	41801	Dowel pin (for 206 motor)	4	5.00
41805	41805	Dowel pin (for 210 motor)	4	5.00
41820	41820	Washer, Nylon (for 202 and 203 motors)	1	2.25
41850	41850	"O" Ring, housing seal	2	2.25
41899	41899	Cap screw, 1/4" N.C. x 1 1/8" Hex head for 202 and 203 motor	2	2.25
41900	41900	Cap screw, 1/4" N.C. x 1 1/2" Hex head for 204 and 206 motor	2	2.25
41905	41905	Cap screw, 1/4" N.C. x 2" Hex head for 210 motor	2	2.25
41262	41262	Cap screw, socket head for 200N5 and 204N5-CD motor	2	2.25
41264	41264	Cap screw, socket head for 203N5-CD motor	2	2.25
41918	41918	Dowel pin, drive shaft (for 202 motor)	1	2.25
41919	41919	Dowel pin, drive shaft (for 203 motor)	1	2.25
41920	41920	Dowel pin, drive shaft (for 204 motor)	1	2.25
41921	41921	Dowel pin, drive shaft (for 206 motor)	1	2.25
41925	41925	Dowel pin, drive shaft (for 210 motor)	1	2.25
41941	41941	Snap ring	2	1.00
41950	41950	Ball, reverse flow check (for 202 and 203 motors)	1	1.25
41961	41961	Ball bearing, 7/16" I.D.	1	53.00
41968	41968	Idler shaft (for 202 motor)	1	66.00
41969	41969	Idler shaft (for 203 motor)	1	66.00
41970	41970	Idler shaft (for 204 motor)	1	66.00
41971	41971	Idler shaft (for 206 motor)	1	66.00
41975	41975	Idler shaft (for 210 motor)	1	66.00
41980	41980	Retaining ring	2	2.25
41990	41990	Ball, idler shaft	1	2.25
42010	42010	Needle valve adjusting screw	1	29.75
42030	42030	#7500 3/8" N.C. Thread seal	1	9.25
42040	42040	Flat steel back-up washer	1	3.75
42041	42041	Seal check cap	1	23.25
42042	42042	Spring for seal check	1	2.25
42043	42043	Ball, coasting check	1	2.25
42044	42044	"O" Ring, coasting check	1	2.25
Parts below for 206-PWM only				
41256	41256	Cap screw, 5/16" N.C. x 3.5" socket head	2	2.25
41746	41746	End plate, 200 series PWM motors	1	350.50
74209	74209	O-ring, port sealing, manifold to motor	2	2.25
PWM-18-PRO-6	74222	Valve assembly, 12V proportional	1	890.75
PWM-18-PRV-11	74210	Valve assembly, pressure reducing	1	344.00
74235	74235	Protector, manual override, PWM-18-PRO-6	1	1.25
74230	74230	Nut, coil retainer for PWM-18-PRO-6	1	33.50
41445	41445	O-ring, coil nut	1	1.25
74225	74225	Coil, 12V for PWM-18-PRO-6	1	132.25
BAC-75-HYD-206P	41321	Motor, BAC-75-HYD-206-PWM, less manifold		723.00
PWM-1-206	74201	Mainfold assembly, 206-PWM, includes 74209, 41875, 41462, 74222, and 74210		1,256.75

BAC-75-HYD-300 Series, BAC-75-HYD-300A Series, and BAC-75-HYD-300N Series

Hydraulic Motor Repair Parts (304, 307, and 310 models)

PART NO.	EDP NO.	DESCRIPTION	REQ.	EACH
RK-BAC-75-HYD-300-L	41362	Repair kit for 300 Series HYD motors, includes Teflon® lip seal 40154, two 43130, 43290, and 43291		121.50
BAC-75-300-TLS	40154	Seal, 300 Series HYD motor, Teflon® lip	1	99.25
41860	41860	"O" Ring, seal retainer (for 310 motor)	1	2.25
43000	43000	Housing (for 310 motor)	1	241.50
43001	43001	Housing (for 307 motor)	1	241.50
43005	43005	Housing (for 304 motor)	1	218.50
43015	43015	Drive plate (for 300 series motors)	1	394.75
43016	43016	Drive plate (for 300A and 300N series motors)	1	418.75
43017	43017	Drive plate (for 300A-CD series motors with case drain option)	1	418.75
43020	43020	End plate (for 300 series motors)	1	387.00
43021	43021	End plate (for 300A series motors)	1	387.00
43022	43022	End plate (for 300N series motors)	1	387.00
43025	43025	End plate, #12 SAE ports	1	387.00
43031	43031	Gear (for 307 motor)	2	163.25
43035	43035	Gear (for 304 motor)	2	163.25
43039	43039	Drive shaft (for 310A and 310N motor)	1	258.00
43041	43041	Drive shaft (for 307 motor)	1	258.00
43043	43043	Drive shaft (for 307A motor)	1	252.50
43045	43045	Drive shaft (for 304 motor)	1	240.25
43046	43046	Drive shaft (for 304A and 304N motor)	1	240.25
43050	43050	Steel seal retainer (for 310 motor)	1	40.75
43051	43051	Steel seal retainer (for 304 motor)	1	40.75
43056	43056	Perforated spacer, seal/bearing (for 300A and 300N series motors)	1	36.50
43060	43060	Spring, reverse flow check	1	9.50
43080	43080	Dowel pin, housing (for 310 motor)	4	2.25
43081	43081	Dowel pin, housing (for 307 motor)	2	2.25
43085	43085	Dowel pin, housing (for 304 motor)	2	2.25
43130	43130	"O" Ring, housing seal (for 300 series motors)	2	2.25
43185	43185	Cap screw, 3/8" N.C. x 2" Hex head (for 304 motor)	4	2.50
43190	43190	Dowel pin, drive shaft (for 310 motor)	1	2.25
43191	43191	Dowel pin, drive shaft (for 307 motor)	1	2.25
43195	43195	Dowel pin, drive shaft (for 304 motor)	1	2.25
43200	43200	Snap ring (for 310 motor)	1	7.25
43205	43205	Snap ring, bearing (for 300 series motors)	1	7.25
43210	43210	Plunger	1	54.00
43220	43220	Ball bearing, drive shaft (for 310 motor)	1	66.00
43225	43225	Ball bearing, drive shaft (for 304 motor)	1	47.25
43230	43230	Idler shaft (for 310 motor)	1	71.75
43231	43231	Idler shaft (for 307 motor)	1	71.75
43235	43235	Idler shaft (for 304 motor)	1	71.75
43240	43240	Retainer ring	2	1.25
43250	43250	Ball, idler shaft (for 310 motor)	1	2.25
43255	43255	Ball, idler shaft (for 300 series motors)	1	2.25
43260	43260	Needle valve adjusting screw	1	54.00
43265	43265	Needle valve adjusting screw (for 300A series motors)	1	54.00
43266	43266	Needle valve adjusting screw (for 300N series motors)	1	54.00
43270	43270	Hex nut, needle valve	1	3.75
43275	43275	Cap, needle valve (for 300A series motors)	1	6.00
43276	43276	"O" Ring, needle cap (for 300A and 300N series motors)	1	1.75
43277	43277	Cap, needle valve (for 300N series motors)	1	6.00
43290	43290	"O" Ring, check valve cap (for 300 series motors)	1	2.25
43291	43291	1/2" Thread seal, needle valve	1	14.25
43292	43292	Flat steel back-up washer, needle valve	1	2.25
43300	43300	Plunger, coasting check (for 300 series motors)	1	14.25
43305	43305	Spring, coasting check (for 300 series motors)	1	16.75
43310	43310	"O" Ring, coasting check (for 300 series motors)	1	1.25
43315	43315	Valve cap, coasting check (for 300 series motors)	1	21.25
Parts below for 304-PWM motors only				
43023	43023	End plate, 300-PWM series motor	1	423.25
74205	74205	O-ring, port sealing, manifold to motor	2	2.25
PWM-18-PRO-11	74220	Valve assembly, 12V proportional	1	882.00
PWM-18-PRV-11	74210	Valve assembly, pressure reducing	1	344.00
41251	41251	Cap screw, 5/16" N.C. x 2.25" socket head	2	2.25
41445	41445	O-ring, #10 SAE fitting	1	1.25
BAC-78-10X10SAE	41467	Reverse check assembly, #10 SAE x #10 SAE	1	41.75
74235	74235	Protector, manual override, PWM-18-PRO	1	1.25
74230	74230	Nut, coil retainer for PWM-18-PRO	1	33.50
41445	41445	O-ring, coil nut	1	1.25
74225	74225	Coil, 12V for PWM-18-PRO	1	132.25
BAC-75-HYD-304P	41328	Motor, BAC-75-HYD-304-PWM, less manifold	1	1,100.25
PWM-1	74200	Manifold assembly, 304-PWM, includes both valves, manifold, and reverse check assembly	1	1,256.75

BAC-75-HYD-M Series

Hydraulic Motor Repair Parts (M16, M22, M25, and M30 models)

PART NO.	EDP NO.	DESCRIPTION	REQ.	EACH
RK-BAC-75-M	40138	Shaft seal repair kit, includes 43416, 43414, 43419, & 43418 (for standard M Series motors)		186.75
BAC-75-M-FKM	40164	Shaft seal repair kit, includes 43400, 43411, & 43416 (for M-CD Series motors with Case Drain)		73.75
43416	43416	Installation tool, shaft seal		22.00
43407	43407	Support ring, shaft seal (for M-CD Series motors with Case Drain)	1	9.50
43411	43411	Shaft seal, Viton (for M-CD Series motors with Case Drain)	1	51.75
43414	43414	Absorbent pad (for standard M series motors)	1	5.75
43417	43417	Drive plate, flange (for M-CD Series motors with Case Drain)	1	183.00
43419	43419	O-ring, flange (for standard M series motors)	1	1.75
43420	43420	Pin, motor assembly	4	1.25
43425	43425	Housing seal, front external	1	5.00
43430	43430	Anti-extrusion seal (for standard M Series motors)	2	3.75
43431	43431	Anti-extrusion seal (for M-CD Series motors with Case Drain)	2	3.75
43435	43435	Compensation seal (for standard M Series motors)	2	3.75
43436	43436	Compensation seal (for M-CD Series motors with Case Drain)	2	3.75
43440	43440	Housing seal, rear external	1	36.50
43445	43445	Cap, coasting check	1	27.50
43450	43450	O-ring, coasting check cap	1	0.60
43455	43455	Spring, coasting check	1	1.25
43460	43460	Ball, coasting check	1	1.25
43465	43465	End plate, cover (for standard M Series motors)	1	323.00
43466	43466	End plate, cover (for M30-CD and M16-CDE series motors)	1	315.50
43467	43467	End plate, cover (for M16-CD, M22-CD, and M25-CD motors)	1	315.50
43470	43470	Cap screw, motor assembly, hex head (for M16 motors)	4	5.00
43475	43475	Cap screw, motor assembly, hex head (for M22 & M25 motors)	4	11.00
43480	43480	Cap screw, motor assembly, hex head (for M30 motors)	4	24.50
Parts below are for PWM only				
PWM-18-PRO-18	74224	Valve assembly, 12V proportional, M16-PWM	1	1,234.75
PWM-18-PRO-20	74226	Valve assembly, 12V proportional, M22-PWM	1	1,234.75
43477	43477	Cap screw, motor assembly hex head, M16-PWM	4	8.50
43476	43476	Cap screw, motor assembly hex head, M22-PWM	4	11.00
74229	74229	Coil, 12V for PWM-18-PRO-18, M16-PWM	1	88.25
74228	74228	Coil, 12V for PWM-18-PRO-20, M22-PWM	1	177.50
74232	74232	Nut, coil attachment for PWM-18-PRO-20, M22-PWM	1	11.75

FMC-75-HYD and FMC-75SP-HYD 1" x 3/4" Poly Hydraulic Motor Driven Pumps



PART NO.	EDP NO.	DESCRIPTION	FMC-75-HYD	FMC-75SP-HYD	EACH
RK-GE-75	60840	Repair kit, includes seal 42730, 5 washers 30028, "O" Ring 40159, and "O" Ring 40017	1		85.75
RK-GE-75-IMP	60849	Repair kit, includes impeller 42710, seal 42730, 5 washers 30028, "O" Ring 40159, and "O" Ring 40017	1		157.50
RK-FMC-75SP	60842	Repair kit, includes seal 42730, 5 washers 30028, "O" Ring 40159, "O" Ring 40014, and "O" Ring 40012		1	97.50
RK-GE-75	60841	Repair kit, includes seal 42731, 5 washers 30028, "O" Ring 40159, and "O" Ring 40017	1		212.50
RK-FMCS-75SP	60843	Repair kit, includes seal 42731, 5 washers 30028, "O" Ring 40159, "O" Ring 40014, and "O" Ring 40012		1	224.25
FMC-75-HYD-LM	49774	Pump less motor, 200R series motors	1		913.00
FMC-75SP-HYD-LM	49695	Pump less motor, 200R series motors		1	966.00
BAC-53-P	41109	Pipe plug, 1/8" NPT, plastic	1		2.25
41122	41122	Pipe plug, fill/drain, 1/2" NPT, plastic		2	13.75
40191	40191	"O" Ring for 41122 fill/drain plugs		2	0.60
80250	80250	Cap screw, 3/8"-16 x 7/8", hex head	8		2.50
42237	42237	Cap screw, 5/16"-18 x 1-1/4", hex head		10	2.25
42701	42701	Washer, 3/8" flat	8		0.75
20730	20730	Washer, 5/16" flat		10	0.60
GE-12-75	42700	Volute, 3/4" x 1", polypropylene	1		152.00
GE-12-75SP	42708	Volute, 3/4" x 1", polypropylene		1	178.50
42240	42240	Cap screw, 1/4"-28 x 1", hex, stainless steel	1		3.75
30028	30028	Washer, sealing	5	5	2.25
GE-26-75	42710	Impeller, with keyway, polypropylene	1	1	71.75
42238	42238	Cap screw, 5/16"NF x 2-1/4"	4	4	3.50
BAC-7-75V	42730	Seal, 5/8", Viton® type rubber	1	1	57.25
BAC-75C-75V	42731	Seal, 5/8", Silicon Carbide/Viton® type rubber (optional)	1	1	184.00
40159	40159	"O" Ring, seal seat	1	1	1.25
40017	40017	"O" Ring, volute seal	1		16.00
40014	40014	"O" Ring, volute seal		1	16.00
40012	40012	"O" Ring, volute to diffuser seal		1	11.75
GE-14-75	42720	Bracket, polypropylene	1		161.00
GE-14-75SP	42725	Bracket, polypropylene		1	166.50
BAC-45	41010	Nut, hex, 3/8"	8		0.60
42270	42270	Nut, hex, 5/16"		10	0.75
BAC-14-75-HYD	40293	Mounting frame (for BAC-75-HYD-204R, 206R hydraulic motor)	1	1	314.00
BAC-54	41130	Slinger	1	1	2.25
BAC-33	40810	Snap ring, internal, BAC-14 mounting frame	2	2	2.25
BAC-37	40870	Bearing, BAC-6 driven shaft	2	2	23.25
BAC-32	40790	Snap ring, external, BAC-6 driven shaft	2	2	0.75
BAC-32-S	40795	Spacer for BAC-6 shaft	1	1	7.00
41082	41082	Key, 3/16" x 3/16" x 15/16"	1	1	1.25
BAC-6-75-HYD-SS	40048	Shaft, 5/8" Driven shaft with tang slot, stainless steel	1	1	150.00
S200	40161	Seal support spacer for 200 series hydraulic lip seal	1	1	11.75
BAC-75-HYD-204R	41437	4 GPM Hydraulic motor, reverse rotation, for open or closed-center systems with integrated needle valve	1	1	789.25
BAC-75-HYD-206R	41438	7 GPM Hydraulic motor, reverse rotation, for open or closed-center systems with integrated needle valve	1	1	771.75
41252	41252	Cap screw, 5/16" NC x 3 1/2" socket head (for 204R motors), SS	4	4	3.75
41259	41259	Cap screw, 5/16" NC x 3 3/4" socket head (for 206R motors), SS	4	4	3.75
41875	41875	"O" Ring, #8 SAE (for "N" series motors)	2	2	1.25
BAC-78-8SAE	41441	Reverse check valve, #8 SAE male x 1/2" NPT female (for "N" series motors)	1	1	34.00
BAC-80-8SAE	41455	Adapter, restrictor body, #8 SAE male x 1/2" NPT female (for "N" series motors)	1	1	26.50
41448	41448	"O" Ring, orifice insert	1	1	1.25
BAC-79-5	41457	Orifice, restrictor insert, .078 (for 204R motors)	1	1	13.50
BAC-79-7	41456	Orifice, restrictor insert, .109 (for 206R motors)	1	1	13.50
LS-204N	41417	Flow limiting valve, #8SAE x 1/2" NPT (for 204 motors)	1	1	102.50
LS-206N	41418	Flow limiting valve, #8SAE x 1/2" NPT (for 206 motors)	1	1	102.50

FMC-HYD-202, FMC-HYD-203, FMC-HYD-204, FMC-HYD-206, FMC-HYD-210, and FMC-HYD-310 1-1/4" x 1" Hydraulic Motor Driven Pumps



PART NO.	EDP NO.	DESCRIPTION	REQ.	EACH
RK-FMC	52700	Repair kit for FMC series, includes Viton® mechanical seal 40151, washer 40400, and "O" Ring 40005		69.50
RK-FMCSC	52706	Repair kit for FMC series, includes Silicon Carbide mechanical seal 40152, washer 40400, and "O" Ring 40005		212.75
FMC-HYD-LM	49830	Pump less motor, 200 Series motors		1,173.00
FMC-HYD-310-LM	49855	Pump less motor, 310 motor		1,194.00
BAC-53	41110	Pipe plug, 1/8" NPT	3	0.65
41120	41120	Pipe plug, 1/8" NPT, stainless steel (optional)	3	6.00
BAC-12	40250	Volute, 1 1/4" x 1", cast iron	1	307.50
BAC-23-A	40391	Nut, 3/8" NF Hex, cad plated locknut	1	2.75
BAC-24-HYD-SS	40400	Washer, 3/8", stainless steel	1	1.75
IMPORTANT: BAC-23-B-SS and BAC-24-B-SS must be used together to replace BAC-23-A-SS. See UPDATE 16 for more information.				
BAC-23-B-SS	40393	Nut, 3/8" NF Hex, stainless steel (effective 10/12 for -SS, 150FS, 200SS, and 205 models)	1	1.25
BAC-24-B-SS	42702	Washer, 3/8", stainless steel, vibration proof (effective 10/12 for -SS, 150FS, 200SS, and 205 models)	1	8.25
BAC-26-HYD-CI	40442	Impeller, cast iron, with keyway (optional)	1	251.50
BAC-26-HYD-VALOX	40440	Impeller, Valox, with keyway	1	108.25
40160	40160	"O" Ring for BAC-6 shaft	1	1.25
40169	40169	"O" Ring for BAC-6 shaft, EPDM (optional)	1	1.25
BAC-7V	40151	Seal, Viton® mechanical seal (includes 40160 "O" Ring)	1	58.50
BAC-7B	40110	Seal, Buna N mechanical seal (includes 40160 "O" Ring)(optional)	1	66.00
BAC-7SC	40152	Seal, Silicon carbide mechanical seal (includes 40160 "O" Ring)(optional)	1	201.75
BAC-7SCB	40109	Seal, Silicon carbide mechanical seal, Buna elastomer (includes 40160 "O" Ring)(optional)	1	198.50
BAC-7SCE	40150	Seal, Silicon carbide mechanical seal, EPDM elastomer (includes 40169 "O" Ring)(optional)	1	296.75
BAC-4A	40005	"O" Ring for BAC-12 volute seal, effective Apr. '96	1	9.25
BAC-14-HYD	40300	Mounting frame (for 200N series motors)	1	394.75
BAC-14-HYD-300A	40314	Mounting frame (for BAC-75-HYD-310A hydraulic motor)	1	431.00
40930	40930	Cap screw, 3/8" NC x 3/4" Hex head, stainless steel (optional)	4	2.75
40950	40950	Cap screw, 3/8" NC x 3/4" Hex head	4	0.75
BAC-54	41130	Slinger	1	2.25
BAC-33	40810	Snap ring, internal, BAC-14 mounting frame	2	2.25
BAC-37	40870	Bearing, BAC-6 driven shaft	2	23.25
BAC-32	40790	Snap ring, external, BAC-6 driven shaft	2	0.75
BAC-32-S	40795	Spacer for BAC-6 shaft	1	7.00
BACH-25	40420	Key for impeller, 1/8" x 1/8" x 7/16"	1	1.25
BAC-6-HYD-SS	40061	Shaft, 5/8" Driven shaft with tang slot, stainless steel	1	157.50
BAC-75-HYD-202	41368	2 GPM Hydraulic motor for open-center or closed-center systems with integrated needle valve	1	809.00
BAC-75-HYD-203	41367	3 GPM Hydraulic motor for open-center or closed-center systems with integrated needle valve	1	809.00
BAC-75-HYD-204	41370	4 GPM Hydraulic motor for open-center or closed-center systems with integrated needle valve	1	742.00
BAC-75-HYD-206	41372	7 GPM Hydraulic motor for open or closed-center systems with integrated needle valve	1	742.00
BAC-75-HYD-206-PWM	41324	7 GPM Hydraulic motor for closed-center systems with integrated PWM valve	1	1,953.50
BAC-75-HYD-210	41375	10 GPM Hydraulic motor for open-center or closed-center systems with integrated needle valve	1	785.00
BAC-75-HYD-310	41378	Hydraulic motor, 25 GPM, effective 5/13	1	1,169.75
S200	40161	Seal support spacer for 200 series hydraulic lip seal	1	11.75
S300	40162	Seal support spacer for 300 series hydraulic lip seal	1	11.75
BAC-75-HYD-202N	41332	2 GPM hydraulic motor, "N" series (motor only - no external fittings)	1	789.25
BAC-75-HYD-203N	41333	3 GPM hydraulic motor, "N" series (motor only - no external fittings)	1	789.25
BAC-75-HYD-204N	41433	4 GPM hydraulic motor, "N" series (motor only - no external fittings)	1	723.00
BAC-75-HYD-206N	41397	7 GPM hydraulic motor, "N" series (motor only - no external fittings)	1	723.00
BAC-75-HYD-210N	41434	10 GPM hydraulic motor, "N" series (motor only - no external fittings)	1	764.00
BAC-75-HYD-310N	41344	Hydraulic motor, 25 GPM, effective 5/13 (motor only - less external fittings)	1	1,169.75
41253	41253	Cap screw, 5/16" NC x 3 1/2" socket head (for 204N motor)	4	2.25
41254	41254	Cap screw, 5/16" NC x 4" socket head (for 210N motor)	4	2.25
41255	41255	Cap screw, 5/16" NC x 3 3/4" socket head (for 206N motor)	4	2.25
41330	41330	Cap screw, 5/16" NC x 3/4" hex head (for 310 motor)	4	0.75
41445	41445	"O" Ring, #10 SAE fitting (310N motors)	1	1.25
41875	41875	"O" Ring, #8 SAE (for "N" series motors)	1	1.25
BAC-78-10SAE	41442	Reverse check assembly, #10 SAE x 1/2" NPT (310N motors)	1	36.50
BAC-78-8SAE	41441	Reverse check valve, #8 SAE male x 1/2" NPT female (200N series motors)	1	34.00
BAC-80-8SAE	41455	Adapter, restrictor body, #8 SAE male x 1/2" NPT female (for "N" series motors)	1	26.50
41448	41448	"O" Ring, orifice insert	1	1.25
BAC-79-5	41457	Orifice, restrictor insert, .078 (for 204N motor)	1	13.50
BAC-79-7	41456	Orifice, restrictor insert, .109 (for 206N and 210N motors)	1	13.50
LS-204N	41417	Flow limiting valve for BAC-75-HYD-204N motor, #8 SAE male x 1/2" NPT female (optional)	1	102.50
LS-206N	41418	Flow limiting valve for BAC-75-HYD-206N motor, #8 SAE male x 1/2" NPT female (optional)	1	102.50
LS-210N	41423	Flow limiting valve for BAC-75-HYD-210N motor, #8 SAE male x 1/2" NPT female (optional)	1	102.50

FMC-150-HYD-206, FMC-150F-HYD-206, FMC-150F-HYD-304, FMC-150FS-HYD-206, and FMC-150SP-HYD-206 1-1/2" x 1-1/4" Hydraulic Motor Driven Pumps



PART NO.	EDP NO.	DESCRIPTION	REQ.	EACH
RK-FMC-150	52710	Repair kit for FMC-150, includes Viton® mechanical seal 40151, washer 40400, and "O" Ring		69.50
RK-FMCSC-150	52711	Repair kit for FMC-150, includes Silicon Carbide mechanical seal 40151, washer 40400, and "O" Ring		212.75
FMC-150-HYD-LM	49921	Pump less motor for 200 Series motor		1,213.00
FMC-150F-HYD-LM	49944	Pump less motor for 200 Series motor with NPT and flanged ports		1,282.00
FMC-150FS-HYD-LM	49978	Stainless steel pump less motor for 200 Series motor with NPT and flanged ports		2,437.00
BAC-53	41110	Pipe plug, 1/8" NPT	4	0.65
41120	41120	Pipe plug, 1/8" NPT, stainless steel (optional)	4	6.00
BAC-12-150	40255	Volute, 1 1/2" X 1 1/4", cast iron	1	381.50
BAC-12-150-FLG	40257	Volute, 1 1/2" NPT & 220 full port flange x 1 1/4" NPT & 200 standard port flange (150F models)	1	455.25
BAC-12-150-SP	40254	Volute, 1 1/2" X 1 1/4", self-priming, cast iron (150SP models)	1	952.50
BAC-12-150-SS	40249	Volute, 1 1/2" NPT & 220 full port flange x 1 1/4" NPT & 200 standard port flange, 316 stainless steel (150FS models)	1	1,016.25
BAC-23-A	40391	Nut, 3/8" NF Hex, cad plated locknut	1	2.75
BAC-24-HYD-SS	40400	Washer, 3/8", stainless steel	1	1.75
IMPORTANT: BAC-23-B-SS and BAC-24-B-SS must be used together to replace BAC-23-A-SS. See UPDATE 16 for more information.				
BAC-23-B-SS	40393	Nut, 3/8" NF Hex, stainless steel (effective 10/12 for -SS, 150FS, 200SS, and 205 models)	1	1.25
BAC-24-B-SS	42702	Washer, 3/8", stainless steel, vibration proof (effective 10/12 for -SS, 150FS, 200SS, and 205 models)	1	8.25
BAC-26-150-P	40446	Impeller, with keyway, thermoplastic	1	108.25
BAC-26-150-CI	40445	Impeller, cast iron, with keyway (optional)	1	266.75
BAC-26-150-PI	40448	Impeller, with keyway, polypropylene (optional)	1	113.50
BAC-26-150-SS	40449	Impeller, with keyway, stainless steel (optional)	1	426.75
40160	40160	"O" Ring for BAC-6 shaft	1	1.25
40169	40169	"O" Ring for BAC-6 shaft, EPDM (optional)	1	1.25
BAC-7V	40151	Seal, Viton® mechanical seal (includes 40160 "O" Ring)	1	58.50
BAC-7B	40110	Seal, Buna N mechanical seal (includes 40160 "O" Ring)(optional)	1	66.00
BAC-7SC	40152	Seal, Silicon carbide mechanical seal (includes 40160 "O" Ring)(optional)	1	201.75
BAC-7SCB	40109	Seal, Silicon carbide mechanical seal, Buna elastomer (includes 40160 "O" Ring)(optional)	1	198.50
BAC-7SCS	40150	Seal, Silicon carbide mechanical seal, EPDM elastomer (includes 40169 "O" Ring)(optional)	1	296.75
BAC-4-150	40015	"O" Ring, Volute seal	1	9.25
BAC-4-150-E	40016	"O" Ring, Volute seal, EPDM (optional)	1	10.75
BAC-14-150-HYD	40305	Mounting frame (for BAC-75-HYD-206 hydraulic motor)	1	475.00
BAC-14-150-HYD-300A	40328	Mounting frame (for 300A series motors)	1	517.25
BAC-14-150-HYD-SS	40319	Mounting frame, 316 stainless steel (for 150FS models)	1	1,067.00
40930	40930	Cap screw, 3/8" NC x 3/4" Hex head, stainless steel (optional)	4	2.75
40950	40950	Cap screw, 3/8" NC x 3/4" Hex head	4	0.75
BAC-54	41130	Slinger	1	2.25
BAC-33	40810	Snap ring, internal, BAC-14 mounting frame	2	2.25
BAC-37	40870	Bearing, BAC-6 driven shaft	2	23.25
BAC-32	40790	Snap ring, external, BAC-6 driven shaft	2	0.75
BAC-32-S	40795	Spacer for BAC-6 shaft	1	7.00
BACH-25	40420	Key for impeller, 1/8" x 1/8" x 7/16"	1	1.25
BAC-6-HYD-SS	40061	Shaft, 5/8" Driven shaft with tang slot, stainless steel	1	157.50
BAC-75-HYD-206	41372	7 GPM Hydraulic motor for open or closed-center systems with integrated needle valve	1	742.00
BAC-75-HYD-206-PWM	41324	7 GPM Hydraulic motor for closed-center systems with integrated PWM valve	1	1,953.50
BAC-75-HYD-304	41381	Hydraulic motor, 11 GPM, effective 5/13	1	1,114.50
BAC-75-HYD-304-PWM	41348	Hydraulic motor, 11 GPM, with integrated PWM valve	1	2,289.50
S200	40161	Seal support spacer for 200 series hydraulic lip seal	1	11.75
S300	40162	Seal support spacer for 300 series hydraulic lip seal	1	11.75
BAC-75-HYD-206N	41397	7 GPM hydraulic motor, "N" series (motor only - no external fittings)	1	723.00
BAC-75-HYD-304N	41343	Hydraulic motor, 11 GPM, effective 5/13 (motor only - less external fittings)	1	1,100.25
41255	41255	Cap screw, 5/16" N.C. x 3 3/4" Socket head (for 206N motor)	4	2.25
41330	41330	Cap screw, 5/16" NC x 3/4" (for 300A series motors)	4	0.75
41445	41445	"O" Ring, #10 SAE fitting (304N motors)	1	1.25
41875	41875	"O" Ring, #8 SAE fitting	2	1.25
BAC-78-8SAE	41441	Reverse check assembly, #8 SAE male x 1/2" NPT female (206N motors)	1	34.00
BAC-78-10SAE	41442	Reverse check assembly, #10 SAE x 1/2" NPT (304N motors)	1	36.50
BAC-78-10X10SAE	41467	Reverse check assembly, #10 SAE x #10 SAE (304-PWM motors)	1	41.75
BAC-80-8SAE	41455	Body, restrictor orifice, #8 SAE male x 1/2" NPT female (206N motors)	1	26.50
41448	41448	"O" Ring for restrictor insert BAC-79-7 (206N motors)	1	1.25
BAC-79-7	41456	Orifice, restrictor insert, .109 in., use with BAC-80-8SAE (206N motors)	1	13.50
BAC-79-8	41447	Orifice, restrictor insert, 0.125 (304N motor)	1	13.50
LS-206N	41418	Flow limiting valve for BAC-75-HYD-206N motor, #8 SAE male x 1/2" NPT female (optional)	1	102.50
LS-304N	41429	Flow limiter (optional)	1	102.50

FMC-200-HYD-210, FMC-200-HYD-304, FMC-200SS-HYD-304, FMC-200F-HYD-304, and FMC-200-HYD-310 2" x 1-1/2" Hydraulic Motor Driven Pumps



PART NO.	EDP NO.	DESCRIPTION	REQ.	EACH
RK-FMC	52700	Repair kit for FMC series, includes Viton® mechanical seal 40151, washer 40400, and "O" Ring 40005		69.50
RK-FMCSC	52706	Repair kit for FMC series, includes Silicon Carbide mechanical seal 40152, washer 40400, and "O" Ring 40005		212.75
FMC-200-HYD-LM	49842	Pump less motor for 210 model		1,298.00
FMC-200-HYD-300-LM	49865	Pump less motor for 300 Series motors		1,319.00
BAC-53	41110	Pipe plug, 1/8" NPT	3	0.65
41120	41120	Pipe plug, 1/8" NPT, stainless steel (optional)	3	6.00
7AC-14-CCW	41526	Volute, 2" NPT x 1-1/2" NPT, cast iron	1	418.75
7AC-14-FLG	41530	Volute, 300 standard flange x 220 full port flange, cast iron	1	523.75
7AC-14-CCW-SS	41531	Volute, 2" NPT x 1-1/2" NPT, stainless steel	1	879.75
BAC-23-A	40391	Nut, 3/8" NF Hex, cad plated locknut	1	2.75
BAC-24-HYD-SS	40400	Washer, 3/8", stainless steel	1	1.75
IMPORTANT: BAC-23-B-SS and BAC-24-B-SS must be used together to replace BAC-23-A-SS. See UPDATE 16 for more information.				
BAC-23-B-SS	40393	Nut, 3/8" NF Hex, stainless steel (effective 10/12 for -SS, 150FS, 200SS, and 205 models)	1	1.25
BAC-24-B-SS	42702	Washer, 3/8", stainless steel, vibration proof (effective 10/12 for -SS, 150FS, 200SS, and 205 models)	1	8.25
BAC-26-200-P	40434	Impeller, 5 1/2" dia., with extended keyway, thermoplastic, (effective 12/99)	1	156.50
BAC-26-200-CI	40433	Impeller, 5 1/2" dia., with extended keyway, cast iron (effective 10/98) (optional)	1	326.25
BAC-26-200-SS	40436	Impeller, 5 1/2" dia., with extended keyway, stainless steel (optional)	1	445.50
BAC-4A	40005	"O" Ring for BAC-12 volute seal, effective Apr. '96	1	9.25
40160	40160	"O" Ring for BAC-6 shaft	1	1.25
40169	40169	"O" Ring for BAC-6 shaft, EPDM (optional)	1	1.25
BAC-7V	40151	Seal, Viton® mechanical seal (includes 40160 "O" Ring)	1	58.50
BAC-7B	40110	Seal, Buna N mechanical seal (includes 40160 "O" Ring)(optional)	1	66.00
BAC-7SC	40152	Seal, Silicon carbide mechanical seal (includes 40160 "O" Ring)(optional)	1	201.75
BAC-7SCB	40109	Seal, Silicon carbide mechanical seal, Buna elastomer (includes 40160 "O" Ring)(optional)	1	198.50
BAC-7SCE	40150	Seal, Silicon carbide mechanical seal, EPDM elastomer (includes 40169 "O" Ring)(optional)	1	296.75
BAC-14-HYD	40300	Mounting frame (for -210 hydraulic motor)	1	394.75
BAC-14-HYD-300A	40314	Mounting frame, 300A series motor	1	431.00
BAC-14-HYD-300A-LIN	40337	Mounting frame, 300A series motor, stainless steel	1	505.00
BAC-14-LIN	40336	Liner, stainless steel, for mounting frame	1	170.75
40950	40950	Cap screw, 3/8" NC x 3/4" Hex head	4	0.75
40930	40930	Cap screw, 3/8" NC x 3/4" Hex head, stainless steel (optional)	4	2.75
41254	41254	Cap screw, 5/16" NC x 4", socket head (for 210N motor)	4	2.25
41330	41330	Cap screw, 5/16" NC x 3/4" (for 304 and 310 motors)	8	0.75
BAC-54	41130	Slinger	1	2.25
BAC-33	40810	Snap ring, internal, BAC-14 mounting frame	2	2.25
BAC-37	40870	Bearing, BAC-6 driven shaft	2	23.25
BAC-32	40790	Snap ring, external, BAC-6 driven shaft	2	0.75
BAC-32-S	40795	Spacer for BAC-6 shaft	1	7.00
BAC-25	40425	Key for impeller with extended keyway, 1/8" x 1/8" x 13/16" (effective 10/98)	1	1.25
BAC-6-HYD-200-SS	40063	Shaft, 5/8" Driven shaft with tang slot and extended keyway, stainless steel (effective 10/98)	1	157.50
BAC-75-HYD-210	41375	10 GPM Hydraulic motor for open-center or closed-center systems with integrated needle valve	1	785.00
BAC-75-HYD-304	41381	Hydraulic motor, 11 GPM, effective 5/13	1	1,114.50
BAC-75-HYD-304A-12SAE	41426	Hydraulic motor, A series, 13 GPM, #12 SAE ports	1	1,114.50
BAC-75-HYD-310	41378	Hydraulic motor, 25 GPM, effective 5/13	1	1,169.75
S200	40161	Seal support spacer for 200 series hydraulic lip seal	1	11.75
S300	40162	Seal support spacer for 300 series hydraulic lip seal	1	11.75
BAC-75-HYD-210N	41434	10 GPM hydraulic motor, "N" series (motor only - no external fittings)	1	764.00
BAC-75-HYD-304N	41343	Hydraulic motor, 11 GPM, effective 5/13 (motor only - less external fittings)	1	1,100.25
BAC-75-HYD-310N	41344	Hydraulic motor, 25 GPM, effective 5/13 (motor only - less external fittings)	1	1,169.75
41875	41875	"O" Ring, #8 SAE (for "N" series motors)	1	1.25
41445	41445	"O" Ring, #10 SAE fitting (304N and 310N motors)	1	1.25
BAC-78-8SAE	41441	Reverse check valve, #8 SAE male x 1/2" NPT female (210N motors)	1	34.00
BAC-78-10SAE	41442	Reverse check assembly, #10 SAE x 1/2" NPT (304N and 310N motors)	1	36.50
41448	41448	"O" Ring, orifice insert	1	1.25
BAC-79-7	41456	Orifice, restrictor insert, .109 (210N motors)	1	13.50
BAC-79-8	41447	Orifice insert, restrictor insert, 0.125 (304N motors)	1	13.50
BAC-80-8SAE	41455	Adapter, restrictor body, #8 SAE male x 1/2" NPT female (for "N" series motors)	1	26.50
LS-210N	41423	Flow limiting valve for BAC-75-HYD-210N motor, #8 SAE male x 1/2" NPT female (optional)	1	102.50
LS-304N	41429	Flow limiter valve for BAC-75-HYD-304N, #8 SAE male x 1/2" NPT female (optional)	1	102.50

FMCS-125-HYD, FMCWS-125-HYD, FMCS-155F-HYD, and FMCWS-155F-HYD PRO5 Series Pumps

PART NO.	EDP NO.	DESCRIPTION	SC125	WS125	SC155	WS155	EACH
RK-FMCS-PRO5	52717	Repair kit, includes 40015 and 40149	1		1		220.25
RK-FMCWS-PRO5	52728	Repair kit, includes 40015 (2 each), 40139 and 55032		1		1	300.50
BAC-53	41110	Pipe plug	4	4	4	4	0.65
41120	41120	Pipe plug, stainless steel (optional)	4	4	4	4	6.00
BAC-12-125	30147	Volute , 1-1/4" NPT X 1" NPT	1	1			376.00
BAC-12-150-FLG-EC	40266	Volute , cast iron, NPT and flanged, E-coated			1	1	514.75
BAC-12-150-SS	40249	Volute, 316 stainless steel , NPT & flanged				1	1,016.25
BAC-23-B-SS	40393	Nut, 3/8" NF, stainless steel	1	1	1	1	1.25
BAC-24-B-SS	42702	Washer, 3/8", stainless steel, vibration proof	1	1	1	1	8.25
BAC-26-125-P	40444	Impeller, thermoplastic, keyway	1	1			128.00
BAC-26-150-P	40446	Impeller, Valox, keyway			1	1	108.25
BAC-26-150-CI	40445	Impeller, cast iron, keyway (optional)			1	1	266.75
BAC-26-150-PI	40448	Impeller, polypropylene, keyway (optional)			1	1	113.50
BAC-26-150-SS	40449	Impeller, with keyway, stainless steel (optional)			1	1	426.75
72762	72762	Bolt, 5/16"-18 x 1-1/4", socket head, SS		4		4	2.75
BAC-16	45285	Seal plate, machining		1		1	512.75
55851	55851	Sight gauge, #8 SAE		1		1	55.00
41107	41107	Bushing, #8 SAE x 1/4" FNPT, with o-ring		1		2	14.25
41316	41316	Air valve, 1/4" NPT		1		1	17.25
BAC-4-150	40015	O-ring, body seal	1	2	1	2	9.25
BAC-7-WS	40139	Double seal, 5/8" shaft		1		1	220.50
BAC-7SC-205V	40149	Seal, silicon carbide/Viton	1		1		201.75
BAC-14-5-HYD	40288	Mounting frame (for 200 and 300 Series hydraulic motor)	1	1	1	1	434.50
BAC-42	40970	Cap screw, 5/16"-16 x 2", hex head		4		4	1.75
40950	40950	Cap screw, 3/8"NC x 3/4" hex head	4		4		0.75
40930	40930	Cap screw, 3/8" NC x 3/4" hex head, stainless steel	4		4		2.75
50150	50150	Pressure gauge, 0-60 PSI, 1/8" NPT		1		1	29.75
44039	44039	Bushing, #8 SAE x 1/8" FNPT, with o-ring		1			35.25
41108	41108	Plug, #8 SAE, hex head		1		1	10.25
BAC-54	41130	Slinger	1	1	4	1	2.25
BACH-32-HD	40835	Snap ring, external, shaft	3	3	3	3	3.75
BACH-33	40820	Snap ring, internal, mounting frame	2	2	2	2	1.75
40880	40880	Ball bearing, sealed	2	2	2	2	28.50
BACH-25	40420	Key, 1/8" x 1/8" x 1/2"	1	1	1	1	1.25
BAC-6-125-HYD-SS	41582	Shaft, .625 driven with tank slot, stainless steel	1		1		169.75
BAC-6-125-HYD-SS-WS	41581	Shaft, .625 DIA, 125-150, SS, WS		1		1	233.75
S255	40177	Seal support spacer for 200 Series HYD motor	1	1	1	1	15.00
S300	40162	Seal support spacer			1	1	11.75
BAC-75-HYD-204-PRO5	41322	Hydraulic motor, 4 GPM	1	1			816.00
BAC-75-HYD-206-PRO5	41329	Hydraulic motor, 7 GPM (motor only - no external fittings)	1		1	1	816.00
BAC-75-HYD-206-PRO5-PWM	41290	Hydraulic motor, integrated PWM valve, 7 GPM	1		1	1	1,953.50
BAC-75-HYD-304	41381	Hydraulic motor, 11 GPM			1	1	1,114.50
BAC-75-HYD-304-PWM	41348	Hydraulic motor, 11 GPM, with integrated PWM valve			1	1	2,289.50
41252	41252	Cap screw, 5/16" NC x 3-1/2" socket head, ss		4			3.75
41253	41253	Cap screw, 5/16"NC x 3-1/2" socket head, SS (for 204N motor)	2				2.25
41255	41255	Cap screw, 5/16" N. C. x 3-3/4" socket head (for 206N motor)	2				2.25
41259	41259	Cap screw, 5/16"NC x 3-3/4" socket head, SS (for 206N motor)			2	2	3.75
41261	41261	Cap screw, 5/16"NC x 6" socket head, SS (for 206-PWM motor)	2		2	2	3.75
41330	41330	Cap screw, 5/16" NC x 3/4" (for 304-PWM motor)			2	4	0.75
41875	41875	O-ring, #8 SAE fitting	2	2	2	2	1.25
BAC-78-8SAE	41441	Reverse check valve, #8 SAE male x 1/2" NPT female	1	1	1	1	34.00
BAC-78-10SAE	41442	Reverse check assembly, #10 SAE x 1/2" NPT					36.50
BAC-78-10X8SAE	41462	Reverse check assembly, #8 SAE x #10 SAE, w/ O-ring			1	1	39.75
BAC-78-10X10SAE	41467	Reverse check assembly, #10 SAE x #10 SAE (304-PWM motors)			1	1	41.75
BAC-80-8SAE	41455	Adapter, restrictor body, #8 SAE male x 1/2" NPT female	1	1	1	1	26.50
41445	41445	O-ring, #10 SAE			1	1	1.25
41448	41448	O-ring, orifice insert	1	1	1	1	1.25
BAC-79-5	41457	Orifice insert, restrictor 1/2" x #8 SAE, w/ O-ring	1	1			13.50
BAC-79-7	41456	Orifice, restrictor insert, .109 (206N)	1		1	1	13.50
BAC-79-8	41447	Orifice insert, restrictor, w/ O-ring (304N) (Do not use with 304-PWM)			1	1	13.50
LS-204N	41417	Flow limiting valve (204N), #8 SAE male x 1/2" NPT female, w/ O-ring	1	1			102.50
LS-206N	41418	Flow limiting valve (206N), #8 SAE male x 1/2" NPT female, optional	1		1	1	102.50
LS-304N	41429	Flow limiting valve, #8 MSAE x 1/2" FNPT (304N) (optional)			1	1	102.50
55032	55032	Barrier fluid, quart		1		1	61.50

FMCS-155FS-HYD-206

1-1/2" x 1-1/4" Hydraulic Motor Driven Pumps



PART NO.	EDP NO.	DESCRIPTION	REQ.	EACH
RK-FMCS-155	52713	Repair kit for FMCS-155, includes 2106 mechanical seal 40149, and "O" Ring 40015		212.75
41120	41120	Pipe plug, stainless steel	4	6.00
BAC-12-150-SS	40249	Volute, 316 stainless steel, NPT & flanged	1	1,016.25
BAC-23-B-SS	40393	Nut, 3/8" NF, stainless steel	1	1.25
BAC-24-B-SS	42702	Washer, 3/8", stainless steel, vibration proof	1	8.25
BAC-26-150-P	40446	Impeller, Valox, keyway	1	108.25
BAC-26-150-CI	40445	Impeller, cast iron, keyway (optional)	1	266.75
BAC-26-150-PI	40448	Impeller, polypropylene, keyway (optional)	1	113.50
BAC-26-150-SS	40449	Impeller, with keyway, stainless steel (optional)	1	426.75
BAC-4-150	40015	O-ring, body seal	1	9.25
BAC-7SC-205V	40149	Seal, silicon carbide/Viton	1	201.75
BAC-14-155-HYD-SS	40348	Mounting frame, 316 stainless steel	1	1,067.00
40930	40930	Cap screw, 3/8" NC x 3/4" hex head, stainless steel	4	2.75
BAC-54	41130	Slinger	1	2.25
BACH-32-HD	40835	Snap ring, external, shaft	3	3.75
BACH-33	40820	Snap ring, internal, mounting frame	2	1.75
40880	40880	Ball bearing, sealed	2	28.50
BACH-25	40420	Key, 1/8" x 1/8" x 1/2"	1	1.25
BAC-6-155-HYD-SS	40072	Shaft, 5/8" diameter, keyway and tang slot, stainless steel	1	263.50
S255	40177	Seal support spacer for 200 Series HYD motor	1	15.00
S305	40163	Seal support spacer for 155FS series pump (for 304-PWM motor)	1	18.75
BAC-75-HYD-206-PRO5	41329	Hydraulic motor, 7 GPM (motor only - no external fittings)	1	816.00
BAC-75-HYD-304-PWM	41348	Hydraulic motor, 11 GPM, with integrated PWM valve	1	2,289.50
41255	41255	Cap screw, 5/16" N. C. x 3-3/4" socket head (for 206N motor)	4	2.25
41330	41330	Cap screw, 5/16" NC x 3/4" (for 304-PWM motor)	4	0.75
41875	41875	O-ring, #8 SAE fitting	2	1.25
BAC-78-8SAE	41441	Reverse check valve, #8 SAE male x 1/2" NPT female	1	34.00
BAC-78-10X10SAE	41467	Reverse check assembly, #10 SAE x #10 SAE (304-PWM motors)	1	41.75
BAC-80-8SAE	41455	Adapter, restrictor body, #8 SAE male x 1/2" NPT female	1	26.50
41448	41448	O-ring, orifice insert	1	1.25
BAC-79-7	41456	Orifice, restrictor insert, .109 (206N)	1	13.50
LS-206N	41418	Flow limiting valve (206N), #8 SAE male x 1/2" NPT female, optional	1	102.50

ALMOST AS
DEPENDABLE
 AS AN ACE PUMP.



If dependability is something you value in life, look no further than Ace brand pumps. Every Ace pump features state-of-the-art design, advanced components and uncompromising quality control. The end result: pumps you can count on for years of reliable service. To learn why an Ace pump is a farmer's best friend, please visit us at www.acepumps.com, or contact your nearest Ace Pumps distributor.



FMCSC-205F-HYD-304 and FMCSC-205FS-HYD-304 2" x 1-1/2" Hydraulic Motor Driven Pumps



PART NO.	EDP NO.	DESCRIPTION	REQ.	EACH
RK-FMCSC-205	52705	Repair kit for 205F series, includes 2106 mechanical seal 40149, and "O" Ring 40005		212.75
BAC-53	41110	Pipe plug, 1/8" NPT	3	0.65
41120	41120	Pipe plug, 1/8" NPT, stainless steel (optional)	3	6.00
7AC-14-FLG	41530	Volute, 300 standard flange x 220 full port flange, cast iron	1	523.75
7AC-14-FLG-SS	41532	Volute, 300 standard flange x 220 full port flange, stainless steel (standard on FS model)	1	1,021.75
BAC-23-B-SS	40393	Nut, 3/8" NF Hex, stainless steel (effective 10/12 for -SS, 150FS, 200SS, and 205 models)	1	1.25
BAC-24-B-SS	42702	Washer, 3/8", stainless steel, vibration proof (effective 10/12 for -SS, 150FS, 200SS, and 205 models)	1	8.25
BAC-26-200-P	40434	Impeller, 5 1/2" dia., with extended keyway, thermoplastic	1	156.50
BAC-26-200-CI	40433	Impeller, 5 1/2" dia., with extended keyway, cast iron (optional)	1	326.25
BAC-26-200-SS	40436	Impeller, 5 1/2" dia., with extended keyway, stainless steel (standard on FS model)(optional)	1	445.50
BAC-4A	40005	"O" Ring for volute seal	1	9.25
BAC-75C-205V	40149	Seal, Type 2106 silicon carbide mechanical seal (includes 40160 "O" Ring)	1	201.75
BAC-14-205-HYD	40338	Mounting frame, 205F series pump (for 300A series hydraulic motors)	1	448.75
BAC-14-205-HYD-SS	40346	Mounting frame, 205F series pump, stainless steel (standard on FS model)	1	1,079.25
40950	40950	Cap screw, 3/8" NC x 3/4" Hex head	4	0.75
40930	40930	Cap screw, 3/8" NC x 3/4" Hex head, stainless steel (optional)	4	2.75
41330	41330	Cap screw, 5/16" NC x 3/4"	4	0.75
BAC-54	41130	Slinger	1	2.25
BACH-33	40820	Snap ring, internal, BAC-14-205 mounting frame	2	1.75
BACH-32-HD	40835	Snap ring, external, BAC-6-205 driven shaft	3	3.75
40880	40880	Bearing, BAC-6-205 driven shaft	2	28.50
BAC-6-205-HYD-SS	40068	Shaft, 5/8" Driven shaft with tang slot and extended keyway, stainless steel	1	239.25
BAC-25	40425	Key for impeller with extended keyway, 1/8" x 1/8" x 13/16"	1	1.25
BAC-75-HYD-304	41381	Hydraulic motor, 13 GPM, effective 5/13	1	1,114.50
BAC-75-HYD-304-PWM	41348	Hydraulic motor, 13 GPM, with integrated PWM valve	1	2,289.50
S305	40163	Seal support spacer for 205F series pump	1	18.75
BAC-75-HYD-304N	41343	Hydraulic motor, 13 GPM, effective 5/13 (motor only - less external fittings)	1	1,100.25
BAC-75-HYD-304A-12SAE	41426	Hydraulic motor, A series, 13 GPM, #12 SAE ports	1	1,114.50
41875	41875	"O" Ring, #8 SAE fitting	1	1.25
41445	41445	"O" Ring, #10 SAE fitting	1	1.25
BAC-80-8SAE	41455	Body, restrictor orifice, #8SAE x 1/2" NPT	1	26.50
41448	41448	"O" Ring, orifice insert	1	1.25
BAC-79-8	41447	Orifice insert, restrictor insert, 0.125	1	13.50
BAC-78-10SAE	41442	Reverse check assembly, #10 SAE x 1/2" NPT	1	36.50
BAC-78-10X10SAE	41467	Reverse check assembly, #10 SAE x #10 SAE (304-PWM motors)	1	41.75
LS-304N	41429	Flow limiter (optional)	1	102.50

DPK Gemini Dual Pump Kit



PART NO.	EDP NO.	DESCRIPTION	REQ.	EACH
RK-DPK	74050	Repair kit for Gemini DPK, includes "O" rings and seals to reseal kit		134.25
DPK-1	74005	Manifold assembly	1	2,315.00
DPK-2	74015	Switch box assembly with 15' cable	1	441.00
DPK-3	74020	Implement cable 12'	1	121.25
DPK-EXT	74010	Extension cable 22' (optional)	1	121.25
44044	44044	Tee for return hoses	1	29.00
44092	44092	Adapter for load sensing connection	1	2.75
74045	74045	Cable with 8" connector for PWM control	2	10.75
DPK-18-MAN-7	74025	Manual flow control valve	2	573.25
DPK-18-PRO-7	74040	Proportional valve with coil	2	606.25
74030	74030	Coil for proportional valve	2	167.50
74035	74035	Nut, solenoid	1	3.75
44096	44096	Adapter for manifold outlet hoses	2	4.75
41875	41875	"O" ring for manifold outlet adapter	2	1.25
44098	44098	Adapter for manifold inlet	1	6.00
41445	41445	"O" ring for manifold inlet adapter	1	1.25
41104	41104	Plug for load sensing port	1	2.75

FMC-650-HYD, FMC-650F-HYD, FMC-650FS-HYD, FMCWS-650F-HYD, and FMCWS-650FS-HYD 1-1/2" x 1-1/4" Hydraulic Motor Driven Pumps



PART NO.	EDP NO.	DESCRIPTION	REQ.	EACH
RK-FMC-650	52720	Repair kit, includes "O" ring 40015, washer 30029, and carbon/ceramic/Viton® seal 40145		123.75
RK-FMCSC-650	52721	Repair kit, includes "O" ring 40015, washer 30029, and silicon carbide/Viton® seal 40146		248.50
RK-FMCWS-650	52722	Repair kit, includes "O" ring 40015 (2 each), washer 30029, dual seal 40143, and barrier fluid 55032 (1 quart)		308.25
FMC-650-HYD-LM	49968	Pump less motor, M series motor		1,652.00
FMC-650F-HYD-LM	49776	Pump less motor, flanged connections, M series motor		1,811.00
BAC-53	41110	Pipe plug, 1/8" NPT, square head	3	0.65
41120	41120	Pipe plug, 1/8" NPT, hex head, stainless steel (optional)	3	6.00
BAC-12-650	30163	Volute, 1-1/2" NPT x 1-1/4" NPT, cast iron, e-coated	1	469.50
BAC-12-650-FLG	30159	Volute, 1-1/2" NPT and 220 full port flange x 1-1/4" NPT and 200 standard port flange, cast iron, e-coated	1	567.75
BAC-12-650-FLG-SS	30156	Volute, 1-1/2" NPT and 220 full port flange x 1-1/4" NPT and 200 standard port flange, 316 stainless steel (650FS models)	1	1,079.25
BAC-4-150	40015	"O" Ring, volute seal (2 for wetseal)	1	9.25
40930	40930	Cap screw, 3/8" NC x 3/4" hex head, stainless steel, impeller attachment	1	2.75
30029	30029	Washer, 3/8" I.D., sealing, stainless steel	1	2.25
BAC-26-650	30169	Impeller, cast iron, e-coated	1	317.50
BAC-26-650-SS	30191	Impeller, stainless steel (optional)	1	555.50
BAC-26-650-WS	30192	Impeller, cast iron, wetseal, e-coated	1	372.50
BAC-26-650-WS-SS	30193	Impeller, stainless steel, wetseal (optional)	1	600.75
BAC-16-650-A	45282	Seal plate, cast iron, e-coated, wetseal	1	518.25
BAC-16-650-A-SS	45283	Seal plate, stainless steel, wetseal (optional)	1	854.25
BAC-16-650-LIN	40344	Liner, 316 stainless steel (use with BAC-14-650-HYD-LIN frame)	1	433.25
41107	41107	Plug, #8 SAE x 1/4" FNPT, hex, with o-ring, wetseal	1	14.25
41316	41316	Air valve, 1/4" NPT, wetseal	1	17.25
BAC-7-650	40145	Seal, carbon/ceramic/Viton®, Type 2106 3/4"	1	112.25
BAC-7SC-650	40146	Seal, silicon carbide/Viton®, Type 2106 3/4" (optional)	1	237.00
BAC-7-650-WS	40143	Dual seal assembly, Type 21, .750 shaft, wetseal	1	226.00
41108	41108	Plug, #8 SAE, hex head, with o-ring, wetseal	1	10.25
44038	44038	Bushing, 1/2" MNPT x 1/8" FNPT, wetseal (prior to 11/11)	1	6.75
44039	44039	Bushing, #8 SAE x 1/8" FNPT, wetseal	1	35.25
50150	50150	Pressure gauge, 0-60 PSI, 1/8" NPT, wetseal	1	29.75
55851	55851	Site gauge, steel, #8 SAE, with float, wetseal	1	55.00
BAC-14-650-HYD	40325	Mounting frame, cast iron, e-coated	1	739.75
BAC-14-650-HYD-LIN	40343	Mounting frame, machined for stainless steel liner, cast iron, e-coated (FMC-650FS models)	1	798.25
40950	40950	Cap screw, 3/8" NC x 3/4" hex head (volute)	8	0.75
40930	40930	Cap screw, 3/8" NC x 3/4" hex head, stainless steel (volute optional)	8	2.75
BAC-42	40970	Cap screw, 3/8" NC x 2" hex head, wetseal (volute)	4	1.75
41907	41907	Cap screw, 3/8" NC x 1", socket head, stainless steel (4 for wetseal seal plate and 2 for motor mount)	6	3.75
BAC-54-650	41132	Slinger, 1.5" OD x 7/8" ID	1	6.00
41943	41943	Snap ring, internal, mounting frame	2	4.75
ACAL-32	30174	Snap ring, external, wetseal	3	2.25
40875	40875	Bearing, FMC-650 models	2	51.75
41085	41085	Key, .188 x .188 x .875, FMC-650 models	1	1.50
BAC-6-650-HYD-SS	40051	Shaft, 1.13" diameter, 11 tooth female spline, stainless steel	1	400.25
BAC-6-650-HYD-SS-WS	40049	Shaft, 11T female spline, stainless steel, wetseal	1	460.75
BAC-32-650-WS	40802	Spacer, shaft, wetseal	1	48.50
BAC-75-HYD-M16	41359	Motor, hydraulic, pressure plated gear type, 14.5 GPM	1	1,175.25
BAC-75-HYD-M16-CD	41358	Motor, hydraulic, pressure plated gear type, case drain, 14.5 GPM	1	1,152.00
BAC-75-HYD-M16-PWM	41327	Hydraulic motor, pressure plated gear type, 14 GPM, PWM	1	2,649.25
42701	42701	Washer, 3/8", SS	2	0.75
41445	41445	"O" Ring, #10 SAE fitting	2	1.25
BAC-78-10SAE	41442	Reverse check, #10 SAE male x 1/2" NPT female	1	36.50
BAC-80-10SAE	41446	Body, adapter/restrictor, #10 SAE male x 1/2" NPT female	1	26.50
41448	41448	"O" Ring, restrictor insert	1	1.25
BAC-79-8	41447	Insert, restrictor orifice, .125 (for M16 motor)	1	13.50
55032	55032	Barrier fluid, quart (32 oz.)		61.50

OASIS-RES

Oasis WetSeal Pump Reservoir

PART NO.	EDP NO.	DESCRIPTION	REQ.	EACH
41108	41108	Plug, #8 SAE	2	10.25
41316	41316	Air Valve, 1/4" NPT	1	17.25
45271	45271	Tubing	1	47.25
45272	45272	"O" Ring, end cap	2	1.25
45273	45273	Regulator, 0 - 30 PSI	1	90.50
45274	45274	Nipple, 1/4" NPT	1	6.00
45276	45276	Adapter, swivel, #8 SAE x 1/4" NPT	3	17.75
45277	45277	Cap screw, 1/4" x 6.5"	3	3.75
45278	45278	Hose barb, push lock, 1/4"	6	10.75
50150	50150	Gauge, 0 - 60 PSI, 1.5" diameter, 1/8" back mount	1	29.75
55032	55032	Barrier fluid, quart	1	61.50
60500	60500	Nut, 1/4"	3	0.60
BAC-16-RES	45269	Reservoir, end cap	2	392.25

FMC-750F-HYD and FMC-755FS-HYD 300 Flange x 220 Flange Hydraulic Motor Driven Pumps



PART NO.	EDP NO.	DESCRIPTION	REQ.	EACH
RK-FMC-750	52724	Repair kit, includes 2 "O" rings 40019, shaft seal 40147, and 2 qts barrier fluid 55032		411.75
FMC-750F-HYD-LM	50025	Pump less motor, M series motor		3,130.00
BAC-53	41110	Pipe plug, 1/8" NPT (volute)	4	0.65
41120	41120	Pipe plug, 1/8" NPT, stainless steel	4	6.00
BAC-12-750-FLG	30158	Volute, 300 X 220 flange, cast iron, e-coated	1	737.50
BAC-12-750-SS	30152	Volute, 300 X 220 flange, cast iron, stainless steel	1	1,200.50
ACAL-4	30009	"O" Ring, volute seal	2	14.25
40397	40397	Acorn nut, 5/8-11 stainless steel	1	17.50
BAC-26-750-CI	30182	Impeller, cast iron, e-coated	1	565.50
BAC-26-750-SS	30189	Impeller, stainless steel (optional)	1	630.50
BAC-16-750	45264	Seal plate, cast iron, e-coated	1	551.25
BAC-16-750-SS	45259	Seal plate, cast iron, stainless steel	1	909.50
41108	41108	Plug, SAE #8, hex head, with "O" Ring	2	10.25
BAC-7-750V	40147	Dual seal assembly, Type 21, .875 shaft, carbon/ceramic/Viton®	1	260.25
BAC-14-750-HYD	40333	Mounting frame, cast iron, e-coated	1	923.75
40952	40952	3/8-16 x 2.75 cap screw (volute)	4	2.25
41907	41907	Cap screw, socket head, stainless steel (seal plate and motor mount)	6	3.75
50150	50150	Pressure gauge, 0 - 60 PSI, 1/8" NPT	1	29.75
44039	44039	Bushing, #8 SAE x 1/8" FNPT	1	35.25
41107	41107	Plug, #8 SAE x 1/4" FNTP, hex, with o-ring	1	14.25
41316	41316	Air valve, 1/4" NPT	1	17.25
55851	55851	Site gauge, steel, #8 SAE, with float	1	55.00
45267	45267	Seal plate spacer	4	33.00
BAC-54-650	41132	Slinger, 7/8" shaft	1	6.00
41943	41943	Snap ring, internal, frame	2	4.75
ACAL-32	30174	Snap ring, external, shaft	2	2.25
40875	40875	Ball bearing, sealed	2	51.75
41085	41085	Key, .188 x .188 x .750	1	1.50
BAC-6-750-HYD-SS-WS	40066	Shaft, 11T female spline, stainless steel	1	545.75
BAC-32-750	40793	Shaft spacer	1	56.25
BAC-75-HYD-M22	41355	Hydraulic motor, pressure plated gear type, 18 GPM	1	1,193.00
BAC-75-HYD-M25	41356	Hydraulic motor, pressure plated gear type, 20 GPM	1	1,216.00
BAC-75-HYD-M22-CD	41353	Hydraulic motor, pressure plated gear type, case drain, 18 GPM	1	1,203.75
BAC-75-HYD-M25-CD	41352	Hydraulic motor, pressure plated gear type, case drain, 20 GPM	1	1,227.00
BAC-75-HYD-M22-PWM	41336	Hydraulic motor, pressure plated gear type, 18 GPM, PWM	1	3,063.50
42701	42701	Washer, motor mount, stainless steel	2	0.75
41445	41445	"O" Ring, #10 SAE fitting	2	1.25
BAC-80-10SAE	41446	Body, adapter/restrictor, #10 SAE male x 1/2" NPT female	1	26.50
BAC-78-10SAE	41442	Reverse check, #10 SAE male x 1/2" NPT female	1	36.50
55032	55032	Barrier fluid, quart (32 oz.)		61.50

FMC-855F-HYD 300 Flange x 300 Flange Hydraulic Motor Driven Pumps



PART NO.	EDP NO.	DESCRIPTION	REQ.	EACH
RK-FMC-855	52726	Repair kit for FMC-855F-HYD, includes "O" rings 40018, 40015, seal 40148, and barrier fluid 55032		536.50
20750	20750	Pipe plug, 1/4" NPT	4	6.50
BAC-12-855F	30154	Volute, 300 X 300 flange, cast iron, e-coated	1	2,385.50
40018	40018	O-ring, volute seal	1	17.50
40397	40397	Nut, acorn, 5/8"-11, stainless steel	1	17.50
BAC-26-855-CI	30198	Impeller, cast iron, e-coated	1	1,083.75
BAC-16-855	45263	Seal plate, cast iron, e-coated	1	1,090.25
41107	41107	Bushing, #8 SAE x 1/4" FNPT, with o-ring	1	14.25
41316	41316	Air valve, 1/4" NPT	1	17.25
BAC-4-150	40015	O-ring; seal plate to frame	1	9.25
BAC-7-850V	40148	Seal assembly, 1-1/4" type 21 double, carbon/ceramic/Viton®	1	369.25
BAC-14-855-HYD	40294	Mounting frame, cast iron, e-coated	1	1,878.50
40953	40953	Cap screw, 3/8" NC x 2-1/4" hex head	8	2.25
41907	41907	Cap screw, 3/8" NC x 1" socket head (4 for seal plate and 2 for motor)	6	3.75
41108	41108	Plug, #8 SAE, hex head	1	10.25
44039	44039	Bushing, #8 SAE x 1/8" FNPT, with o-ring	1	35.25
50150	50150	Pressure gauge, 0-60 PSI, 1/8" NPT	1	29.75
55851	55851	Sight gauge	1	55.00
GE-54	42220	Slinger	1	5.25
41945	41945	Snap ring, external	4	4.75
40876	40876	Bearing, front	1	51.75
41085	41085	Key, 3/16" x 3/16" x 7/8", impeller	1	1.50
BAC-6-850-HYD-SS	40065	Shaft, female 11T spline, stainless steel	1	640.50
40877	40877	Bearing, rear	1	65.00
BAC-75-HYD-M30	41357	Hydraulic motor, pressure plated gear type	1	1,240.25
42701	42701	Washer, 3/8", stainless steel	2	0.75
55032	55032	Barrier fluid, quart	2	61.50

PTOC

1-1/4" x 1" PTO Driven Pumps



PART NO.	EDP NO.	DESCRIPTION	REQ.	EACH
RK-PTOC-600	51150	Repair kit for PTOC-600 series, includes belt 40610, mechanical seal 40151, and "O" Ring 40005		136.25
RK-PTOC-1000	51250	Repair kit for PTOC-1000 series, includes belt 40620, mechanical seal 40151, and "O" Ring 40005		137.25
FMC-MIA	47000	Pump end only (PTOC models)		732.00
BGKB	52610	Belt and shaft guard kit for all PTOC centrifugal pumps	1	187.05
BAC-10-S	40190	1" Tumblerod stub drive shaft	1	396.75
BAC-10-175-20SP	40180	1 3/4" 20 Tooth spline PTO drive shaft, includes BAC-11-175	1	534.50
BAC-10-21SP	40220	1 3/8" 21 Tooth spline PTO drive shaft, includes BAC-11	1	507.00
40960	40960	Nut, 3/8" NC Jam type	1	0.75
BAC-40	40940	Set screw, 3/8" NC Slotted	3	1.25
BAC-11	40235	Split ring locking collar for 1 3/8" BAC-10-21SP shaft	1	141.25
BAC-11-175	40236	Split ring locking collar for 1 3/4" BAC-10-175-20SP shaft	1	192.00
BAC-11-1	40237	Set screw (for BAC-11 and BAC-11-175 locking collar)	1	1.25
BAC-10-6SPQC	40210	1 3/8" 6 Tooth spline PTO drive shaft for quick coupler	1	402.50
BAC-83-QC	41470	Ball for quick coupler	3	1.75
BAC-82-QC	41460	Spring for quick coupler	1	14.25
BAC-81-QC	41450	Ball retainer sleeve for quick coupler	1	39.25
41250	41250	Cap screw, 5/16" NC x 3 1/4" Hex head	1	2.25
41300	41300	Set screw, 3/8" NC x 5/8" Allen head	2	1.00
BAC-30-10-M	40750	Pulley, 6.375" P.D. x 2" bore Poly-V drive pulley, 10 groove (for PTOC-1000-21SP and -B)	1	314.00
BAC-30-175	40745	Pulley, 6.375" P.D. x 2 3/8" bore Poly-V drive pulley, 10 groove (for PTOC-1000-20SP)	1	338.50
BAC-63	41260	Nut, 5/16" NC Self-locking, for tumblerod drive	1	1.00
BAC-34	40830	Snap ring, internal, BAC-15 bearing housing	2	6.00
BAC-27	40520	Name plate for PTOC and PTOC-150 models	1	12.75
BAC-35	40840	Snap ring, external, BAC-10 drive shaft	1	1.25
BAC-31-1	40781	Bearing, BAC-10 drive shaft	2	59.50
BAC-38-1	40905	Spacer for BAC-10 drive shaft	1	44.75
BAC-44	40990	Washer, 3/8" Lock type	2	0.60
BAC-45	41010	Nut, 3/8" NC Hex	4	0.60
BAC-15	40340	PTO Drive shaft bearing housing	1	252.50
BAC-15-A-175	40353	PTO Drive shaft bearing housing assembly with 20 spline shaft	1	1,244.50
BAC-15-A-6SP	40351	PTO Drive shaft bearing housing assembly with 6 spline shaft	1	1,094.50
BAC-15-A-M	40360	PTO Drive shaft bearing housing assembly with 21 spline shaft	1	1,192.50
BAC-15-A-QC	40352	PTO Drive shaft bearing housing assembly with quick coupler on 6 spline shaft	1	1,100.25
BAC-15-B	40370	Tumblerod drive shaft bearing housing with mounting base	1	361.75
BAC-10-6SP	40200	1 3/8" 6 Tooth spline PTO drive shaft	1	396.75
BAC-51	41090	Key, 3/8" x 1/2" x 1 1/2", PTO drive shaft	1	6.75
BAC-30-10	40740	Pulley, 10.6" P.D. x 2" bore Poly-V drive pulley, 10 groove (for PTOC-600 models)	1	326.25
BAC-28-10	40610	Belt, 10 groove (for PTOC-600)	1	68.50
BAC-28-10-M	40620	Belt, 10 groove (for PTOC-1000)	1	69.50
BAC-53	41110	Pipe plug, 1/8" NPT	3	0.65
41120	41120	Pipe plug, 1/8" NPT, stainless steel (optional)	3	6.00
BAC-12	40250	Volute, 1 1/4" x 1", cast iron	1	307.50
BAC-26-VALOX	40430	Impeller, Valox, left hand thread	1	108.25
BAC-26-CI	40432	Impeller, cast iron, left hand thread (optional)	1	244.75
BAC-4A	40005	"O" Ring for BAC-12 volute seal, effective Apr. '96	1	9.25
BAC-7V	40151	Seal, Viton® mechanical seal (includes 40160 "O" Ring)	1	58.50
BAC-7B	40110	Seal, Buna N mechanical seal (includes 40160 "O" Ring)(optional)	1	66.00
BAC-7SC	40152	Seal, Silicon carbide mechanical seal (includes 40160 "O" Ring)(optional)	1	201.75
BAC-7SCB	40109	Seal, Silicon carbide mechanical seal, Buna elastomer (includes 40160 "O" Ring)(optional)	1	198.50
BAC-7SCE	40150	Seal, Silicon carbide mechanical seal, EPDM elastomer (includes 40169 "O" Ring)(optional)	1	296.75
40160	40160	"O" Ring for BAC-6 shaft	1	1.25
40169	40169	"O" Ring for BAC-6 shaft, EPDM	1	1.25
BAC-42	40970	Cap screw, 3/8" NC x 1 3/4" Hex head	2	1.75
BAC-43	40980	Washer, 3/8" Flat	2	0.60
BAC-14-MIA	40290	Mounting frame, machined for idler arm	1	338.50
BAC-15-PIN	40799	Alignment pin for PTOC pump	2	1.25
40950	40950	Cap screw, 3/8" NC x 3/4" Hex head	4	0.75
40930	40930	Cap screw, 3/8" NC x 3/4" Hex head, stainless steel (optional)	4	2.75
BAC-54	41130	Slinger	1	2.25
BAC-33	40810	Snap ring, internal, BAC-14 mounting frame	2	2.25
BAC-37	40870	Bearing, BAC-6 driven shaft	2	23.25
BAC-32	40790	Snap ring, external, BAC-6 driven shaft	2	0.75
BAC-32-S	40795	Spacer for BAC-6 shaft	1	7.00
BAC-6-SS	40070	Shaft, 5/8" Driven shaft, left hand thread, stainless steel	1	160.00
BAC-50	41080	Key for driven pulley, 3/16" x 3/16" x 1 1/4"	1	1.75
BAC-57	41180	Set screw, 5/16" NC x 5/16" Allen head for BAC-29-10 pulley	2	1.00
BAC-29-10-1.5	40680	Pulley, 1.5" P.D. x 5/8" bore Poly-V driven pulley, 10 groove (for PTOC-600 and -1000)	1	99.25
BAC-5	40030	Spring, torsion type for PTOC series idler arm	1	26.75
BAC-13	40270	Idler arm	1	108.25
BAC-36	40850	Snap ring, external, BAC-13 idler arm	1	2.25
BAC-46	41020	Spacer, 5/8"	1	35.25
BAC-49	41070	Retainer ring	1	0.75
BAC-55	41140	Idler bearing and roller	1	77.25
BAC-47	41040	Cap screw, 5/8" NC x 2 1/8" Hex head idler	1	9.50
BAC-52	41100	1/4" Cold shut, torque chain anchor	1	5.00
BAC-58	41190	Zerk fitting, 1/4" NPT, for idler arm	1	3.75
BAC-55-A	41150	Idler arm BAC-13 and roller assembly BAC-55	1	231.00
BAC-31-RETRO	40782	Retrofit kit, BAC-31 to BAC-31-1	1	202.50

BGKB

Belt and Shaft Guard Kits for all PTOC and PTOC-150 Models

PART NO.	EDP NO.	DESCRIPTION	REQ.	EACH
BGKB-1	41653	Plastic belt and shaft guard, left half facing tractor for PTOC and PTOC-150 centrifugal pumps	1	79.25
BGKB-2	41654	Plastic belt and shaft guard, right half facing tractor for PTOC and PTOC-150 centrifugal pumps	1	79.25
BGK-101	41660	Washer, 1/4" x 1 1/2" x 2" Steel rectangular washer	1	9.25
BGK-101-1	41661	Nut, 1/4" x 1 1/2" x 3 1/2" Steel rectangular nut	1	11.75
BGK-104-1	41695	Nut, 1/4" NC Wing nut	4	0.75
BGK-105-1	41705	Cap screw, 5/15" NC x 2 1/4" Hex head	1	1.75
BGK-106-1	41715	1/4" NC x 3/4" Carriage bolt	4	0.70

PTOC-150 and PTOC-150F

1-1/2" x 1-1/4" PTO Driven Pumps



PART NO.	EDP NO.	DESCRIPTION	REQ.	EACH
RK-PTOC-150-600	51155	Repair kit for PTOC-150-600 series, includes belt 40611, seal 40151, washer 40400, and "O" Ring 40015		142.75
RK-PTOC-150-1000	51255	Repair kit for PTOC-150-1000 series, includes belt 40621, seal 40151, washer 40400, and "O" Ring 40015		144.00
FMC-150-MIA	47008	Pump end only (PTOC-150 models)		740.00
BGKB	52610	Belt and shaft guard kit for all PTOC and PTOC-150 centrifugal pumps	1	187.05
BAC-10-S	40190	1" Stub drive shaft (for -B models)	1	396.75
BAC-10-21SP	40220	1 3/8" 21 Tooth spline PTO drive shaft, includes BAC-11	1	507.00
BAC-10-175-20SP	40180	1 3/4" 20 Tooth spline PTO drive shaft, includes BAC-11-175	1	534.50
40960	40960	Nut, 3/8" NC Jam type	3	0.75
BAC-40	40940	Set screw, 3/8" NC Slotted	3	1.25
BAC-11	40235	Split ring locking collar for 1 3/8" BAC-10-21SP shaft	1	141.25
BAC-11-175	40236	Split ring locking collar for 1 3/4" BAC-10-175-20SP shaft	1	192.00
BAC-11-1	40237	Set screw (for BAC-11 and BAC-11-175 locking collar)	1	1.25
BAC-10-6SPQC	40210	1 3/8" 6 Tooth spline PTO drive shaft for quick coupler	1	402.50
BAC-83-QC	41470	Ball for quick coupler	3	1.75
BAC-82-QC	41460	Spring for quick coupler	1	14.25
BAC-81-QC	41450	Ball retainer sleeve for quick coupler	1	39.25
41250	41250	Cap screw, 5/16" NC x 3 1/4" Hex head	1	2.25
BAC-30-10-M-150	40751	Pulley, 7.9" P.D. x 2" bore Poly-V driven pulley, 10 groove (for PTOC-150-1000-21SP and -B)	1	338.50
BAC-30-175-150	40746	Pulley, 7.9" P.D. x 2 3/8" bore Poly-V driven pulley, 10 groove (for PTOC-150-1000-20SP)	1	369.25
BAC-63	41260	Nut, 5/16" NC Self-locking, for tumblerod drive	1	1.00
BAC-34	40830	Snap ring, internal, BAC-15 bearing housing	2	6.00
BAC-27	40520	Name plate for PTOC and PTOC-150 models	1	12.75
BAC-35	40840	Snap ring, external, BAC-10 drive shaft	1	1.25
BAC-31-1	40781	Bearing, BAC-10 drive shaft	2	59.50
BAC-38-1	40905	Spacer for BAC-10 drive shaft	1	44.75
BAC-45	41010	Nut, 3/8" NC Hex	2	0.60
BAC-15	40340	PTO drive shaft bearing housing	1	252.50
BAC-15-B	40370	PTO drive shaft bearing housing with mounting base (for -B models)	1	361.75
BAC-10-6SP	40200	1 3/8" 6 Tooth spline PTO drive shaft	1	396.75
BAC-51	41090	Key, 3/8" x 1/2" x 1 1/2", PTO drive shaft (for -B models)	1	6.75
BAC-30-10-150	40741	Pulley, 11.6" P.D. x 2" bore Poly-V driven pulley, 10 groove (for PTOC-150-600 models)	1	345.00
41300	41300	Set screw, 3/8" NC x 5/8" Allen head	2	1.00
BAC-28-10-150	40611	Belt, 10 groove (for PTOC-150-600)	1	75.00
BAC-28-10M-150	40621	Belt, 10 groove (for PTOC-150-1000)	1	76.25
BAC-53	41110	Pipe plug, 1/8" NPT	3	0.65
41120	41120	Pipe plug, 1/8" NPT, stainless steel (optional)	3	6.00
BAC-12-150	40255	Volute, 1 1/2" x 1 1/4", cast iron	1	381.50
BAC-12-150-FLG	40257	Volute, 1 1/2" NPT/220 series flange suction x 1 1/4" NPT/200 series flange, cast iron (optional)	1	455.25
BAC-12-150-SS	40249	Volute, 1 1/2" NPT/220 series flange suction x 1 1/4" NPT/200 series flange, 316 stainless steel (optional)	1	1,016.25
BAC-23-A	40391	Nut, 3/8" NF Hex, cad plated locknut	1	2.75
BAC-24-HYD-SS	40400	Washer, 3/8", stainless steel	1	1.75
BAC-23-B-SS	40393	Nut, 3/8" NF Hex, stainless steel (effective 10/12 for -SS, 150FS, 200SS, and 205 models)	1	1.25
BAC-24-B-SS	42702	Washer, 3/8", stainless steel, vibration proof (effective 10/12 for -SS, 150FS, 200SS, and 205 models)	1	8.25
BAC-26-150-P	40446	Impeller, with keyway, thermoplastic	1	108.25
BAC-26-150-CI	40445	Impeller, cast iron, with keyway	1	266.75
BAC-26-150-PI	40448	Impeller, with keyway, polypropylene	1	113.50
BAC-26-150-SS	40449	Impeller, with keyway, stainless steel (optional)	1	426.75
BAC-4-150	40015	"O" Ring, volute seal	1	9.25
BAC-4-150-E	40016	"O" Ring, Volute seal, EPDM	1	10.75
BAC-7V	40151	Seal, Viton® mechanical seal (includes 40160 "O" Ring)	1	58.50
BAC-7B	40110	Seal, Buna N mechanical seal (includes 40160 "O" Ring)(optional)	1	66.00
BAC-7SC	40152	Seal, Silicon carbide mechanical seal (includes 40160 "O" Ring)(optional)	1	201.75
BAC-7SCB	40109	Seal, Silicon carbide mechanical seal, Buna elastomer (includes 40160 "O" Ring)(optional)	1	198.50
BAC-7SCE	40150	Seal, Silicon carbide mechanical seal, EPDM elastomer (includes 40169 "O" Ring)(optional)	1	296.75
40160	40160	"O" Ring for BAC-6 shaft	1	1.25
40169	40169	"O" Ring for BAC-6 shaft, EPDM	1	1.25
BAC-42	40970	Cap screw, 3/8" NC x 1 3/4" Hex head	2	1.75
BAC-43	40980	Washer, 3/8" Flat	2	0.60
BAC-14-150-MIA	40308	Mounting frame, machined for idler arm	1	401.25
BAC-44	40990	Washer, 3/8" Lock type	2	0.60
BAC-15-PIN	40799	Alignment pin for PTOC pumps	2	1.25
40950	40950	Cap screw, 3/8" NC x 3/4" Hex head	4	0.75
40930	40930	Cap screw, 3/8" NC x 3/4" Hex head, stainless steel (optional)	4	2.75
BAC-54	41130	Slinger	1	2.25
BAC-33	40810	Snap ring, internal, BAC-14 mounting frame	2	2.25
BAC-37	40870	Bearing, BAC-6 driven shaft	2	23.25
BAC-32	40790	Snap ring, external, BAC-6 driven shaft	2	0.75
BAC-32-S	40795	Spacer for BAC-6 shaft	1	7.00
BACH-25	40420	Key for impeller, 1/8" x 1/8" x 7/16"	1	1.25
BAC-6-150/200-SS	40056	Shaft, 5/8" Driven shaft with keyway, stainless steel	1	157.50
BAC-50	41080	Key for driven pulley, 3/16" x 3/16" x 1 1/4"	1	1.75
BAC-29-10-1.35	40675	Pulley, 1.35" P.D. x 5/8" bore Poly-V driven pulley, 10 groove (for PTOC-150-600)	1	99.25
BAC-29-10-1.7	40681	Pulley, 1.7" P.D. x 5/8" bore Poly-V driven pulley, 10 groove (for PTOC-150-1000)	1	99.25
BAC-57	41180	Set screw, 5/16" NC x 5/16" Allen head for BAC-29-10 pulley	2	1.00
BAC-5-150	40035	Spring, torsion type for PTOC-150 series idler arm	1	30.50
BAC-13	40270	Idler arm	1	108.25
BAC-36	40850	Snap ring, external, BAC-13 idler arm	1	2.25
BAC-46	41020	Spacer, 5/8"	1	35.25
BAC-49	41070	Retainer ring	1	0.75
BAC-55	41140	Idler bearing and roller	1	77.25
BAC-47	41040	Cap screw, 5/8" NC x 2 1/8" Hex head idler	1	9.50
BAC-31-RETRO	40782	Retrofit kit, BAC-31 to BAC-31-1 (includes 2 bearings and 2 spacers)	1	202.50
BAC-52	41100	1/4" Cold shut, torque chain anchor	1	5.00
BAC-55-A	41150	Idler arm BAC-13 and roller assembly BAC-55	1	231.00
BAC-58	41190	Zerk fitting, 1/4" NPT, for idler arm	1	3.75



GE-75, GE-85 and GE-85SP 1" x 3/4" Gasoline Engine Driven Pump

PART NO.	EDP NO.	DESCRIPTION	GE-75	GE-85	GE-85SP	EACH
RK-GE-75	60840	Repair kit, includes seal 42730, 5 washers 30028, "O" Ring 40159, and "O" Ring 40017	1			85.75
RK-GE-75-IMP	60849	Repair kit, includes impeller 42710, seal 42730, 5 washers 30028, "O" Ring 40159, and "O" Ring 40017	1			157.50
RK-GE-85	60845	Repair kit, includes seal 30225, 5 washers 30028, "O" Ring 40159, and "O" Ring 40017		1		100.25
RK-GE-85-IMP	60844	Repair kit, includes impeller 42711, seal 30225, 5 washers 30028, "O" Ring 40159, and "O" Ring 40017		1		172.00
RK-GE-85SP	60847	Repair kit, includes seal 30225, 5 washers 30028, "O" Ring 40159, "O" Ring 40014 and "O" Ring 40012			1	112.00
RK-GESC-75	60841	Repair kit, includes seal 42731, 5 washers 30028, "O" Ring 40159, and "O" Ring 40017	1			212.50
RK-GESC-85	60846	Repair kit, includes seal 30226, 5 washers 30028, "O" Ring 40159, and "O" Ring 40017		1		255.50
RK-GESC-85SP	60848	Repair kit, includes seal 30226, 5 washers 30028, "O" Ring 40159, "O" Ring 40014 and "O" Ring 40012			1	267.25
BAC-53-P	41109	Pipe plug, 1/8" NPT, plastic	1	1		2.25
41122	41122	Plug, volute			2	13.75
40191	40191	"O" Ring for 41122 fill and drain plugs			2	0.60
80250	80250	Cap screw, 3/8"-16 x 7/8", hex head	8	8		2.50
42237	42237	Cap screw, 5/16"-18 x 1-1/4", hex head			10	2.25
42701	42701	Washer, 3/8" flat	8	8		0.75
20730	20730	Washer; 5/16" flat			10	0.60
GE-12-75	42700	Volute, 3/4" x 1", polypropylene	1	1		152.00
GE-12-75SP	42708	Volute, 3/4" x 1", polypropylene			1	178.50
42240	42240	Cap screw, 1/4"-28 x 1", hex, stainless steel	1			3.75
GE-60-SS	42235	Cap screw, 5/16"-NF x 3/4", hex, stainless steel		1	1	1.75
30028	30028	Washer, sealing	5	5	5	2.25
GE-26-75	42710	Impeller, with keyway, polypropylene	1			71.75
GE-26-85	42711	Impeller, with keyway, polypropylene		1	1	71.75
41082	41082	Key, 3/16" x 3/16" x 15/16"	1	1	1	1.25
BAC-7-75V	42730	Seal, 5/8", Viton® type rubber	1			57.25
BAC-7SC-75V	42731	Seal, 5/8", Silicon Carbide/Viton® type rubber (optional)	1			184.00
BAC-7-660V	30225	Seal, 3/4", Viton® type rubber		1	1	71.75
BAC-7SC-660V	30226	Seal, 3/4", Silicon Carbide/Viton® (optional) (for GE-85)(optional)		1	1	227.00
42245	42245	Cap screw, M8 x 60, stainless steel (for mounting bracket to Honda motor)	4			5.00
42238	42238	Cap screw, 5/16"NF x 2-1/4"(for mounting bracket to Briggs motor)		4	4	3.50
40159	40159	"O" Ring, seat seal	1	1	1	1.25
40017	40017	"O" Ring, volute seal	1	1		16.00
40014	40014	"O" Ring, volute seal			1	16.00
40012	40012	"O" Ring, volute to diffuser seal			1	11.75
GE-14-75	42720	Bracket, polypropylene	1			161.00
GE-14-85	42721	Bracket, polypropylene		1		161.00
GE-14-85SP	42726	Bracket, GE-85, polypropylene			1	166.50
BAC-45	41010	Nut, hex, 3/8"	8	8		0.60
42270	42270	Nut, hex, 5/16" - 18			10	0.75
BAC-54	41130	Slinger	1			2.25
GE-54-660	42222	Slinger		1	1	7.25
42055	42055	Engine, 2.8 net HP, Honda GX100UA2	1			1,937.00
42076	42076	Gasoline engine, 4.5 H.P., Kohler CH245-3152, pull start, 3/4" keyed shaft		1	1	1,808.00

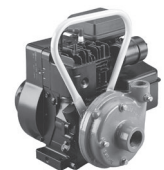

GE-100-A 1-1/4" x 1" Gasoline Engine Driven Pump

PART NO.	EDP NO.	DESCRIPTION	REQ.	EACH
RK-GE-100-A	60855	Repair kit for GE-100-A, includes Viton® seal 42120, gasket 31040, and 42132		102.75
BAC-53	41110	Pipe plug, 1/8" NPT	3	0.65
41120	41120	Pipe plug, 1/8" NPT, stainless steel (optional)	3	6.00
5AC-10	30100	Volute, 1 1/4" x 1", cast iron	1	350.50
GE-26-A	42161	Impeller, cast iron, right hand 5/8" thread (for use with GE-1-A engine)	1	257.00
GE-8-V-A	42132	"O" Ring for GE-6-A-SS, shaft sleeve, Viton®	1	3.75
GE-6-SS-A	42105	Sleeve for 1" O.D. shaft, stainless steel (for use with GE-1-A engine)	1	90.50
GE-7-V	42120	Seal, 1" Type 6 mechanical seal, Viton®	1	90.50
31040	31040	Gasket for 5AC-10 volute, 4 hole	1	7.25
GE-9-A	42151	Bracket (for use with GE-1-A engine)	1	330.75
GE-60	42230	Cap screw, 5/16" N.F. x 3/4"	2	0.75
GE-60-SS	42235	Cap screw, 5/16" N.F. x 3/4" Cap screw stainless steel (optional)	1	1.75
GE-54	42220	Slinger	1	5.25
40950	40950	Cap screw, 3/8" N.C. x 3/4" Hex head	4	0.75
40930	40930	Cap screw, 3/8" N.C. x 3/4" Hex head, stainless steel (optional)	4	2.75
GE-1-A	42060	3.5 HP Gasoline engine, Briggs & Stratton, 093332-0036	1	1,044.00

GE-650 and GE-660

1-1/2" x 1-1/4" Gasoline Engine Driven Pump



PART NO.	EDP NO.	DESCRIPTION	GE-650	GE-660	EACH
RK-GE-650	61153	Repair kit for GE-650, includes Viton® seal 42120, and "O" Rings 42132, 40015			103.50
RK-GE-660	61162	Repair kit for GE-660, includes Viton® seal 30225, 5 sealing washers 30028, and "O" Ring 40015			92.25
RK-GESC-660	61167	Repair kit for GE-660, includes silicon carbide seal 30226, 5 sealing washers 30028, and "O" Ring 40015			247.50
41120	41120	Pipe plug, 1/8" NPT, stainless steel (optional)	3	3	6.00
BAC-53	41110	Pipe plug, 1/8" NPT	3	3	0.65
ACAL-12	30161	Volute, 1 1/2" x 1 1/4", clockwise rotation	1	1	387.00
ACAL-12-EC	30196	Volute, 1 1/2" x 1 1/4", clockwise rotation, Ecoated		1	464.00
ACAL-28	30173	Impeller for GE-650	1		404.50
ACAL-28-660-P	30556	Impeller, GE-660, 3/4" keyed shaft, thermoplastic		1	138.75
ACAL-28-660	30171	Impeller, GE-660, 3/4" keyed shaft, CI (optional)		1	392.25
ACAL-28-660-EC	30195	Impeller, GE-660, 3/4" keyed shaft, Ecoated CI		1	452.00
GE-6-SS-A	42105	Sleeve for 1" O.D. shaft, stainless steel (for use with GE-I-A engine)	1		90.50
GE-8-V-A	42132	"O" Ring for GE-6-A-SS, shaft sleeve, Viton®	1		3.75
41081	41081	Key, 3/16" x 3/16" x 3/4", for GE-660		1	1.25
GE-7-V	42120	Seal, 1" Type 6 mechanical seal, Viton®	1		90.50
BAC-7-660V	30225	Seal, Type 6A-3/4, carbon/ceramic, Viton®		1	71.75
BAC-7SC-660V	30226	Seal, Type 6A-3/4, silicon carbide, Viton® (optional)		1	227.00
BAC-4-150	40015	"O" Ring, volute seal	1	1	9.25
ACAL-55	30185	Bracket for GE-650	1		595.50
ACAL-66	30186	Bracket, GE-660		1	375.00
ACAL-66-EC	30197	Bracket, Ecoated, GE-660		1	434.50
40930	40930	Cap screw, 3/8" N.C. x 3/4" Hex head, stainless steel (optional)	4	8	2.75
40950	40950	Cap screw, 3/8" N.C. x 3/4" Hex head	4	8	0.75
GE-54	42220	Slinger	1		5.25
GE-54-660	42222	Slinger, GE-660		1	7.25
GE-60	42230	Cap screw, 5/16" N.F. x 3/4"	4		0.75
GE-60-SS	42235	Cap screw, 5/16" N.F. x 3/4" Cap screw stainless steel (optional)	4	5	1.75
30031	30031	Washer, Stat-O-Seal, 5/16" ID, impeller bolt (effective 10/11)		1	5.00
30028	30028	Washer, sealing, 5/16"		4	2.25
42068	42068	4.8 net H.P. Gasoline engine, Honda GX160UT2TX2, TH	1		2,270.75
42069	42069	5.5 H.P. Gasoline engine, Briggs & Stratton 126332-0035	1		1,663.50
42061	42061	5.5 H.P. Gasoline engine, B&S 1220320536, pull start, 3/4" keyed shaft		1	1,436.50
42062	42062	4.8 net H.P. Gasoline engine, Honda GX160UT2QX2, pull start, 3/4" keyed shaft		1	2,024.00
42064	42064	4.8 net H.P. Gasoline engine, Honda GX160UT2QXE2, electric start, 3/4" keyed shaft		1	2,976.50

GE-800, GE-860 and GE-1600

2" x 1-1/2" & 2-1/2" x 2" Gasoline Engine Driven Pump



PART NO.	EDP NO.	DESCRIPTION	GE-800	GE-860	GE-1600	EACH
RK-GE-800/1600	61000	Repair kit for GE-800 and GE-1600, includes Viton® seal 30265, gasket 31130, and "O" rings 41860, 72990				170.75
RK-GE-800/1600-SG	61005	Repair kit for GE-800 and GE-1600, includes seal 30266, gasket 31130, and "O" rings 41860, 72990				364.75
RK-GE-860/1660	61010	Repair kit for GE-860, includes seal 30267, "O"-rings ACAL-4 & 41865, sealing washers 30023 & 30028				188.25
BAC-53	41110	Pipe plug, 1/8" NPT	3	3	3	0.65
41120	41120	Pipe plug, 1/8" NPT, stainless steel (optional)	3	3	3	6.00
ACAL-14	30160	Volute, 2" x 1-1/2", clockwise rotation, cast iron, for GE-800	1	1		492.75
ACAL-16	30170	Volute, 2-1/2" x 2", clockwise rotation, cast iron, for GE-1600			1	737.50
ACAL-26-TH	30047	Impeller, cast iron, 1" UNF right hand thread for GE-800	1			565.50
ACAL-26-860	30558	Impeller, GE-860, cast iron with keyway		1		565.50
ACAL-30-1600	30561	Impeller, cast iron, 1" UNF right hand thread for GE-1600			1	545.75
41083	41083	Key, 1/4" x 1/4" x 7/8"		1		1.25
72990	72990	"O" ring, shaft sleeve, impeller side	1		1	3.75
41865	41865	"O" Ring, impeller		1		2.25
ACAL-7-SS	30018	Sleeve for engine shaft, stainless steel	1		1	231.50
42108	42108	Shaft sleeve, GE-860, stainless steel		1		160.00
41860	41860	"O" ring, shaft sleeve, engine side	1		1	2.25
TYPE 21-1.250	30265	Seal, type 21 mechanical seal for 1.25" shaft, Viton®	1		1	155.50
TYPE 21-1.250-SG	30266	Seal, type 21 mechanical seal for 1.25" shaft, Viton®, siliconized graphite	1		1	337.25
TYPE 21-1.250-V60	30267	Seal, 1.25" Type 21 mechanical seal, Viton®		1		161.00
ACAL-4	30009	"O" ring gasket for ACAL-14 volute with chamfer	1	1	1	14.25
ACAL-143	30045	Bracket for use with GE-800 and GE-1600	1		1	583.25
ACAL-88	30187	Bracket, cast iron		1		535.75
40950	40950	Cap screw, 3/8" NC x 3/4" hex head	8	8	8	0.75
40930	40930	Cap screw, 3/8" NC x 3/4" hex head, stainless steel (optional)	8	8	8	2.75
GE-55	42221	Slinger (for use with GE-800)	1		1	7.50
GE-54	42220	Slinger, 1" ID x 1-5/8" OD x 1/8"		1		5.25
30022	30022	Cap screw, 7/16"-20 UNF x 1-1/2", stainless steel, impeller		1		3.00
30023	30023	Washer, 7/16" sealing, impeller bolt		1		1.75
GE-60-SS	42235	Cap screw, 5/16" NF x 3/4", stainless steel (optional on GE-800/1600)	4	4	4	1.75
30028	30028	Washer, 5/16" sealing, stainless steel, bracket to engine		4		2.25
GE-44	42200	Lockwasher, 5/16"	4		4	1.25
42067	42067	Gas engine, 7.9 net HP Honda, electric start, GX240UT2QAE2		1		3,941.00
42072	42072	Gas engine, 7.9 net HP Honda, pull start, GX240UT2QA2		1		3,086.75

FMC and FMC-200 Frame Mounted Counterclockwise Rotation Pumps



PART NO.	EDP NO.	DESCRIPTION	FMC	FMC-200	EACH
RK-FMC	52700	Repair kit for FMC series, includes carbon/ceramic/Viton® seal 40151, gasket 40010, and "O" Ring 40005			69.50
RK-FMCS	52706	Repair kit for FMC series, includes silicon carbide/Viton® seal 40152, gasket 40010, and "O" Ring 40005			212.75
BAC-53	41110	Pipe plug, 1/8" NPT	3	3	0.65
41120	41120	Pipe plug, 1/8" NPT, stainless steel (optional)	3	3	6.00
BAC-12	40250	Volute, 1 1/4" x 1", cast iron	1		307.50
7AC-14-CCW	41526	Volute, 2" x 1 1/2", cast iron (for FMC-200)		1	418.75
7AC-14-CCW-SS	41531	Volute, 2" x 1 1/2", stainless steel, use with BAC-14-LIN (for 200SS models)		1	879.75
BAC-23-A	40391	Nut, 3/8" NF Hex, cad plated locknut	1	1	2.75
BAC-24-HYD-SS	40400	Washer, 3/8" stainless steel	1	1	1.75
BAC-23-B-SS	40393	Nut, 3/8" NF Hex, stainless steel (effective 10/12 for -SS, 150FS, 200SS, and 205 models)	1	1	1.25
BAC-24-B-SS	42702	Washer, 3/8", stainless steel, vibration proof (effective 10/12 for -SS, 150FS, 200SS, and 205 models)	1	1	8.25
BAC-26-VALOX	40430	Impeller, Valox, left hand thread	1		108.25
BAC-26-CI	40432	Impeller, cast iron, left hand thread (optional)	1		244.75
BAC-26-200-P	40434	Impeller, 5 1/2" dia., with keyway, thermoplastic, available Dec. '99		1	156.50
BAC-26-200-CI	40433	Impeller, 5 1/2" dia., with keyway, cast iron, (for FMC-200 effective 10/98) (optional)		1	326.25
BAC-26-200-SS	40436	Impeller, 5 1/2" dia., with keyway, stainless steel (optional)		1	445.50
BAC-4A	40005	"O" Ring for BAC-12 volute seal, effective Apr. '96	1	1	9.25
BAC-7V	40151	Seal, Viton® mechanical seal (includes 40160 "O" Ring)	1		58.50
BAC-7B	40110	Seal, Buna N mechanical seal (includes 40160 "O" Ring)(optional)	1		66.00
BAC-7SC	40152	Seal, Silicon carbide mechanical seal (includes 40160 "O" Ring)(optional)	1		201.75
BAC-7SCB	40109	Seal, Silicon carbide mechanical seal, Buna elastomer (includes 40160 "O" Ring)(optional)	1		198.50
BAC-7SCE	40150	Seal, Silicon carbide mechanical seal, EPDM elastomer (includes 40169 "O" Ring)(optional)	1		296.75
40160	40160	"O" Ring for BAC-6 shaft	1	1	1.25
40169	40169	"O" Ring for BAC-6 shaft, EPDM	1		1.25
BAC-14-LIN	40336	Liner, stainless steel, for use with BAC-14X-MIA-LIN frame	1	1	170.75
BAC-14-F	40310	Mounting frame	1	1	319.75
BAC-14-MIA	40290	Mounting frame, machined for idler arm (for MIA and MAG-D models)	1	1	338.50
BAC-14X-F	40309	Mounting frame, X series pumps	1	1	425.50
BAC-14X-MIA	40313	Mounting frame, X series, machined for idler arm (for MIA and MAG-DX models)	1	1	474.00
BAC-14X3-MIA	40316	Mounting frame, X series, 3" mounting holes, machined for idler arm (for MAG-DX3 models)	1	1	448.75
BAC-14X-MIA-LIN	40296	Mounting frame, machined for idler arm (for 200SS-MAG-DX models)	1	1	490.50
40950	40950	Cap screw, 3/8" NC x 3/4" Hex head	4	4	0.75
40930	40930	Cap screw, 3/8" NC x 3/4" Hex head, stainless steel (optional)	4	4	2.75
BAC-54	41130	Slinger	1	1	2.25
BAC-33	40810	Snap ring, internal	2	2	2.25
BAC-33X	40812	Snap ring, internal, X models	2	2	3.75
BAC-37	40870	Bearing	2	2	23.25
BAC-37X	40872	Bearing, X models	2	2	34.75
BAC-32	40790	Snap ring, external	2	2	0.75
BAC-32X	40792	Snap ring, external, X models	2	2	1.25
BAC-32-S	40795	Spacer	1	1	7.00
BAC-32X-S	40796	Spacer for X models	1	1	37.50
BAC-6-SS	40070	Shaft, 5/8" Driven shaft, left hand thread, stainless steel	1		160.00
BAC-6-200-SS	40057	Shaft, 5/8" Driven shaft with keyway, stainless steel	1	1	150.00
BAC-6-D-SS	40071	Shaft, MAG-D, 5/8" Driven shaft, left hand thread, 5/16" hole, stainless steel		1	194.00
BAC-6-200-D-SS	40058	Shaft, MAG-D, 5/8" Driven shaft, .922" keyway, 5/16" hole, stainless steel		1	182.00
BAC-6X-SS	41509	Shaft, X models, 3/4" Driven shaft, left hand thread, stainless steel	1		270.25
BAC-6X-200-SS	40054	Shaft, X models, 3/4" Driven shaft with keyway, stainless steel		1	270.25
BAC-6X-D-SS	41517	Shaft, MAG-DX, left hand thread, 5/16" hole, stainless steel	1		270.25
BAC-6X-200-D-SS	40059	Shaft, MAG-DX, 5/16" hole, stainless steel		1	275.50
BAC-25	40425	Key, 1/8" x 1/8" x 13/16" (for FMC-200 effective 10/98)		1	1.25
BAC-50	41080	Key, 3/16" x 3/16" x 1 1/4"	1	1	1.75

FMC-150, FMC-150F, FMC-150FS and FMC-150SP 1-1/2" x 1-1/4" Frame Mounted Counterclockwise Rotation Pumps



PART NO.	EDP NO.	DESCRIPTION	REQ.	EACH
RK-FMC-150	52710	Repair kit for FMC-150, includes carbon/ceramic/Viton® seal 40151, and "O" Ring 40015		69.50
RK-FMCS-150	52711	Repair kit for FMC-150, includes silicon carbide/Viton® mechanical seal 40152, and "O" Ring 40015		212.75
BAC-53	41110	Pipe plug, 1/8" NPT	3	0.65
41120	41120	Pipe plug, 1/8" NPT, stainless steel (optional)	3	6.00
BAC-12-150	40255	Volute, 1 1/2" X 1 1/4", cast iron	1	381.50
BAC-12-150-FLG	40257	Volute, 1-1/2" NPT and 220 full port flange x 1-1/4" NPT and 200 standard port flange	1	455.25
BAC-12-150-SP	40254	Volute, 1 1/2" X 1 1/4", self-priming, cast iron	1	952.50
BAC-12-150-SS	40249	Volute, 1 1/2" NPT & 220 full port flange x 1 1/4" NPT & 200 standard port flange, 316 stainless steel	1	1,016.25
BAC-23-A	40391	Nut, 3/8" NF Hex, cad plated locknut	1	2.75
BAC-24-HYD-SS	40400	Washer, 3/8", stainless steel	1	1.75
BAC-23-B-SS	40393	Nut, 3/8" NF Hex, stainless steel (effective 10/12 for -SS, 150FS, 200SS, and 205 models)	1	1.25
BAC-24-B-SS	42702	Washer, 3/8", stainless steel, vibration proof (effective 10/12 for -SS, 150FS, 200SS, and 205 models)	1	8.25
BAC-26-150-P	40446	Impeller, with keyway, thermoplastic	1	108.25
BAC-26-150-CI	40445	Impeller, cast iron, with keyway (optional)	1	266.75
BAC-26-150-PI	40448	Impeller, with keyway, polypropylene (optional)	1	113.50
BAC-26-150-SS	40449	Impeller, with keyway, stainless steel (optional)	1	426.75
BAC-4-150	40015	"O" Ring, Volute seal	1	9.25
BAC-4-150-E	40016	"O" Ring, Volute seal, EPDM (optional)	1	10.75
BAC-7V	40151	Seal, Viton® mechanical seal (includes 40160 "O" Ring)	1	58.50
BAC-7B	40110	Seal, Buna N mechanical seal (includes 40160 "O" Ring)(optional)	1	66.00
BAC-7SC	40152	Seal, Silicon carbide mechanical seal (includes 40160 "O" Ring)(optional)	1	201.75
BAC-7SCB	40109	Seal, Silicon carbide mechanical seal, Buna elastomer (includes 40160 "O" Ring)(optional)	1	198.50
BAC-7SCE	40150	Seal, Silicon carbide mechanical seal, EPDM elastomer (includes 40169 "O" Ring)(optional)	1	296.75
40160	40160	"O" Ring for BAC-6 shaft	1	1.25
40169	40169	"O" Ring for BAC-6 shaft, EPDM (optional)	1	1.25
BAC-14-150-F	40306	Mounting frame	1	401.25
BAC-14-150-HYD-SS	40319	Mounting frame, 316 stainless steel	1	1,067.00
BAC-14-150-MIA	40308	Mounting frame, machined for idler arm (for MIA and MAG-D models)	1	401.25
40950	40950	Cap screw, 3/8" NC x 3/4" Hex head	4	0.75
40930	40930	Cap screw, 3/8" NC x 3/4" Hex head, stainless steel (optional)	4	2.75
BAC-54	41130	Slinger	1	2.25
BAC-33	40810	Snap ring, internal, BAC-14 mounting frame	2	2.25
BAC-37	40870	Bearing, BAC-6 driven shaft	2	23.25
BAC-32	40790	Snap ring, external, BAC-6 driven shaft	2	0.75
BAC-32-S	40795	Spacer for BAC-6 shaft	1	7.00
BAC-25	40420	Key for impeller, 1/8" x 1/8" x 1/2"	1	1.25
BAC-6-150/200-SS	40056	Shaft, 5/8" Driven shaft with keyway, stainless steel	1	157.50
BAC-6-150-D-SS	40076	Shaft, 5/8" Driven shaft with keyway, 5/16" hole, stainless steel, (for -D models)	1	200.75
BAC-50	41080	Key, 3/16" x 3/16" x 1 1/4"	1	1.75

FMC-650, FMC-650F, FMCWS-650, and FMCWS-650FS 1-1/2" x 1-1/4" Frame Mounted Counterclockwise Rotation Pumps



PART NO.	EDP NO.	DESCRIPTION	REQ.	EACH
RK-FMC-650	52720	Repair kit, includes volute "O" Ring 40015, washer 30029, and Viton® seal 40145		123.75
RK-FMCS-650	52721	Repair kit, includes volute "O" Ring 40015, washer 30029, and silicon carbide seal 40146		248.50
RK-FMCWS-650	52722	Repair kit, includes "O" ring 40015 (2 each), washer 30029, dual seal 40143, and barrier fluid 55032 (1 quart)		308.25
BAC-53	41110	Pipe plug, 1/8" NPT	3	0.65
41120	41120	Pipe plug, 1/8" NPT, stainless (optional, standard on FS models)	3	6.00
BAC-12-650	30163	Volute, 1-1/2" NPT X 1-1/4" NPT CCW rotation, cast, e-coated	1	469.50
BAC-12-650-FLG	30159	Volute, 1-1/2" NPT and 220 full port flange x 1-1/4" NPT and 200 standard port flange, cast, e-coated (F models)	1	567.75
BAC-12-650-FLG-SS	30156	Volute, 1-1/2" NPT and 220 full port flange x 1-1/4" NPT and 200 standard port flange, 316 stainless steel (FS models)	1	1,079.25
BAC-4-150	40015	"O" Ring for volute (2 for WS models)	1	9.25
40930	40930	Cap screw, 3/8" NC x 3/4" hex head stainless steel	1	2.75
30029	30029	Washer, 3/8" stainless steel sealing	1	2.25
BAC-26-650	30169	Impeller, cast iron, e-coated	1	317.50
BAC-26-650-SS	30191	Impeller, 316 stainless steel (FS models and optional)	1	555.50
BAC-26-650-WS	30192	Impeller, cast iron, e-coated (WS models)	1	372.50
BAC-26-650-WS-SS	30193	Impeller, stainless steel (WS-650FS models)	1	600.75
BAC-16-650	45262	Seal plate, cast iron, e-coated, (WS models)	1	518.25
BAC-16-650-LIN	40344	Liner seal plate, stainless steel (650FS non-WS models)	1	433.25
BAC-16-650-A-SS	45283	Seal plate, stainless steel, (WS-650FS models)	1	854.25
41107	41107	Plug, #8 SAE x 1/4" FNTP, hex, with o-ring, wetseal	1	14.25
41316	41316	Air valve, 1/4" NPT, wetseal	1	17.25
41108	41108	Plug, #8 SAE, hex head, with o-ring (WS models)	1	10.25
44039	44039	Bushing, #8 SAE x 1/8" FNTP (WS models)	1	35.25
50150	50150	Pressure gauge, 0-60 PSI, 1/8" NPT (WS models)	1	29.75
55851	55851	Site gauge, steel, #8 SAE, with float (WS models)	1	55.00
BAC-7-650	40145	Seal, carbon/ceramic/Viton®	1	112.25
BAC-7-650-WS	40143	Dual seal assembly, Type 21, .750 shaft, (WS models)	1	226.00
BAC-7SC-650	40146	Seal, silicon carbide mechanical seal (optional for non-WS models)	1	237.00
41907	41907	Cap screw, 3/8" NC x 1" socket head, stainless steel (WS models)	4	3.75
40950	40950	Cap screw, 3/8" NC x 3/4" Hex Head	8	0.75
BAC-14-650-MAG	40297	Mounting frame, cast iron, e-coated (for MAG-D models)	1	678.00
BAC-14-650-LIN	40349	Mounting frame, cast iron (for 650FS non-WS models)	1	702.00
BAC-42	40970	Cap screw, 3/8" NC x 2" hex head, (WS models)	4	1.75
BAC-54-650	41132	Slinger	1	6.00
ACAL-32	30174	Snap ring, external, BAC-6-650-D-SS	1	2.25
41943	41943	Snap ring, internal, BAC-6-650-D-SS	2	4.75
40875	40875	Bearing, BAC-6-650-D-SS driven shaft	2	51.75
BAC-32-650	40794	Spacer for BAC-6-650-D-SS	1	54.00
BAC-6-650-SS	40053	Shaft, 1" driven, stainless steel	1	302.00
BAC-6-650-D-SS	40052	Shaft, 1" driven, -D clutch keyed, stainless steel	1	307.50
BAC-6-650-SS-WS	40047	Shaft, 1" driven, stainless steel (WS models)	1	356.25
41085	41085	Key, 3/16" x 3/16" x 7/8" (for impeller)	1	1.50
BAC-50	41080	Key, 3/16" x 3/16" x 1-1/4" (for pulley)	1	1.75
55032	55032	Barrier fluid, quart (32 oz.) (WS models)		61.50

MAG-D Clutch Components for MAG-D models



PART NO.	EDP NO.	DESCRIPTION	REQ.	EACH
41491	41491	Adapter plate, -D clutch, (FMC, 150, 200 models)	1	242.50
41474	41474	Adapter plate, -D clutch (650 Max Series)	1	233.75
41484	41484	Adapter plate, -D clutch (FMC-CW-800-MAG-D)	1	270.25
41473	41473	Adapter plate, -D clutch ("X" series pumps)	1	233.75
BAC-36	40850	Snap ring for adapter plate (FMC, 150, 200 models)	1	2.25
41942	41942	Snap ring for adapter plate (650 Max Series)	1	7.00
41483	41483	Snap ring for adapter plate (FMC-CW-800-MAG-D)	1	6.00
BAC-36X	40855	Snap ring for adapter plate ("X" series pumps)	1	3.75
41492	41492	Spacer, -D clutch	1	26.50
41494	41494	Washer, -D clutch	1	3.75
GE-60	42230	Cap screw, 5/16" NF x 3/4"; -D clutch attachment	1	0.75
41496	41496	Coil ring with 4 cap screws, -D clutch	1	402.50
41497	41497	Pulley assembly, 5" diameter, -D clutch (FMC, 150, 200 models and "X" series pumps)	1	661.50
41482	41482	Pulley assembly, 5" diameter, tapered (800-MAG-D & 650 Max Series)	1	897.25
41493	41493	Clutch assembly, -D clutch, dual belt, 58 ft-lb, 5/8" keyed shaft (FMC, 150, 200 models and "X" series pumps)	1	803.75
41481	41481	Clutch assembly, dual belt, 58 ft-lb, tapered (800-MAG-D & 650 Max Series)	1	977.75



FMC-CW-75 and FMC-CW-75SP

1" x 3/4" Frame Mounted Clockwise Rotation Pumps

PART NO.	EDP NO.	DESCRIPTION	FMC-CW-75	FMC-CW-75SP	EACH
RK-GE-75	60840	Repair kit, includes seal 42730, 5 washers 30028, "O" Ring 40159, and "O" Ring 40017	1		85.75
RK-GE-75-IMP	60849	Repair kit, includes impeller 42710, seal 42730, 5 washers 30028, "O" Ring 40159, and "O" Ring 40017	1		157.50
RK-FMC-75SP	60842	Repair kit, includes seal 42730, 5 washers 30028, "O" Ring 40159, "O" Ring 40014, and "O" Ring 40012		1	97.50
RK-GE75C-75	60841	Repair kit, includes seal 42731, 5 washers 30028, "O" Ring 40159, and "O" Ring 40017	1		212.50
RK-FMCSC-75SP	60843	Repair kit, includes seal 42731, 5 washers 30028, "O" Ring 40159, "O" Ring 40014, and "O" Ring 40012		1	224.25
BAC-53-P	41109	Pipe plug, 1/8" NPT, plastic	1		2.25
41122	41122	Pipe plug, fill/drain, 1/2" NPT, plastic		2	13.75
40191	40191	"O" Ring for 41122 fill/drain plugs		2	0.60
80250	80250	Cap screw, 3/8"-16 x 7/8", hex head	8		2.50
42237	42237	Cap screw, 5/16"-18 x 1-1/4", hex head		10	2.25
42701	42701	Washer, 3/8" flat	8		0.75
20730	20730	Washer, 5/16" flat		10	0.60
GE-12-75	42700	Volute, 1" x 3/4", polypropylene, CW	1		152.00
GE-12-75SP	42708	Volute, 3/4" x 1", self-priming, polypropylene, CW		1	178.50
GE-12-75SP-CCW	42707	Volute, 3/4" x 1", self-priming, polypropylene, CCW			178.50
42240	42240	Cap screw, 1/4"-28 x 1", hex, stainless steel, impeller	1	1	3.75
30028	30028	Washer, sealing	5	5	2.25
GE-26-75	42710	Impeller, with keyway, polypropylene	1	1	71.75
42238	42238	Cap screw, 5/16" NF x 2-1/4"	4	4	3.50
40159	40159	"O" Ring, seal seat	1	1	1.25
BAC-7-75V	42730	Seal, 5/8", Viton® type rubber	1	1	57.25
BAC-75C-75V	42731	Seal, 5/8", silicon carbide mechanical seal, Viton® elastomer (optional)	1	1	184.00
40017	40017	"O" Ring, volute seal	1		16.00
40014	40014	"O" Ring, volute seal		1	16.00
40012	40012	"O" Ring, volute to diffuser seal		1	11.75
GE-14-75	42720	Bracket, polypropylene	1		161.00
GE-14-75SP	42725	Bracket, polypropylene		1	166.50
BAC-45	41010	Nut, hex, 3/8"	8		0.60
42270	42270	Nut, hex, 5/16"		10	0.75
BAC-14-75-HYD	40293	Mounting frame	1	1	314.00
BAC-54	41130	Slinger	1	1	2.25
BAC-33	40810	Snap ring, internal, BAC-14 mounting frame	2	2	2.25
BAC-37	40870	Bearing, BAC-6 driven shaft	2	2	23.25
BAC-32	40790	Snap ring, external, BAC-6 driven shaft	2	2	0.75
BAC-32-S	40795	Spacer for BAC-6 shaft	1	1	7.00
41082	41082	Key, 3/16" x 3/16" x 15/16"	1	1	1.25
BAC-6-75-SS	40046	Shaft, 5/8" Driven shaft with keyway, stainless steel	1	1	150.00
BAC-50	41080	Key, 3/16" x 3/16" x 1-1/4"	1	1	1.75



FMC-CW, FMC-CW-150, and FMC-CW-200

Frame Mounted Clockwise Rotation Including -X Models

PART NO.	EDP NO.	DESCRIPTION	FMC-CW	FMC-CW-150	FMC-CW-200	EACH
RK-FMC	52700	Repair kit, includes carbon/ceramic/Viton® seal 40151 and "O" Ring 40005				69.50
RK-FMCSC	52706	Repair kit, includes silicon carbide/Viton® seal 40152 and "O" Ring 40005				212.75
BAC-53	41110	Pipe plug, 1/8" NPT	3	3	3	0.65
41120	41120	Pipe plug, 1/8" NPT, stainless steel (optional)	3	3	3	6.00
BAC-12-CW	40253	Volute, 1 1/4" x 1", clockwise rotation, cast iron	1			307.50
6AC-12	30130	Volute, 1 1/2" x 1 1/4", clockwise rotation, cast iron		1		381.50
7AC-14-4	30145	Volute, 2" x 1 1/2", clockwise rotation, cast iron			1	418.75
BAC-26-CW-150-P	41510	Impeller, thermoplastic, right hand NF thread, for FMC-CW and FMC-150-CW	1	1		108.25
BAC-26-CW-150-CI	41515	Impeller, cast iron, right hand NF thread, for FMC-CW and FMC-CW-150 (optional)	1	1		244.75
BAC-26-CW-200-P	41523	Impeller, thermoplastic, right hand NF thread, for FMC-CW-200			1	162.00
BAC-26-CW-200-CI	41520	Impeller, cast iron, right hand NF thread, for FMC-CW-200 (optional)			1	326.25
BAC-4A	40005	"O" Ring for BAC-12 volute seal, effective Apr. '96	1	1	1	9.25
BAC-7V	40151	Seal, Viton® mechanical seal (includes 40160 "O" Ring)	1	1	1	58.50
BAC-7B	40110	Seal, Buna N mechanical seal (includes 40160 "O" Ring)(optional)	1	1	1	66.00
BAC-75C	40152	Seal, Silicon carbide mechanical seal (includes 40160 "O" Ring)(optional)	1	1	1	201.75
BAC-75CB	40109	Seal, Silicon carbide mechanical seal, Buna elastomer (includes 40160 "O" Ring)(optional)	1	1	1	198.50
BAC-75CE	40150	Seal, Silicon carbide mechanical seal, EPDM elastomer (includes 40169 "O" Ring)(optional)	1	1	1	296.75
40160	40160	"O" Ring for BAC-6 shaft	1	1	1	1.25
40169	40169	"O" Ring for BAC-6 shaft, EPDM (optional)	1	1	1	1.25
BAC-14-F	40310	Mounting frame	1	1	1	319.75
BAC-14-MIA	40290	Mounting frame, machined for idler arm (for MIA and MAG-D models)	1	1	1	338.50
BAC-14X-F	40309	Mounting frame (for -X model pumps)	1	1	1	425.50
BAC-14X-MIA	40313	Mounting frame (for -X MIA and MAG-DX models)	1	1	1	474.00
BAC-14X3-MIA	40316	Mounting frame (for MAG-DX3 models)	1	1	1	448.75
40950	40950	Cap screw, 3/8" NC x 3/4" Hex head	4	4	4	0.75
40930	40930	Cap screw, 3/8" NC x 3/4" Hex head, stainless steel (optional)	4	4	4	2.75
BAC-54	41130	Slinger	1	1	1	2.25
BAC-33	40810	Snap ring, internal	2	2	2	2.25
BAC-33X	40812	Snap ring, internal, X models	1	1	1	3.75
BAC-37	40870	Bearing	2	2	2	23.25
BAC-37X	40872	Bearing, X models	1	1	1	34.75
BAC-32	40790	Snap ring, external	2	2	2	0.75
BAC-32X	40792	Snap ring, external, X models	1	1	1	1.25
BAC-32-S	40795	Spacer	1	1	1	7.00
BAC-32X-S	40796	Spacer for X models	1	1	1	37.50
BAC-6-CW-SS	41500	Shaft, 5/8" Driven, right hand NF thread, stainless steel	1	1	1	176.25
BAC-6-CW-D-SS	41501	Shaft, MAG-D, 5/8" Driven, right hand NF thread, 5/16" hole, stainless steel	1	1	1	194.00
BAC-6X-CW-SS	41504	Shaft, -X models, 3/4" Driven, right hand NF thread, stainless steel	1	1	1	270.25
BAC-6X-CW-D-SS	41507	Shaft, MAG-DX models, right hand NF thread, stainless steel	1	1	1	270.25
BAC-50	41080	Key, 3/16" x 3/16" x 1 1/4"	1	1	1	1.75

FMC-CW-650 and FMCWS-CW-650

1-1/2" x 1-1/4" Frame Mounted Clockwise Rotation Pumps



PART NO.	EDP NO.	DESCRIPTION	REQ.	EACH
RK-FMC-650	52720	Repair kit, includes volute "O" Ring 40015, washer 30029, and Viton® seal 40145		123.75
RK-FMCSC-650	52721	Repair kit, includes volute "O" Ring 40015, washer 30029, and silicon carbide seal 40146		248.50
RK-FMCWS-650	52722	Repair kit, includes "O" ring 40015 (2 each), washer 30029, dual seal 40143, and barrier fluid 55032 (1 quart)		308.25
BAC-53	41110	Pipe plug, 1/8" NPT	3	0.65
41120	41120	Pipe plug, 1/8" NPT, stainless steel (optional)	3	6.00
ACAL-12-650	30155	Volute, 1-1/2" X 1-1/4" CW rotation, cast, e-coated	1	455.25
BAC-4-150	40015	"O" Ring for BAC-12-650 volute seal	1	9.25
40930	40930	Cap screw, 3/8" NC x 3/4" Hex Head Stainless Steel	1	2.75
30029	30029	Washer, 3/8" stainless steel sealing	1	2.25
BAC-26-650	30169	Impeller, cast iron, e-coated	1	317.50
BAC-26-650-SS	30191	Impeller, 316 stainless steel (FS models and optional)	1	555.50
BAC-26-650-WS	30192	Impeller, cast iron, e-coated (WS models)	1	372.50
BAC-26-650-WS-SS	30193	Impeller, stainless steel (WS models, optional)	1	600.75
BAC-16-650	45262	Seal plate, cast iron, e-coated, (WS models)	1	518.25
BAC-16-650-A-SS	45283	Seal plate, stainless steel, (WS models, optional)	1	854.25
41107	41107	Plug, #8 SAE x 1/4" FNTP, hex, with o-ring, wetseal	1	14.25
41316	41316	Air valve, 1/4" NPT, wetseal	1	17.25
BAC-7-650	40145	Seal, carbon/ceramic/Viton®	1	112.25
BAC-7SC-650	40146	Seal, silicon carbide mechanical seal (optional for non WS models)	1	237.00
BAC-7-650-WS	40143	Dual seal assembly, Type 21, .750 shaft, (WS models)	1	226.00
41108	41108	Plug, #8 SAE, hex head, with o-ring (WS models)	1	10.25
44039	44039	Bushing, #8 SAE x 1/8" FNPT (WS models)	1	35.25
50150	50150	Pressure gauge, 0-60 PSI, 1/8" NPT (WS models)	1	29.75
55851	55851	Site gauge, steel, #8 SAE, with float (WS models)	1	55.00
BAC-14-650-MAG	40297	Mounting frame, cast iron, e-coated (for MAG-D models)	1	678.00
40950	40950	Cap screw, 3/8" NC x 3/4" Hex Head	8	0.75
BAC-42	40970	Cap screw, 3/8" NC x 2" hex head, (WS models)	4	1.75
41907	41907	Cap screw, 3/8" NC x 1", socket head, stainless steel (WS models)	4	3.75
BAC-54-650	41132	Slinger	1	6.00
41943	41943	Snap ring, internal, BAC-6-650-D-SS	2	4.75
ACAL-32	30174	Snap ring, external, BAC-6-650-D-SS	1	2.25
40875	40875	Bearing, BAC-6-650-D-SS driven shaft	2	51.75
41085	41085	Key, 3/16" x 3/16" x 7/8" (for impeller)	1	1.50
BAC-6-650-D-SS	40052	Shaft, 1" driven, -D clutch keyed, stainless steel	1	307.50
BAC-6-650-SS	40053	Shaft, 1" driven, stainless steel	1	302.00
BAC-6-650-SS-WS	40047	Shaft, 1" driven, stainless steel (WS models)	1	356.25
BAC-32-650	40794	Spacer for BAC-6-650-D-SS	1	54.00
BAC-50	41080	Key, 3/16" x 3/16" x 1-1/4" (for pulley)	1	1.75
55032	55032	Barrier fluid, quart (32 oz.) (WS models)		61.50

FMC-CW-800

2" x 1-1/2" Frame Mounted Clockwise Rotation Pumps



PART NO.	EDP NO.	DESCRIPTION	REQ.	EACH
RK-FMC-CW-800	52715	Repair kit for FMC-CW-800 pump, includes "O" Ring 30009, seal 30255, and "O" Ring 73010		162.00
RK-FMCSC-CW-800	52716	Repair kit for FMC-CW-800 pump, includes "O" Ring 30009, seal 30256, and "O" Ring 73010		371.75
41120	41120	Pipe plug, 1/8" NPT, stainless steel (optional)	3	6.00
BAC-53	41110	Pipe plug, 1/8" NPT	3	0.65
ACAL-14	30160	Volute, 2" x 1 1/2", clockwise rotation, cast iron	1	492.75
45196	45196	Nut, 9/16" N.F. Hex, stainless steel	1	10.25
BACG-44-A	45191	Washer, 9/16" Lock type, stainless steel	1	50.75
ACAL-26-75	30555	Impeller, 8" diameter, with keyway	1	565.50
TYPE 21-984	30255	Seal, Type 21 mechanical seal for .984" shaft, Viton®	1	136.75
TYPE 21-984-SC	30256	Seal, Type 21 mechanical seal for .984" shaft with silicon carbon faces, Viton® (optional)	1	353.75
BACG-90M	45270	Seal cartridge for mechanical seal	1	143.25
73010	73010	"O" Ring for seal cartridge, Buna N	1	3.75
GE-54	42220	Slinger	1	5.25
ACAL-4	30009	"O" Ring for ACAL-14 volute	1	14.25
ACAL-15-MAG-D	30168	Mounting frame	1	727.50
40930	40930	Cap screw, 3/8" N.C. x 3/4" Hex head; stainless steel (optional)	8	2.75
40950	40950	Cap screw, 3/8" N.C. x 3/4" Hex head	8	0.75
BACG-33	45165	Snap ring, internal	2	4.75
ACAL-37-DRB	30179	Bearing, sealed, double row	2	174.25
ACAL-32	30174	Snap ring, external	2	2.25
ACAL-32-S-A	30176	Spacer for ACAL-6 shaft with double row bearings, length .985"	1	41.75
41079	41079	Key, 3/16" x 3/16" x 1/2" for impeller	1	1.25
41088	41088	Key, woodruff #505, for ACAL-6-SS-D shaft	1	1.75
BAC-50	41080	Key, 3/16" x 3/16" x 1 1/4", pulley side	1	1.75
ACAL-6-SS-A	30017	Shaft, stainless steel (for FMC-CW-800 with double row bearings)	1	343.00
ACAL-6-SS-D	30019	Shaft, stainless steel (for FMC-CW-800-MAG-D)	1	358.25
41472	41472	Tool, seal installation bullet	1	66.00

RP-600C and RP-600C-R 3/4" x 3/4" 6 Roller Pump



PART NO	EDP NO	DESCRIPTION	REQ	EACH
RK-RP-600	14975	Repair kit, universal, includes items 3(qty. 2), 6, and 10 (qty. 6)		62.50
14863	14863	Dust cap, cover	1	2.00
14859	14859	Bearing, sealed	2	13.75
14858	14858	Seal, FKM	2	14.25
GE-60	42230	Cap screw, 5/16" NF x 3/4"	4	0.75
14852	14852	End plate, cast iron	1	80.50
14861	14861	O-ring, body seal	1	2.00
14864	14864	Dust cap, body	1	2.00
14804	14804	Roller	6	5.00
BAC-57	41180	Set screw	1	1.00

RP-800C and RP-800C-R 3/4" x 3/4" 8 Roller Pump

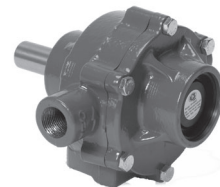

PART NO	EDP NO	DESCRIPTION	REQ	EACH
RK-RP-800	14950	Repair kit, universal, includes items 3(qty. 2), 6, and 10 (qty. 8)		87.00
14813	14813	Dust cap, cover	1	2.00
14809	14809	Bearing, sealed	2	20.25
14808	14808	Seal, FKM	2	22.50
GE-60	42230	Cap screw, 5/16" NF x 3/4"	6	0.75
14802	14802	End plate, cast iron	1	106.75
14811	14811	O-ring, body seal	1	2.00
14814	14814	Dust cap, body	1	2.00
14804	14804	Roller	8	5.00
BAC-57	41180	Set screw	1	1.00
14879	14879	Key, 1/4" x 1/4" x 1-1/2"	1	1.25

BAC-10-RP6 and BAC-10-RP8 Multispeed PTO Adapter



PART NO	EDP NO	DESCRIPTION	REQ	EACH
14902	14902	Sleeve, ball retainer	1	44.25
14903	14903	Spring	1	14.25
14904	14904	Ball, quick coupler	3	1.50
14905	14905	Set screw, 5/16"-18 cup point	1	1.00

RP-TBK Torque Bar Kit

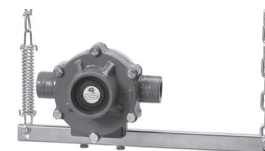

PART NO	EDP NO	DESCRIPTION	REQ	EACH
RP-TBK-87-20	15115	Chain, tensioning, double link	1	5.50
RP-TBK-5	15110	Spring, drawbar	1	7.25
RP-TBK-1	15105	Torque bar	1	66.00
42237	42237	Cap screw, 5/16"-18 x 1-3/8"	3	2.25
20730	20730	Washer, flat	1	0.60
BAC-63	41260	Nut, self-locking	1	1.00
RP-TBK-87-18	15120	Chain, torque	1	7.25

ALPHABETICAL PARTS LISTING

Part Number	EDP	Description	List Price
5AC-10	30100	VOLUTE; 1-1/4" x 1"; CW ROTATION; IRON	\$350.50
5AC-10-EC	30100E	VOLUTE; 1-1/4" x 1"; CW ROTATION; ECOAT	\$410.00
5AC-9-625	30070	BRACKET; 5/8" BORE; 4 HOLE; CAST IRON	\$240.25
6AC-12	30130	VOLUTE; 1-1/2" x 1-1/4"; CW; CAST IRON	\$381.50
7AC-14-4	30145	VOLUTE; 2" x 1-1/2"; 4 HOLE; IRON; CW	\$418.75
7AC-14-4-EC	30146	VOLUTE; 2" x 1-1/2"; 4 HOLE; IRON; CW;EC	\$478.50
7AC-14-CCW	41526	VOLUTE; 2" x 1.5"; CCW; IRON	\$418.75
7AC-14-CCW-BSP	40264	VOLUTE; 2" x 1.5" BSP; CCW; IRON	\$462.00
7AC-14-CCW-EC	40379	VOLUTE; 2" x 1.5"; CCW; ECOATED	\$478.50
7AC-14-CCW-SS	41531	VOLUTE; 2" x 1.5"; CCW; 316 SS	\$879.75
7AC-14-FLG	41530	VOLUTE; 300 x 220 FLANGED; CCW; IRON	\$523.75
7AC-14-FLG-A	41535	VOLUTE; 300 x 200; FLANGED; CCW; IRON	\$585.25
7AC-14-FLG-EC	40378	VOLUTE; 300 x 220 FLG; CCW; IRON; ECOAT	\$583.25
7AC-14-FLG-SS	41532	VOLUTE; 2" x 1.5"; FLANGED; STAINLESS STEEL	\$1,021.75
ACAL-12	30161	VOLUTE; 1-1/2" x 1-1/4"; CW ROTATION; IR	\$387.00
ACAL-12-650	30155	VOLUTE; 1-1/2" x 1-1/4"; CW ROTATION; IR	\$455.25
ACAL-12-EC	30196	VOLUTE; 1-1/2" x 1-1/4"; CW ROT; ECOAT	\$464.00
ACAL-14	30160	VOLUTE; 2" x 1-1/2"; CW ROTATION; IRON	\$492.75
ACAL-143	30045	BRACKET FOR GE-800 AND GE-1600	\$583.25
ACAL-143-EC	30044	BRACKET FOR GE-800 AND GE-1600	\$655.00
ACAL-14-EC	30151	VOLUTE; 2" x 1-1/2"; CW ROT; ECOAT IRON	\$552.25
ACAL-15-MAG-D	30168	FRAME; FOR FMC-CW-800-MAG-D	\$727.50
ACAL-16	30170	VOLUTE; 2-1/2" x 2" NPT; CW; CAST IRON	\$737.50
ACAL-16-EC	30139	VOLUTE; 2-1/2" x 2" NPT; CW; CAST IRON	\$784.00
ACAL-26-75	30555	IMPELLER; 8"DIA;CW-800; KEYWAY; IRON	\$565.50
ACAL-26-860	30558	IMPELLER; GE-860; CAST IRON; KEYED SHAFT	\$565.50
ACAL-26-860-EC	30559	IMPELLER; GE-860;ECOAT IRON; KEYED SHAFT	\$625.00
ACAL-26-TH	30047	IMPELLER; 1" UNF RH THREAD; CAST IRON	\$565.50
ACAL-28	30173	IMPELLER; 5/8" THREAD; 650 PUMP	\$404.50
ACAL-28-660	30171	IMPELLER; GE-660; 3/4" KEY SHAFT; CI	\$392.25
ACAL-28-660-EC	30195	IMPELLER; GE-660; 3/4" KEY SHAFT; ECOAT	\$452.00
ACAL-28-660-P	30556	IMPELLER; KEYWAY; THERMOPLASTIC	\$138.75
ACAL-28-EC	30553	IMPELLER FOR GE-650; ECOATED	\$474.00
ACAL-30-1600	30561	IMPELLER; IRON; 1"UNF RH THREAD	\$545.75
ACAL-30-1600-EC	30562	IMPELLER; IRON; 1"UNF RH THREAD; E-COATE	\$605.25
ACAL-32	30174	SNAP RING; EXTERNAL	\$2.25
ACAL-32-S-A	30176	SPACER FOR ACAL-6; .985" LENGTH	\$41.75
ACAL-37-DRB	30179	BEARING; SEALED; DOUBLE ROW	\$174.25
ACAL-4	30009	O-RING; VOLUTE SEAL	\$14.25
ACAL-55	30185	BRACKET FOR GE-650	\$595.50
ACAL-55-EC	30554	BRACKET FOR GE-650	\$655.00
ACAL-66	30186	BRACKET; GE-660 KEYED SHAFT	\$375.00
ACAL-66-EC	30197	BRACKET; GE-660 KEYED SHAFT; ECOAT	\$434.50
ACAL-6-SS-A	30017	SHAFT; SS STEEL; (for FMC-CW-800-DRB)	\$343.00
ACAL-6-SS-D	30019	SHAFT; SS STEEL; (for FMC-CW-800-MAG-D)	\$358.25
ACAL-7-SS	30018	SHAFT SLEEVE FOR GE-800; SS STEEL	\$231.50
ACAL-88	30187	BRACKET; GE-860	\$535.75
ACAL-88-EC	30199	BRACKET; GE-860; ECOAT	\$595.50
BAC-10-175-20SP	40180	SHAFT ASSY; 1.75"-20 SPLINE; BAC-11-175	\$534.50
BAC-10-21SP	40220	SHAFT ASSY; 1.375"-21 SPLINE; BAC-11 COL	\$507.00
BAC-10-6SP	40200	SHAFT ASSY; 1.375"-6 SPLINE	\$396.75
BAC-10-6SPQC	40210	SHAFT ASSY; 1.375"-6 SPLINE; QUICK COUPL	\$402.50
BAC-10-RP6-QC	14880	QUICK COUPLER ASSY; 6 ROLLER; 5/8" X 6 AND 21 SPLINE	\$67.25
BAC-10-RP8-QC	14830	QUICK COUPLER ASSY; 8 ROLLER; 25MM X 6 AND 21 SPLINE	\$71.75
BAC-10-S	40190	SHAFT; 1" STUB	\$396.75
BAC-11	40235	COLLAR FOR BAC-10-21SP; 1.375" SHAFT	\$141.25
BAC-11-1	40237	CAP SCREW; 5/16"NF X 1" SOCKET HEAD	\$1.25
BAC-11-175	40236	COLLAR FOR BAC-10-20SP; 1.75" SHAFT	\$192.00
BAC-12	40250	VOLUTE; 1-1/4" x 1"; CAST IRON	\$307.50
BAC-12-125	30147	VOLUTE; 1-1/4" x 1"; CAST IRON	\$376.00
BAC-12-150	40255	VOLUTE; 1-1/2" x 1-1/4"; CAST IRON	\$381.50
BAC-12-150-BSP	40262	VOLUTE; 1-1/2" x 1-1/4" BSP; CAST IRON	\$433.25
BAC-12-150-EC	40365	VOLUTE; 1-1/2" x 1-1/4"; ECOATED IRON	\$452.00
BAC-12-150-FLG	40257	VOLUTE; FLANGED; CAST IRON	\$455.25
BAC-12-150-FLG-EC	40266	VOLUTE; FLANGED; CAST IRON; ECOATED	\$514.75
BAC-12-150-SP	40254	VOLUTE; 1.5"x 1.25"; SELF-PRIMING; CAST	\$952.50
BAC-12-150-SS	40249	VOLUTE; FLANGED; 316 STAINLESS STEEL	\$1,016.25
BAC-12-255-FLG	30149	VOLUTE; 1-1/2" x 1-1/4"; FLANGED; E-COATED	\$583.25
BAC-12-650	30163	VOLUTE;1-1/2" x 1-1/4" NPT; CCW ROTATION	\$469.50
BAC-12-650-BSP	30153	VOLUTE;1-1/2" x 1-1/4" BSP; CCW ROTATION	\$505.00
BAC-12-650-FLG	30159	VOLUTE; 1-1/2" x 1-1/4"; CCW ; FLANGED	\$567.75
BAC-12-650-FLG-NPP	30144	VOLUTE; 1-1/2" x 1-1/4"; CCW ; FLANGED	\$567.75
BAC-12-650-FLG-SS	30156	VOLUTE; 1-1/2" x 1-1/4"; FLANGED; STAINLESS STEEL	\$1,079.25
BAC-12-750-FLG	30158	VOLUTE;750 MODELS ; CCW ; FLANGED; CI	\$737.50
BAC-12-750-FLG-NPP	30148	VOLUTE;750 MODELS ; CCW ; FLANGED; CI	\$737.75
BAC-12-750-SS	30152	VOLUTE;750 MODELS ; CCW ; FLANGED; SS	\$1,200.50
BAC-12-855F	30154	VOLUTE; 300 X 300 FLG; CCW ROTATION	\$2,385.50
BAC-12-BSP	40261	VOLUTE; 1-1/4" x 1" BSP; CAST IRON	\$340.50
BAC-12-CW	40253	VOLUTE; 1-1/4" x 1"; CI; CW ROTATION	\$307.50
BAC-12-CW-EC	40265	VOLUTE; 1-1/4" x 1"; CI; CW ROTATION; ECOAT	\$367.00
BAC-12-EC	40368	VOLUTE; 1-1/4" x 1"; CAST IRON; E-COAT	\$367.00
BAC-13	40270	IDLER ARM	\$108.25
BAC-14-150-F	40306	FRAME; 150 SERIES	\$401.25
BAC-14-150-F-EC	40371	FRAME; ECOAT; 150 SERIES	\$460.75
BAC-14-150-HYD	40305	FRAME FOR HYD MOTOR; 150 SERIES	\$475.00
BAC-14-150-HYD-300	40304	FRAME FOR 300 HYD MOTOR; 150 SERIES	\$505.00
BAC-14-150-HYD-300A	40328	FRAME FOR 300A HYD MOTOR; 150 PUMP	\$517.25
BAC-14-150-HYD-300A-EC	40369	FRAME FOR 300A HYD MOTOR; ECOAT;150 PUMP	\$577.75
BAC-14-150-HYD-300A-SS	40345	FRAME FOR 300A HYD MOTOR; 150 PUMP	\$1,079.25
BAC-14-150-HYD-EC	40366	FRAME FOR HYD MOTOR; ECOAT; 150 SERIES	\$534.50
BAC-14-150-HYD-SS	40319	FRAME FOR HYD MOTOR; 150 SERIES; 316 SS	\$1,067.00
BAC-14-150-MAG	40307	FRAME; 150 SERIES; FOR MAG CLUTCH	\$443.00

Part Number	EDP	Description	List Price
BAC-14-150-MAG-D	40381	FRAME; 150 SERIES; W/ MOUNT FOR MAG-D	\$621.75
BAC-14-150-MIA	40308	FRAME FOR IDLER ARM; 150 SERIES	\$401.25
BAC-14-150-MIA-EC	40380	FRAME FOR IDLER ARM; ECOAT; 150 SERIES	\$460.75
BAC-14-155-HYD-SS	40348	FRAME FOR HYD MOTOR; 155 SERIES; 316 SS	\$1,067.00
BAC-14-205-HYD	40338	FRAME; 300A SERIES MOTOR; 203 BEARING	\$448.75
BAC-14-205-HYD-EC	40375	FRAME; 300A MOTOR; 203 BEARING; E-COAT	\$509.25
BAC-14-205-HYD-SS	40346	FRAME; 300A SERIES MOTOR; STAINLESS STEE	\$1,079.25
BAC-14-5-HYD	40288	FRAME FOR PRO5 SERIES PUMPS	\$434.50
BAC-14-650-HYD	40325	FRAME FOR FMC-650-HYD	\$739.75
BAC-14-650-HYD-LIN	40343	FRAME; BAC-14-650-HYD-LIN	\$798.25
BAC-14-650-HYD-WS	40289	FRAME FOR FMCWS-650-HYD	\$856.50
BAC-14-650-LIN	40349	FRAME; FOR FMC-650FS-MAG-D	\$702.00
BAC-14-650-MAG	40297	FRAME FOR 650-MAG-D CLUTCH	\$678.00
BAC-14-650-MAG-WS	40287	FRAME FOR FMCWS-650-MAG-D CLUTCH	\$678.00
BAC-14-750-HYD	40333	FRAME; FMC-750-HYD; CI	\$923.75
BAC-14-750-HYD-A	40361	FRAME; FMC-750-HYD; CI ALTERNATE DRILL	\$923.75
BAC-14-75-HYD	40293	FRAME FOR HYD MOTOR; 75 SERIES	\$314.00
BAC-14-855-HYD	40294	FRAME; FMC-855-HYD	\$1,878.50
BAC-14-F	40310	FRAME	\$319.75
BAC-14-F-A	40326	FRAME; PROG AG	\$370.00
BAC-14-F-EC	40398	FRAME; EC	\$369.25
BAC-14-HYD	40300	FRAME FOR 200 SERIES HYD MOTOR	\$394.75
BAC-14-HYD-300	40301	FRAME FOR 300 SERIES HYD MOTOR	\$418.75
BAC-14-HYD-300A	40314	FRAME; 300A SERIES MOTOR	\$431.00
BAC-14-HYD-300A-BLK	40314P	FRAME; 300A SERIES MOTOR; BLACK	\$431.00
BAC-14-HYD-300A-EC	40376	FRAME; ECOAT; 300A SERIES MOTOR	\$491.75
BAC-14-HYD-300A-LIN	40337	FRAME; 300A SERIES; SS LINER	\$505.00
BAC-14-HYD-EC	40367	FRAME FOR 200 SERIES HYD MOTOR; E-COAT	\$453.25
BAC-14-LIN	40336	BRACKET FACE; SS STAMPED LINER	\$170.75
BAC-14-MAG	40285	FRAME FOR MAG CLUTCH	\$389.25
BAC-14-MIA	40290	FRAME FOR IDLER ARM	\$338.50
BAC-14-MIA-EC	40286	FRAME FOR IDLER ARM; E-COATED	\$387.00
BAC-14X-205-F	40383	FRAME FOR X SERIES PUMP	\$441.00
BAC-14X-205-F-A	40386	FRAME FOR X SERIES PUMP	\$448.75
BAC-14X3-MIA	40316	FRAME; X SERIES; MACHINED FOR IDLER	\$448.75
BAC-14X-F	40309	FRAME FOR X SERIES PUMP	\$425.50
BAC-14X-F-A	40312	FRAME FOR X SERIES PUMP	\$474.00
BAC-14X-MIA	40313	FRAME; X SERIES; MACHINED FOR IDLER	\$474.00
BAC-14X-MIA-LIN	40296	FRAME; X SERIES; MACHINED FOR IDLER	\$490.50
BAC-15	40340	HOUSING FOR DRIVE SHAFT; PTOC	\$252.50
BAC-15-150-A-6SP	40354	HOUSING ASSY; 150 SRS; 6 SPLINE SHAFT	\$1,113.25
BAC-15-150-A-M	40357	HOUSING ASSY; 150 SRS; 21 SPLINE	\$1,217.00
BAC-15-150-A-QC	40355	HOUSING ASSY; 150 SRS; 6 SPLINE QC SHFT	\$1,119.00
BAC-15-150-B-600	40358	HOUSING ASSY; 150 SRS; 1" STUB; 600 RPM	\$1,222.50
BAC-15-150-B-M	40359	HOUSING ASSY; 150 SRS; 1" STUB;1000RPM	\$1,216.00
BAC-15-A-175	40353	HOUSING ASSY; 20 SPLINE SHAFT	\$1,244.50
BAC-15-A-6SP	40351	HOUSING ASSY; 6 SPLINE SHAFT	\$1,094.50
BAC-15-A-M	40360	HOUSING ASSY; 21 SPLINE SHAFT	\$1,192.50
BAC-15-AM-6SP	40362	HOUSING ASSY; 6 SP SHAFT; 1000 RPM	\$1,082.25
BAC-15-AM-6SPOC	40363	HOUSING ASSY; 6 SPL QC SHAFT; 1000 RPM	\$1,088.00
BAC-15-A-QC	40352	HOUSING ASSY; 6 SPLINE QC SHAFT	\$1,100.25
BAC-15-B	40370	HOUSING WITH MOUNTING FEET	\$361.75
BAC-15-B-A-600	40373	HOUSING ASSY; 1" STUB; 600 RPM	\$1,203.75
BAC-15-B-LESS PULLEY	40364	HOUSING ASSY; LESS PULLEY	\$877.50
BAC-15-B-M	40372	HOUSING ASSY; 1" STUB; 1000 RPM	\$1,301.75
BAC-15-PIN	40799	ALIGNMENT PIN FOR PTOC PUMPS	\$1.25
BAC-16	45285	SEAL PLATE; NEXT GEN; E-COATED; CI	\$512.75
BAC-16-650	45262	OBSOLETE; SEAL PLATE; FMCWS-650; E-COATED; CI	\$518.25
BAC-16-650-A	45282	SEAL PLATE; FMCWS-650; E-COATED; CI	\$518.25
BAC-16-650-A-SS	45283	SEAL PLATE; FMCWS-650; STAINLESS STEEL	\$854.25
BAC-16-650-LIN	40344	LINER; SEAL RETAINER; 650SS	\$433.25
BAC-16-750	45264	SEAL PLATE; FMC-750-HYD; CAST IRON	\$551.25
BAC-16-750-SS	45259	SEAL PLATE; FMC-750-HYD; STAINLESS STEEL	\$909.50
BAC-16-855	45263	SEAL PLATE; FMC-855-HYD; CAST IRON	\$1,090.25
BAC-16-RES	45269	RESERVOIR; END CAP; CAST IRON	\$392.25
BAC-23-A	40391	NUT; 3/8" NF FLEX LOCK; CAD PLATED	\$2.75
BAC-23-A-SS	40392	NUT; 3/8" NF HEX; STAINLESS STEEL	\$10.75
BAC-23-B-SS	40393	NUT; 3/8" NF HEX; STAINLESS STEEL	\$1.25
BAC-24-B-SS	42702	WASHER; 3/8" SS VIBRATION PROOF	\$8.25
BAC-24-HYD-SS	40400	WASHER; 3/8"; SS	\$1.75
BAC-25	40425	KEY FOR 2" IMPELLER; 1/8" x 1/8" x .825"	\$1.25
BAC-26-125-P	40444	IMPELLER; KEYWAY; THERMOPLASTIC	\$128.00
BAC-26-150-CI	40445	IMPELLER; KEYWAY; CAST IRON	\$266.75
BAC-26-150-CI-EC	40384	IMPELLER; KEYWAY; CAST IRON; E-COAT	\$326.25
BAC-26-150-P	40446	IMPELLER; KEYWAY; THERMOPLASTIC	\$108.25
BAC-26-150-PI	40448	IMPELLER; KEYWAY; POLYPROPYLENE	\$113.50
BAC-26-150-SS	40449	IMPELLER; 5.5"DIA; CCW; 1.5" PUMP; 316 SS	\$426.75
BAC-26-155-P	40453	IMPELLER; KEYWAY; THERMOPLASTIC	\$138.75
BAC-26-200-CI	40433	IMPELLER; 5.5"DIA; CCW; KEYWAY; 2" PUMP	\$326.25
BAC-26-200-P	40434	IMPELLER; 5.5"DIA; CCW; KEYWAY; PLASTIC	\$156.50
BAC-26-200-SS	40436	IMPELLER; 5.5"DIA; CCW; 2" PUMP; 316 SS	\$445.50
BAC-26-255-P	40454	IMPELLER; KEYWAY; THERMOPLASTIC	\$138.75
BAC-26-650	30169	IMPELLER; FMC-650; 3/4" KEY SHAFT; CI	\$317.50
BAC-26-650-SS	30191	IMPELLER; FMC-650; 3/4" KEY SHAFT; SS	\$555.50
BAC-26-650-WS	30192	IMPELLER; FMCWS-650; 3/4" KEY; E-COAT	\$372.50
BAC-26-650-WS-SS	30193	IMPELLER; FMCWS-650; 3/4" KEY; 316 SS	\$600.75
BAC-26-750-CI	30182	IMPELLER; FMC-750; CI	\$565.50
BAC-26-750-SS	30189	IMPELLER; FMC-750; STAINLESS STEEL	\$630.50
BAC-26-855-CI	30198	IMPELLER; FMC-855-HYD; CI	\$1,083.75
BAC-26-CI	40432	IMPELLER; CAST IRON; LH THREAD	\$244.75
BAC-26-CW-150-CI	41515	IMPELLER; 5.5"DIA; RH THREAD; IRON	\$244.75
BAC-26-CW-150-P	41510	IMPELLER; 5.5"DIA; RH THREAD; PLASTIC	\$108.25

Part Number	EDP	Description	List Price
BAC-26-CW-200-CI	41520	IMPELLER; 5.125"DIA; RH THREAD; IRON	\$326.25
BAC-26-CW-200-P	41523	IMPELLER; 5.5"DIA; RH THREAD; PLASTIC	\$162.00
BAC-26-HYD-200-CI	41525	IMPELLER; 5.5"DIA; KW; CI; (OBS.1/99)	\$326.25
BAC-26-HYD-CI	40442	IMPELLER; KEYWAY; CAST IRON	\$251.50
BAC-26-HYD-CI-EC	40377	IMPELLER; KEYWAY; CAST IRON; E-COAT	\$315.50
BAC-26-HYD-VALOX	40440	IMPELLER; KEYWAY; VALOX	\$108.25
BAC-26-VALOX	40430	IMPELLER; VALOX; LEFT HAND THREAD	\$108.25
BAC-27	40520	DUST COVER FOR PTOC & PTOC-150	\$12.75
BAC-28-10	40610	BELT; 40"; 10 GROOVE (FOR PTOC-600)	\$68.50
BAC-28-10-150	40611	BELT; 44"; 10 GROOVE (FOR PTOC-150-600)	\$75.00
BAC-28-10-M	40620	BELT; 31"; 10 GROOVE (FOR PTOC-1000)	\$69.50
BAC-28-10M-150	40621	BELT; 36"; 10 GROOVE (FOR PTOC-150-1000)	\$76.25
BAC-29-10-1.35	40675	PULLEY; 1.35"PD x 5/8" BORE; 10 GROOVE	\$99.25
BAC-29-10-1.5	40680	PULLEY; 1.5"PD x 5/8" BORE; 10 GROOVE	\$99.25
BAC-29-10-1.7	40681	PULLEY; 1.7"PD x 5/8" BORE; 10 GROOVE	\$99.25
BAC-30-10	40740	PULLEY; 10.6"PD x 2" BORE; 10 GROOVE	\$326.25
BAC-30-10-150	40741	PULLEY; 11.6"PD x 2" BORE; 10 GROOVE	\$345.00
BAC-30-10-M	40750	PULLEY; 6.375"PD x 2" BORE; 10 GROOVE	\$314.00
BAC-30-10-M-150	40751	PULLEY; 7.9"PD x 2" BORE; 10 GROOVE	\$338.50
BAC-30-175	40745	PULLEY; 6.375"PD x 2.375"BORE;10GROOVE	\$338.50
BAC-30-175-150	40746	PULLEY; 7.9"PD x 2.375"BORE; 10 GROOVE	\$369.25
BAC-31-1	40781	BEARING; BAC-10 SHAFT	\$59.50
BAC-31-RETRO	40782	RETROFIT KIT; BAC-31 TO BAC-31-1	\$202.50
BAC-32	40790	SNAP RING FOR BAC-6 SHAFT	\$0.75
BAC-32-650	40794	SPACER FOR BAC-6-650-SS SHAFT	\$54.00
BAC-32-650-WS	40802	SPACER FOR BAC-6-650-HYD-SS-WS SHAFT	\$48.50
BAC-32-750	40793	SPACER;BAC-6-750-HYD-SS-WS SHAFT	\$56.25
BAC-32-S	40795	SPACER FOR BAC-6 SHAFT	\$7.00
BAC-32X	40792	SNAP RING FOR BAC-6X SHAFT	\$1.25
BAC-32X-S	40796	SPACER FOR BAC-6X SHAFT	\$37.50
BAC-33	40810	SNAP RING; INTERNAL; BAC-14 FRAME	\$2.25
BAC-33X	40812	SNAP RING; INTERNAL; BAC-14X FRAME	\$3.75
BAC-34	40830	SNAP RING; INTERNAL; BAC-15 HOUSING	\$6.00
BAC-35	40840	SNAP RING; EXTERNAL; BAC-10 SHAFT	\$1.25
BAC-36	40850	SNAP RING; EXTERNAL; BAC-13 IDLER	\$2.25
BAC-36X	40855	SNAP RING; EXTENAL; X SERIES PUMP	\$3.75
BAC-37	40870	BEARING; BAC-6 DRIVEN SHAFT	\$23.25
BAC-37X	40872	BEARING; BAC-6X DRIVEN SHAFT	\$34.75
BAC-38-1	40905	SPACER FOR BAC-10 DRIVE SHAFT. L=1.5"	\$44.75
BAC-38-R	40907	SPACER FOR BAC-10 RETRO KIT; L=.31"	\$37.50
BAC-4	40010	GASKET; 4 HOLE	\$4.75
BAC-40	40940	SET SCREW; 3/8" NC SLOTTED	\$1.25
BAC-4-150	40015	O-RING; VOLUTE SEAL	\$9.25
BAC-4-150-E	40016	O-RING; VOLUTE SEAL; EPDM	\$10.75
BAC-42	40970	CAP SCREW; HEX HD 3/8"-16 X 2" GRADE 5	\$1.75
BAC-43	40980	WASHER; 5/16" FLAT	\$0.60
BAC-44	40990	3/8" LOCK WASHER	\$0.60
BAC-45	41010	NUT; 3/8" NC HEX	\$0.60
BAC-46	41020	SPACER; 5/8"	\$35.25
BAC-47	41040	CAP SCREW; 5/8" NC x 2-1/4" HEX HEAD	\$9.50
BAC-49	41070	RETAINER RING	\$0.75
BAC-4A	40005	O-RING FOR BAC-12 VOLUTE	\$9.25
BAC-4A-E	40006	O-RING FOR BAC-12 VOLUTE; EDPM	\$10.75
BAC-5	40030	SPRING; TORSION; FOR PTOC IDLER ARM	\$26.75
BAC-50	41080	KEY; 3/16" x 3/16" x 1-1/4"	\$1.75
BAC-51	41090	KEY; 3/8" x 1/2" x 1-1/2"; PTO DRIVE SHA	\$6.75
BAC-5-150	40035	SPRING; TORSION; FOR PTOC-150 IDLER	\$30.50
BAC-52	41100	1/4" COLD SHUT; TORQUE CHAIN ANCHOR	\$5.00
BAC-53	41110	PIPE PLUG; 1/8" NPT; HEX HEAD	\$0.65
BAC-53-P	41109	PIPE PLUG; 1/8" NPT; PLASTIC	\$2.25
BAC-54	41130	SLINGER; 1" OD X 9/16" ID X .125" THK	\$2.25
BAC-54-650	41132	SLINGER; 1.5" OD X 7/8" ID X .125" THK	\$6.00
BAC-55	41140	IDLER BEARING AND ROLLER ASSY	\$77.25
BAC-55-A	41150	IDLER ARM AND ROLLER ASSY	\$231.00
BAC-57	41180	SET SCREW; 5/16" NC x 5/16" ALLEN HEAD	\$1.00
BAC-58	41190	ZERK FITTING; 1/4" DRIVE-IN	\$3.75
BAC-6-125-HYD-SS	41582	SHAFT; 17MM DIA; KEYWAY; TANG SLOT; SS	\$169.75
BAC-6-125-HYD-SS-WS	41581	SHAFT; 17MM DIA; KEYWAY; TANG SLOT; SS	\$233.75
BAC-6-125-SS	41585	SHAFT; 17MM DIA; KEYWAY; BELT DRIVE; SS	\$176.25
BAC-6-150/200-SS	40056	SHAFT; 5/8"DIA; KEYWAY; STAINLESS	\$157.50
BAC-6-150-D-SS	40076	SHAFT; 5/8"DIA; .5" KW; 5/16" HOLE; SS	\$200.75
BAC-6-155-HYD-SS	40072	SHAFT; 17MM DIA; KEYWAY; TANG SLOT; SS	\$263.50
BAC-6-200-D-SS	40058	SHAFT; 5/8"DIA; .922" KW; 5/16" HOLE;SS	\$182.00
BAC-6-200-SS	40057	SHAFT; 5/8"DIA; KEYWAY; FOR 2" CCW; SS	\$150.00
BAC-6-205-HYD-SS	40068	SHAFT; 17MM DIA; KEYWAY; TANG SLOT; SS	\$239.25
BAC-6-255-HYD-SS	41584	SHAFT; 17MM DIA; KEYWAY; TANG SLOT; SS	\$239.25
BAC-63	41260	NUT; 5/16" NC SELF-LOCKING	\$1.00
BAC-6-650-D-SS	40052	SHAFT; .984 DIA; TAPERED; SS	\$307.50
BAC-6-650-D-SS-WS	40045	SHAFT; .984 DIA; TAPERED; SS	\$338.50
BAC-6-650-HYD-SS	40051	SHAFT; 1.13" DIA; 11 TOOTH SPLINE ; SS	\$400.25
BAC-6-650-HYD-SS-WS	40049	SHAFT; 1" DIA; 650 WS; SPLINED; SS	\$460.75
BAC-6-650-SS	40053	SHAFT; .984 DIA; SS	\$302.00
BAC-6-650-SS-WS	40047	SHAFT; .984 DIA; SS; WET SEAL	\$356.25
BAC-6-750-HYD-SS-WS	40066	SHAFT; KEYWAY; 750 WS; SPLINED; SS	\$545.75
BAC-6-750-SS-WS	40067	SHAFT; KEYWAY; SS	\$446.50
BAC-6-75-HYD-SS	40048	SHAFT; 5/8"DIA; TANG DRIVE	\$150.00
BAC-6-75-SS	40046	SHAFT; 5/8"DIA; BELT DRIVE	\$150.00
BAC-6-850-HYD-SS	40065	SHAFT; 1-1/8"DIA; KEYWAY; SS	\$640.50
BAC-6-CW-D-SS	41501	SHAFT; 5/8"DIA; RH THREAD; 5/16" HOLE;SS	\$194.00
BAC-6-CW-SS	41500	SHAFT; 5/8"DIA; RH FINE THREAD; SS	\$176.25
BAC-6-D-SS	40071	SHAFT; 5/8"DIA; LH THREAD; 5/16" HOLE;SS	\$194.00
BAC-6-HYD-200-SS	40063	SHAFT; 5/8"DIA; KEYWAY; TANG SLOT; SS	\$157.50

Part Number	EDP	Description	List Price
BAC-6-HYD-SS	40061	SHAFT; 5/8"DIA; KEYWAY; TANG SLOT; SS	\$157.50
BAC-6-SP-HYD-SS	40077	SHAFT; TANSFER PUMP; TANG DRIVE	\$157.50
BAC-6-SS	40070	SHAFT; 5/8"DIA; LH COURSE THREAD; SS	\$160.00
BAC-6X-200-D-SS	40059	SHAFT; 5/8"DIA; .922" KW; 5/16" HOLE;SS	\$275.50
BAC-6X-200-SS	40054	SHAFT; 3/4"DIA; .922" KW; SS	\$270.25
BAC-6X-205-CW-SS	41516	SHAFT; 3/4"DIA; RH FINE THREAD; SS	\$270.25
BAC-6X-205-SS	41524	SHAFT; 3/4"DIA; KEYED; SS	\$270.25
BAC-6X-CW-D-SS	41507	SHAFT; 5/8"DIA; RH THREAD; MAG-D; SS	\$270.25
BAC-6X-CW-SS	41504	SHAFT; 3/4"DIA; RH FINE THREAD; SS	\$270.25
BAC-6X-D-SS	41517	SHAFT; 5/8"DIA; LH THREAD; MAG-D; SS	\$270.25
BAC-6X-SS	41509	SHAFT; 3/4"DIA; LH COARSE THREAD; SS	\$270.25
BAC-70	41317	FITTING; 1/8"NPT; RELIEF FOR FMCL PUMPS	\$7.25
BAC-75-200-TLS	40153	SEAL ASSY; 200 SER HYD MOTOR; TEFLON LIP	\$56.25
BAC-75-300-TLS	40154	SEAL ASSY;300 SER HYD MOTOR; TEFLON LIP	\$99.25
BAC-75-HYD-202	41368	MOTOR; 2 GPM HYD	\$809.00
BAC-75-HYD-202N	41332	MOTOR; 2 GPM HYD	\$789.25
BAC-75-HYD-203	41367	MOTOR; 3 GPM HYD	\$809.00
BAC-75-HYD-203-8SAE-CD	41339	MOTOR; 3 GPM HYD; 8 SAE; CD	\$818.00
BAC-75-HYD-203N	41333	MOTOR; 3 GPM HYD	\$789.25
BAC-75-HYD-203N5-CD	41326	MOTOR; 3 GPM HYD; 8 SAE; CD; BLACK	\$818.00
BAC-75-HYD-203N5-CD-BLK	41326P	OBS; MOTOR; 3 GPM HYD; 8 SAE; CD	\$818.00
BAC-75-HYD-204	41370	MOTOR; 4 GPM HYD	\$742.00
BAC-75-HYD-204N	41433	MOTOR; 4 GPM HYD	\$723.00
BAC-75-HYD-204N-CD	41338	MOTOR; 4 GPM HYD; 8SAE; CD	\$789.25
BAC-75-HYD-204-PRO5	41322	MOTOR; 4 GPM HYD	\$816.00
BAC-75-HYD-204R	41437	MOTOR; 4 GPM HYD; REVERSE ROTATION	\$789.25
BAC-75-HYD-206	41372	MOTOR; 7 GPM HYD	\$742.00
BAC-75-HYD-206-CD	41377	MOTOR; 7 GPM HYD; CASE DRAIN; W FITTINGS	\$789.25
BAC-75-HYD-206N	41397	MOTOR; 7 GPM HYD	\$723.00
BAC-75-HYD-206N-CD	41398	MOTOR; 7 GPM HYD; CASE DRAIN	\$801.25
BAC-75-HYD-206P	41321	MOTOR; 206-PWM; LESS MANIFOLD	\$723.00
BAC-75-HYD-206-PRO5	41329	MOTOR; 7 GPM HYD	\$816.00
BAC-75-HYD-206-PRO5-P	41319	MOTOR; 206N5-PWM; LESS MANIFOLD	\$737.50
BAC-75-HYD-206-PRO5-PWM	41290	MOTOR; 6.5 GPM HYD; PRO 5; W/ PWM VALVE	\$1,953.50
BAC-75-HYD-206-PWM	41324	MOTOR; 6.5 GPM HYD; W/ PWM VALVE	\$1,953.50
BAC-75-HYD-206R	41438	MOTOR; 6 GPM HYD; REVERSE ROTATION	\$771.75
BAC-75-HYD-206R-P	41313	MOTOR; 206R-PWM; LESS MANIFOLD	\$723.00
BAC-75-HYD-206R-PWM	41314	MOTOR; 6.5 GPM HYD; W/ PWM VALVE	\$1,990.75
BAC-75-HYD-210	41375	MOTOR; 10 GPM HYD	\$785.00
BAC-75-HYD-210N	41434	MOTOR; 10 GPM HYD	\$764.00
BAC-75-HYD-210N-CD	41439	MOTOR; 10 GPM HYD; CASE DRAIN	\$824.75
BAC-75-HYD-304	41381	MOTOR; 11 GPM HYD; N SERIES	\$1,114.50
BAC-75-HYD-304A-12SAE	41426	MOTOR; 11 GPM HYD; #12 SAE PORTS	\$1,114.50
BAC-75-HYD-304N	41343	MOTOR; 11 GPM HYD; SAE PORTS; N SERIES	\$1,100.25
BAC-75-HYD-304N-CD	41335	MOTOR; 11 GPM HYD; SAE PORTS; N SERIES	\$1,162.00
BAC-75-HYD-304P	41328	MOTOR; 304-PWM; LESS MANIFOLD	\$1,100.25
BAC-75-HYD-304-PWM	41348	MOTOR; 11 GPM HYD; W/ PWM VALVE	\$2,289.50
BAC-75-HYD-304S	41342	MOTOR; 11 GPM HYD; SAE SIDE PORTS	\$967.00
BAC-75-HYD-305-12SAE	41385	MOTOR; 15 GPM HYD; #12 SAE PORTS	\$1,128.00
BAC-75-HYD-306	41312	MOTOR; 16.5 GPM HYD; N SERIES	\$1,114.50
BAC-75-HYD-306A-12SAE	41345	MOTOR; 16.5 GPM HYD; #12 SAE PORTS	\$1,128.00
BAC-75-HYD-306N	41318	MOTOR; 16.5 GPM HYD; N SERIES	\$1,100.25
BAC-75-HYD-307	41382	MOTOR; 19 GPM HYD; #12 SAE PORTS	\$1,128.00
BAC-75-HYD-307A-CD	41386	MOTOR;18 GPM; #12 PORTS; #6 CASE DRAIN	\$1,162.00
BAC-75-HYD-307B-CD	41334	MOTOR;18 GPM; #12 PORTS; #6 CASE DRAIN	\$1,162.00
BAC-75-HYD-310	41378	MOTOR; 16 GPM HYD; 1/2 NPT; N SERIES	\$1,169.75
BAC-75-HYD-310N	41344	MOTOR; HYD; SAE END PORTS	\$1,169.75
BAC-75-HYD-M16	41359	MOTOR; HYDRAULIC; GEAR	\$1,175.25
BAC-75-HYD-M16-CD	41358	MOTOR; HYDRAULIC; GEAR; CASE DRAIN	\$1,152.00
BAC-75-HYD-M16-CDE	41349	OBS; MOTOR; HYDRAULIC; CASE DRAIN; END PORTS	\$1,157.50
BAC-75-HYD-M16-PWM	41327	MOTOR; HYDRAULIC; GEAR; 16 GPM PWM	\$2,649.25
BAC-75-HYD-M22	41355	MOTOR; HYDRAULIC; GEAR; 18 GPM	\$1,193.00
BAC-75-HYD-M22-CD	41353	MOTOR; HYDRAULIC; GEAR;18 GPM CASE DRAIN	\$1,203.75
BAC-75-HYD-M22-PWM	41336	MOTOR; HYDRAULIC; GEAR; 18 GPM PWM	\$3,063.50
BAC-75-HYD-M25	41356	MOTOR; HYDRAULIC; GEAR; 20 GPM	\$1,216.00
BAC-75-HYD-M25-CD	41352	MOTOR; HYDRAULIC; GEAR;20 GPM CASE DRAIN	\$1,227.00
BAC-75-HYD-M30	41357	MOTOR; HYDRAULIC; GEAR	\$1,240.25
BAC-75-M-FKM	40164	SEAL ASSY; M SERIES HYD MOTOR;FKM(VITON)	\$73.75
BAC-7-650	40145	SEAL; 3/4" SHAFT; VITON/CARBON/CERAMIC	\$112.25
BAC-7-650B	40144	SEAL; 3/4" SHAFT; BUNA/CARBON/CERAMIC	\$101.50
BAC-7-650-WS	40143	SEAL; 3/4" SHAFT; DOUBLE SEAL	\$226.00
BAC-7-660V	30225	SEAL; TYPE 6A-3/4; VITON; O-RING OD	\$71.75
BAC-76-HYD	41380	COUPLING FOR HYD MOTOR	\$34.00
BAC-7-750V	40147	SEAL ASSY; TYPE 21; DUAL .875 ; VITON	\$260.25
BAC-7-75E	42732	SEAL; 5/8" TYPE 68; EPR; FOR GE-75	\$136.50
BAC-7-75V	42730	SEAL; 5/8" TYPE 68; VITON; FOR GE-75	\$57.25
BAC-78-10SAE	41442	REVERSE CHECK ASSY; #10SAE X 1/2" NPT	\$36.50
BAC-78-10X10SAE	41467	REVERSE CHECK ASSY; #10SAE X #10SAE	\$41.75
BAC-78-10X8SAE	41462	REVERSE CHECK ASSY; #8 X #10 SAE	\$39.75
BAC-7-850V	40148	SEAL ASSY; TYPE 21; DUAL 1.250; VITON	\$369.25
BAC-78-8ORFSX8SAE	41463	REVERSE CHECK ASSY; #8 SAE X #8 ORFS	\$151.75
BAC-78-8SAE	41441	REVERSE CHECK ASSY; #8 SAE X 1/2" NPT	\$34.00
BAC-79-204-3/8" NPT	41390	ORIFICE; 3/8" NPT MALE x 3/8" NPT FEMALE	\$35.25
BAC-79-204-8SAE	41393	ORIFICE; #8SAE x #8SAE	\$47.25
BAC-79-206/210-3/4ORB	41415	ORIFICE; 3/8"NPT x 3/4"-16ORB	\$47.25
BAC-79-206/210-3/8" NPT	41395	ORIFICE; 3/8" NPT MALE x 3/8" NPT FEMALE	\$35.25
BAC-79-206/210-8SAE	41394	ORIFICE; #8 SAE x #8SAE WITH O-RING	\$47.25
BAC-79-304-1/2NPT	41399	ORIFICE; 1/2" NPT MALE x 1/2" NPT FEMALE	\$47.25
BAC-79-5	41457	ORIFICE; RESTRICTOR INSERT; .078	\$13.50
BAC-79-7	41456	ORIFICE; RESTRICTOR INSERT; .109	\$13.50
BAC-79-8	41447	ORIFICE; RESTRICTOR INSERT; .125	\$13.50
BAC-7B	40110	SEAL; 5/8" SHAFT; BUNA N	\$66.00

Part Number	EDP	Description	List Price
BAC-7CSC-650-WS	40131	SEAL; 3/4" SHAFT; DOUBLE SEAL	\$286.50
BAC-75C	40152	SEAL ASSY; 5/8"; VITON/SILICON/CARBIDE	\$201.75
BAC-75C-205V	40149	SEAL ASSY; 5/8" SHAFT; VITON/SC; 205 PUMP	\$201.75
BAC-75C-650	40146	SEAL ASSY; 3/4" SHAFT; VITON/SILICON CAR	\$237.00
BAC-75C-660V	30226	SEAL ASSY; TYPE 6A-3/4; SC/SC; O-RING OD	\$227.00
BAC-75C-75V	42731	SEAL ASSY; 5/8"; SILICON CARBIDE; VITON	\$184.00
BAC-75CB	40109	SEAL ASSY; 5/8" SHAFT; BUNA/SILICON/CARB	\$198.50
BAC-75CE	40150	SEAL ASSY; 5/8" SHAFT; EDPM/SILICON/CARB	\$296.75
BAC-7V	40151	SEAL ASSY; 5/8"; VITON/CARBON/CERAMIC	\$58.50
BAC-7-WS	40139	SEAL; 5/8" SHAFT; DOUBLE SEAL	\$220.50
BAC-80-10SAE	41446	BODY; RESTRICTOR ORIFICE; #10SAE X 1/2"	\$26.50
BAC-80-10X10SAE	41466	BODY; RESTRICTOR ORIFICE; 10SAE X 10SAE	\$26.50
BAC-80-10X8SAE	41461	BODY; RESTRICTOR ORIFICE; #8 X #10 SAE	\$26.50
BAC-80-8SAE	41455	BODY; RESTRICTOR ORIFICE; #8 SAE X 1/2"	\$26.50
BAC-81-QC	41450	COLLAR; BALL RETAINER SLEEVE FOR QC	\$39.25
BAC-82-QC	41460	SPRING FOR QUICK COUPLER	\$14.25
BAC-83-QC	41470	BALL FOR QUICK COUPLER	\$1.75
BACG-33	45165	SNAP RING; INTERNAL FRAME (FMC-CW-800)	\$4.75
BACG-44-A	45191	WASHER; 9/16" LOCK TYPE; SS (FMC-CW-800)	\$50.75
BACG-90M	45270	CARTRIDGE FOR MECHANICAL SEAL	\$143.25
BACH-25	40420	KEY FOR IMPELLER; 1/8" x 1/8" x 7/16" SS	\$1.25
BACH-32-HD	40835	SNAP RING; EXTERNAL; HEAVY DUTY	\$3.75
BACH-33	40820	SNAP RING; INTERNAL	\$1.75
BACL-14-HYD	40302	FRAME FOR 200 SERIES HYD MOTOR; LIP	\$441.00
BACL-6-CW-SS	41505	SHAFT; 5/8"DIA; RH FINE THREAD; LIP; SS	\$169.75
BACL-6-HYD-SS	40062	SHAFT; 5/8"DIA; KW; TANG SLOT; SS	\$182.00
BACL-6-SS	40075	SHAFT; 5/8"DIA; LH COURSE THREAD; SS	\$169.75
BACL-7V	40156	SEAL; VITON LIP	\$53.00
BGK-101	41660	WASHER; 1/4" x 1-1/2" x 2"; RECTANGLE	\$9.25
BGK-101-1	41661	NUT; 1/4" x 1 1/2" x 3 1/2"; RECTANGLE	\$11.75
BGK-104-1	41695	NUT; 1/4" WING NUT	\$0.75
BGK-105-1	41705	CAP SCREW; 5/16"NC x 2-1/4" HEX	\$1.75
BGK-106-1	41715	BOLT; 1/4"NC x 3/4"	\$0.70
BGKB	52610	BELT GUARD KIT	\$187.05
BGKB-1	41653	BELT GUARD; LEFT HALF; PTOC	\$79.25
BGKB-2	41654	BELT GUARD; RIGHT HALF; PTOC	\$79.25
BGKB-HDWR-KT	52611	BELT GUARD KIT; HARDWARE	\$28.55
DPK-1	74005	MANIFOLD ASSEMBLY; FOR DPK KIT	\$2,315.00
DPK-18-MAN-7	74025	VALVE; MANUAL FLOW CONTROL	\$573.25
DPK-18-PRO-7	74040	VALVE ASSEMBLY; PROPORTIONAL	\$606.25
DPK-2	74015	SWITCH BOX ASSEMBLY WITH 15' CABLE	\$441.00
DPK-3	74020	CABLE; 12' IMPLEMENT	\$121.25
DPK-EXT	74010	CABLE; 22' IMPLEMENT EXTENSION (OPTIONAL)	\$121.25
FLG3X2	41528	FLANGE; 3.00 X 2.00 NPT	\$144.25
GE-12-75	42700	VOLUTE FOR GE-75; 3/4" x 1"; POLY	\$152.00
GE-12-75SP	42708	VOLUTE FOR GE-75; 3/4" x 1"; POLY; SELF-PRIMING	\$178.50
GE-14-75	42720	BRACKET FOR GE-75; POLY	\$161.00
GE-14-75SP	42725	BRACKET FOR GE-75SP; POLY; SELF-PRIMING	\$166.50
GE-14-85	42721	BRACKET FOR GE-85; POLY	\$161.00
GE-14-85SP	42726	BRACKET FOR GE-85SP; POLY; SELF-PRIMING	\$166.50
GE-1-A	42060	ENGINE; 3-1/2 HP; B&S #83132-1036F1; TH	\$1,044.00
GE-26-75	42710	IMPELLER FOR GE-75; KEYWAY; POLY	\$71.75
GE-26-85	42711	IMPELLER FOR GE-85; KEYWAY; POLY	\$71.75
GE-26-A	42161	IMPELLER; RH 5/8" THREAD; IRON;	\$257.00
GE-26-A-EC	42161E	IMPELLER; RH 5/8" THREAD; ECOAT IRON;	\$316.50
GE-44	42200	5/16" LOCK WASHER	\$1.25
GE-54	42220	SLINGER; 1.625" OD X 1" ID X .125" THK	\$5.25
GE-54-660	42222	SLINGER; 1.25" OD X .75" ID X .125" THK	\$7.25
GE-55	42221	SLINGER (FOR USE WITH GE-800)	\$7.50
GE-60	42230	CAP SCREW; 5/16" NF x 3/4"; GRADE 5	\$0.75
GE-60-SS	42235	CAP SCREW; 5/16" NF x 3/4"; SS	\$1.75
GE-6-SS-A	42105	SLEEVE FOR 1" SHAFT; STAINLESS; L=1.875	\$90.50
GE-7-V	42120	SEAL; 1" TYPE 6; VITON	\$90.50
GE-8-V-A	42132	O-RING FOR GE-6-A-SS; VITON	\$3.75
GE-9-A	42151	BRACKET (FOR USE WITH GE-1-A ENGINE)	\$330.75
GE-9-A-EC	42151E	BRACKET; ECOAT; FOR GE-1-A ENGINE	\$391.25
LS-204	41409	OBS FLOW LIMITER- 204 HYD MOTOR -3/8"NPT	\$102.50
LS-204N	41417	FLOW LIMITER-204N HYD MOTOR-#8x1/2NPT	\$102.50
LS-206	41408	OBS-FLOW LIMITER-206 HYD MOTOR-3/8"NPT	\$102.50
LS-206N	41418	FLOW LIMITER-206N HYD MOTOR-#8x1/2NPT	\$102.50
LS-206N-10X8SAE	41424	FLOW LIMITER; 206N; 8MX10F SAE	\$102.50
LS-210	41411	OBS FLOW LIMITER; 210 HYD MOTOR; 3/8"NPT	\$102.50
LS-210N	41423	FLOW LIMITER-210N HYD MOTOR;#8x1/2"NPT	\$102.50
LS-304	41413	FLOW LIMITER FOR 304 HYD MOTOR	\$102.50
LS-304N	41429	FLOW LIMITER FOR 304N HYD MOTOR	\$102.50
OASIS-RES	45281	EXTERNAL WET SEAL RESERVOIR	\$694.50
PWM-1	74200	MANIFOLD; ASSEMBLY FOR 304-PWM	\$1,256.75
PWM-1-206	74201	MANIFOLD; ASSEMBLY FOR 206-PWM	\$1,256.75
PWM-1-206R	74202	MANIFOLD; ASSEMBLY FOR 206R-PWM	\$1,256.75
PWM-18-PRO-11	74220	VALVE ASSEMBLY; 12V PROPORTIONAL	\$882.00
PWM-18-PRO-18	74224	VALVE ASSEMBLY; 12V PROPORTIONAL	\$1,234.75
PWM-18-PRO-20	74226	VALVE ASSEMBLY; 12V PROPORTIONAL BUCHER	\$1,234.75
PWM-18-PRO-6	74222	VALVE ASSEMBLY; 12V PROPORTIONAL	\$890.75
PWM-18-PRV-11	74210	VALVE; PRESSURE REDUCING	\$344.00
RK-1606S	91350	REPAIR KIT ASSY; VALVE 3/4"	\$132.00
RK-1608S	91360	REPAIR KIT ASSY; VALVE 1"	\$154.75
RK-1610S	91370	REPAIR KIT ASSY; VALVE	\$195.25
RK-1612S	91380	REPAIR KIT; VALVE	\$195.25
RK-1616S	91390	REPAIR KIT; VALVE	\$253.25
RK-BAC-75-HYD	41371	OBS; REPAIR KIT ASSY; 200 HYD MOTOR-QUAD	\$121.50
RK-BAC-75-HYD-300	41361	OBS; REPAIR KIT; 304 & 307 MOTOR-QUAD	\$121.50
RK-BAC-75-HYD-300-L	41362	REPAIR KIT ASSY; 300 HYD MOTOR; (LIP SEA	\$121.50

Part Number	EDP	Description	List Price
RK-BAC-75-HYD-310	41379	OBS; REPAIR KIT 310 HYD MOTOR-QUAD RING	\$121.50
RK-BAC-75-HYD-L	41374	REPAIR KIT ASSY; 200 SERIES HYD MOTOR (L	\$72.25
RK-BAC-75-M	40138	REPAIR KIT ASSY; M SERIES; EFF. 6/15	\$186.75
RK-DPK	74050	SEAL KIT; MANIFOLD CARTRIDGE VALVES	\$134.25
RK-FMC	52700	REPAIR KIT ASSY	\$69.50
RK-FMC-150	52710	REPAIR KIT ASSY	\$69.50
RK-FMC-650	52720	REPAIR KIT ASSY	\$123.75
RK-FMC-750	52724	REPAIR KIT ASSY	\$411.75
RK-FMC-750-CSC	52731	REPAIR KIT ASSY	\$151.50
RK-FMC-750-CSC-LF	52733	REPAIR KIT ASSY; 750 WETSEAL MODELS	\$28.50
RK-FMC-750-LF	52727	REPAIR KIT ASSY	\$288.75
RK-FMC-75SP	60842	REPAIR KIT ASSY; FMC-75SP	\$97.50
RK-FMC-850	52725	REPAIR KIT ASSY	\$465.75
RK-FMC-855	52726	REPAIR KIT ASSY	\$536.50
RK-FMC-CW-800	52715	REPAIR KIT ASSY	\$162.00
RK-FMCL	51900	REPAIR KIT ASSY	\$115.25
RK-FMCL-T	51905	REPAIR KIT ASSY; LIP SEAL; PTFE	\$207.75
RK-FMCSC	52706	REPAIR KIT ASSY; SILICON CARBIDE SEAL	\$212.75
RK-FMCSC-150	52711	REPAIR KIT ASSY; SILICON CARBIDE SEAL	\$212.75
RK-FMCSC-155	52713	REPAIR KIT; SILICON CARBIDE SEAL FOR 155	\$212.75
RK-FMCSC-205	52705	REPAIR KIT ASSY	\$212.75
RK-FMCSC-650	52721	REPAIR KIT ASSY	\$248.50
RK-FMCSC-75SP	60843	REPAIR KIT ASSY; FMCSC-75SP; SILICON CARBIDE	\$224.25
RK-FMCSC-CW-800	52716	REPAIR KIT ASSY; SILICON CARBIDE SEAL	\$371.75
RK-FMCSCCE	52707	REPAIR KIT; SILICON CARBIDE SEAL; EDPM	\$309.25
RK-FMCSC-PRO5	52717	REPAIR KIT ASSY	\$220.25
RK-FMCWS-650	52722	REPAIR KIT ASSY; 650 WETSEAL MODELS	\$308.25
RK-FMCWS-650-CSC	52729	REPAIR KIT ASSY; 650 WETSEAL MODELS	\$368.75
RK-FMCWS-650-CSC-LF	52732	REPAIR KIT ASSY; 650 WETSEAL MODELS	\$307.25
RK-FMCWS-650-LF	52723	REPAIR KIT ASSY; 650 WETSEAL MODELS	\$246.75
RK-FMCWS-PRO5	52728	REPAIR KIT ASSY; PRO5 WETSEAL MODELS	\$300.50
RK-GE-100-A	60855	REPAIR KIT ASSY	\$102.75
RK-GE-650	61153	REPAIR KIT ASSY	\$103.50
RK-GE-660	61162	REPAIR KIT ASSY	\$92.25
RK-GE-75	60840	REPAIR KIT ASSY; GE-75	\$85.75
RK-GE-75-IMP	60849	REPAIR KIT ASSY; GE-75 WITH IMPELLER	\$157.50
RK-GE-800/1600	61000	REPAIR KIT ASSY	\$170.75
RK-GE-800/1600-SG	61005	REPAIR KIT ASSY; SILICON GRAPHITE SEAL	\$364.75
RK-GE-85	60845	REPAIR KIT ASSY; GE-85	\$100.25
RK-GE-85-IMP	60844	REPAIR KIT ASSY; GE-85 WITH IMPELLER	\$172.00
RK-GE-85SP	60847	REPAIR KIT ASSY; GE-85SP	\$112.00
RK-GE-860/1660	61010	REPAIR KIT ASSY	\$188.25
RK-GESC-660	61167	REPAIR KIT ASSY SILICON CARBIDE SEAL	\$247.50
RK-GESC-75	60841	REPAIR KIT ASSY; GE-75; SILICON CARBIDE	\$212.50
RK-GESC-75-IMP	60851	REPAIR KIT ASSY; GESC-75 WITH IMPELLER	\$285.00
RK-GESC-85	60846	REPAIR KIT ASSY; GE-85; SILICON CARBIDE	\$255.50
RK-GESC-85SP	60848	REPAIR KIT ASSY; GE-85SP; SILICON CARBIDE	\$267.25
RK-GESC-860/1660	61011	REPAIR KIT ASSY	\$341.25
RK-PTOC-1000	51250	REPAIR KIT ASSY	\$137.25
RK-PTOC-150-1000	51255	REPAIR KIT ASSY	\$144.00
RK-PTOC-150-600	51155	REPAIR KIT ASSY	\$142.75
RK-PTOC-600	51150	REPAIR KIT ASSY	\$136.25
RK-PTOCSC-150-600	51156	REPAIR KIT ASSY; SEVERE DUTY SEAL	\$286.00
RK-RP-600	14975	REPAIR KIT; 6 ROLLER PUMP; UNIVERSAL	\$62.50
RK-RP-800	14950	REPAIR KIT; 8 ROLLER PUMP; UNIVERSAL	\$87.00
RP-BP6	15205	KIT, BASEPLATE, 6 ROLLER PUMP	\$49.75
RP-BP8	15200	KIT, BASEPLATE, 8 ROLLER PUMP	\$55.00
RP-TBK	15100	TORQUE BAR KIT	\$80.50
RP-TBK-1	15105	TORQUE BAR; RECTANGLE TUBE	\$66.00
RP-TBK-5	15110	SPRING; DRAWBAR; FOR ROLLER PUMP TORQUE BAR KIT	\$7.25
RP-TBK-87-18	15120	CHAIN; TORQUE; 18"; FOR ROLLER PUMP TORQUE BAR KIT	\$7.25
RP-TBK-87-20	15115	CHAIN; TENSIONING; 20"; FOR ROLLER PUMP TORQUE BAR KIT	\$5.50
S200	40161	SPACER FOR 200 SERIES HYDRAULIC LIP SEAL	\$11.75
S255	40177	SPACER FOR 200 SERIES LIP SEAL 155 PUMP	\$15.00
S300	40162	SPACER FOR 300 SERIES HYDRAULIC LIP SEAL	\$11.75
S305	40163	SPACER; 205 PUMP; 300 SERIES MOTOR SEAL	\$18.75
SK-0625-21V/SC5	33027	SEAL KIT; MPH-100-100SE	\$156.00
SP-62	42255	CAP SCREW; 5/16"NFx1"HEX HEAD	\$1.00
TYPE 16-625-SC	30245	SEAL; TYPE 16; 5/8" SHAFT; SILICON CARB	\$302.00
TYPE 21-1.250	30265	SEAL; TYPE 21; 1.25" SHAFT; VITON; .85WH	\$155.50
TYPE 21-1.250-SG	30266	SEAL; TYPE 21; 1.25" SHAFT; SG; VITON	\$337.25
TYPE 21-1.250-V60	30267	SEAL; T21; 1.25" SHAFT; VITON; WH 1-1/16	\$161.00
TYPE 21-1.250-V60-SG	30268	SEAL; T21; 1.25" SHAFT; VITON; WH 1-1/16	\$314.00
TYPE 21-100	30260	SEAL; TYPE 21; 1" SHAFT; VITON USE 984	\$103.75
TYPE 21-625	30240	SEAL; TYPE 21; 5/8" SHAFT; VITON	\$96.00
TYPE 21-625-SG	30246	SEAL; TYPE 21; 5/8" SHAFT; SILICON GRAPH	\$303.25
TYPE 21-750	30250	SEAL; TYPE 21; 3/4" SHAFT; VITON	\$98.25
TYPE 21-984	30255	SEAL; TYPE 21; .984" SHAFT; VITON	\$136.75
TYPE 21-984-SC	30256	SEAL; TYPE 21; .984" SHAFT; SC; VITON	\$353.75
TYPE 6-625	30210	SEAL; TYPE 6; 5/8" SHAFT; BUNA N	\$52.00
TYPE 6-750	30220	SEAL; TYPE 6; 3/4" SHAFT; BUNA N	\$58.50

NUMERICAL PARTS LISTING

FDP	Part Number	Description	List Price
10850	820	KEY; STEEL; .250" X .250" X .875"	\$1.25
14802	14802	COVER; 8 ROLLER; CAST IRON	\$106.75
14804	14804	ROLLER; ARMOUR	\$5.00
14808	14808	SEAL FOR 25 MM SHAFT; 8 ROLLER PUMP; VITON	\$22.50
14809	14809	BEARING; SINGLE ROW; 8 ROLLER	\$20.25
14811	14811	O-RING FOR 8 ROLLER PUMP	\$2.00
14813	14813	DUST CAP; THERMOPLASTIC; 8 ROLLER	\$2.00
14814	14814	DUST CAP; SHAFT; THERMOPLASTIC; 8 ROLLER	\$2.00
14830	BAC-10-RP8-QC	QUICK COUPLER ASSY; 8 ROLLER; 25MM X 6 AND 21 SPLINE	\$71.75
14852	14852	COVER; 6 ROLLER; CAST IRON	\$80.50
14858	14858	SEAL 5/8" SHAFT; 6 ROLLER PUMP; VITON	\$14.25
14859	14859	BEARING; SINGLE ROW; 6 ROLLER	\$13.75
14861	14861	O-RING; 6 ROLLER PUMP	\$2.00
14863	14863	DUST CAP; THERMOPLASTIC; 6 ROLLER	\$2.00
14864	14864	DUST CAP; SHAFT; THERMOPLASTIC; 6 ROLLER	\$2.00
14865	14865	O-RING; 6 ROLLER PUMP	\$2.00
14879	14879	KEY; STEEL; .250" X .250" X 1.500"	\$1.25
14880	BAC-10-RP6-QC	QUICK COUPLER ASSY; 6 ROLLER; 5/8" X 6 AND 21 SPLINE	\$67.25
14902	14902	SLEEVE; BALL RETAINER	\$44.25
14903	14903	SPRING; QUICK COUPLER	\$14.25
14904	14904	BALL; QUICK COUPLER	\$1.50
14905	14905	SET SCREW; 5/16" NC; CUP POINT	\$1.00
14908	14908	BALL; QUICK COUPLER	\$1.55
14950	RK-RP-800	REPAIR KIT; 8 ROLLER PUMP; UNIVERSAL	\$87.00
14975	RK-RP-600	REPAIR KIT; 6 ROLLER PUMP; UNIVERSAL	\$62.50
15100	RP-TBK	TORQUE BAR KIT	\$80.50
15105	RP-TBK-1	TORQUE BAR; RECTANGLE TUBE	\$66.00
15110	RP-TBK-5	SPRING; DRAWBAR; FOR ROLLER PUMP TORQUE BAR KIT	\$7.25
15115	RP-TBK-87-20	CHAIN; TENSIONING; 20"; FOR ROLLER PUMP TORQUE BAR KIT	\$5.50
15120	RP-TBK-87-18	CHAIN; TORQUE; 18"; FOR ROLLER PUMP TORQUE BAR KIT	\$7.25
15200	RP-BP8	KIT, BASEPLATE; 8 ROLLER PUMP	\$55.00
15205	RP-BP6	KIT, BASEPLATE; 6 ROLLER PUMP	\$49.75
20730	20730	WASHER; 5/16"; FLAT	\$0.60
20750	20750	PLUG; OIL FILLER; 1/4"NPT	\$6.50
30009	ACAL-4	O-RING; VOLUTE SEAL	\$14.25
30017	ACAL-6-SS-A	SHAFT; SS STEEL; (for FMC-CW-800-DRB)	\$343.00
30018	ACAL-7-SS	SHAFT SLEEVE FOR GE-800; SS STEEL	\$231.50
30019	ACAL-6-SS-D	SHAFT; SS STEEL; (for FMC-CW-800-MAG-D)	\$358.25
30022	30022	CAP SCREW 7/16" UNF X 1-1/4; SS	\$3.00
30023	30023	WASHER; 7/16" SEALING; GE-860	\$1.75
30028	30028	WASHER; 5/16 ID; SEALING; SS	\$2.25
30029	30029	WASHER; 3/8" ID; SEALING; SS	\$2.25
30031	30031	WASHER; STAT-O-SEAL; 5/16" ID	\$5.00
30035	30035	THREAD LOCKER; REMOVABLE	\$7.00
30037	30037	LUBRICANT; 10 ML	\$11.25
30039	30039	SEALANT; FORM-A-GASKET; 3.3G FOIL PACK	\$6.25
30044	ACAL-143-EC	BRACKET FOR GE-800 AND GE-1600	\$655.00
30045	ACAL-143	BRACKET FOR GE-800 AND GE-1600	\$583.25
30047	ACAL-26-TH	IMPELLER; 1" UNF RH THREAD; CAST IRON	\$565.50
30070	5AC-9-625	BRACKET; 5/8" BORE; 4 HOLE; CAST IRON	\$240.25
30100	5AC-10	VOLUTE; 1-1/4" x 1"; CW ROTATION; IRON	\$350.50
30100E	5AC-10-EC	VOLUTE; 1-1/4" x 1"; CW ROTATION; ECOAT	\$410.00
30130	6AC-12	VOLUTE; 1-1/2" x 1-1/4"; CW; CAST IRON	\$381.50
30139	ACAL-16-EC	VOLUTE; 2-1/2" x 2" NPT; CW; CAST IRON	\$784.00
30144	BAC-12-650-FLG-NPP	VOLUTE; 1-1/2" x 1-1/4"; CCW; FLANGED	\$567.75
30145	7AC-14-4	VOLUTE; 2" x 1-1/2"; 4 HOLE; IRON; CW	\$418.75
30146	7AC-14-4-EC	VOLUTE; 2" x 1-1/2"; 4 HOLE; IRON; CW; EC	\$478.50
30147	BAC-12-125	VOLUTE; 1-1/4" x 1"; CAST IRON	\$376.00
30148	BAC-12-750-FLG-NPP	VOLUTE; 750 MODELS; CCW; FLANGED; CI	\$737.75
30149	BAC-12-255-FLG	VOLUTE; 1-1/2" x 1-1/4"; FLANGED; E-COATED	\$583.25
30151	ACAL-14-EC	VOLUTE; 2" x 1-1/2"; CW ROT; ECOAT IRON	\$552.25
30152	BAC-12-750-SS	VOLUTE; 750 MODELS; CCW; FLANGED; SS	\$1,200.50
30153	BAC-12-650-BSP	VOLUTE; 1-1/2" x 1-1/4" BSP; CCW ROTATION	\$505.00
30154	BAC-12-855F	VOLUTE; 300 X 300 FLG; CCW ROTATION	\$2,385.50
30155	ACAL-12-650	VOLUTE; 1-1/2" x 1-1/4"; CW ROTATION; IR	\$455.25
30156	BAC-12-650-FLG-SS	VOLUTE; 1-1/2" x 1-1/4"; FLANGED; STAINLESS STEEL	\$1,079.25
30158	BAC-12-750-FLG	VOLUTE; 750 MODELS; CCW; FLANGED; CI	\$737.50
30159	BAC-12-650-FLG	VOLUTE; 1-1/2" x 1-1/4"; CCW; FLANGED	\$567.75
30160	ACAL-14	VOLUTE; 2" x 1-1/2"; CW ROTATION; IRON	\$492.75
30161	ACAL-12	VOLUTE; 1-1/2" x 1-1/4"; CW ROTATION; IR	\$387.00
30163	BAC-12-650	VOLUTE; 1-1/2" x 1-1/4" NPT; CCW ROTATION	\$469.50
30168	ACAL-15-MAG-D	FRAME; FOR FMC-CW-800-MAG-D	\$727.50
30169	BAC-26-650	IMPELLER; FMC-650; 3/4" KEY SHAFT; CI	\$317.50
30170	ACAL-16	VOLUTE; 2-1/2" x 2" NPT; CW; CAST IRON	\$737.50
30171	ACAL-28-660	IMPELLER; GE-660; 3/4" KEY SHAFT; CI	\$392.25
30173	ACAL-28	IMPELLER; 5/8" THREAD; 650 PUMP	\$404.50
30174	ACAL-32	SNAP RING; EXTERNAL	\$2.25
30176	ACAL-32-S-A	SPACER FOR ACAL-6; .985" LENGTH	\$41.75
30179	ACAL-37-DRB	BEARING; SEALED; DOUBLE ROW	\$174.25
30182	BAC-26-750-CI	IMPELLER; FMC-750; CI	\$565.50
30185	ACAL-55	BRACKET FOR GE-650	\$595.50
30186	ACAL-66	BRACKET; GE-660 KEYS SHAFT	\$375.00
30187	ACAL-88	BRACKET; GE-860	\$535.75
30189	BAC-26-750-SS	IMPELLER; FMC-750; STAINLESS STEEL	\$630.50
30191	BAC-26-650-SS	IMPELLER; FMC-650; 3/4" KEY SHAFT; SS	\$555.50
30192	BAC-26-650-WS	IMPELLER; FMCWS-650; 3/4" KEY; E-COAT	\$372.50
30193	BAC-26-650-WS-SS	IMPELLER; FMCWS-650; 3/4" KEY; 316 SS	\$600.75
30195	ACAL-28-660-EC	IMPELLER; GE-660; 3/4" KEY SHAFT; ECOAT	\$452.00
30196	ACAL-12-EC	VOLUTE; 1-1/2" x 1-1/4"; CW ROT; ECOAT	\$464.00
30197	ACAL-66-EC	BRACKET; GE-660 KEYS SHAFT; ECOAT	\$434.50
30198	BAC-26-855-CI	IMPELLER; FMC-855-HYD; CI	\$1,083.75
30199	ACAL-88-EC	BRACKET; GE-860; ECOAT	\$595.50
30210	TYPE 6-625	SEAL; TYPE 6; 5/8" SHAFT; BUNA N	\$52.00
30220	TYPE 6-750	SEAL; TYPE 6; 3/4" SHAFT; BUNA N	\$58.50
30225	BAC-7-660V	SEAL; TYPE 6A-3/4; VITON; O-RING OD	\$71.75
30226	BAC-7SC-660V	SEAL ASSY; TYPE 6A-3/4; SC/SC; O-RING OD	\$227.00

EDP	Part Number	Description	List Price
30240	TYPE 21-625	SEAL; TYPE 21; 5/8" SHAFT; VITON	\$96.00
30245	TYPE 16-625-SC	SEAL; TYPE 16; 5/8" SHAFT; SILICON CARB	\$302.00
30246	TYPE 21-625-SG	SEAL; TYPE 21; 5/8" SHAFT; SILICON GRAPH	\$303.25
30250	TYPE 21-750	SEAL; TYPE 21; 3/4" SHAFT; VITON	\$98.25
30255	TYPE 21-984	SEAL; TYPE 21; .984" SHAFT; VITON	\$136.75
30256	TYPE 21-984-SC	SEAL; TYPE 21; .984" SHAFT; SC; VITON	\$353.75
30260	TYPE 21-100	SEAL; TYPE 21; 1" SHAFT; VITON USE 984	\$103.75
30265	TYPE 21-1.250	SEAL; TYPE 21; 1.25" SHAFT; VITON; .85WH	\$155.50
30266	TYPE 21-1.250-SG	SEAL; TYPE 21; 1.25" SHAFT; SG; VITON	\$337.25
30267	TYPE 21-1.250-V60	SEAL; T21; 1.25" SHAFT; VITON; WH 1-1/16	\$161.00
30268	TYPE 21-1.250-V60-SG	SEAL; T21; 1.25" SHAFT; VITON; WH 1-1/16	\$314.00
30553	ACAL-28-EC	IMPELLER FOR GE-650; ECOATED	\$474.00
30554	ACAL-55-EC	BRACKET FOR GE-650	\$655.00
30555	ACAL-26-75	IMPELLER; 8"DIA; CW-800; KEYWAY; IRON	\$565.50
30556	ACAL-28-660-P	IMPELLER; KEYWAY; THERMOPLASTIC	\$138.75
30558	ACAL-26-860	IMPELLER; GE-860; CAST IRON; KEYED SHAFT	\$565.50
30559	ACAL-26-860-EC	IMPELLER; GE-860; ECOAT IRON; KEYED SHAFT	\$625.00
30561	ACAL-30-1600	IMPELLER; IRON; 1" UNF RH THREAD	\$545.75
30562	ACAL-30-1600-EC	IMPELLER; IRON; 1" UNF RH THREAD; E-COATE	\$605.25
31040	31040	GASKET FOR 5AC-10 VOLUTE; 4 HOLE	\$7.25
31130	9000	GASKET	\$7.25
33027	SK-0625-21V/SC5	SEAL KIT; MPH-100-100SE	\$156.00
33402	7MP-23-875-4.75	IMPELLER; CAST-IRON 4-3/4"	\$596.25
40005	BAC-4A	O-RING FOR BAC-12 VOLUTE	\$9.25
40006	BAC-4A-E	O-RING FOR BAC-12 VOLUTE; EDPM	\$10.75
40010	BAC-4	GASKET; 4 HOLE	\$4.75
40012	40012	O-RING; VOLUTE TO DIFFUSER SEAL; GE-75SP	\$11.75
40014	40014	O-RING; VOLUTE SEAL; GE-75SP	\$16.00
40015	BAC-4-150	O-RING; VOLUTE SEAL	\$9.25
40016	BAC-4-150-E	O-RING; VOLUTE SEAL; EPDM	\$10.75
40017	40017	O-RING; VOLUTE SEAL; GE-75	\$16.00
40018	40018	O-RING; VOLUTE SEAL; FMC-850	\$17.50
40030	BAC-5	SPRING; TORSION; FOR PTOC IDLER ARM	\$26.75
40035	BAC-5-150	SPRING; TORSION; FOR PTOC-150 IDLER	\$30.50
40045	BAC-6-650-D-SS-WS	SHAFT; .984 DIA; TAPERED; SS	\$338.50
40046	BAC-6-75-SS	SHAFT; 5/8"DIA; BELT DRIVE	\$150.00
40047	BAC-6-650-SS-WS	SHAFT; .984 DIA; SS; WET SEAL	\$356.25
40048	BAC-6-75-HYD-SS	SHAFT; 5/8"DIA; TANG DRIVE	\$150.00
40049	BAC-6-650-HYD-SS-WS	SHAFT; 1" DIA; 650 WS; SPLINED; SS	\$460.75
40051	BAC-6-650-HYD-SS	SHAFT; 1.13" DIA; 11 TOOTH SPLINE; SS	\$400.25
40052	BAC-6-650-D-SS	SHAFT; .984 DIA; TAPERED; SS	\$307.50
40053	BAC-6-650-SS	SHAFT; .984 DIA; SS	\$302.00
40054	BAC-6X-200-SS	SHAFT; 3/4"DIA; .922" KW; SS	\$270.25
40056	BAC-6-150/200-SS	SHAFT; 5/8"DIA; KEYWAY; STAINLESS	\$157.50
40057	BAC-6-200-SS	SHAFT; 5/8"DIA; KEYWAY; FOR 2" CCW; SS	\$150.00
40058	BAC-6-200-D-SS	SHAFT; 5/8"DIA; .922" KW; 5/16" HOLE; SS	\$182.00
40059	BAC-6X-200-D-SS	SHAFT; 5/8"DIA; .922" KW; 5/16" HOLE; SS	\$275.50
40061	BAC-6-HYD-SS	SHAFT; 5/8"DIA; KEYWAY; TANG SLOT; SS	\$157.50
40062	BACL-6-HYD-SS	SHAFT; 5/8"DIA; KW; TANG SLOT; SS	\$182.00
40063	BAC-6-HYD-200-SS	SHAFT; 5/8"DIA; KEYWAY; TANG SLOT; SS	\$157.50
40065	BAC-6-850-HYD-SS	SHAFT; 1-1/8"DIA; KEYWAY; SS	\$640.50
40066	BAC-6-750-HYD-SS-WS	SHAFT; KEYWAY; .750 WS; SPLINED; SS	\$545.75
40067	BAC-6-750-SS-WS	SHAFT; KEYWAY; SS	\$446.50
40068	BAC-6-205-HYD-SS	SHAFT; 17MM DIA; KEYWAY; TANG SLOT; SS	\$239.25
40070	BAC-6-SS	SHAFT; 5/8"DIA; LH COURSE THREAD; SS	\$160.00
40071	BAC-6-D-SS	SHAFT; 5/8"DIA; LH THREAD; 5/16" HOLE; SS	\$194.00
40072	BAC-6-155-HYD-SS	SHAFT; 17MM DIA; KEYWAY; TANG SLOT; SS	\$263.50
40075	BACL-6-SS	SHAFT; 5/8"DIA; LH COURSE THREAD; SS	\$169.75
40076	BAC-6-150-D-SS	SHAFT; 5/8"DIA; 5" KW; 5/16" HOLE; SS	\$200.75
40077	BAC-6-SP-HYD-SS	SHAFT; TANSFER PUMP; TANG DRIVE	\$157.50
40109	BAC-7SCB	SEAL ASSY; 5/8" SHAFT; BUNA/SILICON/CARB	\$198.50
40110	BAC-7B	SEAL; 5/8" SHAFT; BUNA N	\$66.00
40131	BAC-7CSC-650-WS	SEAL; 3/4" SHAFT; DOUBLE SEAL	\$286.50
40132	40132	INSTALLATION TOOL; FMCWS	\$44.25
40138	RK-BAC-75-M	REPAIR KIT ASSY; M SERIES; EFF. 6/15	\$186.75
40139	BAC-7-WS	SEAL; 5/8" SHAFT; DOUBLE SEAL	\$220.50
40142	40142	INSTALLATION TOOL; FMC-650 SEALS	\$44.25
40143	BAC-7-650-WS	SEAL; 3/4" SHAFT; DOUBLE SEAL	\$226.00
40144	BAC-7-650B	SEAL; 3/4" SHAFT; BUNA/CARBON/CERAMIC	\$101.50
40145	BAC-7-650	SEAL; 3/4" SHAFT; VITON/CARBON/CERAMIC	\$112.25
40146	BAC-7SC-650	SEAL ASSY; 3/4" SHAFT; VITON/SILICON CAR	\$237.00
40147	BAC-7-750V	SEAL ASSY; TYPE 21; DUAL .875; VITON	\$260.25
40148	BAC-7-850V	SEAL ASSY; TYPE 21; DUAL 1.250; VITON	\$369.25
40149	BAC-7SC-205V	SEAL ASSY; 5/8" SHAFT; VITON/SC; 205 PUMP	\$201.75
40150	BAC-7SCE	SEAL ASSY; 5/8" SHAFT; EDPM/SILICON/CARB	\$296.75
40151	BAC-7V	SEAL ASSY; 5/8"; VITON/CARBON/CERAMIC	\$58.50
40152	BAC-7SC	SEAL ASSY; 5/8"; VITON/SILICON/CARBIDE	\$201.75
40153	BAC-75-200-TLS	SEAL ASSY; 200 SER HYD MOTOR; TEFLON LIP	\$56.25
40154	BAC-75-300-TLS	SEAL ASSY; 300 SER HYD MOTOR; TEFLON LIP	\$99.25
40156	BACL-7V	SEAL; VITON LIP	\$53.00
40158	300BULLET	BULLET; TOOL FOR 300 SRS HYD LIP SEAL	\$4.75
40159	40159	O-RING FOR GE-7-75V SEAL	\$1.25
40160	40160	O-RING FOR 5/8" SHAFT SEAL	\$1.25
40161	S200	SPACER FOR 200 SERIES HYDRAULIC LIP SEAL	\$11.75
40162	S300	SPACER FOR 300 SERIES HYDRAULIC LIP SEAL	\$11.75
40163	S305	SPACER; 205 PUMP; 300 SERIES MOTOR SEAL	\$18.75
40164	BAC-75-M-FKM	SEAL ASSY; M SERIES HYD MOTOR; FKM(VITON)	\$73.75
40169	40169	O-RING FOR 5/8" SHAFT SEAL; EPDM	\$1.25
40170	40170	ONE WHEEL; SINGLE TOOTH FOR 650 PUMP	\$58.00
40171	40171	SET SCREW; 10-24 x 1/2" DOG POINT	\$1.00
40172	40172	OMRON SENSOR WITH PLUG	\$140.00
40177	S255	SPACER FOR 200 SERIES LIP SEAL 155 PUMP	\$15.00
40180	BAC-10-175-20SP	SHAFT ASSY; 1.75"-20 SPLINE; BAC-11-175	\$534.50
40181	40181	ONE WHEEL; 2 PULSE PER REV FOR STD PUMPS	\$63.00
40190	BAC-10-S	SHAFT; 1" STUB	\$396.75
40191	40191	O-RING FOR 1/2" PLUG	\$0.60
40200	BAC-10-6SP	SHAFT ASSY; 1.375"-6 SPLINE	\$396.75
40210	BAC-10-6SPQC	SHAFT ASSY; 1.375"-6 SPLINE; QUICK COUPL	\$402.50
40220	BAC-10-21SP	SHAFT ASSY; 1.375"-21 SPLINE; BAC-11 COL	\$507.00
40235	BAC-11	COLLAR FOR BAC-10-21SP; 1.375" SHAFT	\$141.25

FDP	Part Number	Description	List Price
40236	BAC-11-175	COLLAR FOR BAC-10-20SP; 1.75" SHAFT	\$192.00
40237	BAC-11-1	CAP SCREW; 5/16"NF X 1" SOCKET HEAD	\$1.25
40249	BAC-12-150-SS	VOLUTE; FLANGED; 316 STAINLESS STEEL	\$1,016.25
40250	BAC-12	VOLUTE; 1-1/4" x 1"; CAST IRON	\$307.50
40253	BAC-12-CW	VOLUTE; 1-1/4" x 1"; CI; CW ROTATION	\$307.50
40254	BAC-12-150-SP	VOLUTE; 1.5"x 1.25"; SELF-PRIMING; CAST	\$952.50
40255	BAC-12-150	VOLUTE; 1-1/2" x 1-1/4"; CAST IRON	\$381.50
40257	BAC-12-150-FLG	VOLUTE; FLANGED; CAST IRON	\$455.25
40261	BAC-12-BSP	VOLUTE; 1-1/4" x 1" BSP; CAST IRON	\$340.50
40262	BAC-12-150-BSP	VOLUTE; 1-1/2" x 1-1/4" BSP; CAST IRON	\$433.25
40264	7AC-14-CCW-BSP	VOLUTE; 2" x 1.5" BSP; CCW; IRON	\$462.00
40265	BAC-12-CW-EC	VOLUTE; 1-1/4" x 1"; CI; CW ROTATION; ECOAT	\$367.00
40266	BAC-12-150-FLG-EC	VOLUTE; FLANGED; CAST IRON; ECOATED	\$514.75
40270	BAC-13	IDLER ARM	\$108.25
40285	BAC-14-MAG	FRAME FOR MAG CLUTCH	\$389.25
40286	BAC-14-MIA-EC	FRAME FOR IDLER ARM; E-COATED	\$387.00
40287	BAC-14-650-MAG-WS	FRAME FOR FMCWS-650-MAG-D CLUTCH	\$678.00
40288	BAC-14-5-HYD	FRAME FOR PRO5 SERIES PUMPS	\$434.50
40289	BAC-14-650-HYD-WS	FRAME FOR FMCWS-650-HYD	\$856.50
40290	BAC-14-MIA	FRAME FOR IDLER ARM	\$338.50
40293	BAC-14-75-HYD	FRAME FOR HYD MOTOR; 75 SERIES	\$314.00
40294	BAC-14-855-HYD	FRAME; FMC-855-HYD	\$1,878.50
40296	BAC-14X-MIA-LIN	FRAME; X SERIES; MACHINED FOR IDLER	\$490.50
40297	BAC-14-650-MAG	FRAME FOR 650-MAG-D CLUTCH	\$678.00
40300	BAC-14-HYD	FRAME FOR 200 SERIES HYD MOTOR	\$394.75
40301	BAC-14-HYD-300	FRAME FOR 300 SERIES HYD MOTOR	\$418.75
40302	BACL-14-HYD	FRAME FOR 200 SERIES HYD MOTOR; LIP	\$441.00
40304	BAC-14-150-HYD-300	FRAME FOR 300 HYD MOTOR; 150 SERIES	\$505.00
40305	BAC-14-150-HYD	FRAME FOR HYD MOTOR; 150 SERIES	\$475.00
40306	BAC-14-150-F	FRAME; 150 SERIES	\$401.25
40307	BAC-14-150-MAG	FRAME; 150 SERIES; FOR MAG CLUTCH	\$443.00
40308	BAC-14-150-MIA	FRAME FOR IDLER ARM; 150 SERIES	\$401.25
40309	BAC-14X-F	FRAME FOR X SERIES PUMP	\$425.50
40310	BAC-14-F	FRAME	\$319.75
40312	BAC-14X-F-A	FRAME FOR X SERIES PUMP	\$474.00
40313	BAC-14X-MIA	FRAME; X SERIES; MACHINED FOR IDLER	\$474.00
40314	BAC-14-HYD-300A	FRAME; 300A SERIES MOTOR	\$431.00
40314P	BAC-14-HYD-300A-BLK	FRAME; 300A SERIES MOTOR; BLACK	\$431.00
40316	BAC-14X3-MIA	FRAME; X SERIES; MACHINED FOR IDLER	\$448.75
40319	BAC-14-150-HYD-SS	FRAME FOR HYD MOTOR; 150 SERIES; 316 SS	\$1,067.00
40325	BAC-14-650-HYD	FRAME FOR FMC-650-HYD	\$739.75
40326	BAC-14-F-A	FRAME; PROG AG	\$370.00
40328	BAC-14-150-HYD-300A	FRAME FOR 300A HYD MOTOR; 150 PUMP	\$517.25
40333	BAC-14-750-HYD	FRAME; FMC-750-HYD; CI	\$923.75
40336	BAC-14-LIN	BRACKET FACE; SS STAMPED LINER	\$170.75
40337	BAC-14-HYD-300A-LIN	FRAME; 300A SERIES; SS LINER	\$505.00
40338	BAC-14-205-HYD	FRAME; 300A SERIES MOTOR; 203 BEARING	\$448.75
40340	BAC-15	HOUSING FOR DRIVE SHAFT; PTOC	\$252.50
40343	BAC-14-650-HYD-LIN	FRAME; BAC-14-650-HYD-LIN	\$798.25
40344	BAC-16-650-LIN	LINER; SEAL RETAINER; 650SS	\$433.25
40345	BAC-14-150-HYD-300A-SS	FRAME FOR 300A HYD MOTOR; 150 PUMP	\$1,079.25
40346	BAC-14-205-HYD-SS	FRAME; 300A SERIES MOTOR; STAINLESS STEE	\$1,079.25
40348	BAC-14-155-HYD-SS	FRAME FOR HYD MOTOR; 155 SERIES; 316 SS	\$1,067.00
40349	BAC-14-650-LIN	FRAME; FOR FMC-650FS-MAG-D	\$702.00
40351	BAC-15-A-6SP	HOUSING ASSY; 6 SPLINE SHAFT	\$1,094.50
40352	BAC-15-A-QC	HOUSING ASSY; 6 SPLINE QC SHAFT	\$1,100.25
40353	BAC-15-A-175	HOUSING ASSY; 20 SPLINE SHAFT	\$1,244.50
40354	BAC-15-150-A-6SP	HOUSING ASSY; 150 SRS; 6 SPLINE SHAFT	\$1,113.25
40355	BAC-15-150-A-QC	HOUSING ASSY; 150 SRS; 6 SPLINE QC SHFT	\$1,119.00
40357	BAC-15-150-A-M	HOUSING ASSY; 150 SRS; 21 SPLINE	\$1,217.00
40358	BAC-15-150-B-600	HOUSING ASSY; 150 SRS; 1" STUB; 600 RPM	\$1,222.50
40359	BAC-15-150-B-M	HOUSING ASSY; 150 SRS; 1" STUB; 1000RPM	\$1,216.00
40360	BAC-15-A-M	HOUSING ASSY; 21 SPLINE SHAFT	\$1,192.50
40361	BAC-14-750-HYD-A	FRAME; FMC-750-HYD; CI ALTERNATE DRILL	\$923.75
40362	BAC-15-AM-6SP	HOUSING ASSY; 6 SP SHAFT; 1000 RPM	\$1,082.25
40363	BAC-15-AM-6SPQC	HOUSING ASSY; 6 SPL QC SHAFT; 1000 RPM	\$1,088.00
40364	BAC-15-B-LESS PULLEY	HOUSING ASSY; LESS PULLEY	\$877.50
40365	BAC-12-150-EC	VOLUTE; 1-1/2" x 1-1/4"; ECOATED IRON	\$452.00
40366	BAC-14-150-HYD-EC	FRAME FOR HYD MOTOR; ECOAT; 150 SERIES	\$534.50
40367	BAC-14-HYD-EC	FRAME FOR 200 SERIES HYD MOTOR; E-COAT	\$453.25
40368	BAC-12-EC	VOLUTE; 1-1/4" x 1"; CAST IRON; E-COAT	\$367.00
40369	BAC-14-150-HYD-300A-EC	FRAME FOR 300A HYD MOTOR; ECOAT; 150 PUMP	\$577.75
40370	BAC-15-B	HOUSING WITH MOUNTING FEET	\$361.75
40371	BAC-14-150-F-EC	FRAME; ECOAT; 150 SERIES	\$460.75
40372	BAC-15-B-M	HOUSING ASSY; 1" STUB; 1000 RPM	\$1,301.75
40373	BAC-15-B-A-600	HOUSING ASSY; 1" STUB; 600 RPM	\$1,203.75
40375	BAC-14-205-HYD-EC	FRAME; 300A MOTOR; 203 BEARING; E-COAT	\$509.25
40376	BAC-14-HYD-300A-EC	FRAME; ECOAT; 300A SERIES MOTOR	\$491.75
40377	BAC-26-HYD-CI-EC	IMPELLER; KEYWAY; CAST IRON; E-COAT	\$315.50
40378	7AC-14-FLG-EC	VOLUTE; 300 x 220 FLG; CCW; IRON; ECOAT	\$583.25
40379	7AC-14-CCW-EC	VOLUTE; 2" x 1.5"; CCW; ECOATED	\$478.50
40380	BAC-14-150-MIA-EC	FRAME FOR IDLER ARM; ECOAT; 150 SERIES	\$460.75
40381	BAC-14-150-MAG-D	FRAME; 150 SERIES; W/ MOUNT FOR MAG-D	\$621.75
40383	BAC-14X-205-F	FRAME FOR X SERIES PUMP	\$441.00
40384	BAC-26-150-CI-EC	IMPELLER; KEYWAY; CAST IRON; E-COAT	\$326.25
40386	BAC-14X-205-F-A	FRAME FOR X SERIES PUMP	\$448.75
40391	BAC-23-A	NUT; 3/8" NF FLEX LOCK; CAD PLATED	\$2.75
40392	BAC-23-A-SS	NUT; 3/8" NF HEX; STAINLESS STEEL	\$10.75
40393	BAC-23-B-SS	NUT; 3/8" NF HEX; STAINLESS STEEL	\$1.25
40397	40397	NUT; ACORN; 5/8-11; STAINLESS STEEL	\$17.50
40398	BAC-14-F-EC	FRAME; EC	\$369.25
40400	BAC-24-HYD-SS	WASHER; 3/8"; SS	\$1.75
40420	BACH-25	KEY FOR IMPELLER; 1/8" x 1/8" x 7/16" SS	\$1.25
40425	BAC-25	KEY FOR 2" IMPELLER; 1/8" x 1/8" x .825"	\$1.25
40430	BAC-26-VALOX	IMPELLER; VALOX; LEFT HAND THREAD	\$108.25
40432	BAC-26-CI	IMPELLER; CAST IRON; LH THREAD	\$244.75
40433	BAC-26-200-CI	IMPELLER; 5.5"DIA; CCW; KEYWAY; 2" PUMP	\$326.25
40434	BAC-26-200-P	IMPELLER; 5.5"DIA; CCW; KEYWAY; PLASTIC	\$156.50
40436	BAC-26-200-SS	IMPELLER; 5.5"DIA; CCW; 2" PUMP; 316 SS	\$445.50
40440	BAC-26-HYD-VALOX	IMPELLER; KEYWAY; VALOX	\$108.25

EDP	Part Number	Description	List Price
40442	BAC-26-HYD-CI	IMPELLER; KEYWAY; CAST IRON	\$251.50
40444	BAC-26-125-P	IMPELLER; KEYWAY; THERMOPLASTIC	\$128.00
40445	BAC-26-150-CI	IMPELLER; KEYWAY; CAST IRON	\$266.75
40446	BAC-26-150-P	IMPELLER; KEYWAY; THERMOPLASTIC	\$108.25
40448	BAC-26-150-PI	IMPELLER; KEYWAY; POLYPROPYLENE	\$113.50
40449	BAC-26-150-SS	IMPELLER; 5.5" DIA; CCW; 1.5" PUMP; 316 SS	\$426.75
40453	BAC-26-155-P	IMPELLER; KEYWAY; THERMOPLASTIC	\$138.75
40454	BAC-26-255-P	IMPELLER; KEYWAY; THERMOPLASTIC	\$138.75
40520	BAC-27	DUST COVER FOR PTOC & PTOC-150	\$12.75
40610	BAC-28-10	BELT; 40"; 10 GROOVE (FOR PTOC-600)	\$68.50
40611	BAC-28-10-150	BELT; 44"; 10 GROOVE (FOR PTOC-150-600)	\$75.00
40620	BAC-28-10-M	BELT; 31"; 10 GROOVE (FOR PTOC-1000)	\$69.50
40621	BAC-28-10M-150	BELT; 36"; 10 GROOVE (FOR PTOC-150-1000)	\$76.25
40675	BAC-29-10-1.35	PULLEY; 1.35" PD x 5/8" BORE; 10 GROOVE	\$99.25
40680	BAC-29-10-1.5	PULLEY; 1.5" PD x 5/8" BORE; 10 GROOVE	\$99.25
40681	BAC-29-10-1.7	PULLEY; 1.7" PD x 5/8" BORE; 10 GROOVE	\$99.25
40740	BAC-30-10	PULLEY; 10.6" PD x 2" BORE; 10 GROOVE	\$326.25
40741	BAC-30-10-150	PULLEY; 11.6" PD x 2" BORE; 10 GROOVE	\$345.00
40745	BAC-30-175	PULLEY; 6.375" PD x 2.375" BORE; 10 GROOVE	\$338.50
40746	BAC-30-175-150	PULLEY; 7.9" PD x 2.375" BORE; 10 GROOVE	\$369.25
40750	BAC-30-10-M	PULLEY; 6.375" PD x 2" BORE; 10 GROOVE	\$314.00
40751	BAC-30-10-M-150	PULLEY; 7.9" PD x 2" BORE; 10 GROOVE	\$338.50
40781	BAC-31-1	BEARING; BAC-10 SHAFT	\$59.50
40782	BAC-31-RETRO	RETROFIT KIT; BAC-31 TO BAC-31-1	\$202.50
40790	BAC-32	SNAP RING FOR BAC-6 SHAFT	\$0.75
40792	BAC-32X	SNAP RING FOR BAC-6X SHAFT	\$1.25
40793	BAC-32-750	SPACER; BAC-6-750-HYD-SS-WS SHAFT	\$56.25
40794	BAC-32-650	SPACER FOR BAC-6-650-SS SHAFT	\$54.00
40795	BAC-32-S	SPACER FOR BAC-6 SHAFT	\$7.00
40796	BAC-32X-S	SPACER FOR BAC-6X SHAFT	\$37.50
40799	BAC-15-PIN	ALIGNMENT PIN FOR PTOC PUMPS	\$1.25
40802	BAC-32-650-WS	SPACER FOR BAC-6-650-HYD-SS-WS SHAFT	\$48.50
40810	BAC-33	SNAP RING; INTERNAL; BAC-14 FRAME	\$2.25
40812	BAC-33X	SNAP RING; INTERNAL; BAC-14X FRAME	\$3.75
40820	BACH-33	SNAP RING; INTERNAL	\$1.75
40830	BAC-34	SNAP RING; INTERNAL; BAC-15 HOUSING	\$6.00
40835	BACH-32-HD	SNAP RING; EXTERNAL; HEAVY DUTY	\$3.75
40840	BAC-35	SNAP RING; EXTERNAL; BAC-10 SHAFT	\$1.25
40850	BAC-36	SNAP RING; EXTERNAL; BAC-13 IDLER	\$2.25
40855	BAC-36X	SNAP RING; EXTERNAL; X SERIES PUMP	\$3.75
40870	BAC-37	BEARING; BAC-6 DRIVEN SHAFT	\$23.25
40872	BAC-37X	BEARING; BAC-6X DRIVEN SHAFT	\$34.75
40875	40875	BEARING; SEALED; 650 AND 750 SHAFT	\$51.75
40876	40876	BEARING; FRONT; BAC-6-850-HYD-SS SHAFT	\$51.75
40877	40877	BEARING; REAR; BAC-6-850-HYD-SS SHAFT	\$65.00
40880	40880	BEARING; SINGLE ROW	\$28.50
40905	BAC-38-1	SPACER FOR BAC-10 DRIVE SHAFT. L=1.5"	\$44.75
40907	BAC-38-R	SPACER FOR BAC-10 RETRO KIT; L=.31"	\$37.50
40930	40930	CAP SCREW; 3/8" NC x 3/4" HEX; SS	\$2.75
40932	40932	CAP SCREW; 3/8" NC x 1" HEX; SS	\$2.75
40940	BAC-40	SET SCREW; 3/8" NC SLOTTED	\$1.25
40950	40950	CAP SCREW; 3/8" NC x 3/4" HEX; BAC-39	\$0.75
40952	40952	CAP SCREW; 3/8" NC x 2-1/2" HEX	\$2.25
40953	40953	CAP SCREW; 3/8" NC x 2-1/4" HEX	\$2.25
40954	40954	CAP SCREW; 3/8"-16 x 1-1/4" HEX;	\$2.25
40960	40960	NUT; 3/8" NC JAM TYPE	\$0.75
40970	BAC-42	CAP SCREW; HEX HD 3/8"-16 X 2" GRADE 5	\$1.75
40980	BAC-43	WASHER; 5/16" FLAT	\$0.60
40990	BAC-44	3/8" LOCK WASHER	\$0.60
41010	BAC-45	NUT; 3/8" NC HEX	\$0.60
41020	BAC-46	SPACER; 5/8"	\$35.25
41040	BAC-47	CAP SCREW; 5/8" NC x 2-1/4" HEX HEAD	\$9.50
41070	BAC-49	RETAINER RING	\$0.75
41079	41079	KEY; 3/16" x 3/16" x 1/2" FOR IMPELLER	\$1.25
41080	BAC-50	KEY; 3/16" x 3/16" x 1-1/4"	\$1.75
41081	41081	KEY; 3/16" x 3/16" x .675"; FOR GE-660	\$1.25
41082	41082	KEY; 3/16" x 3/16" x 15/16"; FOR GE-75	\$1.25
41083	41083	KEY; .25 x .25 x .875; GE-860	\$1.25
41085	41085	KEY; .188 x .188 x .875; FMC-650	\$1.50
41088	41088	KEY; WOODRUFF #505	\$1.75
41090	BAC-51	KEY; 3/8" x 1/2" x 1-1/2"; PTO DRIVE SHA	\$6.75
41100	BAC-52	1/4" COLD SHUT; TORQUE CHAIN ANCHOR	\$5.00
41104	41104	PLUG; LOAD SENSE PORT 06 ORD	\$2.75
41105	41105	PIPE PLUG; 3/4" NPT; SQUARE SOCKET HEAD	\$4.75
41107	41107	BUSHING; SAE#8 X 1/4 FNPT; HEX ;W O-RING	\$14.25
41108	41108	PLUG; SAE #8; HEX HEAD; WITH O-RING	\$10.25
41109	BAC-53-P	PIPE PLUG; 1/8" NPT; PLASTIC	\$2.25
41110	BAC-53	PIPE PLUG; 1/8" NPT; HEX HEAD	\$0.65
41114	41114	PLUG; SAE #8; HEX HEAD; WITH O-RING SS	\$24.75
41120	41120	PIPE PLUG; 1/8" NPT; 18-8 SS	\$6.00
41122	41122	PIPE PLUG; FILL/DRAIN; 1/2" NPT; POLYPROPYLENE	\$13.75
41130	BAC-54	SLINGER; 1" OD X 9/16" ID X .125" THK	\$2.25
41132	BAC-54-650	SLINGER; 1.5" OD X 7/8" ID X .125" THK	\$6.00
41140	BAC-55	IDLER BEARING AND ROLLER ASSY	\$77.25
41150	BAC-55-A	IDLER ARM AND ROLLER ASSY	\$231.00
41180	BAC-57	SET SCREW; 5/16" NC x 5/16" ALLEN HEAD	\$1.00
41190	BAC-58	ZERK FITTING; 1/4" DRIVE-IN	\$3.75
41250	41250	CAP SCREW; 5/16" NC x 3-1/2" HEX HEAD	\$2.25
41251	41251	CAP SCREW; 5/16" NC x 2 1/4" SOCKET HEAD	\$2.25
41252	41252	CAP SCREW; 5/16" NC x 3-1/2" SOC HD; SS	\$3.75
41253	41253	CAP SCREW; 5/16" NC x 3-1/2" SOC HD; 204N	\$2.25
41254	41254	CAP SCREW; 5/16" NC x 4" SOC HD; 210N	\$2.25
41255	41255	CAP SCREW; 5/16" NC x 3-3/4" SOC HD; 206N	\$2.25
41256	41256	CAP SCREW; 5/16-18 X 3.5", SOCKET HEAD	\$2.25
41259	41259	CAP SCREW; 5/16" NC x 3-3/4" SOC HD; SS	\$3.75
41260	BAC-63	NUT; 5/16" NC SELF-LOCKING	\$1.00

FDP	Part Number	Description	List Price
41261	41261	CAP SCREW; 5/16"NC x 6" SOC HD; SS	\$3.75
41262	41262	CAP SCREW; 5/16" NC x 2" SOCKET HEAD	\$2.25
41263	41263	CAP SCREW; 5/16"NC x 5-1/2" SOC HD; SS	\$2.25
41264	41264	CAP SCREW; 5/16" NC x 1-3/4" SOCKET HEAD	\$2.25
41290	BAC-75-HYD-206-PRO5-PWM	MOTOR; 6.5 GPM HYD; PRO 5; W/ PWM VALVE	\$1,953.50
41300	41300	SET SCREW; 3/8" NC x 5/8" CONE POINT	\$1.00
41312	BAC-75-HYD-306	MOTOR; 16.5 GPM HYD; N SERIES	\$1,114.50
41313	BAC-75-HYD-206R-P	MOTOR; 206R-PWM; LESS MANIFOLD	\$723.00
41314	BAC-75-HYD-206R-PWM	MOTOR; 6.5 GPM HYD; W/ PWM VALVE	\$1,990.75
41316	41316	AIR VALVE; 1/4" NPT	\$17.25
41317	BAC-70	FITTING; 1/8"NPT; RELIEF FOR FMCL PUMPS	\$7.25
41318	BAC-75-HYD-306N	MOTOR; 16.5 GPM HYD; N SERIES	\$1,100.25
41319	BAC-75-HYD-206-PRO5-P	MOTOR; 206N5-PWM; LESS MANIFOLD	\$737.50
41320	41320	FITTING; ZERK; 1/8" NPT; FOR SEAL LUBE	\$2.75
41321	BAC-75-HYD-206P	MOTOR; 206-PWM; LESS MANIFOLD	\$723.00
41322	BAC-75-HYD-204-PRO5	MOTOR; 4 GPM HYD	\$816.00
41324	BAC-75-HYD-206-PWM	MOTOR; 6.5 GPM HYD; W/ PWM VALVE	\$1,953.50
41326	BAC-75-HYD-203N5-CD	MOTOR; 3 GPM HYD; 8 SAE; CD; BLACK	\$818.00
41326P	BAC-75-HYD-203N5-CD-BLK	OBS; MOTOR; 3 GPM HYD; 8 SAE; CD	\$818.00
41327	BAC-75-HYD-M16-PWM	MOTOR; HYDRAULIC; GEAR; 16 GPM PWM	\$2,649.25
41328	BAC-75-HYD-304P	MOTOR; 304-PWM; LESS MANIFOLD	\$1,100.25
41329	BAC-75-HYD-206-PRO5	MOTOR; 7 GPM HYD	\$816.00
41330	41330	CAP SCREW; 5/16"NC x 3/4"	\$0.75
41332	BAC-75-HYD-202N	MOTOR; 2 GPM HYD	\$789.25
41333	BAC-75-HYD-203N	MOTOR; 3 GPM HYD	\$789.25
41334	BAC-75-HYD-307B-CD	MOTOR; 18 GPM; #12 PORTS; #6 CASE DRAIN	\$1,162.00
41335	BAC-75-HYD-304N-CD	MOTOR; 11 GPM HYD; SAE PORTS; N SERIES	\$1,162.00
41336	BAC-75-HYD-M22-PWM	MOTOR; HYDRAULIC; GEAR; 18 GPM PWM	\$3,063.50
41338	BAC-75-HYD-204N-CD	MOTOR; 4 GPM HYD; 8SAE; CD	\$789.25
41339	BAC-75-HYD-203-8SAE-CD	MOTOR; 3 GPM HYD; 8 SAE; CD	\$818.00
41342	BAC-75-HYD-304S	MOTOR; 11 GPM HYD; SAE SIDE PORTS	\$967.00
41343	BAC-75-HYD-304N	MOTOR; 11 GPM HYD; SAE PORTS; N SERIES	\$1,100.25
41344	BAC-75-HYD-310N	MOTOR; HYD; SAE END PORTS	\$1,169.75
41345	BAC-75-HYD-306A-12SAE	MOTOR; 16.5 GPM HYD; #12 SAE PORTS	\$1,128.00
41348	BAC-75-HYD-304-PWM	MOTOR; 11 GPM HYD; W/ PWM VALVE	\$2,289.50
41349	BAC-75-HYD-M16-CDE	OBS; MOTOR; HYDRAULIC; CASE DRAIN; END PORTS	\$1,157.50
41352	BAC-75-HYD-M25-CD	MOTOR; HYDRAULIC; GEAR; 20 GPM CASE DRAIN	\$1,227.00
41353	BAC-75-HYD-M22-CD	MOTOR; HYDRAULIC; GEAR; 18 GPM CASE DRAIN	\$1,203.75
41355	BAC-75-HYD-M22	MOTOR; HYDRAULIC; GEAR; 18 GPM	\$1,193.00
41356	BAC-75-HYD-M25	MOTOR; HYDRAULIC; GEAR; 20 GPM	\$1,216.00
41357	BAC-75-HYD-M30	MOTOR; HYDRAULIC; GEAR	\$1,240.25
41358	BAC-75-HYD-M16-CD	MOTOR; HYDRAULIC; GEAR; CASE DRAIN	\$1,152.00
41359	BAC-75-HYD-M16	MOTOR; HYDRAULIC; GEAR	\$1,175.25
41361	RK-BAC-75-HYD-300	OBS; REPAIR KIT; 304 & 307 MOTOR-QUAD	\$121.50
41362	RK-BAC-75-HYD-300-L	REPAIR KIT ASSY; 300 HYD MOTOR; (LIP SEA	\$121.50
41367	BAC-75-HYD-203	MOTOR; 3 GPM HYD	\$809.00
41368	BAC-75-HYD-202	MOTOR; 2 GPM HYD	\$809.00
41370	BAC-75-HYD-204	MOTOR; 4 GPM HYD	\$742.00
41371	RK-BAC-75-HYD	OBS; REPAIR KIT ASSY; 200 HYD MOTOR-QUAD	\$121.50
41372	BAC-75-HYD-206	MOTOR; 7 GPM HYD	\$742.00
41374	RK-BAC-75-HYD-L	REPAIR KIT ASSY; 200 SERIES HYD MOTOR (L	\$72.25
41375	BAC-75-HYD-210	MOTOR; 10 GPM HYD	\$785.00
41377	BAC-75-HYD-206-CD	MOTOR; 7 GPM HYD; CASE DRAIN; W FITTINGS	\$789.25
41378	BAC-75-HYD-310	MOTOR; 16 GPM HYD; 1/2 NPT; N SERIES	\$1,169.75
41379	RK-BAC-75-HYD-310	OBS; REPAIR KIT 310 HYD MOTOR-QUAD RING	\$121.50
41380	BAC-76-HYD	COUPLING FOR HYD MOTOR	\$34.00
41381	BAC-75-HYD-304	MOTOR; 11 GPM HYD; N SERIES	\$1,114.50
41382	BAC-75-HYD-307	MOTOR; 19 GPM HYD; #12 SAE PORTS	\$1,128.00
41385	BAC-75-HYD-305-12SAE	MOTOR; 15 GPM HYD; #12 SAE PORTS	\$1,128.00
41386	BAC-75-HYD-307A-CD	MOTOR; 18 GPM; #12 PORTS; #6 CASE DRAIN	\$1,162.00
41390	BAC-79-204-3/8" NPT	ORIFICE; 3/8" NPT MALE x 3/8" NPT FEMALE	\$35.25
41393	BAC-79-204-8SAE	ORIFICE; #8SAE x #8SAE	\$47.25
41394	BAC-79-206/210-8SAE	ORIFICE; #8 SAE x #8SAE WITH O-RING	\$47.25
41395	BAC-79-206/210-3/8" NPT	ORIFICE; 3/8" NPT MALE x 3/8" NPT FEMALE	\$35.25
41397	BAC-75-HYD-206N	MOTOR; 7 GPM HYD	\$723.00
41398	BAC-75-HYD-206N-CD	MOTOR; 7 GPM HYD; CASE DRAIN	\$801.25
41399	BAC-79-304-1/2NPT	ORIFICE; 1/2" NPT MALE x 1/2" NPT FEMALE	\$47.25
41408	LS-206	OBS-FLOW LIMITER-206 HYD MOTOR-3/8"NPT	\$102.50
41409	LS-204	OBS FLOW LIMITER- 204 HYD MOTOR -3/8"NPT	\$102.50
41411	LS-210	OBS FLOW LIMITER; 210 HYD MOTOR;3/8"NPT	\$102.50
41413	LS-304	FLOW LIMITER FOR 304 HYD MOTOR	\$102.50
41415	BAC-79-206/210-3/4ORRB	ORIFICE; 3/8"NPT x 3/4"-16ORB	\$47.25
41417	LS-204N	FLOW LIMITER-204N HYD MOTOR-#8x1/2NPT	\$102.50
41418	LS-206N	FLOW LIMITER-206N HYD MOTOR-#8x1/2NPT	\$102.50
41423	LS-210N	FLOW LIMITER-210N HYD MOTOR;#8x1/2"NPT	\$102.50
41424	LS-206N-10X8SAE	FLOW LIMITER; 206N; 8MX10F SAE	\$102.50
41426	BAC-75-HYD-304A-12SAE	MOTOR; 11 GPM HYD; #12 SAE PORTS	\$1,114.50
41429	LS-304N	FLOW LIMITER FOR 304N HYD MOTOR	\$102.50
41433	BAC-75-HYD-204N	MOTOR; 4 GPM HYD	\$723.00
41434	BAC-75-HYD-210N	MOTOR; 10 GPM HYD	\$764.00
41437	BAC-75-HYD-204R	MOTOR; 4 GPM HYD; REVERSE ROTATION	\$789.25
41438	BAC-75-HYD-206R	MOTOR; 6 GPM HYD; REVERSE ROTATION	\$771.75
41439	BAC-75-HYD-210N-CD	MOTOR; 10 GPM HYD; CASE DRAIN	\$824.75
41441	BAC-78-8SAE	REVERSE CHECK ASSY; #8 SAE X 1/2" NPT	\$34.00
41442	BAC-78-10SAE	REVERSE CHECK ASSY; #10SAE X 1/2" NPT	\$36.50
41445	41445	O-RING FOR #10 SAE FITTING	\$1.25
41446	BAC-80-10SAE	BODY; RESTRICTOR ORIFICE; #10SAE X 1/2"	\$26.50
41447	BAC-79-8	ORIFICE; RESTRICTOR INSERT; .125	\$13.50
41448	41448	O-RING; RESTRICTOR INSERT	\$1.25
41450	BAC-81-QC	COLLAR; BALL RETAINER SLEEVE FOR QC	\$39.25
41454	41454	ADAPTER; #8SAE MALE X 3/8" NPT FEMALE	\$11.00
41455	BAC-80-8SAE	BODY; RESTRICTOR ORIFICE; #8 SAE X 1/2"	\$26.50
41456	BAC-79-7	ORIFICE; RESTRICTOR INSERT; .109	\$13.50
41457	BAC-79-5	ORIFICE; RESTRICTOR INSERT; .078	\$13.50
41460	BAC-82-QC	SPRING FOR QUICK COUPLER	\$14.25
41461	BAC-80-10X8SAE	BODY; RESTRICTOR ORIFICE; #8 X #10 SAE	\$26.50

FDP	Part Number	Description	List Price
41462	BAC-78-10X8SAE	REVERSE CHECK ASSY; #8 X #10 SAE	\$39.75
41463	BAC-78-8ORFSX8SAE	REVERSE CHECK ASSY; #8 SAE X #8 ORFS	\$151.75
41466	BAC-80-10X10SAE	BODY; RESTRICTOR ORIFICE: 10SAE X 10SAE	\$26.50
41467	BAC-78-10X10SAE	REVERSE CHECK ASSY; #10SAE X #10SAE	\$41.75
41470	BAC-83-QC	BALL FOR QUICK COUPLER	\$1.75
41472	41472	SEAL ASSY TOOL; FMC-CW-800	\$66.00
41473	41473	ADAPTER PLATE; DUAL CLUTCH; X SERIES	\$233.75
41474	41474	PLATE; CLUTCH ADAPTER; FMC-650-MAG-D	\$233.75
41481	41481	CLUTCH ASSY; DUAL PULLEY; TAPER BORE 800	\$977.75
41482	41482	PULLEY; DUAL GROOVE; 58 FT-LB; TAPER BORE	\$897.25
41483	41483	SNAP RING; ADAPTER PLATE; FMCCW800MAGD	\$6.00
41484	41484	ADAPTER PLATE; DUAL CLUTCH; CW-800	\$270.25
41491	41491	ADAPTER PLATE; DUAL CLUTCH;	\$242.50
41492	41492	SPACER; DUAL CLUTCH; .623" LENGTH	\$26.50
41493	41493	CLUTCH ASSY; DUAL PULLEY; 58 FT-LB TORQUE	\$803.75
41494	41494	WASHER; 3/4" OD X 1 1/32" ID X 1/8" THICK	\$3.75
41496	41496	COIL; DUAL PULLEY; 58 FT-LB TORQUE	\$402.50
41497	41497	PULLEY; DUAL GROOVE; 58 FT-LB CLUTCH	\$661.50
41500	BAC-6-CW-SS	SHAFT; 5/8"DIA; RH FINE THREAD; SS	\$176.25
41501	BAC-6-CW-D-SS	SHAFT; 5/8"DIA; RH THREAD; 5/16" HOLE; SS	\$194.00
41504	BAC-6X-CW-SS	SHAFT; 3/4"DIA; RH FINE THREAD; SS	\$270.25
41505	BACL-6-CW-SS	SHAFT; 5/8"DIA; RH FINE THREAD; LIP; SS	\$169.75
41507	BAC-6X-CW-D-SS	SHAFT; 5/8"DIA; RH THREAD; MAG-D; SS	\$270.25
41509	BAC-6X-SS	SHAFT; 3/4"DIA; LH COARSE THREAD; SS	\$270.25
41510	BAC-26-CW-150-P	IMPELLER; 5.5"DIA; RH THREAD; PLASTIC	\$108.25
41515	BAC-26-CW-150-CI	IMPELLER; 5.5"DIA; RH THREAD; IRON	\$244.75
41516	BAC-6X-205-CW-SS	SHAFT; 3/4"DIA; RH FINE THREAD; SS	\$270.25
41517	BAC-6X-D-SS	SHAFT; 5/8"DIA; LH THREAD; MAG-D; SS	\$270.25
41520	BAC-26-CW-200-CI	IMPELLER; 5.125"DIA; RH THREAD; IRON	\$326.25
41523	BAC-26-CW-200-P	IMPELLER; 5.5"DIA; RH THREAD; PLASTIC	\$162.00
41524	BAC-6X-205-SS	SHAFT; 3/4"DIA; KEYED; SS	\$270.25
41525	BAC-26-HYD-200-CI	IMPELLER; 5.5"DIA; KW; CI; (OBS. 1/99)	\$326.25
41526	7AC-14-CCW	VOLUTE; 2" x 1.5"; CCW; IRON	\$418.75
41528	FLG3X2	FLANGE; 3.00 X 2.00 NPT	\$144.25
41529	41529	GASKET FOR FLG3X2; EPDM	\$7.75
41530	7AC-14-FLG	VOLUTE; 300 x 220 FLANGED; CCW; IRON	\$523.75
41531	7AC-14-CCW-SS	VOLUTE; 2" x 1.5"; CCW; 316 SS	\$879.75
41532	7AC-14-FLG-SS	VOLUTE; 2" x 1.5"; FLANGED; STAINLESS STEEL	\$1,021.75
41535	7AC-14-FLG-A	VOLUTE; 300 x 200; FLANGED; CCW; IRON	\$585.25
41581	BAC-6-125-HYD-SS-WS	SHAFT; 17MM DIA; KEYWAY; TANG SLOT; SS	\$233.75
41582	BAC-6-125-HYD-SS	SHAFT; 17MM DIA; KEYWAY; TANG SLOT; SS	\$169.75
41584	BAC-6-255-HYD-SS	SHAFT; 17MM DIA; KEYWAY; TANG SLOT; SS	\$239.25
41585	BAC-6-125-SS	SHAFT; 17MM DIA; KEYWAY; BELT DRIVE; SS	\$176.25
41653	BGKB-1	BELT GUARD; LEFT HALF; PTOC	\$79.25
41654	BGKB-2	BELT GUARD; RIGHT HALF; PTOC	\$79.25
41660	BGK-101	WASHER; 1/4" x 1-1/2" x 2"; RECTANGLE	\$9.25
41661	BGK-101-1	NUT; 1/4" x 1 1/2" x 3 1/2"; RECTANGLE	\$11.75
41695	BGK-104-1	NUT; 1/4" WING NUT	\$0.75
41705	BGK-105-1	CAP SCREW; 5/16"NC x 2-1/4" HEX	\$1.75
41715	BGK-106-1	BOLT; 1/4"NC x 3/4"	\$0.70
41718	41718	HOUSING (FOR 202 MOTOR)	\$205.25
41719	41719	HOUSING (FOR 203 MOTOR)	\$205.25
41720	41720	HOUSING (FOR 204 MOTOR)	\$205.25
41721	41721	HOUSING (FOR 206 MOTOR)	\$205.25
41722	41722	HOUSING (FOR 207.5N MOTOR)	\$205.25
41725	41725	HOUSING (FOR 210 MOTOR)	\$217.00
41731	41731	DRIVE PLATE FOR 204; 206; AND 210 MOTOR	\$383.75
41732	41732	DRIVE PLATE; CASE DRAIN FOR 200 SERIES	\$442.00
41733	41733	DRIVE PLATE FOR 200R SERIES MOTORS	\$377.00
41735	41735	DRIVE PLATE; CASE DRAIN FOR 203-8SAE	\$431.00
41736	41736	DRIVE PLATE ASSY FOR 200N5 MOTOR	\$377.00
41737	41737	DRIVE PLATE ASSY FOR 200N5-CD MOTOR	\$413.50
41740	41740	END PLATE; 200 SERIES	\$350.50
41741	41741	END PLATE; 200 SERIES #8 SAE SIDE PORTS	\$361.75
41742	41742	END PLATE; 200N SERIES MOTOR	\$350.50
41743	41743	END PLATE; 200R SERIES	\$350.50
41744	41744	END PLATE; 207.5N SERIES MOTOR	\$350.50
41746	41746	END PLATE; 200-PWM SERIES MOTOR	\$350.50
41747	41747	END PLATE; 200N5 SERIES MOTOR	\$350.50
41748	41748	GEAR FOR 202 MOTOR	\$138.75
41749	41749	GEAR FOR 203 MOTOR	\$138.75
41750	41750	GEAR FOR 204 MOTOR	\$138.75
41751	41751	GEAR FOR 206 MOTOR	\$138.75
41752	41752	GEAR FOR 207.5N MOTOR	\$151.00
41753	41753	GEAR FOR 207N MOTOR	\$151.00
41755	41755	GEAR FOR 210 MOTOR	\$151.00
41757	41757	DRIVE SHAFT FOR 203N MOTOR	\$118.00
41758	41758	DRIVE SHAFT FOR 202 MOTOR; 2.53" LONG	\$125.50
41759	41759	DRIVE SHAFT FOR 203 MOTOR; 2.62" LONG	\$125.50
41761	41761	DRIVE SHAFT FOR 204 MOTOR	\$125.50
41762	41762	DRIVE SHAFT FOR 207FB MOTOR	\$144.25
41763	41763	DRIVE SHAFT FOR 207.5N MOTOR	\$150.00
41764	41764	DRIVE SHAFT FOR 206 MOTOR	\$137.75
41766	41766	DRIVE SHAFT FOR 210 MOTOR	\$150.00
41770	41770	STEEL SEAL RETAINER; HYDRAULIC SEAL	\$29.75
41771	41771	END PLATE; 200R-PWM SERIES MOTOR	\$350.50
41780	41780	SPRING; REVERSE FLOW CHECK	\$2.25
41790	41790	CHECK VALVE CAP	\$40.75
41799	41799	DOWEL PIN FOR 202 & 203 MOTOR	\$3.75
41800	41800	DOWEL PIN FOR 204 MOTOR	\$3.75
41801	41801	DOWEL PIN FOR 206 MOTOR	\$5.00
41805	41805	DOWEL PIN FOR 206/210 MOTOR	\$5.00
41810	41810	STEEL BACK-UP WASHER	\$5.00
41820	41820	WASHER; NYLON	\$2.25
41830	41830	WIRE RING BEARING SPACER	\$3.75
41840	41840	COLLAR FOR QUAD RING SHAFT SEAL	\$6.25

FDP	Part Number	Description	List Price
41850	41850	O-RING; HOUSING SEAL	\$2.25
41860	41860	O-RING	\$2.25
41865	41865	O-RING; 1.375 I.D.; GE-860 KS	\$2.25
41870	41870	O-RING	\$2.25
41875	41875	O-RING FOR #8 SAE RESTRICTOR ORIFICE	\$1.25
41880	41880	QUAD RING SHAFT SEAL	\$7.25
41890	41890	RETAINING RING; INTERNAL; SHAFT SEAL	\$1.25
41899	41899	CAP SCREW; 1/4"NC HEX; 202/203	\$2.25
41900	41900	CAP SCREW; 1/4"NC x 1.5" HEX; 204/206	\$2.25
41905	41905	CAP SCREW; 1/4"NC x 2" HEX; 210	\$2.25
41907	41907	CAP SCREW; 3/8"NC x 1"; SOCKET HEAD; SS	\$3.75
41908	41908	CAP SCREW; 3/8"NCx 3/4"; SOCKET HEAD; SS	\$3.75
41918	41918	DOWEL PIN FOR 202 DRIVE SHAFT	\$2.25
41919	41919	DOWEL PIN FOR 203 DRIVE SHAFT	\$2.25
41920	41920	DOWEL PIN FOR 204 DRIVE SHAFT	\$2.25
41921	41921	DOWEL PIN FOR 206 DRIVE SHAFT	\$2.25
41925	41925	DOWEL PIN FOR 210 DRIVE SHAFT	\$2.25
41940	41940	SNAP RING (FOR MOTORS TO S/N 200199)	\$2.00
41941	41941	SNAP RING	\$1.00
41942	41942	SNAP RING; ADAPTER PLATE; FMC-650-MAG-D	\$7.00
41943	41943	SNAP RING; INTERNAL FRAME; BAC-14-650	\$4.75
41945	41945	SNAP RING; EXTERNAL; BAC-6-850-HYD-SS	\$4.75
41950	41950	BALL; REVERSE FLOW CHECK	\$1.25
41961	41961	BEARING; 7/16" I D	\$53.00
41968	41968	IDLER SHAFT FOR 202 MOTOR	\$66.00
41969	41969	IDLER SHAFT FOR 203 MOTOR	\$66.00
41970	41970	IDLER SHAFT FOR 204 MOTOR	\$66.00
41971	41971	IDLER SHAFT FOR 206 MOTOR	\$66.00
41972	41972	IDLER SHAFT FOR 207.5N MOTOR	\$66.00
41973	41973	IDLER SHAFT FOR 207FB MOTOR	\$66.00
41975	41975	IDLER SHAFT FOR 210 MOTOR	\$66.00
41980	41980	RETAINING RING; EXTERNAL; IDLER SHAFT	\$2.25
41990	41990	BALL; 200 SER IDLER SHAFT	\$2.25
42010	42010	NEEDLE VALVE ADJUSTING SCREW	\$29.75
42030	42030	THREAD SEAL; #7500 3/8" NC	\$9.25
42040	42040	WASHER; FLAT STEEL BACK-UP	\$3.75
42041	42041	CHECK CAP; SEAL	\$23.25
42042	42042	SPRING FOR SEAL CHECK	\$2.25
42043	42043	BALL	\$2.25
42044	42044	O-RING	\$2.25
42055	42055	ENGINE; 3 HP; HONDA# GX100T2QA2; KEYED	\$1,937.00
42056	42056	ENGINE; 3 HP; HONDA# GX120UT2QA2; KEYED	\$1,813.50
42060	GE-1-A	ENGINE; 3-1/2 HP; B&S #83132-1036F1; TH	\$1,044.00
42061	42061	ENGINE; 5.5 HP B&S# 130632-00F1; KS; PS	\$1,436.50
42062	42062	ENGINE; 5.5 HP; HON#GX-160UT2QX2;KS PULL	\$2,024.00
42064	42064	ENGINE; 5.5 HP; HON# GX160UT2QXE2; ES-KS	\$2,976.50
42066	42066	ENGINE; 8 HP; HONDA #GX240UT2PA2; TH	\$3,191.50
42067	42067	ENGINE; 8 HP; HOND#GX240UT2QAE2; ES KS	\$3,941.00
42068	42068	ENGINE; 5.5 HP; HON# GX-160UT2TX2; TH	\$2,270.75
42069	42069	ENGINE; 5.5 HP; B&S#126332-0035; TH	\$1,663.50
42072	42072	ENGINE; 8 HP; HOND#GX240UT2QA2; KS	\$3,086.75
42073	42073	ENGINE; 16 HP B&S W/ MUFFLER	\$5,622.25
42075	42075	MUFFLER; FOR 16 HP B&S	\$1,135.50
42076	42076	ENGINE; 4.5 HP; KOHLER CH245-3152; KEYED	\$1,808.00
42105	GE-6-SS-A	SLEEVE FOR 1" SHAFT; STAINLESS; L=1.875	\$90.50
42108	42108	SLEEVE FOR GE-860; SS	\$160.00
42120	GE-7-V	SEAL; 1" TYPE 6; VITON	\$90.50
42132	GE-8-V-A	O-RING FOR GE-6-A-SS; VITON	\$3.75
42151	GE-9-A	BRACKET (FOR USE WITH GE-1-A ENGINE)	\$330.75
42151E	GE-9-A-EC	BRACKET; ECOAT; FOR GE-1-A ENGINE	\$391.25
42161	GE-26-A	IMPELLER; RH 5/8" THREAD; IRON;	\$257.00
42161E	GE-26-A-EC	IMPELLER; RH 5/8" THREAD; ECOAT IRON;	\$316.50
42200	GE-44	5/16" LOCK WASHER	\$1.25
42220	GE-54	SLINGER; 1.625" OD X 1" ID X .125" THK	\$5.25
42221	GE-55	SLINGER (FOR USE WITH GE-800)	\$7.50
42222	GE-54-660	SLINGER; 1.25" OD X .75" ID X .125" THK	\$7.25
42230	GE-60	CAP SCREW; 5/16" NF x 3/4"; GRADE 5	\$0.75
42235	GE-60-SS	CAP SCREW; 5/16" NF x 3/4"; SS	\$1.75
42236	42236	CAP SCREW; 5/16" NF x 1"; SS	\$2.25
42237	42237	CAP SCREW; 5/16"-18 x 1-3/8"; SP	\$2.25
42238	42238	CAP SCREW; 5/16" NF x 2-1/2"; SS	\$3.50
42239	42239	SCREW; #10 THREAD FORMING; FLAT HEAD; SS	\$1.25
42240	42240	CAP SCREW; 1/4"-28 x 1" HEX HD; 18-8 SS	\$3.75
42245	42245	CAP SCREW; M8 X 60; METRIC; SS	\$5.00
42255	SP-62	CAP SCREW; 5/16"NFx1"HEX HEAD	\$1.00
42270	42270	NUT; 5/16" NC HEX	\$0.75
42271	42271	NUT; 5/16"-18 HEX; 316SS	\$1.25
42700	GE-12-75	VOLUTE FOR GE-75; 3/4" x 1"; POLY	\$152.00
42701	42701	WASHER; 3/8" SAE; SS	\$0.75
42702	BAC-24-B-SS	WASHER; 3/8" SS VIBRATION PROOF	\$8.25
42708	GE-12-75SP	VOLUTE FOR GE-75; 3/4" x 1"; POLY; SELF-PRIMING	\$178.50
42710	GE-26-75	IMPELLER FOR GE-75; KEYWAY; POLY	\$71.75
42711	GE-26-85	IMPELLER FOR GE-85; KEYWAY; POLY	\$71.75
42720	GE-14-75	BRACKET FOR GE-75; POLY	\$161.00
42721	GE-14-85	BRACKET FOR GE-85; POLY	\$161.00
42725	GE-14-75SP	BRACKET FOR GE-75SP; POLY; SELF-PRIMING	\$166.50
42726	GE-14-85SP	BRACKET FOR GE-85SP; POLY; SELF-PRIMING	\$166.50
42730	BAC-7-75V	SEAL; 5/8" TYPE 68; VITON; FOR GE-75	\$57.25
42731	BAC-7SC-75V	SEAL ASSY; 5/8"; SILICON CARBIDE; VITON	\$184.00
42732	BAC-7-75E	SEAL; 5/8" TYPE 68; EPR; FOR GE-75	\$136.50
43000	43000	HOUSING (FOR 310 MOTOR)	\$241.50
43001	43001	HOUSING (FOR 307 MOTOR)	\$241.50
43005	43005	HOUSING (FOR 304 MOTOR)	\$218.50
43006	43006	HOUSING (FOR 305 MOTOR)	\$241.50
43007	43007	HOUSING (FOR 306 MOTOR)	\$241.50
43015	43015	DRIVE PLATE; 300 SERIES	\$394.75

EDP	Part Number	Description	List Price
43016	43016	DRIVE PLATE; 300A SERIES	\$418.75
43017	43017	DRIVE PLATE; 300A-CD SERIES	\$418.75
43018	43018	DRIVE PLATE; 300B-CD SERIES	\$418.75
43020	43020	END PLATE; 300 SERIES	\$387.00
43021	43021	END PLATE; 300A SERIES	\$387.00
43022	43022	END PLATE; 300N SERIES	\$387.00
43023	43023	END PLATE; 300-PWM SERIES	\$423.25
43025	43025	END PLATE; 300 SERIES WITH #12 SAE PORTS	\$387.00
43026	43026	END PLATE; 300N-CD SERIES	\$387.00
43031	43031	GEAR; 307	\$163.25
43035	43035	GEAR; 304	\$163.25
43036	43036	GEAR; 305	\$163.25
43037	43037	GEAR; 306	\$163.25
43039	43039	SHAFT; DRIVE; 310A MOTOR	\$258.00
43041	43041	SHAFT; DRIVE; 307 EXTENDED TANG	\$258.00
43043	43043	SHAFT; DRIVE; 307A MOTOR	\$252.50
43045	43045	DRIVE SHAFT 304 MOTOR - OLD STYLE	\$240.25
43046	43046	DRIVE SHAFT; 304A MOTOR	\$240.25
43047	43047	DRIVE SHAFT 306 MOTOR	\$240.25
43050	43050	RETAINER; HYD SEAL	\$40.75
43051	43051	RETAINER; HYD SEAL; 304	\$40.75
43055	43055	RETAINER; HYD SEAL	\$40.75
43056	43056	SPACER; SEAL/BEARING; 300A MOTOR	\$36.50
43060	43060	SPRING; REVERSE CHECK; 300 SERIES	\$9.50
43080	43080	DOWEL PIN; 310 MOTOR	\$2.25
43081	43081	DOWEL PIN; 307 MOTOR	\$2.25
43085	43085	DOWEL PIN; 304	\$2.25
43086	43086	DOWEL PIN; GEAR CASE; 305	\$2.25
43087	43087	DOWEL PIN; GEAR CASE; 306	\$2.25
43090	43090	WASHER; STEEL BACK-UP	\$14.25
43120	43120	COLLAR; FOR 310 QUAD RING SEAL; .8"OD	\$24.25
43125	43125	COLLAR; FOR 304 QUAD RING SEAL; .935"OD	\$18.75
43130	43130	O-RING; HOUSING SEAL; 300 SERIES MOTOR	\$2.25
43141	43141	O-RING; 304 SEAL RETAINER	\$2.25
43150	43150	O-RING; FOR SEAL COLLAR; 310 MOTOR	\$2.25
43151	43151	O-RING; FOR SEAL COLLAR; 304 MOTOR	\$2.25
43160	43160	QUAD RING SHAFT SEAL; 310 MOTOR	\$9.50
43161	43161	QUAD RING SHAFT SEAL; 304 MOTOR	\$9.50
43175	43175	RETAINING RING; 304 SHAFT SEAL (BAC-33)	\$1.25
43185	43185	CAP SCREW; 3/8"NC X 1 3/4"HEX; 304 MOTOR	\$2.50
43190	43190	DOWEL PIN; 310 DRIVE SHAFT	\$2.25
43191	43191	DOWEL PIN; 307 DRIVE SHAFT	\$2.25
43195	43195	DOWEL PIN; 304 DRIVE SHAFT	\$2.25
43196	43196	DOWEL PIN; 305 & 306 DRIVE SHAFT	\$2.25
43200	43200	SNAP RING; 310 MOTOR	\$7.25
43205	43205	SNAP RING; 300 SERIES MOTOR BEARING	\$7.25
43210	43210	PLUNGER; REVERSE CHECK; 300 SERIES	\$54.00
43220	43220	BEARING FOR 310 MOTOR WITH 1/2" SHAFT	\$66.00
43225	43225	BEARING; 300 SERIES MOTOR WITH 5/8" SHAF	\$47.25
43230	43230	IDLER SHAFT FOR 310 MOTOR	\$71.75
43231	43231	IDLER SHAFT FOR 307 MOTOR	\$71.75
43235	43235	IDLER SHAFT FOR 304 MOTOR	\$71.75
43236	43236	IDLER SHAFT FOR 305 MOTOR	\$71.75
43237	43237	IDLER SHAFT FOR 306 MOTOR	\$71.75
43240	43240	RETAINER RING; GEAR; 300 SERIES	\$1.25
43250	43250	BALL; IDLER SHAFT; 310 MOTOR	\$2.25
43255	43255	BALL; IDLER SHAFT; 304 MOTOR	\$2.25
43260	43260	NEEDLE VALVE ADJUSTING SCREW	\$54.00
43265	43265	NEEDLE ADJUSTING SCREW; 300A MOTOR	\$54.00
43266	43266	NEEDLE ADJUSTING SCREW; 300N MOTOR	\$54.00
43270	43270	NUT; HEX	\$3.75
43275	43275	CAP; NEEDLE VALVE; 300A MOTOR	\$6.00
43276	43276	O-RING; NEEDLE CAP; 300A & 300N MOTORS	\$1.75
43277	43277	CAP; NEEDLE VALVE; 300N MOTOR; W/O-RING	\$6.00
43290	43290	O-RING FOR CHECK VALVE CAP; 300 SRS	\$2.25
43291	43291	THREAD SEAL; 1/2"; 300 SERIES	\$14.25
43292	43292	WASHER; STEEL BACK-UP	\$2.25
43300	43300	PLUNGER; COASTING CHECK; 300 SERIES	\$14.25
43305	43305	SPRING; COASTING CHECK; 300 SERIES	\$16.75
43310	43310	O-RING; COASTING CHECK; 300 SERIES	\$1.25
43315	43315	VALVE CAP; COASTING CHECK; 300 SERIES	\$21.25
43401	43401	SNAP RING; SEAL; M SERIES; EFF. 6/15	\$1.75
43407	43407	SUPPORT RING; SHAFT SEAL; M-CD SERIES	\$9.50
43409	43409	SUPPORT RING; SEAL; M SERIES	\$29.50
43411	43411	SEAL FOR SHAFT; M-CD SERIES; VITON	\$51.75
43413	43413	SEAL; SHAFT; M SERIES; TEFLON EFF. 6/15	\$72.75
43414	43414	PAD; ABSORBENT; M SERIES; EFF. 6/15	\$5.75
43416	43416	INSTALLATION TOOL; SHAFT SEAL; M SERIES	\$22.00
43417	43417	DRIVE PLATE; FLANGE; M-CD SERIES	\$183.00
43419	43419	O-RING; FLANGE; M SERIES; EFF. 6/15	\$1.75
43420	43420	PIN; MOTOR ASSY; M SERIES	\$1.25
43425	43425	HOUSING SEAL; FRONT EXTERNAL; M SERIES	\$5.00
43430	43430	ANTI-EXTRUSION SEAL; M SERIES	\$3.75
43431	43431	ANTI-EXTRUSION SEAL; M-CD SERIES	\$3.75
43435	43435	COMPENSATION SEAL; M SERIES MOTOR	\$3.75
43436	43436	COMPENSATION SEAL; M-CD SERIES MOTOR	\$3.75
43440	43440	HOUSING SEAL; REAR EXTERNAL; M SERIES	\$36.50
43445	43445	CAP; COASTING CHECK; M SERIES MOTOR	\$27.50
43450	43450	O-RING; COASTING CHECK CAP; M SERIES	\$0.60
43455	43455	SPRING; COASTING CHECK; M SERIES MOTOR	\$1.25
43460	43460	BALL; COASTING CHECK; M SERIES MOTOR	\$1.25
43465	43465	END PLATE; M MOTORS; #10 SAE PORTS	\$323.00
43466	43466	END PLATE; M-CDE; #6 SAE CASE DRAIN	\$315.50
43467	43467	END PLATE; M-CD; #6 SAE CASE DRAIN	\$315.50
43470	43470	CAP SCREW; HEX HD; M16	\$5.00
43475	43472	CAP SCREW; HEX HD; M16-CD	\$5.00

EDP	Part Number	Description	List Price
43475	43475	CAP SCREW; HEX HD; M22 & M25	\$11.00
43476	43476	CAP SCREW; HEX HD; M22-PWM	\$11.00
43477	43477	CAP SCREW; HEX HD; M16-PWM	\$8.50
43480	43480	CAP SCREW; HEX HD; M30	\$24.50
44038	44038	OBsolete BUSHING; NPT; 1/2" M X 1/8" F	\$6.75
44039	44039	BUSHING; #8 SAE X 1/8" FNPT	\$35.25
44041	44041	BUSHING; EXPANDER 1/4" FNPT X 1/8" MNPT	\$13.75
44044	44044	TEE; RETURN 08-08-10 JIC	\$29.00
44045	44045	TEE; MALE RUN TEE	\$144.25
44046	44046	ELBOW; STREET 1/4" BRASS	\$19.75
44092	44092	ADAPTER; LOAD SENSE 06 ORB - JIC	\$2.75
44095	44095	ADAPTER; 1/2" MPT x 3/8" MPT HEX	\$16.75
44096	44096	ADAPTER; OUTLET 08 ORB - JIC	\$4.75
44098	44098	ADAPTER; INLET 10 ORB - JIC	\$6.00
45165	BACG-33	SNAP RING; INTERNAL FRAME (FMC-CW-800)	\$4.75
45191	BACG-44-A	WASHER; 9/16" LOCK TYPE; SS (FMC-CW-800)	\$50.75
45196	45196	NUT; 9/16"NF; STAINLESS	\$10.25
45259	BAC-16-750-SS	SEAL PLATE; FMC-750-HYD; STAINLESS STEEL	\$909.50
45262	BAC-16-650	OBsolete; SEAL PLATE; FMCWS-650; E-COATED; CI	\$518.25
45263	BAC-16-855	SEAL PLATE; FMC-855-HYD; CAST IRON	\$1,090.25
45264	BAC-16-750	SEAL PLATE; FMC-750-HYD; CAST IRON	\$551.25
45267	45267	SPACER; 750 SEAL PLATE	\$33.00
45269	BAC-16-RES	RESERVOIR; END CAP; CAST IRON	\$392.25
45270	BACG-90M	CARTRIDGE FOR MECHANICAL SEAL	\$143.25
45271	45271	TUBING; POLYCARBONATE 3"ODX2.75"IDX5"L	\$47.25
45272	45272	O-RING; END CAP; RESERVOIR	\$1.25
45273	45273	PRESSURE REGULATOR; 0-30 PSI	\$90.50
45274	45274	NIPPLE; 1/4" NPT CLOSE; STEEL	\$6.00
45276	45276	SWIVEL; 8 SAE MALE X 1/4" NPT FEMALE; ST	\$17.75
45277	45277	CAP SCREW; 1/4-20 UNC X 6.5"; HEX HEAD	\$3.75
45278	45278	HOSE BARB; PUSH LOC; 1/4" NPT X 1/4" HOS	\$10.75
45279	45279	HOSE; PUSH LOC; 1/4" BLACK	\$8.25
45281	OASIS-RES	EXTERNAL WET SEAL RESERVOIR	\$694.50
45282	BAC-16-650-A	SEAL PLATE; FMCWS-650; E-COATED; CI	\$518.25
45283	BAC-16-650-A-SS	SEAL PLATE; FMCWS-650; STAINLESS STEEL	\$854.25
45285	BAC-16	SEAL PLATE; NEXT GEN; E-COATED; CI	\$512.75
50150	50150	GAUGE; 1.5"DIA; 0-160 PSI; 1/4" BACK MT; WITH ADAPTER	\$29.75
50151	50151	GAUGE; 1.5"DIA; 0-160 PSI; 1/4" BACK MT; WITH ADAPTER	\$43.50
51150	RK-PTOC-600	REPAIR KIT ASSY	\$136.25
51155	RK-PTOC-150-600	REPAIR KIT ASSY	\$142.75
51156	RK-PTOCSC-150-600	REPAIR KIT ASSY; SEVERE DUTY SEAL	\$286.00
51250	RK-PTOC-1000	REPAIR KIT ASSY	\$137.25
51255	RK-PTOC-150-1000	REPAIR KIT ASSY	\$144.00
51900	RK-FMCL	REPAIR KIT ASSY	\$115.25
51905	RK-FMCL-T	REPAIR KIT ASSY; LIP SEAL; PTFE	\$207.75
52610	BGKB	BELT GUARD KIT	\$187.05
52611	BGKB-HDWR-KT	BELT GUARD KIT; HARDWARE	\$28.55
52700	RK-FMC	REPAIR KIT ASSY	\$69.50
52705	RK-FMCSC-205	REPAIR KIT ASSY	\$212.75
52706	RK-FMCSC	REPAIR KIT ASSY; SILICON CARBIDE SEAL	\$212.75
52707	RK-FMCSCCE	REPAIR KIT; SILICON CARBIDE SEAL; EDPM	\$309.25
52710	RK-FMC-150	REPAIR KIT ASSY	\$69.50
52711	RK-FMCSC-150	REPAIR KIT ASSY; SILICON CARBIDE SEAL	\$212.75
52713	RK-FMCSC-155	REPAIR KIT; SILICON CARBIDE SEAL FOR 155	\$212.75
52715	RK-FMC-CW-800	REPAIR KIT ASSY	\$162.00
52716	RK-FMCSC-CW-800	REPAIR KIT ASSY; SILICON CARBIDE SEAL	\$371.75
52717	RK-FMCSC-PRO5	REPAIR KIT ASSY	\$220.25
52720	RK-FMC-650	REPAIR KIT ASSY	\$123.75
52721	RK-FMCSC-650	REPAIR KIT ASSY	\$248.50
52722	RK-FMCWS-650	REPAIR KIT ASSY; 650 WETSEAL MODELS	\$308.25
52723	RK-FMCWS-650-LF	REPAIR KIT ASSY; 650 WETSEAL MODELS	\$246.75
52724	RK-FMC-750	REPAIR KIT ASSY	\$411.75
52725	RK-FMC-850	REPAIR KIT ASSY	\$465.75
52726	RK-FMC-855	REPAIR KIT ASSY	\$536.50
52727	RK-FMC-750-LF	REPAIR KIT ASSY	\$288.75
52728	RK-FMCWS-PRO5	REPAIR KIT ASSY; PRO5 WETSEAL MODELS	\$300.50
52729	RK-FMCWS-650-CSC	REPAIR KIT ASSY; 650 WETSEAL MODELS	\$368.75
52731	RK-FMC-750-CSC	REPAIR KIT ASSY	\$151.50
52732	RK-FMCWS-650-CSC-LF	REPAIR KIT ASSY; 650 WETSEAL MODELS	\$307.25
52733	RK-FMC-750-CSC-LF	REPAIR KIT ASSY; 750 WETSEAL MODELS	\$28.50
55032	55032	BARRIER FLUID ASSY; QUART	\$61.50
55040	55040	BARRIER FLUID ASSY; CASE (12 QUARTS)	\$740.75
55850	55850	OBS; GAUGE; SIGHT; BRASS LIQUID LEVEL	\$53.00
55851	55851	GAUGE; SIGHT; STEEL; LIQUID LEVEL	\$55.00
60840	RK-GE-75	REPAIR KIT ASSY; GE-75	\$85.75
60841	RK-GESC-75	REPAIR KIT ASSY; GE-75; SILICON CARBIDE	\$212.50
60842	RK-FMC-75SP	REPAIR KIT ASSY; FMC-75SP	\$97.50
60843	RK-FMCSC-75SP	REPAIR KIT ASSY; FMCSC-75SP; SILICON CARBIDE	\$224.25
60844	RK-GE-85-IMP	REPAIR KIT ASSY; GE-85 WITH IMPELLER	\$172.00
60845	RK-GE-85	REPAIR KIT ASSY; GE-85	\$100.25
60846	RK-GESC-85	REPAIR KIT ASSY; GE-85; SILICON CARBIDE	\$255.50
60847	RK-GE-85SP	REPAIR KIT ASSY; GE-85SP	\$112.00
60848	RK-GESC-85SP	REPAIR KIT ASSY; GE-85SP; SILICON CARBIDE	\$267.25
60849	RK-GE-75-IMP	REPAIR KIT ASSY; GE-75 WITH IMPELLER	\$157.50
60851	RK-GESC-75-IMP	REPAIR KIT ASSY; GESC-75 WITH IMPELLER	\$285.00
60855	RK-GE-100-A	REPAIR KIT ASSY	\$102.75
61000	RK-GE-800/1600	REPAIR KIT ASSY	\$170.75
61005	RK-GE-800/1600-SG	REPAIR KIT ASSY; SILICON GRAPHITE SEAL	\$364.75
61010	RK-GE-860/1660	REPAIR KIT ASSY	\$188.25
61011	RK-GESG-860/1660	REPAIR KIT ASSY	\$341.25
61153	RK-GE-650	REPAIR KIT ASSY	\$103.50
61162	RK-GE-660	REPAIR KIT ASSY	\$92.25
61167	RK-GESC-660	REPAIR KIT ASSY SILICON CARBIDE SEAL	\$247.50
70060	70060	BALL; 1-1/4" SERIES 16	\$212.25
70190	70190	BALL; SERIES 16 1"	\$185.50
70250	70250	BALL; 303 SS; 2" SERIES 16	\$338.00

EDP	Part Number	Description	List Price
70290	70290	RATCHET; CARBON STEEL	\$278.50
70300	70300	PIN; PAWL; 303 SS	\$3.75
70310	70310	SPRING; FOR PAWL; 303 SS	\$1.25
70370	70370	BALL; 303 SS; 1-1/2" SERIES 16	\$278.50
70610	70610	SLEEVE; PIN; SS	\$12.50
70620	70620	HANDLE; 1/4 TURN; 3" SERIES 16	\$66.25
70720	70720	VALVTEC SERIES 16 1/2" & 3/4" BALLS	\$139.25
70730	70730	STEM; 1/4 TURN; 1/2" & 3/4" SERIES 16	\$120.00
70740	70740	BODY; TOP; BRONZE; 3/4" SERIES 16	\$293.25
70750	70750	BODY; TOP; ALUMINUM; 3/4" SERIES 16	\$238.25
70760	70760	BODY; TOP; IRON; 3/4" SERIES 16	\$225.75
70780	70780	BODY; TOP; BRONZE; 1/2" SERIES 16	\$271.75
70790	70790	BODY; TOP; ALUMINUM; 1/2" SERIES 16	\$238.25
70800	70800	BODY; TOP; IRON; 1/2" SERIES 16	\$212.25
70840	70840	BODY; TOP; IRON; 1-1/2" SERIES 16	\$245.00
70880	70880	BODY; BOTTOM; IRON; 1-1/2" SERIES 16	\$225.75
70900	70900	BODY; BOTTOM; BRONZE; 1/2" SERIES 16	\$253.75
70910	70910	BODY; BOTTOM; ALUMINUM; 1/2" SERIES 16	\$225.75
70920	70920	BODY; BOTTOM; IRON; 1/2" SERIES 16	\$206.75
70940	70940	BODY; BOTTOM; BRONZE; 3/4" SERIES 16	\$278.50
70950	70950	BODY; BOTTOM; ALUMINUM; 3/4" SERIES 16	\$232.50
70960	70960	BODY; BOTTOM; IRON; 3/4" SEREIS 16	\$212.25
70980	70980	PACKING; TEFLON; 1/2" AND 3/4" SERIES 16	\$32.50
70990	70990	SEAT; TEFLON; 1/2" AND 3/4" SERIES 16	\$36.00
71010	71010	BODY; TOP; ALUMINUM; 2" SERIES 16	\$298.75
71020	71020	BODY; TOP; IRON; 2" SERIES 16	\$266.25
71050	71050	BODY; BOTTOM; ALUMINUM; 2" SERIES 16	\$285.25
71060	71060	BODY; BOTTOM; IRON; 2" SERIES 16	\$245.00
71090	71090	PLATE; STOP; HANDLE; 1" AND 2" SERIES 16	\$20.25
71110	71110	O-RING; BODY SEAL; VITON; 1" SERIES 16	\$20.25
71170	71170	O-RING; SEAT; VITON; 1" SERIES 16	\$20.25
71200	71200	WASHER; THRUST; TEFLON; 1/2" & 3/4" SRS16	\$23.75
71210	71210	PLATE; STOP; HANDLE; 1/2" & 3/4" SRS 16	\$17.00
71220	71220	HANDLE; 1/4 TURN; 1/2 & 3/4" SERIES 16	\$66.25
71240	71240	BODY; TOP; ALUMINUM; 1-1/4" SERIES 16	\$266.25
71250	71250	BODY; TOP; IRON; 1-1/4" SERIES 16	\$232.50
71280	71280	BODY; BOTTOM; ALUMINUM; 1-1/4" SRS 16	\$253.75
71290	71290	BODY; BOTTOM; IRON; 1-1/4" SERIES 16	\$219.00
71320	71320	HANDLE; RATCHET; WITH FLOW; SER 16	\$179.75
71360	71360	BUSHING; RATCHET; 1/2" & 3/4" SERIES 16	\$39.25
71390	71390	HANDLE; RATCHET; 1" -16 SERIES	\$199.00
71400	71400	HANDLE; RATCHET; CROSS FLOW; SRS 16	\$199.00
71480	71480	INDICATOR; FLOW	\$11.25
71520	71520	HANDLE; RATCHET; 1/2 - 3/4 16 SERIES	\$199.00
71530	71530	HANDLE; RATCHET; CROSS FLOW; SRS 16	\$199.00
71540	71540	BODY; TOP; BRONZE; 1" SERIES 16	\$305.50
71550	71550	BODY; TOP; ALUMINUM; 1" SERIES 16	\$253.75
71560	71560	BODY; TOP; IRON; 1" SERIES 16	\$225.75
71580	71580	BODY; BOTTOM; BRONZE; 1" SERIES 16	\$285.25
71590	71590	BODY; BOTTOM; ALUMINUM; 1" SEREIS 16	\$245.00
71600	71600	BODY; BOTTOM; IRON; 1" SERIES 16	\$212.25
71620	71620	STEM; RATCHET; 1/2" & 3/4" SERIES 16	\$125.75
71630	71630	SEAT; TEFLON; 1" SERIES 16	\$39.25
71640	71640	BODY; TOP; IRON; 3" SERIES 16	\$338.00
71660	71660	BODY; BOTTOM; IRON; 3" SERIES 16	\$324.50
71690	71690	BRACKET; SPRING; SERIES 16	\$6.75
71710	71710	BRACKET; SPRING; 2" SERIES 16	\$6.75
71730	71730	SPRING; HANDLE RETURN; SERIES 16	\$6.75
71740	71740	PACKING; STEM; TEFLON; SERIES 16	\$32.50
71750	71750	STEM; 1/4 TURN; 1" SERIES 16	\$125.75
71760	71760	STEM; 1/4 TURN; 1-1/2" SERIES 16	\$125.75
71850	71850	HANDLE; 1/4 TURN; 2" SERIES 16	\$86.50
72030	72030	WASHER; THRUST; DELRIN; 1" SERIES 16	\$32.50
72060	72060	GRIP; HANDLE; 1/2" & 1" SERIES 16	\$6.75
72310	72310	HANDLE; 1/4 TURN; 1" SERIES 16	\$66.25
72410	72410	STEM; RATCHET; 1" SERIES 16	\$125.75
72420	72420	STEM; RATCHET; 1-1/2" SERIES 16	\$139.25
72510	72510	BUSHING; STEM; RATCHET	\$27.00
72520	72520	SPRING; HANDLE RETURN; 2" SERIES 16	\$6.75
72610	72610	SEAT; TEFLON; 1 1/4" SERIES 16	\$59.50
72620	72620	SEAT; TEFLON; 1 1/2" SERIES 16	\$59.50
72630	72630	SEAT; TEFLON; 2" SERIES 16	\$86.50
72750	72750	O-RING; SEAT; BUNA N; 1" SERIES 16	\$3.75
72760	72760	BOLT; 5/16" x 5/8"; HEX HEAD; GRADE 5	\$2.25
72761	72761	BOLT; 5/16"-18 x 1-1/4"; HEX HEAD; 18-8SS	\$2.75
72762	72762	BOLT; 5/16"-18 x 1-1/4"; SOCKET HEAD; 18-8SS	\$2.75
72780	72780	NUT; STEM; 1/4 TURN; 1" SERIES 16	\$2.25
72820	72820	NUT; STEM; RATCHET; 1/2" TO 2" SERIES 16	\$2.25
72890	72890	CAP SCREW; 1/2" NC X 1" HEX	\$2.25
72900	72900	BOLT BODY; 1/4" X 5/8" HEX HEAD; GRADE 5	\$2.25
72990	72990	O-RING; 1.174" ID	\$3.75
73000	73000	O-RING; SEAT; BUNA N; 1-1/2" SERIES 16	\$3.75
73010	73010	O-RING; BUNA N	\$3.75
73020	73020	O-RING; BODY; BUNA N; 1/2" & 3/4" SERIES 16	\$3.75
73030	73030	O-RING SEAL; BODY; BUNA N; 1" SERIES 16	\$3.75
73040	73040	O-RING; BUNA N; 1 1/4" SER 16	\$3.75
73050	73050	O-RING; BUNA N; 1 1/2" SER 16	\$3.75
73070	73070	O-RING SEAL; BODY; BUNA N; 2" SERIES 16	\$7.75
74005	DPK-1	MANIFOLD ASSEMBLY; FOR DPK KIT	\$2,315.00
74010	DPK-EXT	CABLE; 22' IMPLEMENT EXTENSION (OPTIONAL)	\$121.25
74015	DPK-2	SWITCH BOX ASSEMBLY WITH 15' CABLE	\$441.00
74020	DPK-3	CABLE; 12' IMPLEMENT	\$121.25
74025	DPK-18-MAN-7	VALVE; MANUAL FLOW CONTROL	\$573.25
74030	74030	COIL; 12V FOR DPK-18-MAN-7	\$167.50
74035	74035	NUT; SOLENOID	\$3.75
74040	DPK-18-PRO-7	VALVE ASSEMBLY; PROPORTIONAL	\$606.25

EDP	Part Number	Description	List Price
74045	74045	CONNECTOR; 2 PIN DEUTSCH W/ 8" PIG TAIL	\$10.75
74050	RK-DPK	SEAL KIT; MANIFOLD CARTRIDGE VALVES	\$134.25
74200	PWM-1	MANIFOLD; ASSEMBLY FOR 304-PWM	\$1,256.75
74201	PWM-1-206	MANIFOLD; ASSEMBLY FOR 206-PWM	\$1,256.75
74202	PWM-1-206R	MANIFOLD; ASSEMBLY FOR 206R-PWM	\$1,256.75
74205	74205	O-RING; PORT SEALING; MANIFOLD TO MOTOR	\$2.25
74209	74209	O-RING; PORT SEALING; MANIFOLD TO MOTOR	\$2.25
74210	PWM-18-PRV-11	VALVE; PRESSURE REDUCING	\$344.00
74220	PWM-18-PRO-11	VALVE ASSEMBLY;12V PROPORTIONAL	\$882.00
74222	PWM-18-PRO-6	VALVE ASSEMBLY;12V PROPORTIONAL	\$890.75
74224	PWM-18-PRO-18	VALVE ASSEMBLY;12V PROPORTIONAL	\$1,234.75
74225	74225	COIL; 12V FOR PWM-18-PRO-11	\$132.25
74226	74227	VALVE; CARTRIDGE LESS COIL	\$1,235.00
74226	PWM-18-PRO-20	VALVE ASSEMBLY;12V PROPORTIONAL BUCHER	\$1,234.75
74228	74228	COIL; 12V FOR PWM-18-PRO-20; BUCHER	\$177.50
74229	74229	COIL; 12V FOR PWM-18-PRO-18; HYDRAFORCE	\$88.25
74230	74230	NUT; COIL FOR PWM-18-PRO-11	\$33.50
74232	74232	NUT; COIL FOR PWM-18-PRO-20	\$11.75
74233	74233	NUT; COIL FOR PWM-18-PRO-18	\$11.75
74235	74235	PROTECTOR MANUAL OVERRIRID PWM-18-PRO-11	\$1.25
74240	74240	OVERRIDE; REPLACEMENT FOR PWM-18-PRO-6 OR -11	\$198.00
80250	80250	CAP SCREW; 3/8"-16 x 7/8" HEX	\$2.50
91350	RK-1606S	REPAIR KIT ASSY; VALVE 3/4"	\$132.00
91360	RK-1608S	REPAIR KIT ASSY; VALVE 1"	\$154.75
91370	RK-1610S	REPAIR KIT ASSY; VALVE	\$195.25
91380	RK-1612S	REPAIR KIT; VALVE	\$195.25
91390	RK-1616S	REPAIR KIT; VALVE	\$253.25

STANDARD WARRANTY

Ace pumps and valves are guaranteed against defects in material and workmanship for a period of one year from date of installation. Products or parts found to be defective upon inspection at the factory will be repaired or replaced at our discretion.

Ace Pump Corporation shall not be held liable for damages caused by abuse or misuse of the product or parts. No claim for labor in repairing or replacing such products will be allowed nor will loss of time or inconvenience be considered warranty obligations.

IMPORTANT: Pumps or valves returned for warranty consideration which are tested and found to perform within specifications are subject to an inspection charge.

PLEASE NOTE EXCEPTIONS

1. All seals are covered against defects in materials or workmanship. Seal failures resulting from application related conditions are not covered. Most seal failures are due to application conditions such as: (1) abrasive solution scratching the polished seal faces; (2) chemical attack on elastomers or glue; (3) thermal shock from running pump dry or improper priming; (4) failure to flush chemical from pump after use.
2. Gasoline engines are covered by the engine manufacturer's warranty. Engines submitted for warranty consideration should be returned to the nearest authorized engine repair station. **DO NOT RETURN ENGINE TO ACE PUMP CORPORATION.** If unable to locate nearest engine repair station, consult Ace for referral.
3. On Ace belt driven centrifugal pumps, belt alignment is not to be considered as covered by warranty. Misalignment can occur in transit and is easily corrected at point of installation.
4. Repair requests under the above categories will not be considered warranty, and current repair and transportation charges will apply.

PROCEDURE

To return pump, valve, or part for warranty consideration, please call Ace Pump at 901-948-8514 and request a Returned Goods Authorization (RGA) number. Please request one RGA number for each pump or valve. Provide the part number of the item being returned along with the reason for return. Be specific when describing the nature of the defect. Include this information in the box along with a customer contact name, phone number, and return address. Ship pump prepaid freight. Package pump in original packaging or similar to prevent damage in shipment. Warranty determinations will be made after the product has been received and inspected.

This warranty is in lieu of all other warranties, express or implied, and Ace Pump Corp. does not authorize any other person to assume for it any obligation or liability in connection with the sale of said pumps, valves, or any parts thereof.

WARNING: Pumps returned to Ace must be free of chemical hazard. Chemicals must be neutralized and thoroughly rinsed. Pumps with indications of active chemical will not be considered for repair or warranty.

MAKE SURE YOUR PUMP
HAS THE GUTS
TO GO THE DISTANCE

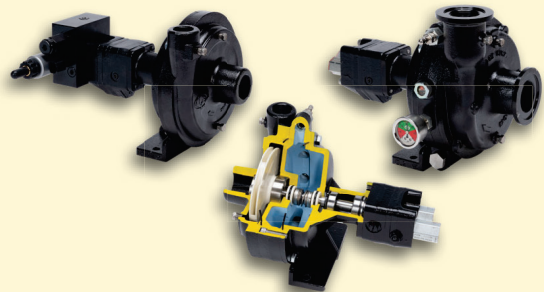

When you're racing against time and Mother Nature, the last thing you need is a pump that isn't up to the job. That's why it makes sense to put your trust in Ace Pro 5 Series pumps. Choose from Pro 5 FMCSC pumps with severe-duty silicon carbide seals, or Pro 5 FMCWS models with Ace Pump's exclusive Oasis™ WetSeal Technology. All Pro 5 pumps feature larger bearings for longer pump life. E-coated castings for added corrosion resistance. Standardized components for simplified inventory and maintenance. And optional motors with integrated PWM control valves for precision application. To learn more, visit www.acepumps.com.



ACE PUMP CORPORATION ♦ P.O. Box 13187 ♦ 1650 Channel Avenue ♦ Memphis, TN 38113
phone: 800-843-2293 ♦ fax: 901-774-6147 ♦ www.AcePumps.com

ACE FORM - PRICE LIST 2023