

A.R North America

Agriculture Catalog



**ANNOVI
REVERBERI**
The Power of Experience

2022

TABLE OF CONTENTS

AGRICULTURAL DIVISION

Annovi Reverberi manufactures diaphragm pumps for crop protection spraying applications. The best indication of our success is the trust that our many clients all over the world have placed in us. As the market for spraying pumps evolves, we are working on new pump models to further extend our already wide range.

With an annual production output of approximately 1,000,000 pumps Annovi Reverberi currently represents an ever-expanding concern with a strong presence in the Italian, European, and world markets with exports consisting of around 80% of overall turnover.

AR - a reliable partner which has always firmly believed in the importance of reciprocal collaboration and a relationship based on trust with its customers.

Medium Pressure Pumps	P 29 - 38
AR-DUE	29
AR252	30
AR30	31
AR40	32
AR50	33
AR303	34
AR403	34
AR503	35
AR1666 Gearbox	36
Application Kits Medium Pressure	37
Control Units Medium Pressure	38

Polypropylene Pumps	P 5 - 13
AR20FLP	5
AR25LFP	5
AR45LFP	6
AR60LFP	7
AR75LFP	8
AR80LFP	9
AR120LFP	10
AR140LFP	10
AR160LFP	11
AR185LFP	11
AR330LFP	12
AR380LFP	12
AR410LFP	13
AR460LFP	13

High Pressure Pumps	P 39 - 51
AR813	39
AR1053	40
AR1203	40
AR1064	41
AR1604	42
BHA130	43
BHA150	43
BHA170	44
BHA200	44
BHP130	45
BHP150	45
BHP170	46
BHP200	46
BHS90	47
BHS105	47
BHS120	47
BHS130	48
BHS150	48
BHS170	49
BHS200	49
Application Kits High Pressure	50
Control Units High Pressure	51

Low Pressure Pumps	P 5 - 28
AR45BP	14
AR70BP	15
AR80BP	16
AR115BP	17
AR135BP	17
AR115BP 1000	17
AR120BP	18
AR140BP	18
AR160BP	19
AR185BP	19
AR215BP	20
AR250BP	20
AR280BP	20
AR330BP	21
AR380BP	21
AR410BP	22
AR460BP	22
AR320BP Twin Top	23
AR370BP Twin Top	23
AR500BP Twin Top	24
AR560BP Twin Top	24
AR300MLC-C/C	25
Application Kits Low Pressure	26
Control Units Low Pressure	27 - 28

Accessories	P 52 - 102
Diaphragm Warranty	P 103
Triplex Plunger Pumps	P 104 - 107
Hydraulic Drive Pump Units	P 107 - 108
Accessories	P 109
Vacuum Pumps	P 110 - 116
Superex Clamps	P 117 - 122



Series LFP

Large capacity oil tank. Remote oil tank installation available.

Wide range of inlet and outlet fittings.

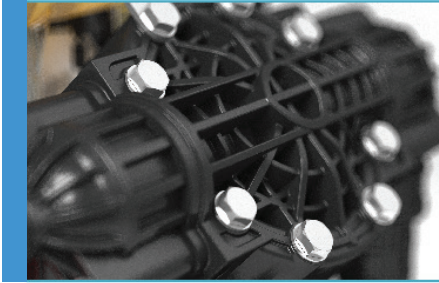

Pump head in nylon for aggressive chemicals.

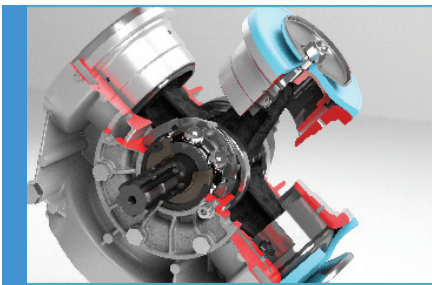

N°2 high quality needle bearings under the connecting rods to reduce friction.

Inlet and outlet manifolds are modular and position can be modified.

Version with Cardan / Cardan through shaft or female cylindrical shaft for direct mounting of hydraulic motors.

Double lip oil seals.

Drain plug to empty liquid from the circuit before winter storage.

Pump feet with Cataforesis protective treatment- Robust and fixed to the pump body.

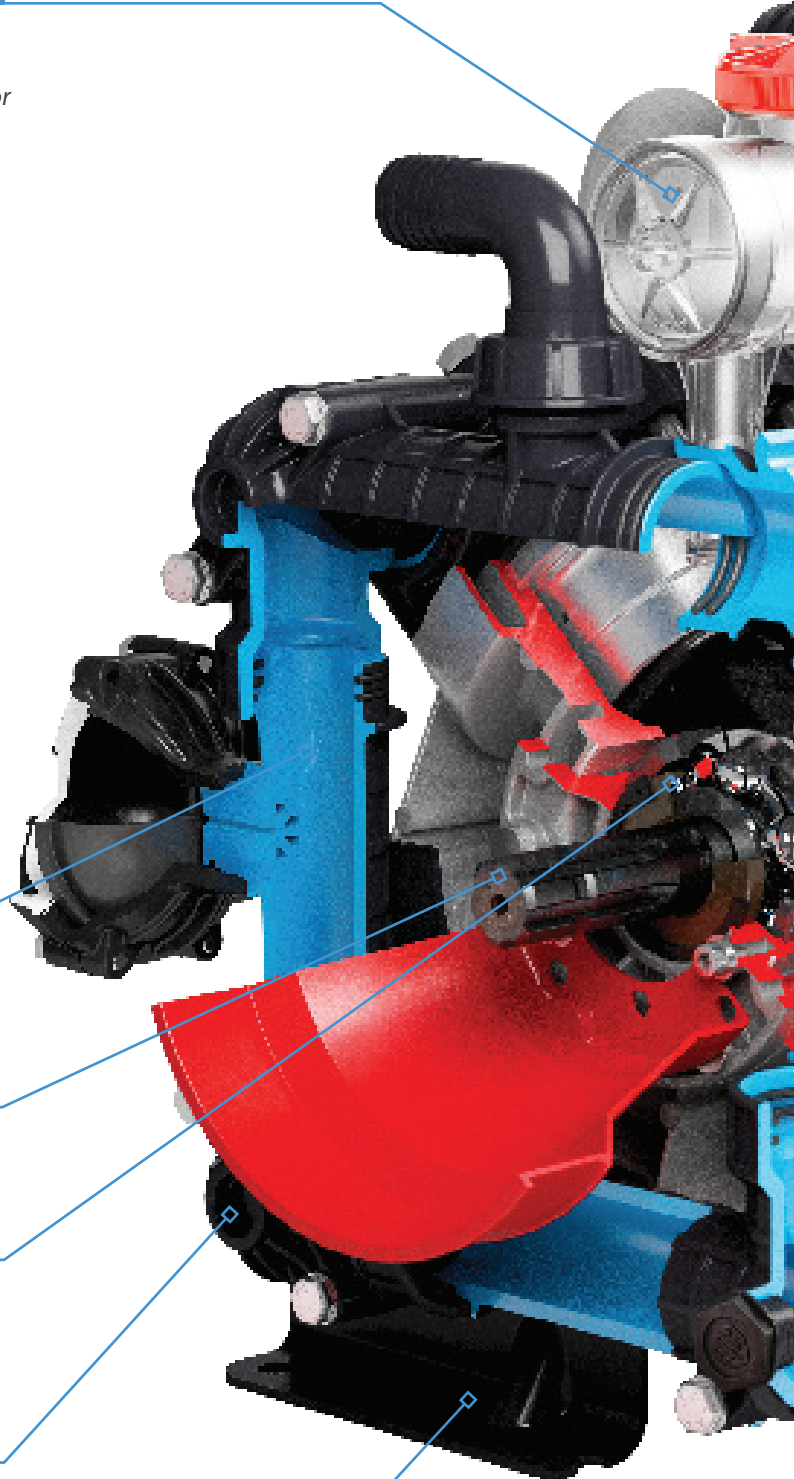

System to expel the air in the pump.

Attachment points for lifting.

Bolts and nuts for fixing the diaphragm in AISI 304.

GEOMET® bolts and nuts.

Large valves in AISI 304 for best hydraulic efficiency and better resistance to chemical agents.

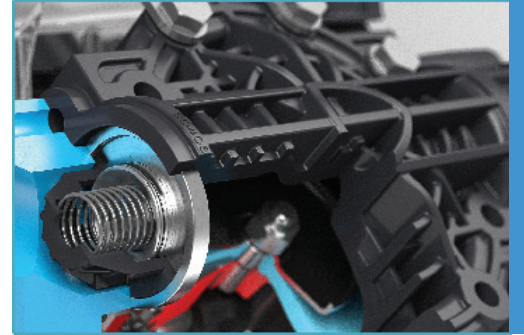

Long-life **BlueFlex™** diaphragms for resistance to spraying chemicals and aggressive liquid fertilizers.

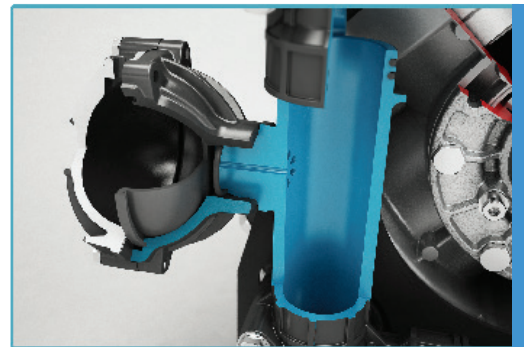

Reinforced plastic air chamber with **BlueFlex™** diaphragm.

Kit coupling flange and coupling for joining two pumps.

Flanges for connection to hydraulic motors and multipliers.

Manifolds with double O-ring in BUNA Rubber for aggressive chemicals.





New Pumps, Gearboxes & Accessories

NEW

Modular Diaphragm Pump 90-119 GPM.



Hydraulic flang mounting kits for most diaphragm pump models.

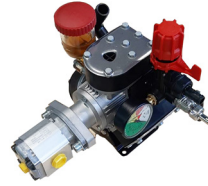

Nickel Plated AR1604 High Pressure Diaphragm Pump.



12VDC and 24VDC motor driven AR20LFP and AR25LFP pumps.



Heavy duty gearbox for medium pressure pumps, prevents engine shaft and key wear.



AR30 complete with GIC40 control and 230V single phase motor.

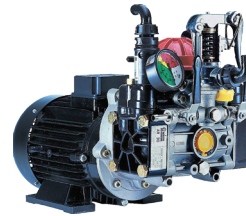

Hydraulic driven pressure washer complete with hose, gun, hi-lo nozzle and chemical injector.



Adjustable pattern spray guns are excellent for spraying lawns, turf and trees, using straight stream or wide angle spray pattern.



T-Shaped Spray Boom for trailed sprayers and ATV sprayers, for increased productivity.

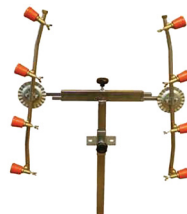

Heavy duty proportional valves for accurate precision spraying in demanding applications.



Series of manual sprayer controls for roller pumps, diaphragm pumps and centrifugal pumps

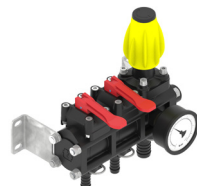

Modular boom control valves available with flow meters and proportional control valves





AR20LFP • AR25LFP

NEW

S e r i e s
P O L Y P R O P Y L E N E
L I Q U I D F E R T I L I Z E R P E S T I C I D E

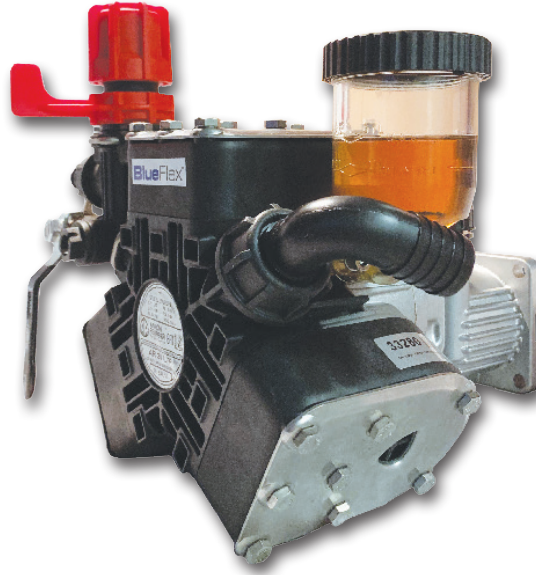

Low Pressure

140° F - Max Water Temp
 1" - Suction
 3/8" HB - Outlet

AR20LFP / AR25LFP - 1450 RPM - SEMI-HYDRAULIC THREE-DIAPHRAGM PUMP

MODEL	MAX GPM	MAX L/MIN	MAX PSI	MAX BAR	HP POWER	WEIGHT LBS.	LIST PRICE
AR20LFP-GR3/4-GCI	5.3	20.0	290	20	1.0	16	\$1,546.15
AR25LFP-GR3/4-GCI	6.4	24.3	290	20	1.1	16	\$1,597.51
AR20LFP-SP-GCI	5.3	20.0	290	20	1.0	15	\$1,332.15
AR25LFP-SP-GCI	6.4	24.3	290	20	1.1	15	\$1,358.90
AR20LFP-GCI-12VDC	5.3	20.0	200	13	0.7	45	\$2,804.26
AR25LFP-GCI-12VDC	6.4	24.3	150	10	0.7	45	\$2,867.60
AR20LFP-GCI-24VDC	5.3	20.0	200	13	0.7	45	\$2,804.26
AR25LFP-GCI-24VDC	6.4	24.3	150	10	0.7	45	\$2,867.60



12-24VDC Version.



Hydraulic Flange AR55387 (motor not included).

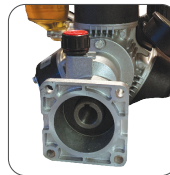

GR3/4-GCI Version.

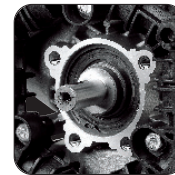

SP Version
 Straight 14 mm Keyed Shaft.

DIAPHRAGM KITS		
MODEL	DESCRIPTION	LIST PRICE
AR46561	BlueFlex™	\$77.61
AR46562	NBR	\$72.26
AR46563	Viton	\$364.80

VALVE KITS		
MODEL	DESCRIPTION	LIST PRICE
AR46564	Valves (AR20)	\$188.68
AR46565	Valves (AR25)	\$304.61

OIL		
MODEL	DESCRIPTION	LIST PRICE
AR64532D	Oil	\$16.59
AR64532D-C	Case (6)Oil	\$96.30



AR45LFP

S e r i e s
P O L Y P R O P Y L E N E
L I Q U I D F E R T I L I Z E R P E S T I C I D E

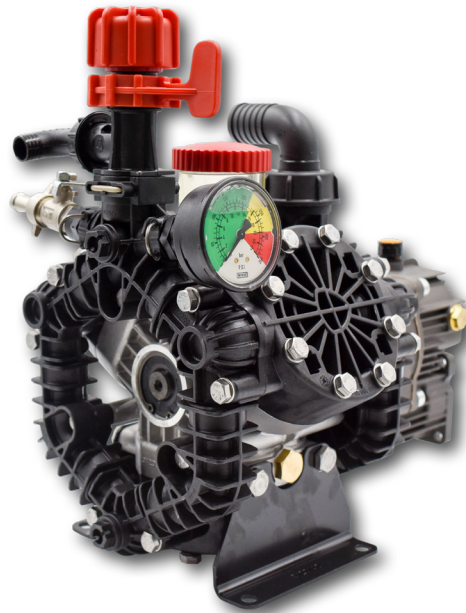

Low Pressure

140° F - Max Water Temp
1 1/4" - Inlet
1" - Outlet

AR45LFP - 550 RPM - SEMI-HYDRAULIC THREE-DIAPHRAGM PUMP

MODEL	MAX GPM	MAX L/MIN	MAX PSI	MAX BAR	HP POWER	WEIGHT LBS.	LIST PRICE
AR45LFP-C	11.4	43.3	290	20	2.1	29	\$1,305.40
AR45LFP-SP	11.4	43.3	290	20	2.1	28	\$1,267.95
AR45LFP-GR-GCI*	11.4	43.3	290	20	2.1	40	\$2,198.85
AR45LFP-GR	11.4	43.3	290	20	2.1	34	\$2,043.70

*Model comes standard with Viton diaphragms.

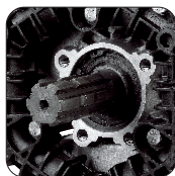

C Version
1 3/8" 6B Splined Shaft.



SP Version
Straight 3/4" Keyed Shaft.

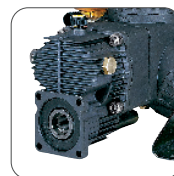

GR-GCI Version
Pump with Viton® Diaphragms and Gearbox AR31185 with 3/4" Hollow Shaft and GS25S Viton® Control Unit.



Hydraulic Flange AR55375.
For models AR45, AR60 & AR80 (SP Models Only). Fits SAE 2-bolt A Flange Motors with 1" Shaft.

DIAPHRAGM KITS			VALVE KITS			O-RING KITS			OIL		
MODEL	DESCRIPTION	LIST PRICE	MODEL	DESCRIPTION	LIST PRICE	MODEL	DESCRIPTION	LIST PRICE	MODEL	DESCRIPTION	LIST PRICE
AR43239	BlueFlex™	\$149.04	AR42816	Valves	\$217.96	AR43081	O-Rings	\$82.55	AR64532D	Oil	\$16.59
AR43237	Desmopan	\$130.72							AR64532D-C	Case (6)Oil	\$96.30
AR43236	NBR	\$102.88									
AR43238	Viton	\$443.18									



AR60LFP

S e r i e s
P O L Y P R O P Y L E N E
L I Q U I D F E R T I L I Z E R P E S T I C I D E

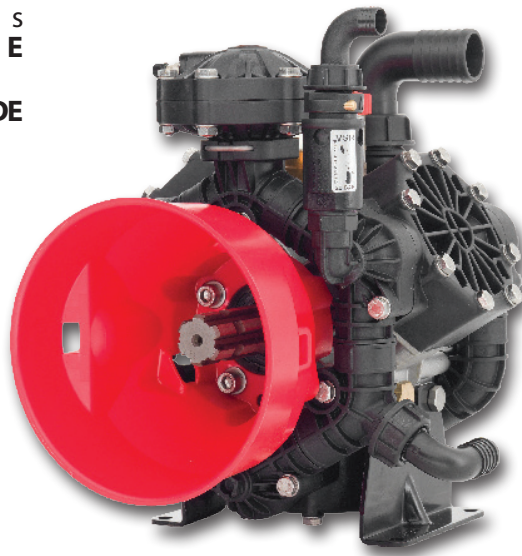

Low Pressure

140° F - Max Water Temp
 1-1/2" - Suction
 1" - Outlet

AR60LFP - 550 RPM - SEMI-HYDRAULIC THREE-DIAPHRAGM PUMP

MODEL	MAX GPM	MAX L/MIN	MAX PSI	MAX BAR	HP POWER	WEIGHT LBS.	LIST PRICE
AR60LFP-SP	15.6	59.1	290	20	2.14	31	\$1,444.50
AR60LFP-GR-GCI*	15.6	59.1	290	20	2.14	40	\$2,731.71

*Model comes standard with Viton diaphragms.



C Version
 1 3/8" 6B Splined Shaft.



SP Version
 Straight 3/4" Keyed Shaft.

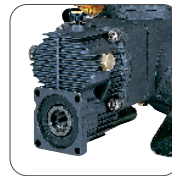

GR-GCI Version
 Pump with Viton® Diaphragms
 and Gearbox AR31185 with
 3/4" Hollow Shaft and GS25S
 Viton® Control Unit.



Hydraulic Flange AR55375.
 For models AR45, AR60 & AR80
 (SP Models Only). Fits SAE
 2-bolt A Flange Motors with
 1" Shaft.

DIAPHRAGM KITS			VALVE KITS			O-RING KITS			OIL		
MODEL	DESCRIPTION	LIST PRICE	MODEL	DESCRIPTION	LIST PRICE	MODEL	DESCRIPTION	LIST PRICE	MODEL	DESCRIPTION	LIST PRICE
AR43247	BlueFlex	\$142.52	AR43138	Valves	\$448.37	AR43128	O-Rings	\$137.00	AR64532D	Oil	\$16.59
AR43245	Desmopan	\$145.03							AR64532D-C	Case (6)Oil	\$96.30
AR43244	NBR	\$136.24									
AR43246	Viton	\$437.99									



AR75LFP



S e r i e s
N Y L O N
LIQUID FERTILIZER PESTICIDE

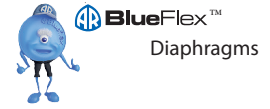
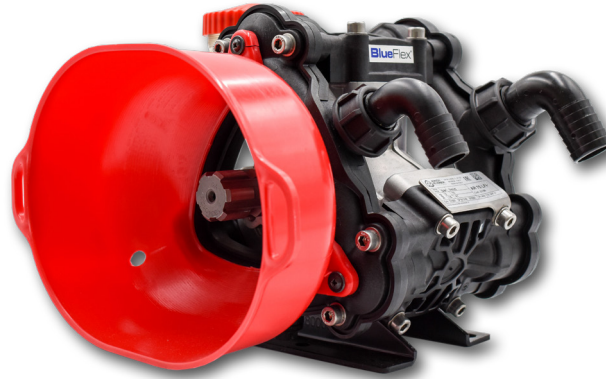

Low Pressure

140° F - Max Water Temp
1-1/4" - Hose Barb Inlet
1" - Hose Barb Outlet

AR75LFP - 550 RPM - SEMI-HYDRAULIC THREE-DIAPHRAGM PUMP

MODEL	MAX GPM	MAX L/MIN	MAX PSI	MAX BAR	HP POWER	WEIGHT LBS.	LIST PRICE
AR75LFP-SP	18.2	69	225	15	2.6	24	\$1,460.55
AR75LFP-C	18.2	69	225	15	2.6	27	\$1,130.99



C Version
1 3/8" 6B Splined Shaft.



SP Version
Straight 3/4" Keyed Shaft.



Hydraulic Flange AR55386.
For models AR75LFP
(SP Models Only). Fits SAE
2-bolt A Flange Motors
with 1" Shaft.

DIAPHRAGM KITS			VALVE KITS			O-RING KITS			OIL		
MODEL	DESCRIPTION	LIST PRICE	MODEL	DESCRIPTION	LIST PRICE	MODEL	DESCRIPTION	LIST PRICE	MODEL	DESCRIPTION	LIST PRICE
AR43080	BlueFlex	\$91.25	AR42816	Valves	\$217.96	AR46142	O-Rings	\$29.06	AR64532D	Oil	\$16.59
									AR64532D-C	Case (6)Oil	\$96.30



AR80LFP

Series
POLYPROPYLENE
LIQUID FERTILIZER PESTICIDE

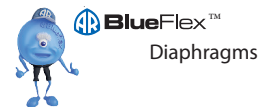
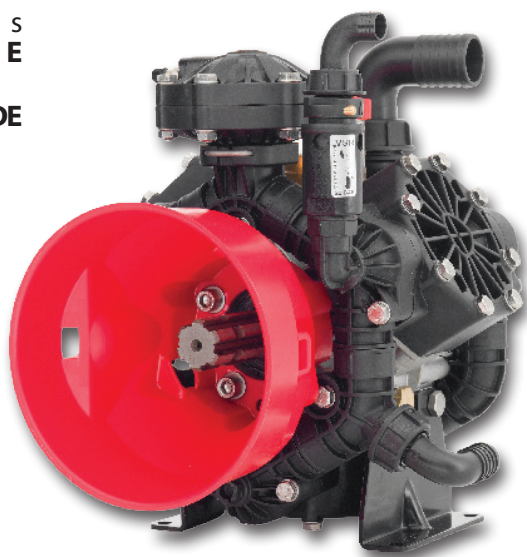

Low Pressure

140° F - Max Water Temp
 1-1/2" - Suction
 1" - Outlet

AR80LFP - 550 RPM - SEMI-HYDRAULIC THREE-DIAPHRAGM PUMP

MODEL	MAX GPM	MAX L/MIN	MAX PSI	MAX BAR	HP POWER	WEIGHT LBS.	LIST PRICE
AR80LFP-C	20.2	76.4	290	20	3.4	37	\$1,487.30
AR80LFP-SP	20.2	76.4	290	20	3.4	37	\$1,471.25
AR80LFP-AP-SP/C	20.2	76.4	290	20	3.4	40	\$1,567.55
AR80LFP-AP-C/C	20.2	76.4	290	20	3.4	40	\$1,599.65
AR80LFP-GR-GCI*	20.2	76.4	290	20	3.4	46	\$2,830.15

*Model comes standard with Viton diaphragms.



C Version
 1 3/8" 6B Splined Shaft.



SP Version
 Straight 3/4" Keyed Shaft.

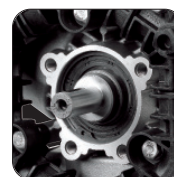

AP SP/C Version
 Straight 3/4" keyed x
 1 3/8 6B Splined Thru
 Shaft.



AP C/C Version
 1 3/8" 6B Splined
 Thru Shaft.

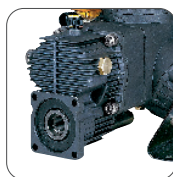

GR-GCI Version
 Pump with Viton®
 Diaphragms and Gearbox
 AR31185 with 3/4" Hollow
 Shaft and GS25S Viton®
 Control Unit.



Hydraulic Flange
 AR55375. For models
 AR45, AR60 & AR80
 (SP Models Only).
 Fits SAE 2-bolt A Flange
 Motors with 1" Shaft.

DIAPHRAGM KITS			VALVE KITS			O-RING KITS			OIL		
MODEL	DESCRIPTION	LIST PRICE	MODEL	DESCRIPTION	LIST PRICE	MODEL	DESCRIPTION	LIST PRICE	MODEL	DESCRIPTION	LIST PRICE
AR43247	BlueFlex™	\$142.52	AR43138	Valves	\$448.37	AR43128	O-Rings	\$137.00	AR64532D	Oil	\$16.59
AR43245	Desmopan	\$145.03							AR64532D-C	Case (6)Oil	\$96.30
AR43244	NBR	\$136.24									
AR43246	Viton	\$437.99									



AR120LFP • AR140LFP

S e r i e s
P O L Y P R O P Y L E N E
L I Q U I D F E R T I L I Z E R P E S T I C I D E

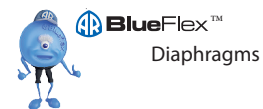
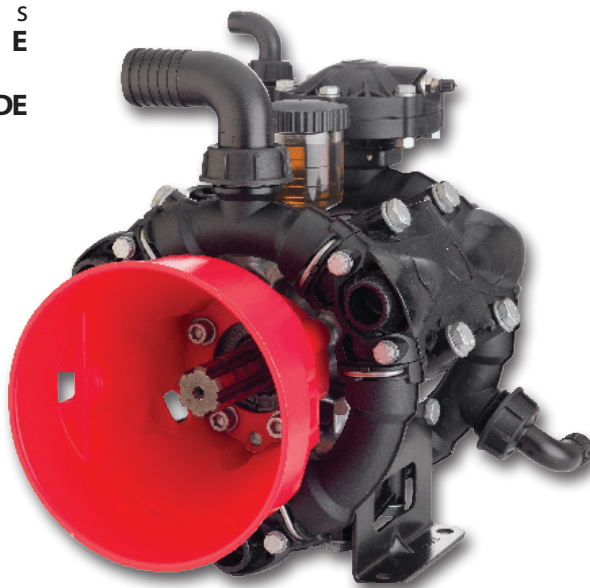

Low Pressure

140° F - Max Water Temp
1 1/2" - Suction
1" - Outlet

AR120LFP / AR140LFP - 550 RPM - SEMI-HYDRAULIC THREE-DIAPHRAGM PUMP

MODEL	MAX GPM	MAX L/MIN	MAX PSI	MAX BAR	HP POWER	WEIGHT LBS.	LIST PRICE
AR120LFP-C	30.8	116.7	220	15	4.5	41	\$1,979.50
AR120LFP-SP	30.8	116.7	220	15	4.5	39	\$1,931.35
AR120LFP-AP-SP/C	30.8	116.7	220	15	4.5	37	\$2,097.20
AR140LFP-C	35.1	132.9	220	15	5.2	41	\$2,033.00
AR140LFP-SP	35.1	132.9	220	15	5.2	39	\$1,984.85
AR140LFP-AP-SP/C	35.1	132.9	220	15	5.2	37	\$2,150.70

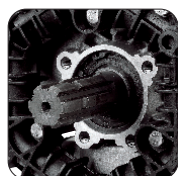

C Version
1 3/8" 6 Splined Shaft.



SP Version
Straight 25mm Keyed Shaft.



Hydraulic Flange Kit AR55376.
For models AR120, AR140 (SP Models Only). Fits SAE 2-bolt A Flange Motors with 1" Shaft.

DIAPHRAGM KITS			VALVE KITS			O-RING KITS			OIL		
MODEL	DESCRIPTION	LIST PRICE	MODEL	DESCRIPTION	LIST PRICE	MODEL	DESCRIPTION	LIST PRICE	MODEL	DESCRIPTION	LIST PRICE
AR43255	BlueFlex™	\$149.04	AR43138	Valves	\$448.37	AR43139	O-Rings	\$191.20	AR64532D	Oil	\$16.59
AR43253	Desmopan	\$148.05							AR64532D-C	Case (6)Oil	\$96.30
AR43252	NBR	\$150.05									
AR43254	Viton	\$1,144.17									



AR160LFP • AR185LFP

S e r r i e s
P O L Y P R O P Y L E N E
L I Q U I D F E R T I L I Z E R P E S T I C I D E

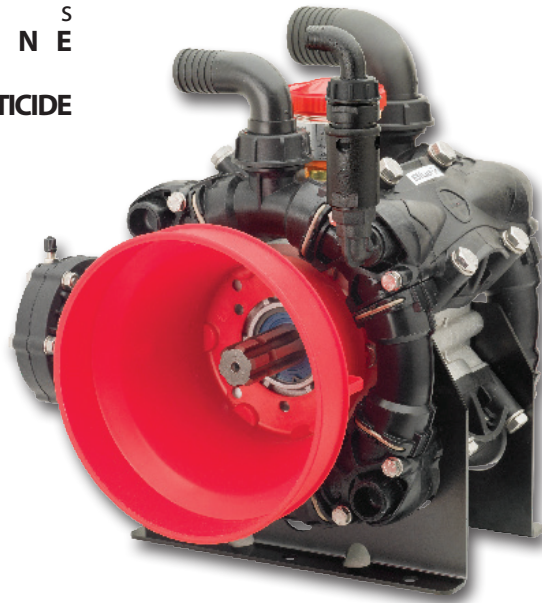

Low Pressure

140° F - Max Water Temp
 2" - Suction
 1-1/4" - Outlet

AR160LFP / AR185LFP - 550 RPM - SEMI-HYDRAULIC FOUR-DIAPHRAGM PUMP

MODEL	MAX GPM	MAX L/MIN	MAX PSI	MAX BAR	HP POWER	WEIGHT LBS.	LIST PRICE
AR160LFP-C/C	43.9	166.2	220	15	6.8	70	\$3,183.25
AR185LFP-C/C	48.1	182.1	220	15	7.4	70	\$3,268.85



C/C Version
 1 3/8" 6 Splined Thru Shaft.



Hydraulic Motor Flange Kit
 AR1570. For pump models
 AR160 - 370. Fits SAE 2-bolt A
 Flange Motors with 1" Shaft.

DIAPHRAGM KITS			VALVE KITS			O-RING KITS			OIL		
MODEL	DESCRIPTION	LIST PRICE	MODEL	DESCRIPTION	LIST PRICE	MODEL	DESCRIPTION	LIST PRICE	MODEL	DESCRIPTION	LIST PRICE
AR43259	BlueFlex™	\$209.76	AR43169	Valves	\$725.15	AR43170	O-Rings	\$200.98	AR64532D	Oil	\$16.59
AR43257	Desmopan	\$143.27							AR64532D-C	Case (6)Oil	\$96.30
AR43256	NBR	\$145.78									
AR43258	Viton	\$1,575.75									



AR330LFP • AR380LFP

S e r i e s
P O L Y P R O P Y L E N E
L I Q U I D F E R T I L I Z E R P E S T I C I D E

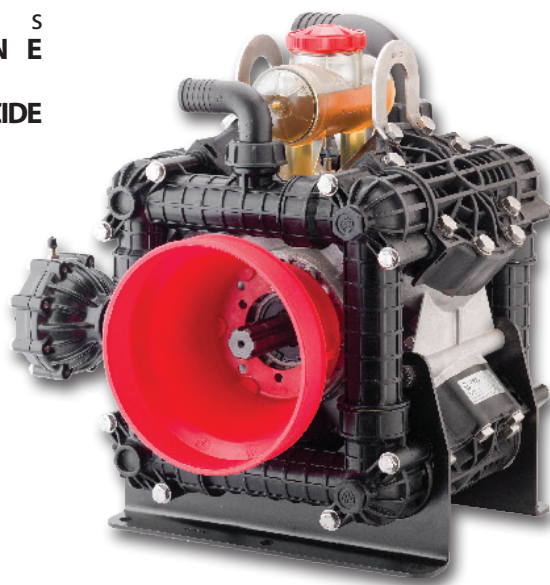

Low Pressure

140° F - Max Water Temp
 60 mm - Suction
 1-1/4" - Outlet

AR330LFP • AR380LFP - 550 RPM - SEMI-HYDRAULIC FOUR-DIAPHRAGM PUMP

MODEL	MAX GPM	MAX L/MIN	MAX PSI	MAX BAR	HP POWER	WEIGHT LBS.	LIST PRICE
AR330LFP-C/C	84.0	317.9	220	15	11.6	128	\$5,082.50
AR380LFP-C/C	97.1	367.7	220	15	13.8	128	\$5,200.20



C/C Version
 1 3/8" 6 Splined Thru Shaft.



Hydraulic Flange Kit AR55384.
 For models AR330, AR380,
 AR410 & AR460 Pumps.
 Fits SAE 2-Bolt A flange
 motors with 1" shaft.

DIAPHRAGM KITS			VALVE KITS			O-RING KITS			OIL		
MODEL	DESCRIPTION	LIST PRICE	MODEL	DESCRIPTION	LIST PRICE	MODEL	DESCRIPTION	LIST PRICE	MODEL	DESCRIPTION	LIST PRICE
AR43274	BlueFlex	\$415.33	AR43182	Valves	\$986.10	AR43183	O-Rings	\$246.90	AR64532D	Oil	\$16.59
AR43273	Desmopan	\$445.12							AR64532D-C	Case (6)Oil	\$96.30
AR43272	NBR	\$352.03									



AR410LFP • AR460LFP

S e r r i e s
P O L Y P R O P Y L E N E
L I Q U I D F E R T I L I Z E R P E S T I C I D E

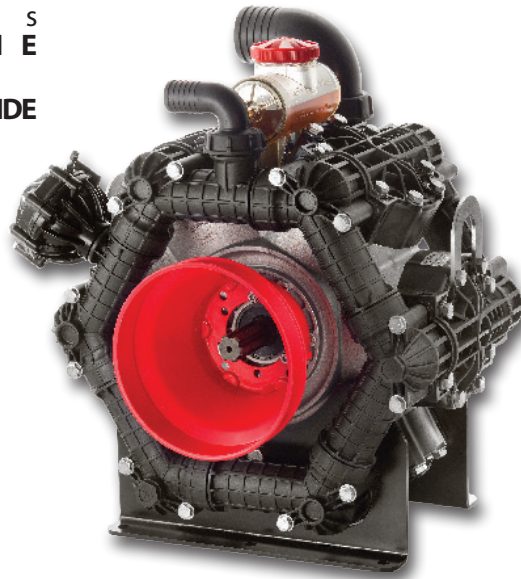

Low Pressure

140° F - Max Water Temp
 3" - Suction
 1-1/2" - Outlet

AR410LFP • AR460LFP - 550 RPM - SEMI-HYDRAULIC FOUR-DIAPHRAGM PUMP

MODEL	MAX GPM	MAX L/MIN	MAX PSI	MAX BAR	HP POWER	WEIGHT LBS.	LIST PRICE
AR410LFP-APC/C	106.0	401.2	220	15	14.9	166	\$7,580.95
AR460LFP-APC/C	119.0	450.3	220	15	17.4	166	\$7,768.20



C/C Version
 1 3/8" 6 Splined Thru Shaft.



Hydraulic Flange Kit AR55384.
 For models AR330, AR380,
 AR410 & AR460 Pumps.
 Fits SAE 2-Bolt A flange
 motors with 1" shaft.

DIAPHRAGM KITS			VALVE KITS			O-RING KITS			OIL		
MODEL	DESCRIPTION	LIST PRICE	MODEL	DESCRIPTION	LIST PRICE	MODEL	DESCRIPTION	LIST PRICE	MODEL	DESCRIPTION	LIST PRICE
AR43277	BlueFlex	\$545.28	AR43187	Valves	\$1,861.79	AR43188	O-Rings	\$83.05	AR64532D	Oil	\$16.59
AR43276	Desmopan	\$644.86							AR64532D-C	Case (6)Oil	\$96.30
AR43275	NBR	\$504.34									



AR45BP

S e r i e s
POLYPROPYLENE

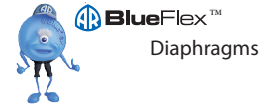

Low Pressure

140° F - Max Water Temp
1-1/4" - Suction
1" - Outlet

AR45BP - 550 RPM - SEMI-HYDRAULIC THREE-DIAPHRAGM PUMP

MODEL	MAX GPM	MAX L/MIN	MAX PSI	MAX BAR	HP POWER	WEIGHT LBS.	LIST PRICE
AR45BP-C	11.4	43.3	290	20	2.1	29	\$1,305.40
AR45BP-SP	11.4	43.3	290	20	2.1	28	\$1,267.95
AR45BP-GR3/4-GCI	11.4	43.3	290	20	2.1	38	\$2,198.85

GCI - Pump with a mounted control unit.



C Version
1 3/8" 6 Splined Shaft.



SP Version
Straight 3/4" Keyed Shaft.

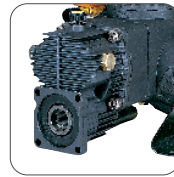

GR3/4-GCI Version
Gear Reduction AR31185 with
3/4" Hollow Shaft and GS25
Control Unit.



Hydraulic Flange AR55375. For
models AR45, AR60 & AR80
(SP Models Only). Fits SAE
2-bolt A Flange Motors
with 1" Shaft.

DIAPHRAGM KITS			VALVE KITS			O-RING KITS			OIL		
MODEL	DESCRIPTION	LIST PRICE	MODEL	DESCRIPTION	LIST PRICE	MODEL	DESCRIPTION	LIST PRICE	MODEL	DESCRIPTION	LIST PRICE
AR43239	BlueFlex	\$149.04	AR42524	Valves	\$280.78	AR42525	O-Rings	\$23.84	AR64532D	Oil	\$16.59
AR43237	Desmopan	\$130.72							AR64532D-C	Case (6)Oil	\$96.30
AR43236	NBR	\$102.88									
AR43238	Viton	\$443.18									



AR70BP

Plastic Coated
ALUMINUM



Low Pressure

140° F - Max Water Temp
1-1/4" - Suction
1" - Outlet

AR70BP - 550 RPM - SEMI-HYDRAULIC TWO-DIAPHRAGM PUMP

MODEL	MAX GPM	MAX L/MIN	MAX PSI	MAX BAR	HP POWER	WEIGHT LBS.	LIST PRICE
AR70BP-C	19.6	74.1	290	20	3.4	27	\$1,342.85
AR70BP-SP	19.6	74.1	290	20	3.4	28	\$1,284.00
AR70BP-GR3/4	19.6	74.1	290	20	3.4	36	\$2,134.65



C Version
1 3/8" 6 Splined Shaft.



SP Version
Use spline or straight shaft kits
on page 26.



GR3/4 Version
Gearbox AR1671 for
Gas Engine w/3/4" shaft.



Hydraulic Flange Kit
AR2495. For models AR70,
AR115, AR135 (SP Models
Only). Fits SAE 2-bolt A
Flange Motors
with 1" Shaft.



AR1511 Female
PTO Coupler.

DIAPHRAGM KITS			VALVE KITS			O-RING KITS			OIL		
MODEL	DESCRIPTION	LIST PRICE	MODEL	DESCRIPTION	LIST PRICE	MODEL	DESCRIPTION	LIST PRICE	MODEL	DESCRIPTION	LIST PRICE
AR43243	BlueFlex	\$99.36	AR2364	Valves	\$204.24	AR2365	O-Rings	\$23.25	AR64532D	Oil	\$16.59
AR43241	Desmopan	\$89.32							AR64532D-C	Case (6)Oil	\$96.30
AR43240	NBR	\$91.08									



AR80BP

S e r i e s
POLYPROPYLENE

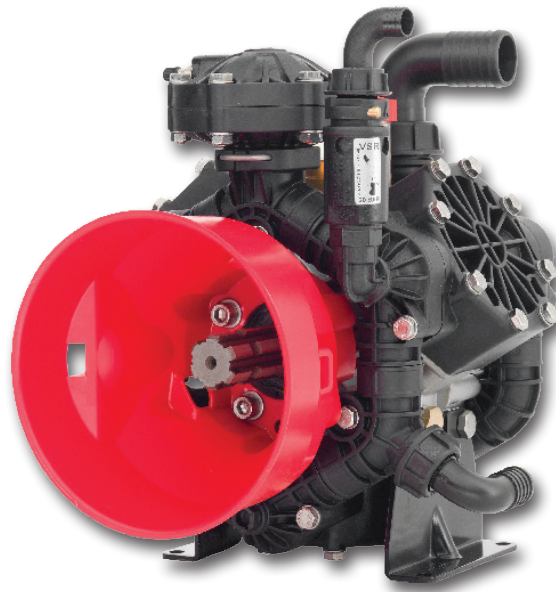

Low Pressure

140° F - Max Water Temp
1 1/2" - Suction
1" - Outlet

AR80BP - 550 RPM - SEMI-HYDRAULIC THREE-DIAPHRAGM PUMP

MODEL	MAX GPM	MAX L/MIN	MAX PSI	MAX BAR	HP POWER	WEIGHT LBS.	LIST PRICE
AR80BP-C	20.2	76.4	290	20	3.4	37	\$1,487.30
AR80BP-SP	20.2	76.4	290	20	3.4	37	\$1,471.25
AR80BP-GR3/4-GCI	20.2	76.4	290	20	3.4	46	\$2,514.50

GCI - Pump with a mounted control unit.



C Version
1 3/8" 6 Splined Shaft.



SP Version
Straight 3/4" Keyed Shaft.

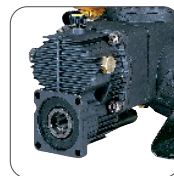

GR3/4-GCI Version
Assembled with GS355 Control
Unit and AR31185 Gearbox for
5-6 HP Gas Engines.



Hydraulic Flange AR55375.
For models AR45, AR60 & AR80
(SP Models Only). Fits SAE
2-bolt A Flange Motors
with 1" Shaft.

DIAPHRAGM KITS			VALVE KITS			O-RING KITS			OIL		
MODEL	DESCRIPTION	LIST PRICE	MODEL	DESCRIPTION	LIST PRICE	MODEL	DESCRIPTION	LIST PRICE	MODEL	DESCRIPTION	LIST PRICE
AR43247	BlueFlex	\$142.52	AR42805	Valves	\$270.89	AR42857	O-Rings	\$29.61	AR64532D	Oil	\$16.59
AR43245	Desmopan	\$145.03							AR64532D-C	Case (6)Oil	\$96.30
AR43244	NBR	\$136.24									
AR43246	Viton	\$437.99									



AR115BP • AR135BP AR115BP / 1000

Plastic Coated
ALUMINUM

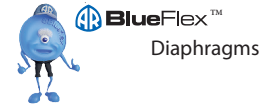
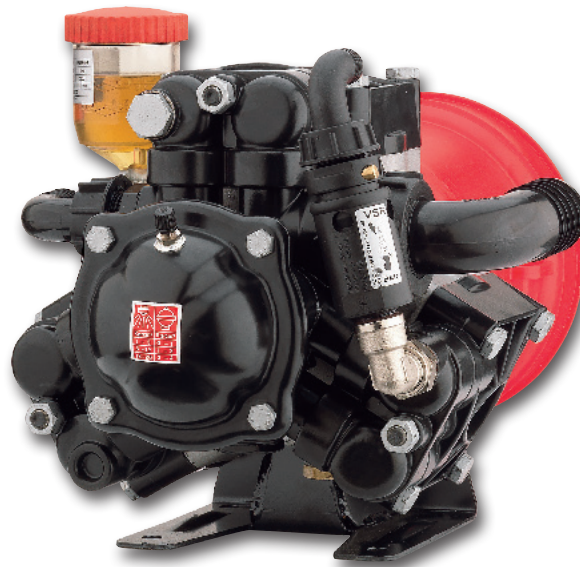

Low Pressure

140° F - Max Water Temp
1 1/2" - Suction
1" - Outlet

AR115BP • AR135BP - 550 RPM - SEMI-HYDRAULIC THREE-DIAPHRAGM PUMP

MODEL	MAX GPM	MAX L/MIN	MAX PSI	MAX BAR	HP POWER	WEIGHT LBS.	LIST PRICE
AR115BP-C	28.5	107.9	290	20	5.5	36	\$1,995.55
AR115BP-SP	28.5	107.9	290	20	5.5	37	\$1,926.00
AR115BP-GR3/4	28.5	107.9	290	20	5.5	45	\$2,605.45
AR135BP-C	33.8	128.0	290	20	6.8	36	\$2,027.65
AR135BP-SP	33.8	128.0	290	20	6.8	37	\$1,958.10
AR135BP-GR3/4	33.8	128.0	290	20	6.8	45	\$2,637.55
AR135BP-GR1	33.8	128.0	290	20	6.8	45	\$2,637.55

AR115BP - 1000 RPM - SEMI-HYDRAULIC THREE-DIAPHRAGM PUMP

MODEL	MAX GPM	MAX L/MIN	MAX PSI	MAX BAR	HP POWER	WEIGHT LBS.	LIST PRICE
AR115BP-C1000	24.8	94.0	220	15	4.2	36	\$2,054.40



C Version
1 3/8" 6 Splined Shaft.

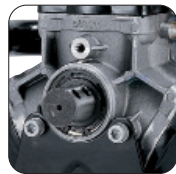

SP Version
Use spline or straight shaft kits.

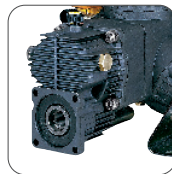

GR3/4 Version
Assembled with Gearbox
AR1671 for 5-6 HP
Gas Engines.



Hydraulic Flange Kit AR2495.
For models AR70, AR115,
AR135 (SP Models Only). Fits
SAE 2-bolt A Flange Motors
with 1" Shaft.



AR1511 Female
540 PTO Coupler
-SP models Only.

DIAPHRAGM KITS			VALVE KITS			O-RING KITS			OIL		
MODEL	DESCRIPTION	LIST PRICE	MODEL	DESCRIPTION	LIST PRICE	MODEL	DESCRIPTION	LIST PRICE	MODEL	DESCRIPTION	LIST PRICE
AR43251	BlueFlex	\$149.04	AR2370	Valves	\$302.54	AR2026	O-Rings	\$35.88	AR64532D	Oil	\$16.59
AR43249	Desmopan	\$116.43							AR64532D-C	Case (6)Oil	\$96.30
AR43248	NBR	\$118.18									



AR120BP • AR140BP

S e r i e s
N Y L O N

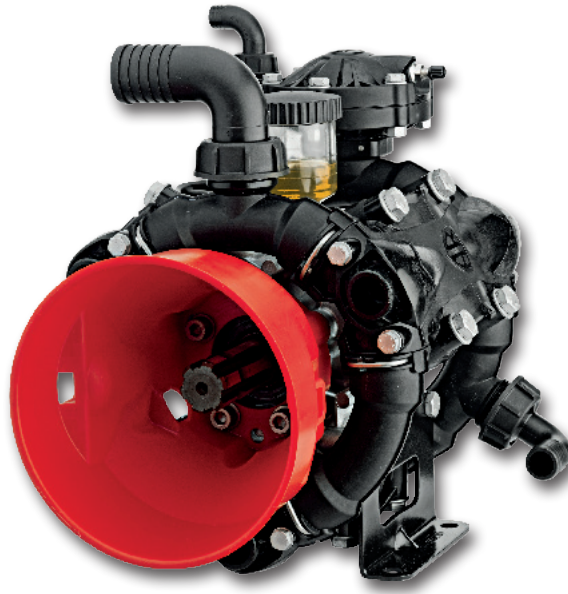

Low Pressure

140° F - Max Water Temp
1 1/2" - Suction
1" - Outlet

AR120BP • AR140BP - 550 RPM - SEMI-HYDRAULIC THREE-DIAPHRAGM PUMP

MODEL	MAX GPM	MAX L/MIN	MAX PSI	MAX BAR	HP POWER	WEIGHT LBS.	LIST PRICE
AR120BP-C	30.8	116.7	220	15	4.5	41	\$1,979.50
AR120BP-SP	30.8	116.7	220	15	4.5	39	\$1,931.35
AR140BP-C	35.1	132.9	220	15	5.2	41	\$2,033.00
AR140BP-SP	35.1	132.9	220	15	5.2	39	\$1,984.85



C Version
1 3/8" 6 Splined Shaft.



SP Version
Straight 25mm Keyed Shaft.



Hydraulic Flange Kit AR55376.
For models AR120, AR140 (SP Models Only). Fits SAE 2-bolt A Flange Motors with 1" Shaft.

DIAPHRAGM KITS			VALVE KITS			O-RING KITS			OIL		
MODEL	DESCRIPTION	LIST PRICE	MODEL	DESCRIPTION	LIST PRICE	MODEL	DESCRIPTION	LIST PRICE	MODEL	DESCRIPTION	LIST PRICE
AR43255	BlueFlex	\$149.04	AR42805	Valves	\$270.89	AR42830	O-Rings	\$54.45	AR64532D	Oil	\$16.59
AR43253	Desmopan	\$148.05							AR64532D-C	Case (6)Oil	\$96.30
AR43252	NBR	\$150.05									
AR43254	Viton	\$1,144.17									



AR160BP • AR185BP

Plastic Coated
ALUMINUM

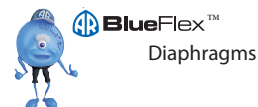
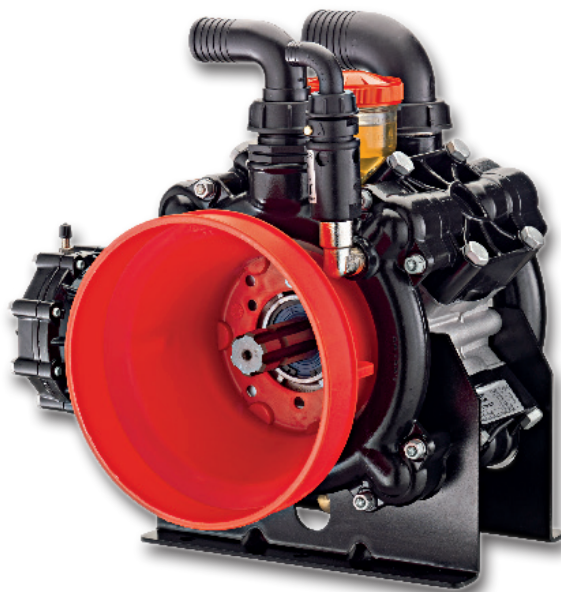

Low Pressure

140° F - Max Water Temp
2" - Suction
1-1/2" - Outlet

AR160BP • AR185BP - 550 RPM - SEMI-HYDRAULIC FOUR-DIAPHRAGM PUMP

MODEL	MAX GPM	MAX L/MIN	MAX PSI	MAX BAR	HP POWER	WEIGHT LBS.	LIST PRICE
AR160BP-C/C	43.9	166.2	290	20	8.4	67	\$3,183.25
AR185BP-C/C	48.1	182.1	290	20	9.3	67	\$3,268.85



C/C Version
1 3/8" 6 Splined Thru Shaft.



Hydraulic Motor Flange Kit
AR1570. For pump models
AR160 - 370. Fits SAE 2-bolt A
Flange Motors with 1" Shaft.

DIAPHRAGM KITS			VALVE KITS			O-RING KITS			OIL		
MODEL	DESCRIPTION	LIST PRICE	MODEL	DESCRIPTION	LIST PRICE	MODEL	DESCRIPTION	LIST PRICE	MODEL	DESCRIPTION	LIST PRICE
AR43259	BlueFlex	\$209.76	AR2374	Valves	\$400.46	AR42510	O-Rings	\$61.23	AR64532D	Oil	\$16.59
AR43257	Desmopan	\$143.27							AR64532D-C	Case (6)Oil	\$96.30
AR43256	NBR	\$145.78									
AR43258	Viton	\$1,575.75									



AR215BP • AR250BP • AR280BP

Plastic Coated
ALUMINUM

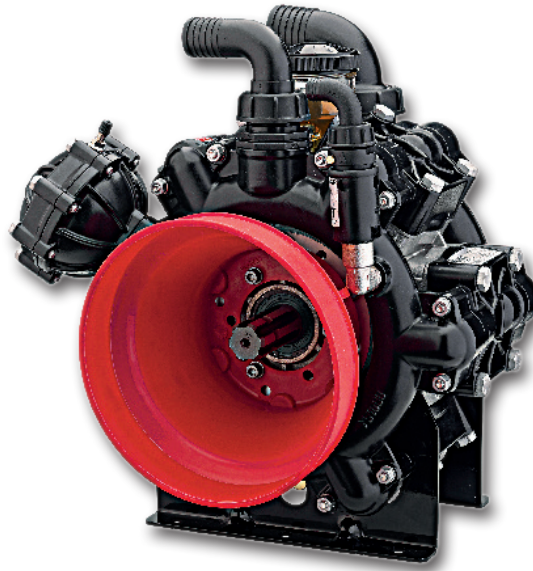

Low Pressure

140° F - Max Water Temp
2" - Suction (AR215 - AR250)
2 1/2" - Suction (AR280)
1-1/4" - Outlet

AR215BP • AR250BP • AR280BP - 550 RPM - SEMI-HYDRAULIC SIX-DIAPHRAGM PUMP

MODEL	MAX GPM	MAX L/MIN	MAX PSI	MAX BAR	HP POWER	WEIGHT LBS.	LIST PRICE
AR215BP-C/C	57.9	219.1	290	20	9.9	91	\$4,060.65
AR250BP-C/C	67.2	254.4	290	20	11.4	91	\$4,178.35
AR280BP-C/C	73.4	277.8	290	20	12.9	91	\$4,488.65



C/C Version
1 3/8" 6 Splined Thru Shaft.



Hydraulic Motor Flange Kit
AR1570. For pump models
AR160 - 370. Fits SAE 2-bolt A
Flange Motors with 1" Shaft.

DIAPHRAGM KITS			VALVE KITS			O-RING KITS			OIL		
MODEL	DESCRIPTION	LIST PRICE	MODEL	DESCRIPTION	LIST PRICE	MODEL	DESCRIPTION	LIST PRICE	MODEL	DESCRIPTION	LIST PRICE
AR43263	BlueFlex	\$314.64	AR2114	Valves	\$597.18	AR42513	O-Rings	\$75.27	AR64532D	Oil	\$16.59
AR43261	Desmopan	\$196.46							AR64532D-C	Case (6)Oil	\$96.30
AR43260	NBR	\$200.23									



AR330BP • AR380BP

Plastic Coated
ALUMINUM



Low Pressure

140° F - Max Water Temp
2 1/2" - Suction
1-1/4" - Outlet

AR330BP • AR380BP - 550 RPM - SEMI-HYDRAULIC FOUR-DIAPHRAGM PUMP

MODEL	MAX GPM	MAX L/MIN	MAX PSI	MAX BAR	HP POWER	WEIGHT LBS.	LIST PRICE
AR330BP-C/C	84.2	317.9	290	20	17.4	132	\$5,082.50
AR380BP-C/C	97.1	367.7	290	20	17.4	132	\$5,200.20



C/C Version
1 3/8" 6 Splined Thru Shaft.



Hydraulic Flange Kit AR55384.
For models AR330, AR380,
AR410 & AR460 Pumps.
Fits SAE 2-Bolt A flange motors
with 1" shaft.

DIAPHRAGM KITS			VALVE KITS			O-RING KITS			OIL		
MODEL	DESCRIPTION	LIST PRICE	MODEL	DESCRIPTION	LIST PRICE	MODEL	DESCRIPTION	LIST PRICE	MODEL	DESCRIPTION	LIST PRICE
AR43274	BlueFlex	\$415.33	AR42980	Valves	\$732.67	AR42591	O-Rings	\$75.27	AR64532D	Oil	\$16.59
AR43273	Desmopan	\$445.12							AR64532D-C	Case (6)Oil	\$96.30
AR43272	NBR	\$352.03									



AR410BP • AR460BP

S e r i e s
N Y L O N



BlueFlex™
Diaphragms

Low Pressure

140° F - Max Water Temp
3" - Suction
1-1/2" - Outlet

AR410BP • AR460BP - 550 RPM - SEMI-HYDRAULIC SIX-DIAPHRAGM PUMP

MODEL	MAX GPM	MAX L/MIN	MAX PSI	MAX BAR	HP POWER	WEIGHT LBS.	LIST PRICE
AR410BP-C/C	106	401.2	290	20	22.4	173.1	\$7,580.95
AR460BP-C/C	119	450.3	290	20	22.4	173.1	\$7,768.20

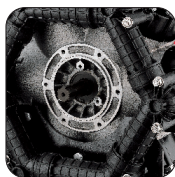

C/C Version
1 3/8" 6 Splined Thru Shaft.



Hydraulic Flange Kit AR55384.
For models AR330, AR380,
AR410 & AR460 Pumps.
Fits SAE 2-Bolt A flange motors
with 1" shaft.

DIAPHRAGM KITS			VALVE KITS			O-RING KITS			OIL		
MODEL	DESCRIPTION	LIST PRICE	MODEL	DESCRIPTION	LIST PRICE	MODEL	DESCRIPTION	LIST PRICE	MODEL	DESCRIPTION	LIST PRICE
AR43277	BlueFlex	\$545.28	AR42290	Valves	\$795.41	AR42291	O-Rings	\$260.95	AR64532D	Oil	\$16.59
AR43276	Desmopan	\$644.86							AR64532D-C	Case (6)Oil	\$96.30
AR43275	NBR	\$504.34									



AR320BP • AR370BP Twin Top

Plastic Coated
ALUMINUM



BlueFlex™
Diaphragms

Low Pressure

140° F - Max Water Temp
2 x 2" - Suction
2 x 1-1/4" - Outlet

AR320BP • AR370BP - 550 RPM - SEMI-HYDRAULIC EIGHT (FOUR PLUS FOUR) DIAPHRAGM PUMP

MODEL	MAX GPM	MAX L/MIN	MAX PSI	MAX BAR	HP POWER	WEIGHT LBS.	LIST PRICE
AR320BPTWINTOP-C/C	84.9	321.2	290	20	16.8	127.9	\$6,286.25
AR370BPTWINTOP-C/C	98.2	371.5	290	20	17.3	127.9	\$6,398.60



C/C Version
1 3/8" 6 Splined Thru Shaft.

DIAPHRAGM KITS (2)			VALVE KITS (2)			O-RING KITS (2)			OIL		
MODEL	DESCRIPTION	LIST PRICE	MODEL	DESCRIPTION	LIST PRICE	MODEL	DESCRIPTION	LIST PRICE	MODEL	DESCRIPTION	LIST PRICE
AR43267	BlueFlex	\$381.39	AR2374	Valves	\$400.46	AR42510	O-Rings	\$61.23	AR64532D	Oil	\$16.59
AR43265	Desmopan	\$377.49							AR64532D-C	Case (6)Oil	\$96.30
AR43264	NBR	\$275.50									
AR43266	Viton	\$3,131.42									



AR500BP • AR560BP Twin Top

Plastic Coated
ALUMINUM



Low Pressure

140° F - Max Water Temp
2 x 2" - Suction (AR500)
2 x 2 1/2" - Suction (AR560)
2 x 1-1/4" - Outlet

AR500BP • AR560BP - 550 RPM - SEMI-HYDRAULIC TWELVE (SIX PLUS SIX) DIAPHRAGM PUMP

MODEL	MAX GPM	MAX L/MIN	MAX PSI	MAX BAR	HP POWER	WEIGHT LBS.	LIST PRICE
AR500BPTWINTOP-C/C	129.3	489.4	290	20	23.6	165.3	\$8,206.90
AR560BPTWINTOP-C/C	143.5	543.2	290	20	26.6	165.3	\$8,313.90



C/C Version
1 3/8" 6 Splined Thru Shaft.

DIAPHRAGM KITS (2)			VALVE KITS (2)			O-RING KITS (2)			OIL		
MODEL	DESCRIPTION	LIST PRICE	MODEL	DESCRIPTION	LIST PRICE	MODEL	DESCRIPTION	LIST PRICE	MODEL	DESCRIPTION	LIST PRICE
AR43271	BlueFlex	\$572.09	AR2114	Valves	\$597.18	AR42513	O-Rings	\$75.27	AR64532D	Oil	\$16.59
AR43269	Desmopan	\$376.88							AR64532D-C	Case (6)Oil	\$96.30
AR43268	NBR	\$384.65									
AR43270	Viton	\$4,511.45									



AR300MLC-C/C

NEW

A n o d i z e d
A L U M I N U M



BlueFlex™
Diaphragms

Low Pressure

AR500BP • AR560BP - 550 RPM - SEMI-HYDRAULIC TWELVE (SIX PLUS SIX) DIAPHRAGM PUMP

MODEL	MAX GPM	MAX L/MIN	MAX PSI	MAX BAR	HP POWER	WEIGHT LBS.	LIST PRICE
AR300MLC-C/C	79	300	218	15	20.5	97	\$5,596.10

DIAPHRAGM KITS			VALVE KITS			O-RING KITS			OIL		
MODEL	DESCRIPTION	LIST PRICE	MODEL	DESCRIPTION	LIST PRICE	MODEL	DESCRIPTION	LIST PRICE	MODEL	DESCRIPTION	LIST PRICE
AR46464	BlueFlex	\$149.04	AR46465	Valves	\$217.96	AR46466	Oil Seals	\$82.56	AR64532D	Oil	\$16.59
									AR64532D-C	Case (6)Oil	\$96.30



Application Kits

Low Pressure

Shaft Kit AR43392: 1 3/8" Male Spline Shaft \$160.32



1" ³/₈" universal shaft

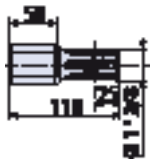

For Models: AR70, AR115 & AR135

Pulley Kit AR1514 \$301.10



Pulley 2A 11" Diameter



For Models: AR70, AR115 & AR135

Gearbox Kit 3/4": for 5-6 HP Gas Engine



Gearbox for four stroke engines with SAE J609a flange

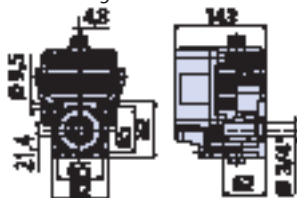

AR1671 For Models: AR70, AR115 & AR135 \$643.00

AR31185 For Models: AR45, AR60 & AR80 \$663.00

Hydraulic Motor Flange Kit AR55384 \$661.05

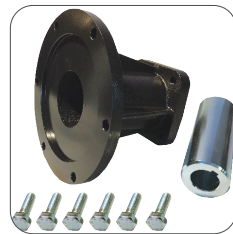

For models AR330, AR380, AR410 & AR460 Pumps
Fits SAE 2-Bolt A flange motors with 1" shaft

Shaft Kit AR43389: 1" Male Solid Keyed Shaft \$266.15



For models AR70, AR115 & AR135
Kit includes a male PTO shaft adapter, mounting bracket and necessary hardware.

Female 540 PTO Shaft Kit AR1511 \$280.79



For models AR70, AR115 & AR135 (SP models Only)

Hydraulic Motor Flange Kit AR55371 \$656.50



For models AR410 - 460
Fits 4 Bolt B Flange Motors with 32mm Shaft

Hydraulic Motor Flange Kit AR1570 \$426.59



For models AR160 - 370
Fits SAE 2-bolt A Flange Motors with 1" Shaft

Hydraulic Motor Flange Kit AR2495 \$421.53



For models AR70, AR115, AR135 (SP Models Only)
Fits SAE 2-bolt A Flange Motors with 1" Shaft

Hydraulic Motor Flange Kit AR55375 \$340.90



For models AR45, AR60 & AR80 (SP Models Only)
Fits SAE 2-bolt A Flange Motors with 1" Shaft

Hydraulic Motor Flange Kit AR55376 \$340.90



For models AR120, AR140 (SP Models Only)
Fits SAE 2-bolt A Flange Motors with 1" Shaft

The part numbers refer to the application kit only, excluding the pump. The applications should be used only with the proper protective equipment for the safety of the operator.



Control Units

Low Pressure

ECM-3

Remote control unit with working pressure regulating valve, complete with glycerin filled pressure gauge with colored dial.

- AR70BP - AR160BP
- 140° F Max Temperature
- 1" - Inlet
- 1" - Return
- 1/2" - Outlet (3)

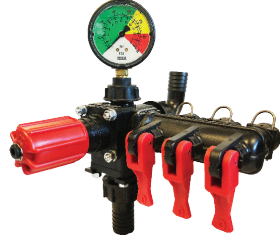

MODEL	MAX GPM	MAX L/MIN	MAX PSI	MAX BAR	WEIGHT LBS	LIST PRICE
ECM-3	42.3	160	290	20	3.5	\$481.50

UCM-3

Remote control unit with working pressure regulating valve, opening/closing control lever, anti-drip and glycerin filled pressure gauge with colored dial.

- AR70BP - AR160BP
- 140° F Max Temperature
- 1" - Inlet
- 1" - Return
- 1/2" - Outlet (3)



MODEL	MAX GPM	MAX L/MIN	MAX PSI	MAX BAR	WEIGHT LBS	LIST PRICE
UCM-3	42.3	160	290	20	6	\$818.55

IDROMINUS

Remote control unit with working pressure regulating valve, opening/closing control lever, anti drip, valves with pressure discharge regulation and glycerin filled pressure gauge with colored dial.

- AR70BP - AR160BP
- 140° F Max Temperature
- 1" - Inlet
- 1" - Return
- 1/2" - Outlet



MODEL	MAX GPM	MAX L/MIN	MAX PSI	MAX BAR	WEIGHT LBS	LIST PRICE
IDROMINUS	42.3	160	290	20	6.6-7.1	\$1,219.80

GS 25 S / GS 25 V (VITON)

Remote control unit with working pressure regulating valve, by-pass control and glycerin filled pressure gauge with colored dial.

- AR45BP - AR45LFP
- 140° F Max Temperature
- 1" - Inlet
- 3/4" - Return
- 3/8" - Outlet
- AR43821 - replacement control for direct mount.



MODEL	MAX GPM	MAX L/MIN	MAX PSI	MAX BAR	WEIGHT LBS	LIST PRICE
GS25S	13.2	50	290	20	2.2	\$251.45
AR43821	13.2	50	290	20	2.2	\$85.31
GS25V	13.2	50	290	20	2.2	\$284.95

GS 35 S / GS 35 V (VITON)

Remote control unit with working pressure regulating valve, by-pass control and glycerin filled pressure gauge with colored dial.

- AR45BP, AR80BP
- 140° F Max Temperature
- 1" - Inlet
- 1" - Return
- 3/8" - Outlet

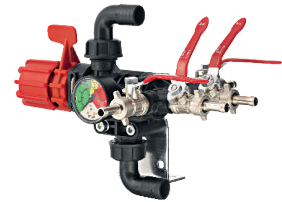

MODEL	MAX GPM	MAX L/MIN	MAX PSI	MAX BAR	WEIGHT LBS	LIST PRICE
GS35S	26.4	100	290	20	3.7	\$353.10
GS35V	26.5	100	290	20	3.7	\$474.57
MODEL	DESCRIPTION					LIST PRICE
AR3249006	Direct mount kit					\$257.11

GS 20 S

Remote control unit with working pressure regulating valve and glycerin filled pressure gauge with colored dial.

- AR70BP
- 140° F Max Temperature
- 3/4" - Inlet
- 3/4" - Return
- 3/8" - Outlet

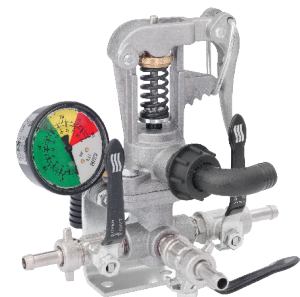

MODEL	MAX GPM	MAX L/MIN	MAX PSI	MAX BAR	WEIGHT LBS	LIST PRICE
GS20S	13.2	50	290	20	3.5	\$369.15



Control Units

Low Pressure

RM 20 S

Remote control unit with working pressure regulating valve, by-pass control and glycerin filled pressure gauge with colored dial.

- AR70BP - AR115BP
- 140° F Max Temperature
- 1" - Inlet
- 1" - Return
- 3/8" - Outlet



MODEL	MAX GPM	MAX L/MIN	MAX PSI	MAX BAR	WEIGHT LBS	LIST PRICE
RM20S	21.1	80	290	20	3.5	\$449.40

VDR 20 S

Remote control unit with working pressure regulating valve, opening/closing control lever and glycerin filled pressure gauge with colored dial.

- AR70BP - AR135BP
- 140° F Max Temperature
- 1" - Inlet
- 1" - Return
- 3/8" - Outlet

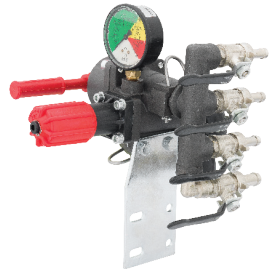

MODEL	MAX GPM	MAX L/MIN	MAX PSI	MAX BAR	WEIGHT LBS	LIST PRICE
VDR20S	34.3	130	290	20	4.9	\$716.90

VSP

Automatic spring-loaded maximum pressure safety valves. These valves are made of a plastic (nylon and fiberglass) which is particularly resistant to liquid chemical products and abrasive liquid chemical products. If they are used as safety valves, they guarantee a constant pressure whenever it is not necessary to continuously regulate the working pressure. Any excess liquid bypasses the valve and allows it to maintain a constant line pressure.



- VSP200
 - AR70BP - 185BP
- VSP400
 - AR215BP - AR380BP
 - AR320BPTwinTop - AR370BPTwinTop
- VSP600
 - AR410BP - AR460BP
 - AR500BPTwinTop - AR560BPTwinTop

- 140° F Max Temperature
- VSP200 - 1" GAS
- VSP400 - 1-1/2" GAS
- VSP600 - 2" GAS

MODEL	MAX GPM	MAX L/MIN	MAX PSI	MAX BAR	WEIGHT LBS	LIST PRICE
VSP200	53	200	290	20	1.1	\$288.90
VSP400	105	400	290	20	2.4	\$524.30
VSP600	158	600	218	15	6.8	\$952.30



AR-DUE

A n o d i z e d
A L U M I N U M

Medium Pressure

140° F - Max Water Temp
3/4" - Suction
1/2" NPT - Outlet

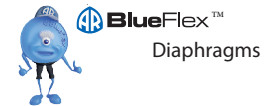
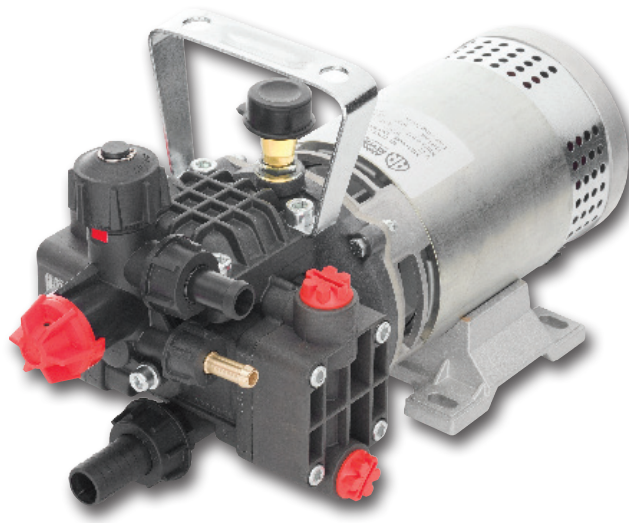

AR-DUE - 1450 RPM - SEMI-HYDRAULIC TWO DIAPHRAGM PUMP AND MOTOR

MODEL	MAX GPM	MAX L/MIN	MAX PSI	MAX BAR	HP POWER	WEIGHT LBS.	LIST PRICE
AR-DUE-V.R.I.-12 (12 Volt Motor)	3.5	13	145	10	0.34	23	\$1,543.43
AR-DUE-V.R.I.-24 (24 Volt Motor)	3.5	13	145	10	0.34	23	\$1,434.40

DIAPHRAGM KITS			VALVE KITS			O-RING KITS			OIL		
MODEL	DESCRIPTION	LIST PRICE	MODEL	DESCRIPTION	LIST PRICE	MODEL	DESCRIPTION	LIST PRICE	MODEL	DESCRIPTION	LIST PRICE
AR43789	BlueFlex	\$79.04	AR1992	Valves	\$78.28	AR2465	O-Rings	\$15.05	AR64532D	Oil	\$16.59
									AR64532D-C	Case (6)Oil	\$96.30



AR252

Anodized
ALUMINUM

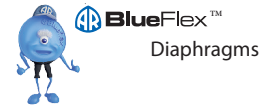
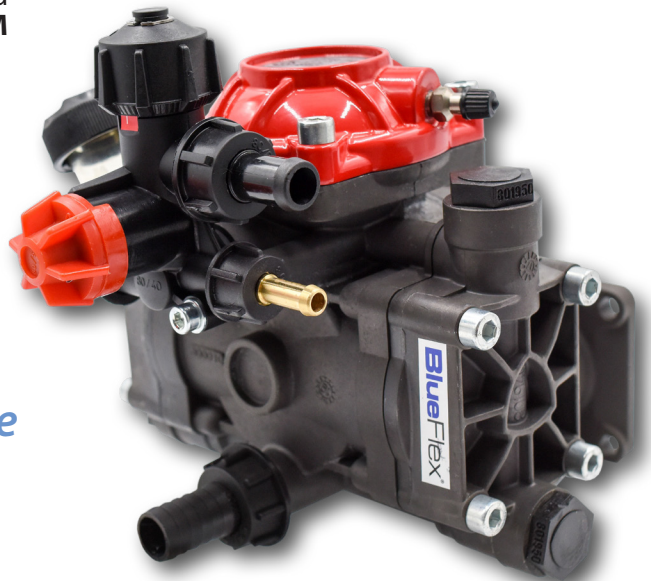

Medium Pressure

140° F - Max Water Temp
3/4" - Suction
1/2" BSP - Outlet

AR252 - 650 RPM - SEMI-HYDRAULIC TWO DIAPHRAGM PUMP

MODEL	MAX GPM	MAX L/MIN	MAX PSI	MAX BAR	HP POWER	WEIGHT LBS.	LIST PRICE
AR252-SP/SGC	6.5	24.6	362	25	1.42	8.8	\$861.35
AR252-SP/A5/8	6.5	24.6	362	25	1.42	8.8	\$946.95
AR252-GR-GCI5/8	6.5	24.6	362	25	1.42	8.8	\$1,278.65
AR252-GR-GCI3/4	6.5	24.6	362	25	1.42	14	\$1,278.65
AR252D-GR-GCI3/4	6.5	24.6	362	25	1.42	14	\$1,278.65
AR252-GR/A5/8-GCI	6.5	24.6	362	25	1.42	14	\$1,364.25

GCI - Pump with a mounted control unit.

AR252D - Version has Desmopan diaphragms.



SP/SGC Version
Straight 3/4" Keyed Shaft
1/2" BSP threaded outlet flange.

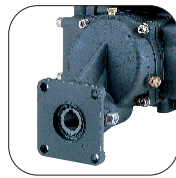

GR-GCI5/8 Version
With AR1912 Control Unit and
AR1615 Gearbox with 5/8"
Hollow Shaft.

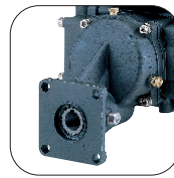

GR-GCI3/4 Version
With AR1912 Control Unit and
AR1613 Gearbox with 3/4"
Hollow Shaft.



SP/A5/8 Version
Straight 3/4" Keyed Shaft with
5/8" Keyed Solid Thru Shaft.

DIAPHRAGM KITS			VALVE KITS			O-RING KITS			OIL		
MODEL	DESCRIPTION	LIST PRICE	MODEL	DESCRIPTION	LIST PRICE	MODEL	DESCRIPTION	LIST PRICE	MODEL	DESCRIPTION	LIST PRICE
AR43281	BlueFlex	\$66.24	AR2408	Valves	\$81.04	AR2409	O-Rings	\$18.56	AR64532D	Oil	\$16.59
AR43278	NBR	\$69.25							AR64532D-C	Case (6)Oil	\$96.30
AR43279	Desmopan	\$55.20									



AR30

Plastic Coated
ALUMINUM

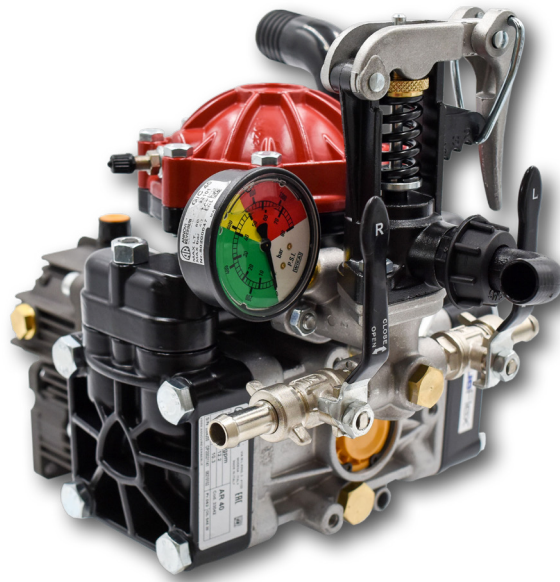

Medium Pressure

140° F - Max Water Temp
1" - Hose Barb Inlet
1/2" - Hose Barb Outlet

AR30 - 550 RPM - SEMI-HYDRAULIC TWO DIAPHRAGM PUMP

MODEL	MAX GPM	MAX L/MIN	MAX PSI	MAX BAR	HP POWER	WEIGHT LBS.	LIST PRICE
AR30-SP	9.6	36.2	580	40	2.9	22	\$957.65
AR30D-SP	9.6	36.2	580	40	2.9	22	\$957.65
AR30-SP/A3/4	9.6	36.2	580	40	2.9	22	\$1067.86
AR30-GR3/4-GCI	9.6	36.2	580	40	2.9	32	\$1,797.60
AR30D-GR3/4-GCI	9.6	36.2	580	40	2.9	32	\$1,797.60

GCI - Pump with a mounted control unit.

AR30D - Versions have Desmopan diaphragms.

NEW

AR30 EM230-1 - 550 RPM - SEMI-HYDRAULIC TWO DIAPHRAGM PUMP

MODEL	MAX GPM	MAX L/MIN	MAX PSI	MAX BAR	HP POWER	WEIGHT LBS.	LIST PRICE
AR30-EM230-1	9.6	36.2	400	27	3.5	87	\$3,057.15

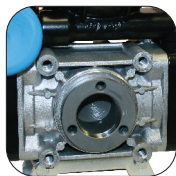

SP Version
Flanged shaft for shaft kits,
Gear Boxes, Pulleys &
Hydraulic Flange kits.



GR3/4-GCI Version
Gear Reduction AR1636 with
3/4" Hollow Shaft and GIC40
Control Unit.



SP/A3/4 Version
SP Version with 3/4" Solid
Keyed Thru Shaft.

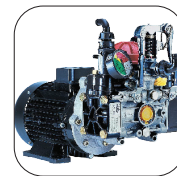

EM230-1
Electric Motor.



Hydraulic Flange Kit
AR43397. AR30, AR40 (SP
Models Only). Fits SAE 2-bolt
A Flange Motors with
1" Shaft.

DIAPHRAGM KITS			VALVE KITS			O-RING KITS			OIL		
MODEL	DESCRIPTION	LIST PRICE	MODEL	DESCRIPTION	LIST PRICE	MODEL	DESCRIPTION	LIST PRICE	MODEL	DESCRIPTION	LIST PRICE
AR43285	BlueFlex	\$81.80	AR1917	Valves	\$157.46	AR1916	O-Rings	\$14.42	AR64532D	Oil	\$16.59
AR43283	Desmopan	\$74.53							AR64532D-C	Case (6)Oil	\$96.30
AR43282	Buna	\$76.53									



AR40

Plastic Coated
ALUMINUM

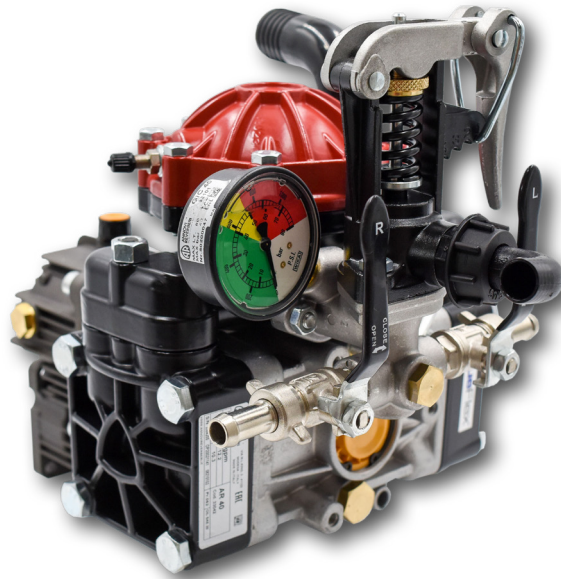

Medium Pressure

140° F - Max Water Temp
1-1/4" - Suction
1/2" NPT - Outlet

AR40 - 550 RPM - SEMI-HYDRAULIC TWO DIAPHRAGM PUMP

MODEL	MAX GPM	MAX L/MIN	MAX PSI	MAX BAR	HP POWER	WEIGHT LBS.	LIST PRICE
AR40-SP	12.2	46.3	580	40	3.5	22	\$1,118.15
AR40-SP/A3/4	12.2	46.3	580	40	3.5	22	\$1,228.36
AR40-GR3/4-GCI	12.2	46.3	580	40	3.5	32	\$1,958.10

GCI - Pump with a mounted control unit.

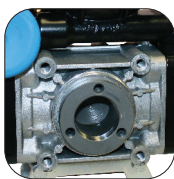

SP Version
Flanged shaft for shaft kits on page 35.



GR3/4-GCI Version
Gear Reduction AR1636 with 3/4" Hollow Shaft and GIC40 Control Unit.



SP/A3/4 Version
SP Version with 3/4" Solid Keyed Thru Shaft.



Hydraulic Flange Kit AR43397.
AR30, AR40 (SP Models Only).
Fits SAE 2-bolt A Flange Motors with 1" Shaft.

DIAPHRAGM KITS			VALVE KITS			O-RING KITS			OIL		
MODEL	DESCRIPTION	LIST PRICE	MODEL	DESCRIPTION	LIST PRICE	MODEL	DESCRIPTION	LIST PRICE	MODEL	DESCRIPTION	LIST PRICE
AR43285	BlueFlex	\$81.80	AR1917	Valves	\$157.46	AR1916	O-Rings	\$14.42	AR64532D	Oil	\$16.59
AR43283	Desmopan	\$74.53							AR64532D-C	Case (6)Oil	\$96.30
AR43282	Buna	\$76.53									



AR50

Plastic Coated
ALUMINUM

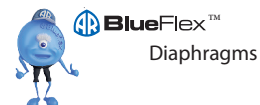

Medium Pressure

140° F - Max Water Temp
1-1/4" - Suction
1/2" NPT - Outlet

AR50 - 550 RPM - SEMI-HYDRAULIC TWO DIAPHRAGM PUMP

MODEL	MAX GPM	MAX L/MIN	MAX PSI	MAX BAR	HP POWER	WEIGHT LBS.	LIST PRICE
AR50-SP	14.8	65.8	580	40	5.2	39.3	\$1,674.55
AR50D-SP	14.8	65.8	580	40	5.2	39.3	\$1,674.55
AR50-SP/A1	14.8	65.8	580	40	5.2	37	\$1,824.35
AR50-GR1-GCI	14.8	65.8	580	40	5.2	48	\$2,272.68
AR50D-GR1-GCI	14.8	65.8	580	40	5.2	48	\$2,272.68
AR50-GR3/4-GCI	14.8	65.8	580	40	5.2	48	\$2,272.68

GCI - Pump with a mounted control unit.

AR50D - Versions have Desmopan diaphragms.

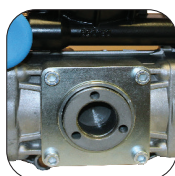

SP Version
Flanged shaft for shaft kits on page 35.



GR1-GCI Version
Gearbox AR1639 with 1" Hollow Shaft and GIC40 Control Unit.



SP/A1 Version
SP Version with Solid 1" Keyed Thru Shaft.



Hydraulic Flange Kit AR43397.
AR50 (SP Models Only).
Fits SAE 2-bolt A Flange Motors with 1" Shaft.

DIAPHRAGM KITS			VALVE KITS			O-RING KITS			OIL		
MODEL	DESCRIPTION	LIST PRICE	MODEL	DESCRIPTION	LIST PRICE	MODEL	DESCRIPTION	LIST PRICE	MODEL	DESCRIPTION	LIST PRICE
AR43293	BlueFlex	\$85.31	AR1920	Valves	\$161.33	AR1919	O-Rings	\$26.85	AR64532D	Oil	\$16.59
AR43291	Desmopan	\$81.04							AR64532D-C	Case (6)Oil	\$96.30
AR43290	Buna	\$78.78									



AR303 • AR403

Anodized
ALUMINUM

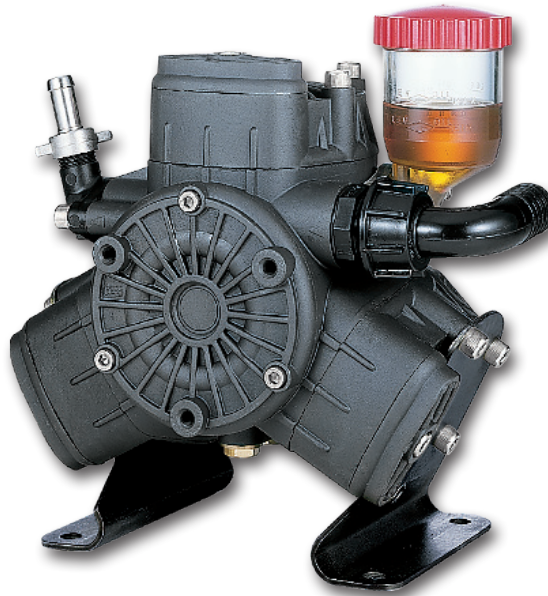

Medium Pressure

140° F - Max Water Temp
1" - Suction
1/2" NPT - Outlet

AR303 • AR403 - 550 RPM - SEMI-HYDRAULIC THREE DIAPHRAGM PUMP

MODEL	MAX GPM	MAX L/MIN	MAX PSI	MAX BAR	HP POWER	WEIGHT LBS.	LIST PRICE
AR303-SP	9.2	34.7	580	40	3.1	23	\$1,230.50
AR303-GR3/4-GCI	9.2	34.7	580	40	3.1	34	\$1,797.60
AR403-SP	10.7	40.7	580	40	3.7	23	\$1,257.25
AR403-GR3/4-GCI	10.7	40.7	580	40	3.7	34	\$1,792.25

GCI - Pump with a mounted control unit.



SP Version
Flanged shaft for shaft kits
on page 35.



GR3/4-GCI Version
Gear Reduction AR1636 with
3/4" Hollow Shaft and GR40
Control Unit.



Hydraulic Flange Kit AR43397.
AR303, AR403 (SP Models
Only). Fits SAE 2-bolt A Flange
Motors with 1" Shaft.

DIAPHRAGM KITS			VALVE KITS			O-RING KITS			OIL		
MODEL	DESCRIPTION	LIST PRICE	MODEL	DESCRIPTION	LIST PRICE	MODEL	DESCRIPTION	LIST PRICE	MODEL	DESCRIPTION	LIST PRICE
AR43289	BlueFlex	\$73.52	AR2388	Valves	\$170.62	AR2389	O-Rings	\$21.11	AR64532D	Oil	\$16.59
AR43287	Desmopan	\$73.02							AR64532D-C	Case (6)Oil	\$96.30
AR43286	NBR	\$68.50									



AR503

Anodized
ALUMINUM

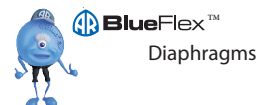
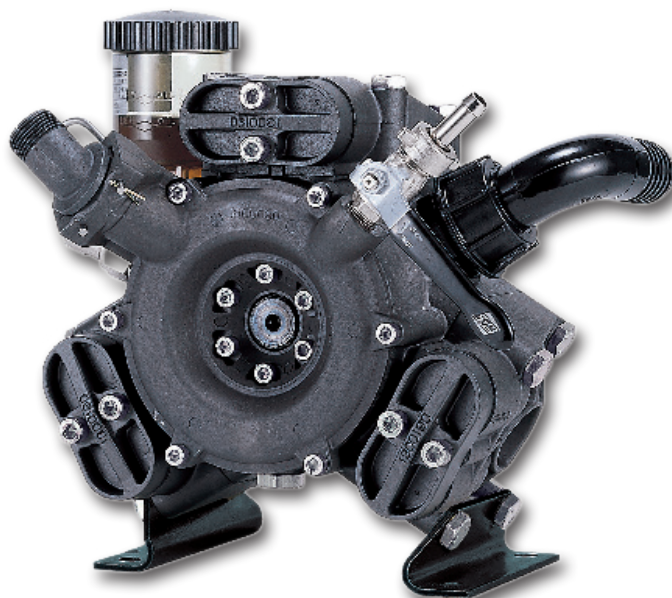

Medium Pressure

140° F - Max Water Temp
1-1/4" - Suction
3/4" NPT - Outlet

AR503 - 550 RPM - SEMI-HYDRAULIC THREE DIAPHRAGM PUMP

MODEL	MAX GPM	MAX L/MIN	MAX PSI	MAX BAR	HP POWER	WEIGHT LBS.	LIST PRICE
AR503-SP	14.3	54.1	580	40	5.6	28	\$1,621.05
AR503-GR3/4-GCI	14.3	54.1	580	40	5.6	40	\$2,691.05
AR503-GR1-GCI	14.3	54.1	580	40	5.6	40	\$2,803.40
AR503-GR3/4-GCI/A1	14.3	54.1	580	40	5.6	42	\$2,803.40
AR503-GR1-GCI/A1	14.3	54.1	580	40	5.6	42	\$2,803.40
AR503-AP-C/SP+PC-SGC	14.3	54.1	580	40	5.6	28	\$1,807.82

GCI - Pump with a mounted control unit.



SP Version
Flanged Shaft for Shaft
Kits, Gearboxes, and
Hydraulic Flanges.



GR3/4-GCI Version
Gear Reduction AR1636
with 3/4" Hollow Shaft,
RM40 Control Unit.



GR1-GCI/A1 Version
Gear Reduction AR1639
with 1" Hollow Shaft,
RM40 Control Unit and
25mm Solid Keyed
Thru Shaft.



AR43390
1" straight keyed shaft
with bolts.



Hydraulic Flange Kit
AR43397.
AR503 (SP Models Only).
Fits SAE 2-bolt A Flange
Motors with 1" Shaft.

DIAPHRAGM KITS			VALVE KITS			O-RING KITS			OIL		
MODEL	DESCRIPTION	LIST PRICE	MODEL	DESCRIPTION	LIST PRICE	MODEL	DESCRIPTION	LIST PRICE	MODEL	DESCRIPTION	LIST PRICE
AR43297	BlueFlex	\$121.45	AR1987	Valves	\$213.78	AR1984	O-Rings	\$65.99	AR64532D	Oil	\$16.59
AR43295	Desmopan	\$111.91							AR64532D-C	Case (6)Oil	\$96.30
AR43294	NBR	\$79.79									



AR1666 Gearbox

NEW

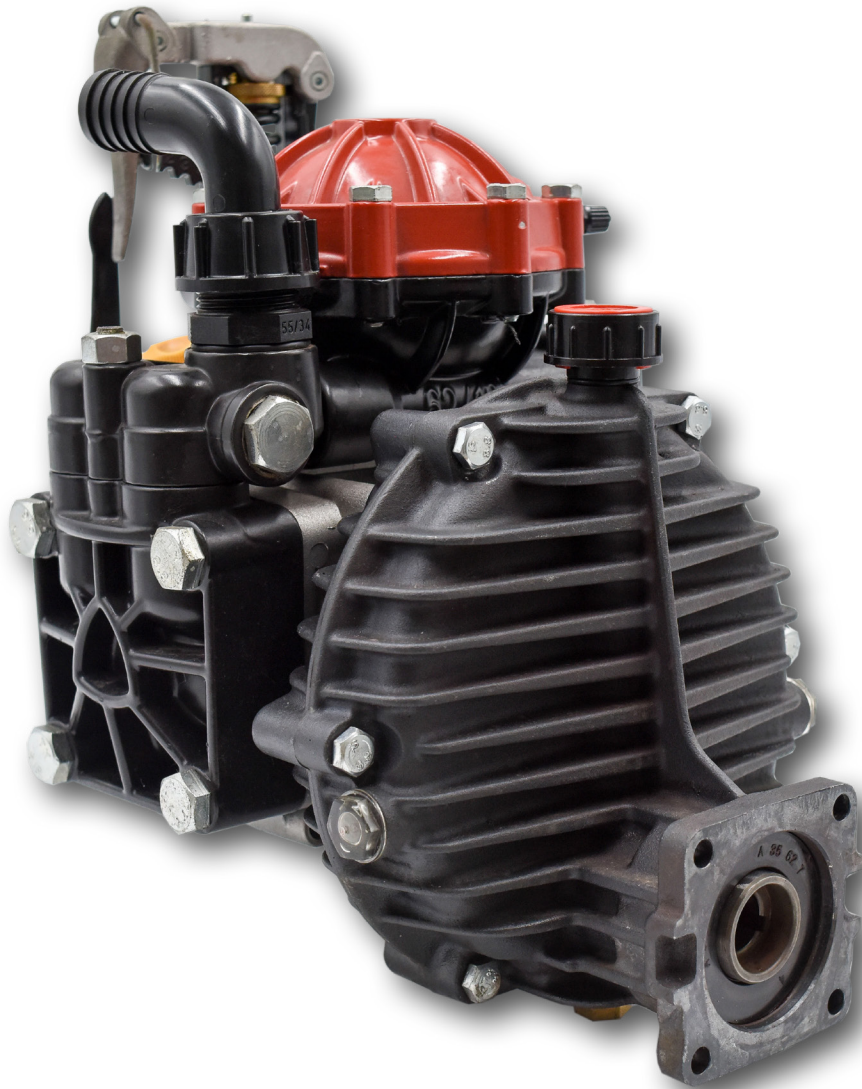

New and Improved Gearbox for 5.5-6.5 HP Gas Engines

Eliminates Gas Engine Shaft and Key Wear
Easy to Service
Runs Cooler for Longer Life
Mounts All Medium Pressure Diaphragm Pumps to Gas Engines with 3/4" Shaft

List Price \$727.60

APPLICABLE MEDIUM PRESSURE DIAPHRAGM PUMPS

AR30

AR40

AR50

AR303

AR403

AR503



Application Kits

Medium Pressure

Gearbox Kit AR1639: 1" 8-18 HP Gas Engines \$799.93



Gearbox for four stroke engines with SAE J609a flange

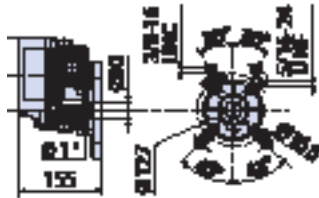

Gearbox Kit AR1636: 3/4" for 5-6HP Gas Engine \$727.60

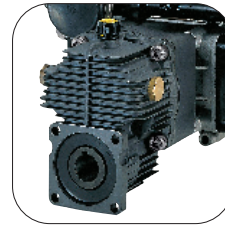

Gearbox for four stroke engines with SAE J609a flange

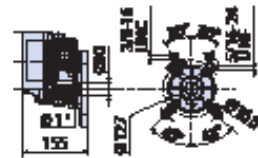

Shaft Kit AR43393: 1 3/8" 6 Male Spline \$195.71

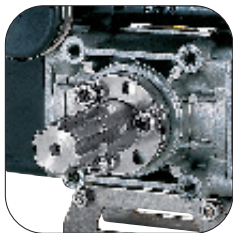

1³/₈ universal shaft



Shaft Kit AR43394: 1 3/8" 6 Female Spline \$142.24

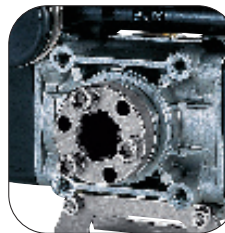

1³/₈ female

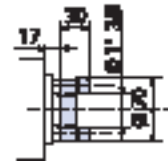

Pulley Kits



Pulley

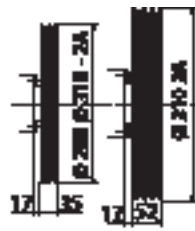

Kit Appl. P AR1504 11" 2A \$193.24

Kit Appl. P AR1495 12.2" 2A \$224.70

Kit Appl. P AR1520 12.2" 3A \$238.18

Hydraulic Motor Flange Kit AR43397 \$348.52



AR43397

For models AR30, AR50, AR303, AR403, AR503 (SP Models Only)

Fits SAE 2-bolt A Flange Motors with 1" Shaft

Shaft Kit: 1" Male Solid Keyed Shaft



AR43387 - for model AR30 \$128.14

AR43388 - for model AR50 \$145.71

AR43390 - for model AR503, AR303, AR403 \$109.25

Kit includes a male PTO shaft adapter, mounting bracket and necessary hardware.

Shaft Kit: 1-3/8" Female PTO Shaft Kit AR1704 \$275.96



For model AR30, AR50



Control Units

Medium Pressure

GR 20 S

Control unit with working pressure regulating valve, by-pass control lever and glycerin filled pressure gauge with colored dial.

- AR252
- AR303, AR403
- 140° F Max Temperature
- 1/2" NPT - Inlet
- 3/4" - Return
- 3/8" - Outlet



MODEL	MAX GPM	MAX L/MIN	MAX PSI	MAX BAR	WEIGHT LBS	LIST PRICE
GR20S	10.6	40	290	20	2.6	\$256.80

GI 30

Control unit with working pressure regulating valve and glycerin filled pressure gauge with colored dial.

- AR252
- 140° F Max Temperature
- 1/2" NPT - Inlet
- 3/4" - Return
- 3/8" - Outlet



Order direct mount kit 973"l" separately

MODEL	MAX GPM	MAX L/MIN	MAX PSI	MAX BAR	WEIGHT LBS	LIST PRICE
GI30	21.1	80	435	30	2.6	\$262.15

AR1912 / AR1990

Remote control unit with working pressure regulating valve, opening/closing control lever, anti drip, valves with pressure discharge regulation.

- AR202, AR252
- 140° F Max Temperature
- 5/8" - Return
- 3/8" - Outlet



AR1912-KIT

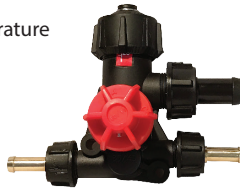

AR1990-KIT

MODEL	MAX GPM	MAX L/MIN	MAX PSI	MAX BAR	WEIGHT LBS	LIST PRICE
AR1912	6.6	25	360	25	1.0	\$158.08
AR1990	6.6	25	360	25	1.0	\$164.10

GI 40 / GIC 40

Control unit with working pressure regulating valve and glycerin filled pressure gauge with colored dial.

- AR30, AR50, AR303
- AR403, AR503
- 140° F Max Temperature
- 1/2" NPT - Inlet
- 3/4" - Return
- 1/2" - Outlet
- GIC40 includes Cataphoresis coated valve body and ceramic relief valve seat

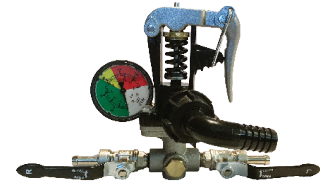

MODEL	MAX GPM	MAX L/MIN	MAX PSI	MAX BAR	WEIGHT LBS	LIST PRICE
GI40	21.1	80	580	40	3.5	\$278.20
GIC40	21.1	80	580	40	3.5	\$278.20

GR 40

Control unit with working pressure regulating valve, by-pass control lever and glycerin filled pressure gauge with colored dial.

- AR303, AR403, AR503
- 140° F Max Temperature
- 1/2" NPT - Inlet
- 3/4" - Return
- 3/8" - Outlet



Order direct mount kit 976"l" and remote mount kit 983"l" separately

MODEL	MAX GPM	MAX L/MIN	MAX PSI	MAX BAR	WEIGHT LBS	LIST PRICE
GR40	10.6	40	580	40	2.6	\$208.65
AR33082*	10.6	40	580	40	2.6	\$471.87

*Lesco Configurations

RM 40

Remote control unit with working pressure regulating valve, by-pass control and glycerin filled pressure gauge with colored dial.

- AR503, AR30, AR50
- 140° F Max Temperature
- 3/4" NPT - Inlet
- 3/4" - Return
- 3/8" - Outlet

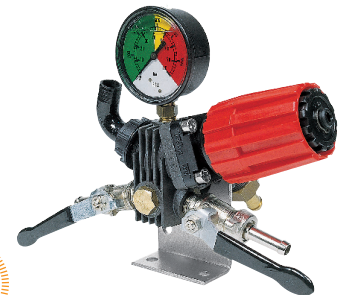

Order direct mount kit 977"l" and remote mount kit 983"l" separately

MODEL	MAX GPM	MAX L/MIN	MAX PSI	MAX BAR	WEIGHT LBS	LIST PRICE
RM40S	21.1	80	580	40	3.5	\$342.40



AR813

Anodized
ALUMINUM

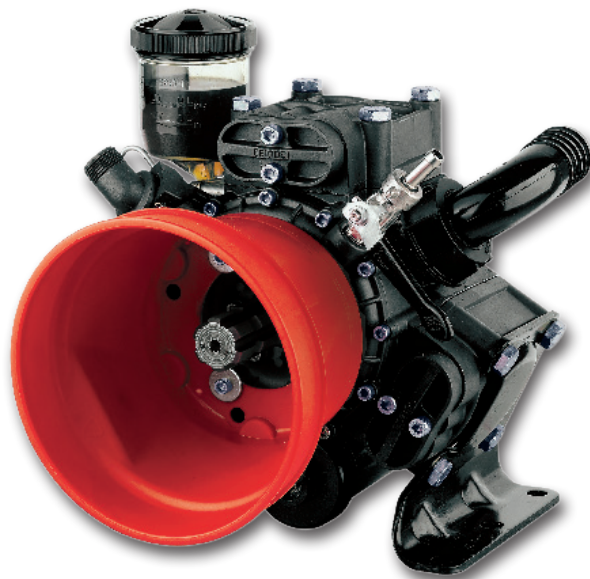

High Pressure

140° F - Max Water Temp
1 1/2" - Suction
3/4" NPT - Outlet

AR813 - 550 RPM - SEMI-HYDRAULIC THREE DIAPHRAGM PUMP

MODEL	MAX GPM	MAX L/MIN	MAX PSI	MAX BAR	HP POWER	WEIGHT LBS.	LIST PRICE
AR813-C/C	21.1	79.9	725	50	9.8	50	\$2,070.45
AR813-C/SP	21.1	79.9	725	50	9.8	49	\$2,097.20
AR813-GR-CPC-GCI	21.1	79.9	725	50	9.8	65	\$3,290.25
AR813-CR1-GCI	21.1	79.9	725	50	9.8	52	\$3,217.49

GCI - Pump with a mounted control unit.



C/C Version
1 3/8" 6 Splined PTO
Thru Shaft.



C/SP Version
SP Version with 1 3/8"
Splined Thru Shaft.



GR-CPC-GCI Version
Gear Reduction AR1639
with 1" Hollow Shaft, VDR50
Control Unit and 1 3/8"
Splined Thru Shaft.



1-3/8" Universal PTO
Shaft Kit for -SP Models
AR43393.



Hydraulic Motor Flange
Kit AR43397. For models
AR813 (SP Models Only).
Fits SAE 2-bolt A Flange
Motors with 1" Shaft.

DIAPHRAGM KITS			VALVE KITS			O-RING KITS			OIL		
MODEL	DESCRIPTION	LIST PRICE	MODEL	DESCRIPTION	LIST PRICE	MODEL	DESCRIPTION	LIST PRICE	MODEL	DESCRIPTION	LIST PRICE
AR43301	BlueFlex	\$140.01	AR1963	Valves	\$211.01	AR43018 (AR713)	O-Rings	\$56.21	AR64532D	Oil	\$16.59
AR43299	Desmopan	\$119.94				AR43020 (AR813)	O-Rings	\$59.21	AR64532D-C	Case (6)Oil	\$96.30
AR43298	NBR	\$111.15									
AR43300	Viton	\$564.56									



AR1053 • AR1203

Anodized
ALUMINUM

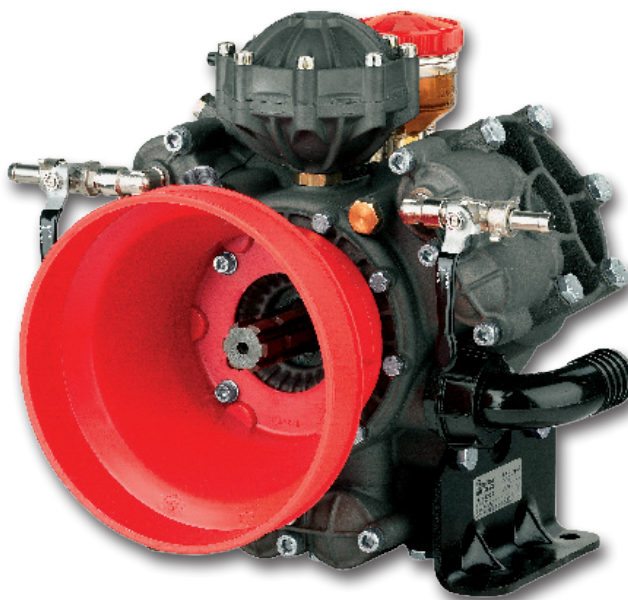

BlueFlex™
Diaphragms

High Pressure

140° F - Max Water Temp
1 1/2" - Suction
3/4" NPT - Outlet

AR1053 • AR1203 - 550 RPM - SEMI-HYDRAULIC THREE DIAPHRAGM PUMP

MODEL	MAX GPM	MAX L/MIN	MAX PSI	MAX BAR	HP POWER	WEIGHT LBS.	LIST PRICE
AR1053-C/C	27.1	102.4	725	50	12.1	75	\$2,653.60
AR1053-C/SP	27.1	102.4	725	50	12.1	76	\$2,696.40
AR1203-C/C	30.6	115.8	725	50	13.6	75	\$2,787.35
AR1203-C/SP	30.6	115.8	725	50	13.6	76	\$2,830.15



C/C Version
1 3/8" Splined Thru Shaft.



C/SP Version
SP Version with 1 3/8" Splined
Thru Shaft.



Hydraulic Motor Flange Kit
AR43397. For models AR1053,
1203(SP Models Only). Fits SAE
2-bolt A Flange Motors with
1" Shaft.

DIAPHRAGM KITS			VALVE KITS			O-RING KITS			OIL		
MODEL	DESCRIPTION	LIST PRICE	MODEL	DESCRIPTION	LIST PRICE	MODEL	DESCRIPTION	LIST PRICE	MODEL	DESCRIPTION	LIST PRICE
AR43309	BlueFlex	\$149.04	AR42200	Valves	\$241.88	AR42201	O-Rings	\$37.64	AR64532D	Oil	\$16.59
AR43307	Desmopan	\$114.92							AR64532D-C	Case (6)Oil	\$96.30
AR43306	NBR	\$114.92									
AR43308	Viton	\$983.59									



AR1064

Anodized
ALUMINUM



High Pressure

140° F - Max Water Temp
1 1/2" - Suction
3/4" NPT - Outlet

AR1064 - 550 RPM - SEMI-HYDRAULIC FOUR DIAPHRAGM PUMP

MODEL	MAX GPM	MAX L/MIN	MAX PSI	MAX BAR	HP POWER	WEIGHT LBS.	LIST PRICE
AR1064-C/C	28.7	108.5	725	50	13.1	51.8	\$2,316.55
AR1064-C/SP	28.7	108.5	725	50	13.1	58	\$2,337.95
AR1064-GR1-GCI	28.7	108.5	725	50	13.1	72	\$3,367.29
AR1064-SP-GCI	28.7	108.5	725	50	13.1	66	\$2,947.85

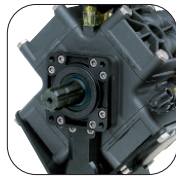

C/C Version
1 3/8" 6 Splined Thru Shaft.

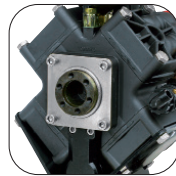

C/SP Version
SP Version with 1 3/8" Splined
Thru Shaft.



Hydraulic Motor Flange Kit
AR43397. For models AR1064
(SP Models Only). Fits SAE
2-bolt A Flange Motors
with 1" Shaft

DIAPHRAGM KITS			VALVE KITS			O-RING KITS			OIL		
MODEL	DESCRIPTION	LIST PRICE	MODEL	DESCRIPTION	LIST PRICE	MODEL	DESCRIPTION	LIST PRICE	MODEL	DESCRIPTION	LIST PRICE
AR43305	BlueFlex	\$209.76	AR1964	Valves	\$279.01	AR43022	O-Rings	\$58.71	AR64532D	Oil	\$16.59
AR43303	Desmopan	\$144.02							AR64532D-C	Case (6)Oil	\$96.30
AR43302	NBR	\$132.49									
AR43304	Viton	\$735.19									



AR1604

A n o d i z e d
A L U M I N U M



High Pressure

140° F - Max Water Temp
1 1/2" - Suction
3/4" NPT - Outlet

AR1604 - 550 RPM - SEMI-HYDRAULIC FOUR DIAPHRAGM PUMP

MODEL	MAX GPM	MAX L/MIN	MAX PSI	MAX BAR	HP POWER	WEIGHT LBS.	LIST PRICE
AR1604-C/C	40.4	153	725	50	18.6	87	\$3,290.25
AR1604N-C/SP	40.4	153	725	50	18.6	90	\$4,536.80



C/C Version
1 3/8" 6 Splined Thru Shaft.

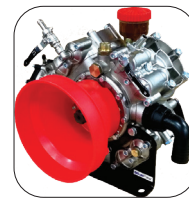

C/SP Version SP Version with
1 3/8" Splined Thru Shaft.

DIAPHRAGM KITS			VALVE KITS			O-RING KITS			OIL		
MODEL	DESCRIPTION	LIST PRICE	MODEL	DESCRIPTION	LIST PRICE	MODEL	DESCRIPTION	LIST PRICE	MODEL	DESCRIPTION	LIST PRICE
AR43313	BlueFlex	\$209.76	AR42941	Valves	\$308.63	AR42942	O-Rings	\$30.86	AR64532D	Oil	\$16.59
AR43311	Desmopan	\$140.27							AR64532D-C	Case (6)Oil	\$96.30
AR43310	NBR	\$141.02									
AR43312	Viton	\$1,249.56									



BHA130 • BHA150

A n o d i z e d
A L U M I N U M

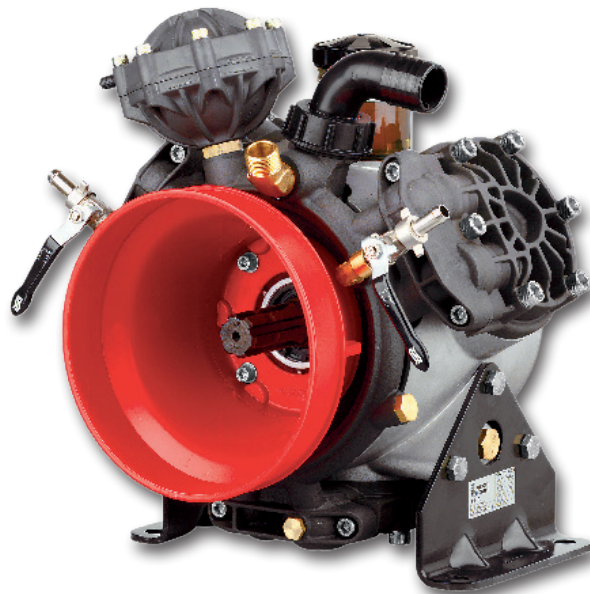

High Pressure

140° F - Max Water Temp
1 1/2" - Suction
3/4" GAS - Outlet

BHA130 • BHA150 - 550 RPM - SEMI-HYDRAULIC THREE DIAPHRAGM PUMP

MODEL	MAX GPM	MAX L/MIN	MAX PSI	MAX BAR	HP POWER	WEIGHT LBS.	LIST PRICE
BHA130-C/C	33.7	127.5	725	50	14.5	93	\$3,397.25
BHA150-C/C	37.7	142.6	725	50	16.3	93	\$3,718.25



C/C Version
1 3/8" 6 Splined Thru Shaft.

DIAPHRAGM KITS			VALVE KITS			O-RING KITS			OIL		
MODEL	DESCRIPTION	LIST PRICE	MODEL	DESCRIPTION	LIST PRICE	MODEL	DESCRIPTION	LIST PRICE	MODEL	DESCRIPTION	LIST PRICE
AR43320	BlueFlex	\$173.89	AR2445	Valves	\$295.58	AR2446	O-Rings	\$36.13	AR64532D	Oil	\$16.59
AR43319	Desmopan	\$179.41							AR64532D-C	Case (6)Oil	\$96.30
AR43318	NBR	\$132.99									



BHA170 • BHA200

A n o d i z e d
A L U M I N U M



High Pressure

140° F - Max Water Temp
1 1/2" - Suction
3/4" GAS - Outlet

BHA170 • BHA200 - 550 RPM - SEMI-HYDRAULIC FOUR DIAPHRAGM PUMP

MODEL	MAX GPM	MAX L/MIN	MAX PSI	MAX BAR	HP POWER	WEIGHT LBS.	LIST PRICE
BHA170-C/C	42.4	160.4	725	50	19.3	115	\$4,162.30
BHA200-C/C	51.2	193.7	725	50	22.1	115	\$4,815.00



C/C Version
1 3/8" 6 Splined Thru Shaft.

DIAPHRAGM KITS			VALVE KITS			O-RING KITS			OIL		
MODEL	DESCRIPTION	LIST PRICE	MODEL	DESCRIPTION	LIST PRICE	MODEL	DESCRIPTION	LIST PRICE	MODEL	DESCRIPTION	LIST PRICE
AR43323	BlueFlex	\$226.33	AR2374	Valves	\$400.46	AR2457	O-Rings	\$40.65	AR64532D	Oil	\$16.59
AR43322	Desmopan	\$294.36							AR64532D-C	Case (6)Oil	\$96.30
AR43321	NBR	\$216.46									



BHP130 • BHP150

Plastic Coated
ALUMINUM

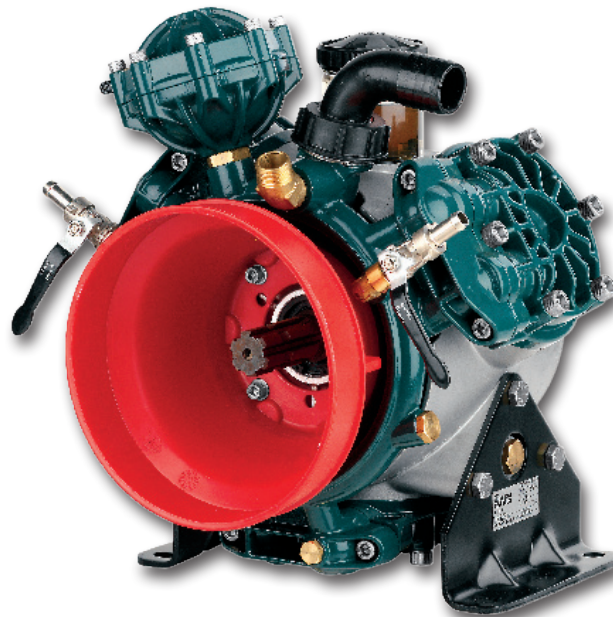

High Pressure

140° F - Max Water Temp
1 1/2" - Suction
3/4" GAS - Outlet

BHP130 • BHP150 - 550 RPM - SEMI-HYDRAULIC THREE DIAPHRAGM PUMP

MODEL	MAX GPM	MAX L/MIN	MAX PSI	MAX BAR	HP POWER	WEIGHT LBS.	LIST PRICE
BHP130-C/C	33.7	127.5	725	50	14.5	94	\$3,531.00
BHP150-C/C	37.7	142.6	725	50	16.3	94	\$3,852.00



C/C Version
1 3/8" 6 Splined Thru Shaft.

DIAPHRAGM KITS			VALVE KITS			O-RING KITS			OIL		
MODEL	DESCRIPTION	LIST PRICE	MODEL	DESCRIPTION	LIST PRICE	MODEL	DESCRIPTION	LIST PRICE	MODEL	DESCRIPTION	LIST PRICE
AR43320	BlueFlex	\$173.89	AR2445	Valves	\$295.58	AR2446	O-Rings	\$36.13	AR64532D	Oil	\$16.59
AR43319	Desmopan	\$179.41							AR64532D-C	Case (6)Oil	\$96.30
AR43318	NBR	\$132.99									



BHP170 • BHP200

Plastic Coated
ALUMINUM

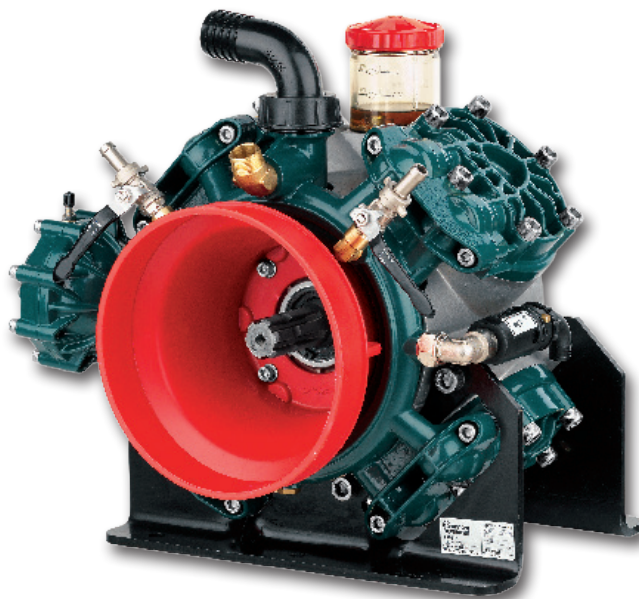

High Pressure

140° F - Max Water Temp
1 1/2" - Suction
3/4" GAS - Outlet

BHP170 • BHP200 - 550 RPM - SEMI-HYDRAULIC FOUR DIAPHRAGM PUMP

MODEL	MAX GPM	MAX L/MIN	MAX PSI	MAX BAR	HP POWER	WEIGHT LBS.	LIST PRICE
BHP170-C/C	42.4	160.4	725	50	19.3	115	\$4,670.55
BHP200-C/C	51.2	193.7	725	50	22.1	115	\$4,991.55



C/C Version
1 3/8" 6 Splined Thru Shaft.

DIAPHRAGM KITS			VALVE KITS			O-RING KITS			OIL		
MODEL	DESCRIPTION	LIST PRICE	MODEL	DESCRIPTION	LIST PRICE	MODEL	DESCRIPTION	LIST PRICE	MODEL	DESCRIPTION	LIST PRICE
AR43323	BlueFlex	\$226.33	AR2374	Valves	\$400.46	AR2457	O-Rings	\$40.65	AR64532D	Oil	\$16.59
AR43322	Desmopan	\$294.36							AR64532D-C	Case (6)Oil	\$96.30
AR43321	NBR	\$216.46									



BHS90 • BHS105 • BHS120

S e r i e s
B R A S S

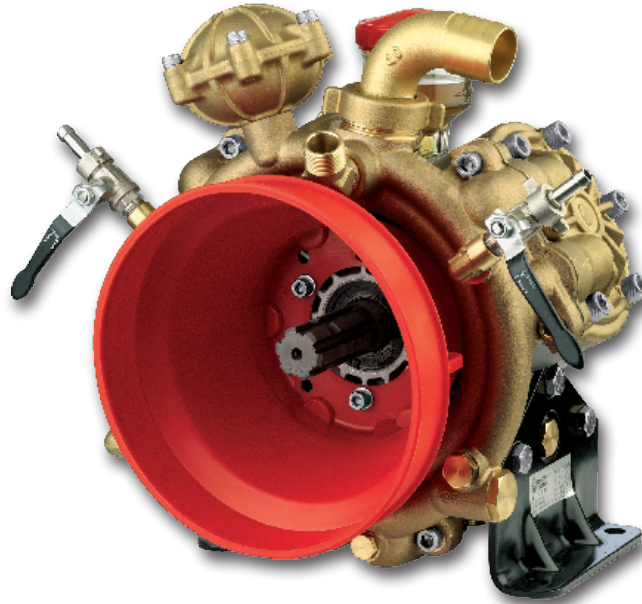

High Pressure

140° F - Max Water Temp
1 1/2" - Suction
3/4" GAS - Outlet

BHS90 • BHS105 • BHS120 - 550 RPM - SEMI-HYDRAULIC FOUR DIAPHRAGM PUMP

MODEL	MAX GPM	MAX L/MIN	MAX PSI	MAX BAR	HP POWER	WEIGHT LBS.	LIST PRICE
BHS90-C/C	23.9	90.6	725	50	10.5	100	\$4,039.25
BHS105-C/C	26.9	101.9	725	50	12.0	100	\$4,360.25
BHS120-C/C	29.8	113.0	725	50	13.3	100	\$4,526.10



C/C Version
1 3/8" 6 Splined Thru Shaft.

DIAPHRAGM KITS			VALVE KITS			O-RING KITS			OIL		
MODEL	DESCRIPTION	LIST PRICE	MODEL	DESCRIPTION	LIST PRICE	MODEL	DESCRIPTION	LIST PRICE	MODEL	DESCRIPTION	LIST PRICE
AR43317	BlueFlex	\$149.04	AR2445	Valves	\$295.58	AR42205	O-Rings	\$32.87	AR64532D	Oil	\$16.59
AR43315	Desmopan	\$113.41							AR64532D-C	Case (6)Oil	\$96.30
AR43314	NBR	\$113.41									
AR43316	Viton	\$953.48									



BHS130 • BHS150

S e r i e s
B R A S S

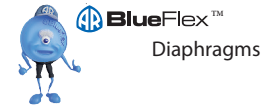
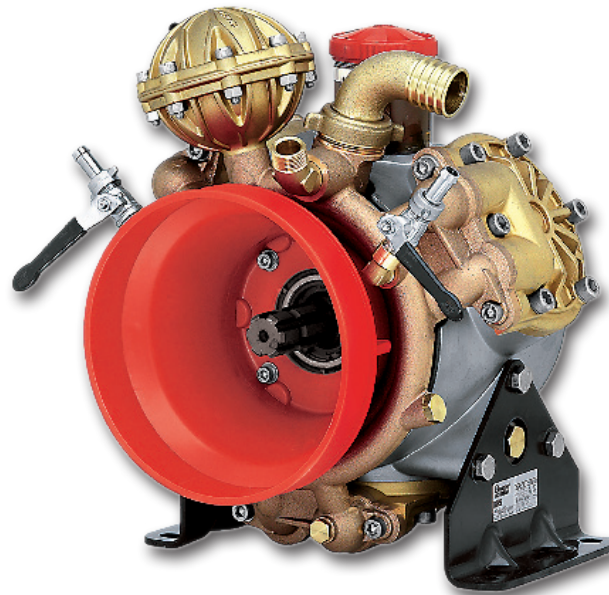

High Pressure

140° F - Max Water Temp
1 1/2" - Suction
3/4" GAS - Outlet

BHS130 • BHS150 - 550 RPM - SEMI-HYDRAULIC THREE DIAPHRAGM PUMP

MODEL	MAX GPM	MAX L/MIN	MAX PSI	MAX BAR	HP POWER	WEIGHT LBS.	LIST PRICE
BHS130-C/C	33.7	127.5	725	50	14.5	124	\$4,761.50
BHS150-C/C	37.7	142.6	725	50	16.3	124	\$4,879.20



C/C Version
1 3/8" 6 Splined Thru Shaft.

DIAPHRAGM KITS			VALVE KITS			O-RING KITS			OIL		
MODEL	DESCRIPTION	LIST PRICE	MODEL	DESCRIPTION	LIST PRICE	MODEL	DESCRIPTION	LIST PRICE	MODEL	DESCRIPTION	LIST PRICE
AR43320	BlueFlex	\$173.89	AR2445	Valves	\$295.58	AR2446	O-Rings	\$36.13	AR64532D	Oil	\$16.59
AR43319	Desmopan	\$179.41							AR64532D-C	Case (6)Oil	\$96.30
AR43318	NBR	\$132.99									



BHS170 • BHS200

S e r i e s
B R A S S

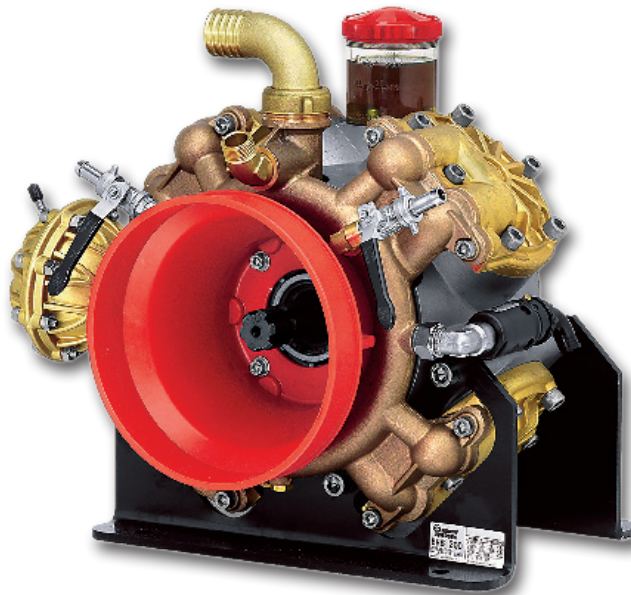

High Pressure

140° F - Max Water Temp
1 1/2" - Suction
3/4" GAS - Outlet

BHS170 • BHS200 - 550 RPM - SEMI-HYDRAULIC FOUR DIAPHRAGM PUMP

MODEL	MAX GPM	MAX L/MIN	MAX PSI	MAX BAR	HP POWER	WEIGHT LBS.	LIST PRICE
BHS170-C/C	42.4	160.4	725	50	19.3	153	\$5,724.50
BHS200-C/C	51.2	193.7	725	50	22.1	153	\$6,093.65



C/C Version
1 3/8" 6 Splined Thru Shaft.

DIAPHRAGM KITS			VALVE KITS			O-RING KITS			OIL		
MODEL	DESCRIPTION	LIST PRICE	MODEL	DESCRIPTION	LIST PRICE	MODEL	DESCRIPTION	LIST PRICE	MODEL	DESCRIPTION	LIST PRICE
AR43323	BlueFlex	\$226.33	AR2374	Valves	\$400.46	AR2457	O-Rings	\$40.65	AR64532D	Oil	\$16.59
AR43322	Desmopan	\$294.36							AR64532D-C	Case (6)Oil	\$96.30
AR43321	NBR	\$216.46									



Application Kits

High Pressure

Shaft Kit AR43393: 1 3/8" - 6 Male Spline \$195.71



1³/₈ universal shaft

For Models: AR813, AR1064, AR1053, AR1203 and AR1604

Shaft Kit AR43394: 1 3/8" - 6 Female Spline \$142.24



1³/₈ female

Pulley Kits



Pulley

Kit Appl.P cod.1516 12.2" 3A For Model: AR813 \$238.18

Kit Appl.P cod.1520 12.2" 3A For Model: AR1064 \$238.18

Hydraulic Motor Flange Kit \$348.52



AR43397

For models AR813, AR1053, AR1203, AR1064 (SP Models Only)

Fits SAE 2-bolt A Flange Motors with 1" Shaft

Gearbox Kit AR1639: 1" 8-18HP Gas Engine \$799.93



Gearbox for four stroke engines with SAE J609a flange with 1" shaft

Shaft Kit AR43391: 1" Male Solid Keyed Shaft \$114.17



For models: AR813, AR1064, and AR1265

Kit includes a male PTO shaft adapter, mounting bracket and necessary hardware.



Control Units

High Pressure

VDR 50

Control unit with working pressure regulating valve, by-pass opening/closing control lever and glycerin filled pressure gauge with colored dial.

- BHA-BHP130
- BHS90-105-120
- AR503, AR30, AR50
- AR813, AR1064
- AR1053, AR1203
- 140° F Max Temperature
- 3/4" NPT - Inlet
- 3/4" - Return
- 3/8" - Outlet

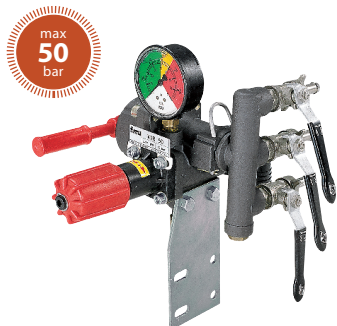

MODEL	MAX GPM	MAX L/MIN	MAX PSI	MAX BAR	WEIGHT LBS	LIST PRICE
VDR50	34.3	130	725	50	4.9	\$609.90

BMS 50

Brass control unit with working pressure regulating valve, single lever for partial or total closure and discharge, and glycerin filled pressure gauge with colored dial.

- BHS90-105-120-130
- BHS150-170-200
- 140° F Max Temperature
- 3/4" GAS - Inlet
- 1" - Return
- 1/2" - Outlet

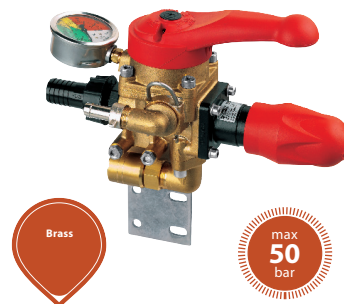

MODEL	MAX GPM	MAX L/MIN	MAX PSI	MAX BAR	WEIGHT LBS	LIST PRICE
BMS50	52.8	300	725	50	11	\$925.55

BY MATIC 50

Control unit with working pressure regulating valve, single lever for partial or total closure and discharge, and glycerin filled pressure gauge with colored dial.

- BHA-BHP130-150-170-200
- AR813, AR1064
- AR1053, AR1604
- 140° F Max Temperature
- 3/4" GAS - Inlet
- 1" - Return
- 1/2" - Outlet



MODEL	MAX GPM	MAX L/MIN	MAX PSI	MAX BAR	WEIGHT LBS	LIST PRICE
MATIC50	52.8	200	725	50	6	\$695.50

GH 50 / GI 50

Brass control unit with working pressure regulating valve, single lever for partial or total by-pass opening and closure, and glycerin filled pressure gauge with colored dial.

- BHA130-150-170-200
- BHP130-150-170-200
- BHS90-105-120-130
- BHS150-170-200
- 140° F Max Temperature
- 3/4" GAS - Inlet
- 1" - Return
- 1/2" - Outlet
- GI 50 includes mounting manifold, gauge and outlet ball valve for AR813 - AR1064



MODEL	MAX GPM	MAX L/MIN	MAX PSI	MAX BAR	WEIGHT LBS	LIST PRICE
GH50	52.8	200	725	50	8.4	\$545.70
GI50	52.8	200	725	50	9.5	\$443.19

BMH 50

Brass control unit with working pressure regulating valve, single lever for partial or total closure and discharge, and glycerin filled pressure gauge with colored dial.

- BHA-BHP130-150-170-200
- BHS90-105-120-130
- BHS150-170-200
- AR813, AR1064
- AR1053, AR1203
- AR1604
- 140° F Max Temperature
- 3/4" GAS - Inlet
- 1" - Return
- 1/2" - Outlet

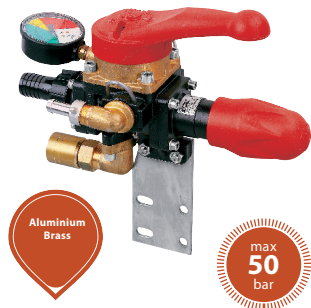

MODEL	MAX GPM	MAX L/MIN	MAX PSI	MAX BAR	WEIGHT LBS	LIST PRICE
BMH50	52.8	200	725	50	6.8	\$775.75

VH 50

Brass control unit with working pressure regulating valve, and glycerin filled pressure gauge with colored dial.

- BHA-BHP130-150-170-200
- BHS90-105-120-130
- BHS150-170-200
- AR813, AR1064
- AR1053-1203-1604
- 140° F Max Temperature
- 3/4" GAS - Inlet
- 1" - Return
- 1/2" - Outlet



MODEL	MAX GPM	MAX L/MIN	MAX PSI	MAX BAR	WEIGHT LBS	LIST PRICE
VH50	52.8	200	72.5	60	5.5	\$428.00



AGRICULTURE ACCESSORIES

Annovi Reverberi manufactures diaphragm pumps for crop protection spraying applications. The best indication of our success is the trust that our many clients all over the world have placed in us. As the market for spraying pumps evolves, we are working on new pump models for further extend our already wide range.

With an annual production output of approximately 1,000,000 pumps Annovi Reverberi currently represents an ever-expanding concern with a strong presence in the Italian, European, and world markets with exports consisting of around 80% of overall turnover.

AR - a reliable partner which has always firmly believed in the importance of reciprocal collaboration and a relationship based on trust with its customers.





Accessories

TABLE OF CONTENTS

Magnetic Induction Flowmeters	P 54	Clamps	P 73
Rapid Check Flowmeters	P 54 - 56	Clamps	P 83
Pro Flow 12V Magnetic Flowmeter	P 54	Nozzle Body Adapters	P 84
Magnetic Sensors	P 56	Nozzle Body Accessories	P 84 - 86
SS Turbine Flowmeter with Display	P 57	High Pressure Nozzle Bodies	P 88 - 91
Pony Flow Display	P 57	Butterfly Nozzles	P 91
Mini Flowmeter	P 57	Orchard Sprayer Nozzles	P 92
Economical Manual Valves	P 58	Line Brass Filters	P 92
Long Range Adjustable Spray Guns	P 59	Agricultural High Pressure Spray Lances	P 93
Pistol Grip Adjustable Spray Guns	P 60	Butterfly Nozzles	P 93
Sprayer Accessories	P 61	Pressure Relief Valve	P 94
Root Feeders	P 61	Pressure Regulator Valve	P 94
Spray Gun Accessories	P 62	Tank & Container Rinsing Rotating Nozzles	P 94
Spray Gun Nozzles & Performance Chart	P 62	Powder Mixing Accessories	P 95
Adjustable Spraying Gun	P 63	Sprayer Control	P 96
Spot Spraying Guns	P 63	Check Valve	P 96
Agricultural Spot ATV Spray Gun	P 64	Installation Tools	P 96
Low Pressure 12V Spray Guns	P 64	Bulk Head Fittings	P 96
Tank Lids, Basket Filters & Accessories	P 65 - 67	Clamps	P 97
Tank Accessories	P 68	Ball Valve	P 97
Jet Agitator	P 69	Cam Lock Couplers	P 98 - 100
Ball Valves	P 70	12V Diaphragm Pump	P 101
Line Strainers	P 71 - 72	Low Pressure 12V Spray Guns	P 101
Nozzle Bodies	P 73 - 87	Pump Package Options	P 102



Accessories

MAGNETIC INDUCTION FLOWMETERS

Magnetic Induction Flowmeters with no internal moving parts features advanced technology to accurately measure flow independent of viscosity and density. Suitable for all water based liquid chemicals. 12VDC Operation. Amp Super Seal 1.5 electrical plug.



FLOWMETER ONLY

MODEL	MATERIAL	THREADED CONNECTION*	FLOW RANGE	MAX. PRESSURE	LIST PRICE
AGFM377050	Polypropylene	3/4" BSP M	0.26 - 3.9 GPM	700 PSI	\$1,430.06
AGFM377052	Polypropylene	3/4" BSP M	0.79 - 15.8 GPM	700 PSI	\$1,361.96
AGFM377053	Polypropylene	1" NPT M	2.6 - 52 GPM	700 PSI	\$1,361.96
AGFM377055	Polypropylene	1 1/2" NPT M	5.3 - 105 GPM	580 PSI	\$1,571.30
AGFM377060	Polypropylene	2" NPT M	11.8 - 237 GPM	290 PSI	\$1,630.99

Accuracy \pm 1% within specified flow

FLOWMETER WITH DISPLAY

MODEL	MATERIAL	THREADED CONNECTION*	FLOW RANGE	MAX. PRESSURE	LIST PRICE
AGFMM377050	Polypropylene	3/4" NPT M	0.26 - 3.9 GPM	700 PSI	\$1,361.96
AGFMM377052	Polypropylene	3/4" NPT M	0.79 - 15.8 GPM	700 PSI	\$1,361.96
AGFMM377053	Polypropylene	1" NPT M	2.6 - 52 GPM	700 PSI	\$1,361.96
AGFMM377055	Polypropylene	1 1/2" NPT M	5.3 - 105 GPM	580 PSI	\$1,496.47
AGFMM377060	Polypropylene	2" NPT M	11.8 - 237 GPM	290 PSI	\$1,630.99

Accuracy \pm 1% within specified flow

*Other threaded and flanged connections are available. Consult Factory.
Electrical connections are available for all rate controllers. Consult Factory.

RAPID CHECK FLOWMETERS

Rapid Check Flowmeters feature accurate flow measurement with ease of maintenance. Flowmeters are available in wide selection of sizes to meet customer requirements. Note that the magnetic sensors are sold separately, and are available in square wave, amplified square wave, sine wave, or hall effect models with a variety of electrical connectors.



MODEL	MATERIAL	HOSE BARB SIZE	FLOW RANGE	MAX. PRESSURE	SUPPORTS	LIST PRICE
AGFM78001-PKG	Nylon	1/2"	0.8 - 7.9 GPM	290 PSI	Ceramic	\$468.75
AGFM78051-PKG	Nylon	3/4"	1.8 - 18 GPM	290 PSI	Ceramic	\$482.62
AGFM75031-PKG	Nylon	1"	2.6 - 26 GPM	290 PSI	Ceramic	\$577.32
AGFM75252-PKG	Nylon	1 1/4"	4.5 - 45 GPM	290 PSI	Ceramic	\$579.68
AGFM75041-PKG	Nylon	1 1/2"	9.3 - 92 GPM	290 PSI	Ceramic	\$582.62
AGFM76008-PKG	Nylon	2"	19.8 - 194 GPM	290 PSI	Ceramic	\$766.30

Accuracy \pm 1% within specified flow

Magnetic sensors sold separately

PRO FLOW 12V MAGNETIC FLOWMETER WITH PROGRAMMABLE STOP

Pro-Flow 12V is a magnetic flow meter with a programmable automatic stop feature. When the programmed total flow is reached, the ball valve shuts off. A 12V output feature can be used to energize a solenoid to turn off the pump when the programmed amount of flow is reached.



MODEL	MATERIAL	CONNECTION	FLOW RANGE	MAX PRESSURE	LIST PRICE
AGPF379011.1-BF220	Nylon	220 Banjo Flange	12 - 237 GPM	45 PSI	\$3,589.85

Accuracy \pm 1% within specified flow



Accessories

RAPID CHECK FLOWMETERS

Feature Removable Turbine Flowmeter

The Rapid Check flowmeter series features ease of maintenance, while maintaining the precision of the standard turbine flowmeters. It is possible to simply unscrew the body to remove, check, and (if necessary) clean the axial flow turbine. Sensors sold separately.

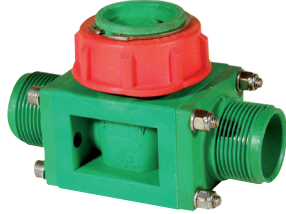

MODEL	MATERIAL	CONNECTION	FLOW RANGE	MAX PRESSURE	LIST PRICE
AGFM5804.1	Nylon	3/4" NPT M	2.6-26.6 GPM	725 PSI	\$567.51
AGFM5804.2	Nylon	1" NPT M	2.6-26.6 GPM	725 PSI	\$567.51
AGFM5804.3	Nylon	TeeJet Flange	2.6-26.6 GPM	725 PSI	\$567.51
AGFM5804.4	Nylon	M100 Universal	2.6-26.6 GPM	725 PSI	\$567.51

Accuracy $\pm 1\%$ within specified flow range

* Other threaded and flanged connections are available. Consult Factory.

Electrical Connections are Available for all Rate Controllers. Consult Factory.

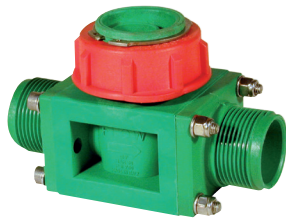

MODEL	MATERIAL	CONNECTION	FLOW RANGE	MAX PRESSURE	LIST PRICE
AGFM6252.1	Nylon	1 1/2" NPT M	4.5-45 GPM	580 PSI	\$719.19
AGFM6252.2	Nylon	M100 Universal	4.5-45 GPM	580 PSI	\$719.19
AGFM6204.1	Nylon	1 1/2" NPT M	9.2-92 GPM	580 PSI	\$719.19
AGFM6204.2	Nylon	M100 Universal	9.2-92 GPM	580 PSI	\$719.19

Accuracy $\pm 1\%$ within specified flow range

* Other threaded and flanged connections are available. Consult Factory.

Electrical Connections are Available for all Rate Controllers. Consult Factory.

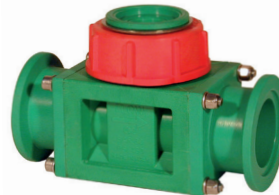
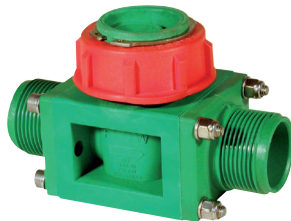

MODEL	MATERIAL	CONNECTION	FLOW RANGE	MAX PRESSURE	LIST PRICE
AGFM6004.1	Nylon	2" NPT M	19.8-198 GPM	435 PSI	\$872.44
AGFM6004.2	Nylon	M200 Universal	19.8-198 GPM	435 PSI	\$872.44

Accuracy $\pm 1\%$ within specified flow range

* Other threaded and flanged connections are available. Consult Factory

Electrical Connections are Available for all Rate Controllers. Consult Factory.



Accessories

RAPID CHECK FLOWMETER



MODEL	MATERIAL	CONNECTION	FLOW RANGE	MAX PRESSURE	LIST PRICE
AGFM6008.1	Nylon	M220 Universal	19.8-198 GPM	290 PSI	\$726.54
Accuracy \pm 1% within specified flow range					



Nylon Body

MODEL	MATERIAL	CONNECTION	FLOW RANGE	MAX PRESSURE	LIST PRICE
AGFM5238.1	Nylon	TeeJet	2.6-26 GPM	290 PSI	\$450.83
Accuracy \pm 1% within specified flow range					

MAGNETIC SENSORS

Rugged and reliable non-contact magnetic sensors available in square wave, sine wave and hall effect versions. Optional connector styles and wire lengths available.

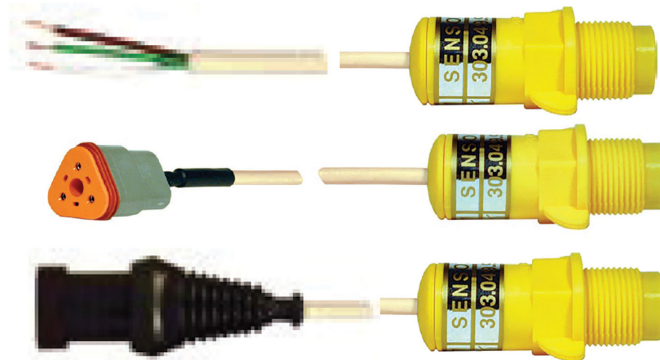

MODEL	TYPE	CONNECTION	WIRE LENGTH	LIST PRICE
AGFMS41300399	Amplified Square Wave	Three Wire	6.5 Feet	\$237.07
AGFMS41300399.DUE	Amplified Square Wave	DEUTSCH	6.5 Feet	\$273.55
AGFMS41300399.2AM	Amplified Square Wave	SuperSeal 1.5	6.5 Feet	\$273.55



Accessories

STAINLESS STEEL TURBINE FLOWMETER WITH DISPLAY

316 Stainless Steel Flow Meter with Stainless Steel Flow straighteners. Ceramic bearing supports. Suitable for measuring corrosive and abrasive liquid chemicals at high pressure, up to 850 PSI at $\pm 1\%$ accuracy.



MODEL	FLOW RANGE	CONNECTIONS	MAX PSI	LIST PRICE
AGFM0320	1.8 GPM - 18 GPM	1" NPT (M)	870	\$951.23
AGFM0325	2.6 GPM - 26 GPM	1 1/4" NPT (M)	870	\$1,024.50
AGFM0335	9.0 GPM - 92 GPM	1 1/2" NPT (M)	870	\$1,217.33
AGFM0345	19.8 GPM - 198 GPM	2" NPT (M)	870	\$1,627.08
AGFM0355	26 GPM - 264 GPM	2 1/2" NPT (M)	870	\$1,971.86
AGFM0365	39 GPM - 396 GPM	3" NPT (M)	870	\$2,354.00
AGFM0385	79 GPM - 792 GPM	4" NPT (M)	870	\$3,546.29
AGFM0395	119 GPM - 1190 GPM	5" NPT (M)	870	\$4,448.14

Display sold separately AGFMD9016.2

PONY FLOW DISPLAY

Programmable multilingual graphic display can indicate: Flow rate in different units (GPM, LPM) cumulative volume delivered (resettable), cumulative volume delivered (not resettable). It can be applied to all A/R turbine flowmeters. Maximum reading error: $\pm 1\%$. Back lit display 9 Volts battery powered. Equipped with luminosity sensor to increase endurance and energy saving.



MODEL	DESCRIPTION	LIST PRICE
AGFMD9016.2	Pony Flow 5 Display, 9V Operation, Rapid Check Flowmeters	\$875.33

MINI FLOWMETER

Radial turbine nylon flowmeter for low flow rates. Two versions are available depending on flow range required. Proximity sensor with LED light to indicate operation. 12VDC Operation. Accuracy is $\pm 1\%$. Does not come with magnetic sensor shown. Order Magnetic sensors separately.



MODEL	FLOW RANGE	MAX PRESSURE	SUPPORTS	HOSE BARBS	LIST PRICE
AGFM5702.1	0.08 - 1.58 GPM	290 PSI	Tungsten Carbide	3/8" Hose Barbs included	\$264.83
AGFM5702.2	1.0 - 5.28 GPM	290 PSI	Tungsten Carbide	1/2" Hose Barbs included	\$264.83



MODEL	DESCRIPTION	LIST PRICE
AGFMS8899	Proximity Sensor, Square Wave, Three Wire 12V for mini flowmeter	\$237.07



ECONOMICAL MANUAL VALVES

A/R Manual Valves are compact, easy to use sprayer controls.

These valves are modular, with 2, 3, 4 or 6 section valves, with optional relief valves, gauges, and on-off valves available.



Economical Three Section Manual Sprayer Control

MODEL	GPM	PSI	SECTION VALVES	INLET	LIST PRICE
AG8374C0040	20	300	(3) 1/2" HB	1/2" HB	\$259.80

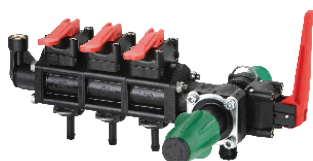

Three Section Boom Sprayer Control with Relief Valve and Main On-Off Valve

MODEL	GPM	PSI	SECTION VALVES	INLET	LIST PRICE
AG8511012	50	300	(3) 1/2" HB	1" NPTF	\$458.25



Three Section Boom Sprayer Control with Relief Valve, Self Cleaning Filter and Main On-Off Valve

MODEL	GPM	PSI	SECTION VALVES	INLET	LIST PRICE
AG8513011	50	300	(3) 1/2" HB	1" NPTF	\$521.29



Economical Two Section Manual Sprayer Control with Flow Control and Gauge

MODEL	GPM	PSI	SECTION VALVES	INLET	LIST PRICE
AG8372C0135	20	300	(2) 1/2" HB	1/2" HB	\$418.61

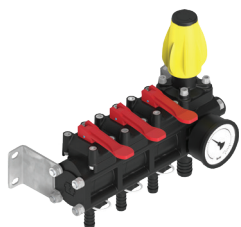

Economical Three Section Manual Sprayer Control with Flow Control and Gauge

MODEL	GPM	PSI	SECTION VALVES	INLET	LIST PRICE
AG8372C0136	20	300	(3) 1/2" HB	1/2" HB	\$479.14

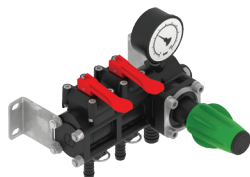

Economical Two Section Manual Sprayer Control with Relief Valve and Gauge

MODEL	GPM	PSI	SECTION VALVES	INLET	LIST PRICE
AG8374C0052	20	300	(2) 1/2" HB	1/2" HB	\$416.18

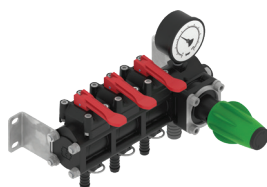

Economical Three Section Manual Sprayer Control with Relief Valve and Gauge

MODEL	GPM	PSI	SECTION VALVES	INLET	LIST PRICE
AG8374C0053	20	300	(3) 1/2" HB	1/2" HB	\$521.11



Accessories

LONG RANGE ADJUSTABLE SPRAY GUNS

Long Range Spray Guns used for High Pressure Wash, Spraying Trees, and Fighting Fires. Easy to adjust spray pattern from straight to wide cone using front control handle. Diffuser creates small droplets for complete a plant coverage.



Turbine Spray Gun

New Turbine Spray Gun with 17" barrel features 10 mm internal stream straightener and adjustable spray pattern from zero degree to wide angle for complete coverage and long throw.

MODEL	MAX PSI	MAX GPM	STD. NOZZLE SIZE	INLET	LIST PRICE
AGSG-TURBINE	870 PSI	24 GPM	3.0 mm	1/2" HB w/Swivel	\$258.57
AGSG-TURBINE4.0	870 PSI	24 GPM	4.0 mm	1/2" HB w/Swivel	\$258.57
AGSG-TURBINE7.0	870 PSI	24 GPM	7.0 mm	1/2" HB w/Swivel	\$258.57
AGKIT-10/11	Repair Kit Turbine Gun				\$31.78



Long Range Turbine Gun

New Long Range High Performance Turbine Spray Gun with 21" barrel features 12 mm internal stream straightener and adjustable spray pattern from zero degree to wide angle for complete coverage of tall trees.

MODEL	MAX PSI	MAX GPM	STD. NOZZLE SIZE	INLET	LIST PRICE
AGSG-LR-TURBINE	870 PSI	30 GPM	4.0 mm	1/2" HB w/Swivel	\$352.78
AGKIT-10/11	Repair Kit Long Range Turbine Gun				\$31.78



Evolution Spray Gun

New Turbine Evolution Heavy Duty Long Range Spray Gun for spraying orchards, vineyards, greenhouses and trees. Easy to adjust spray pattern from straight to wide cone using front control handle. Diffuser creates small droplets for complete plant coverage.

MODEL	MAX PSI	MAX GPM	STD. NOZZLE SIZE	INLET	LIST PRICE
AGSG5500A	725 PSI	10 GPM	4.0 mm	1/2" HB w/Swivel	\$375.57
AGKIT7.901.10	Repair Kit Evolution Spray Gun				\$48.73



FOAM MIX Gun

New Foam Spray Guns for fire fighting and high volume pressure washing. Easy to adjust spray pattern from straight to cone using front control handle. Diffuser creates small droplets for creating foam mix. Innovative servo-assisted trigger for easy operation.

MODEL	MAX PSI	MAX GPM	STD. NOZZLE SIZE	INLET	LIST PRICE
AGSG-FOAM2	3600 PSI	13 GPM	4.5 mm	1/2" NPT(M) w/Swivel	\$708.34
AGKIT37.302.55	Repair Kit Foam Spray Gun				\$130.72

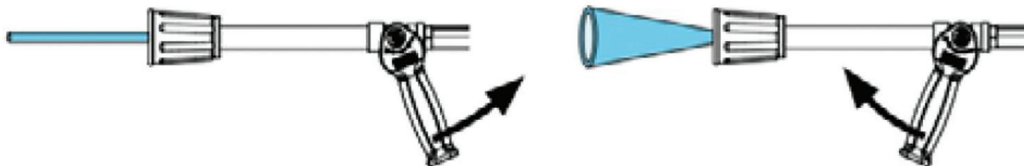



Accessories

PISTOL GRIP ADJUSTABLE SPRAY GUNS

Pistol grip spray guns feature ergonomic grip for one handed operation. Easy to adjust spray pattern from straight to wide cone using the thumb lever. Diffuser creates small droplets for complete spray coverage.



TURBO 400 Gun

MODEL	MAX PSI	MAX GPM	STD. NOZZLE SIZE	INLET	LIST PRICE
AGSG-TURBO	725 PSI	10 GPM	3.0 mm	1/2" HB w/Swivel	\$172.22
AGKIT26.901.4	Repair Kit Turbo 400 Spray Gun				\$89.88

*Additional nozzle sizes available.



NEW Max Ultra

New Ultra Spray Guns feature ergonomic grip for one handed operation. Used for spraying lawn, turf, ornamental bushes and trees. Easy to adjust spray pattern from straight to wide cone using the thumb lever. Diffuser creates small droplets for complete spray coverage.

MODEL	MAX PSI	MAX GPM	STD. NOZZLE SIZE	INLET	LIST PRICE
AGSG60000A	725 PSI	10 GPM	2.3 mm	1/2" HB w/Swivel	\$256.80
AGKIT46.901.46	Repair Kit Max Ultra Spray Gun				\$37.10



Heavy Duty Turbo 400

Turbo 400 Heavy Duty Metal Spray Guns feature ergonomic grip for one handed operation. Used for spraying lawn, turf, ornamental bushes and trees. Easy to adjust spray pattern from straight to wide cone. Diffuser can be adjusted to create small droplets for complete spray coverage.

MODEL	MAX PSI	MAX GPM	STD. NOZZLE SIZE	INLET	LIST PRICE
AGSG7000A	725 PSI	10 GPM	3.0 mm	1/2" HB w/Swivel	\$224.70
AGKIT26.302.6	Repair Kit				\$78.91

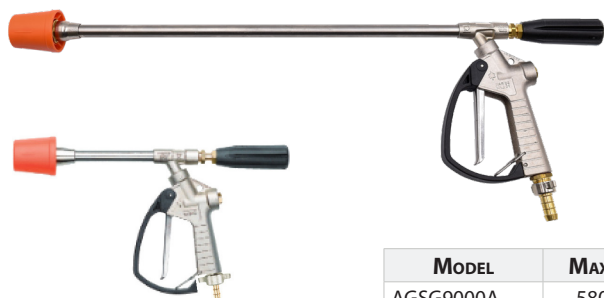

Greenhouse Spray Lance

New Nursery and Greenhouse Guns feature adjustable spray pattern that is set for consistent spray pattern. Easy to adjust spray pattern from straight to cone with the adjustment knob.

MODEL	MAX PSI	MAX GPM	STD. NOZZLE SIZE	INLET	LIST PRICE
AGSG9000A	580 PSI	1.8 GPM	1.5 mm Ceramic	12" Length 1/2" HB	\$162.29
AGSG9001A	580 PSI	1.8 GPM	1.5 mm Ceramic	24" Length 1/2" HB	\$174.67
AGKIT26.302.6	Repair Kit Spray Gun				\$78.91



SPRAYER ACCESSORIES

Adjustable spraying gun



- Adjustable spray pattern.
- Stop lever with instant drip sealing.
- Made of high resistance plastic materials.
- Equipped with standard ceramic spray tip.

MODEL	LENGTH	MAX PSI	MAX GPM	STD. NOZZLE SIZE	INLET	LIST PRICE
AG35.901.16	13"	580 PSI	8 GPM	2.3 mm	3/8" Hose Barb	\$140.47
AGKIT35.302.18	Repair Kit Ag Spray Guns					\$23.81

Adjustable spraying gun

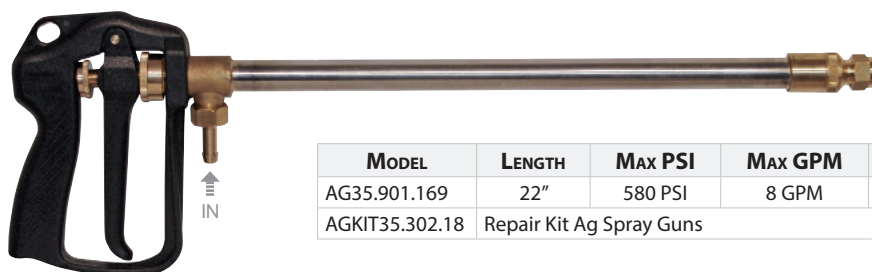

- Adjustable spray pattern.
- Stop lever with instant drip sealing.
- Made of high resistance plastic materials.
- Equipped with standard ceramic spray tip.

MODEL	LENGTH	MAX PSI	MAX GPM	STD. NOZZLE SIZE	INLET	LIST PRICE
AG35.901.169	22"	580 PSI	8 GPM	2.3 mm	3/8" Hose Barb	\$155.50
AGKIT35.302.18	Repair Kit Ag Spray Guns					\$23.81

ROOT FEEDERS

Root Feeders for injecting iron, liquid fertilizer and chemicals. Easy to use, accurate and lightweight stainless steel tubing frame and internal parts. Maximum pressure is 145 PSI. Model - EM includes flow meter for accurate metering



MODEL	DESCRIPTION	LIST PRICE
AG-ROOTFEEDER-EM	Root feeder with Flowmeter	\$835.22
AG-ROOTFEEDER	Root feeder	\$549.02
AG34.1803.26	Replacement Nozzle Tip	\$95.84
AG34.216.2	Replacement Flowmeter	\$351.18
AGKIT26.302.6	Repair Kit for Trigger Gun	\$78.91



Accessories

SPRAY GUN ACCESSORIES



MODEL	DESCRIPTION	LIST PRICE
AG162.604.3	Adapter: Straight 1/2" Hose Barb x 1/2" BSP	\$7.60



MODEL	DESCRIPTION	LIST PRICE
AGF163.604.6	Adapter: 90 Degree 1/2" Hose Barb x 1/2" BSP Flynut	\$16.65















MODEL	DESCRIPTION	LIST PRICE
AGF162.609.5	Adapter: 1/2" BSP x 1/2" BSP	\$9.33



MODEL	DESCRIPTION	LIST PRICE
AGF1002	Adapter: 1/2" BSPF x 1/2" NPTM	\$42.51
AG26.1502.45	Adapter: 1/2" BSPF x 1/2" BSPM	\$21.95

SPRAY GUN NOZZLES & PERFORMANCE CHART

			SPRAY PRESSURE												LIST PRICE
			200 PSI		350 PSI		500 PSI		580 PSI		650 PSI		725 PSI		
PART NUMBER	NOZZLE SIZE														
AGCN9015 Ceramic	1.5	GPM	1.1	1.3	1.5	1.7	1.8	2.0	1.9	2.2	2.0	2.3	2.1	2.4	\$21.13
		Max Throw ft	9	21	10	25	11	28	12	32	12	32	12	32	
AGCN9022 Ceramic	2.2	GPM	2.1	2.7	2.7	3.7	3.4	4.5	3.8	4.9	3.8	5.0	3.9	5.1	
		Max Throw ft	11	29	13	33	14	38	16	41	17	42	17	42	
AGCN9030 Ceramic	3.0	GPM	2.9	4.6	3.7	6.3	4.8	7.5	5.2	8.4	5.3	8.5	5.4	8.6	
		Max Throw ft	11	29	13	33	14	36	15	40	16	40	16	42	
AGCN9035 Ceramic	3.5	GPM	5.8	6.0	7.9	8.2	9.6	9.9	10.7	11.1	11.0	11.3	11.2	11.6	
		Max Throw ft	13	36	19	41	22	45	25	50	25	51	27	52	
AGN1802.40 Stainless Steel	4.0	GPM	7.0	7.3	9.6	9.9	11.6	12.0	12.9	13.5	13.8	13.6	14.1	15.0	
		Max Throw ft	15	37	20	42	24	47	27	53	27	54	28	55	
AGN1802.45 Stainless Steel	4.5	GPM	8.0	8.9	11.1	12.0	13.4	14.5	15.0	16.3	15.4	16.6	15.7	17.0	
		Max Throw ft	18	39	22	44	26	50	30	54	30	56	31	57	
AGN1802.50 Stainless Steel	5.0	GPM	9.8	10.2	13.3	13.8	16.0	16.7	18.0	18.7	18.4	19.1	18.9	19.5	
		Max Throw ft	20	40	23	47	27	53	32	59	32	61	33	62	
AGN1802.55 Stainless Steel	5.5	GPM	10.7	11.5	14.4	15.6	17.4	18.8	19.6	21.0	20.0	22.0	20.0	22.0	
		Max Throw ft	19	42	23	50	29	57	34	63	34	64	34	65	
AGN1802.60 Stainless Steel	6.0	GPM	11.5	12.6	15.6	17.1	18.8	20.6	21.0	23.2	21.5	23.7	22.0	24.2	
		Max Throw ft	21	43	25	54	30	60	35	66	35	67	36	68	
AGN1802.70 Stainless Steel	7.0	GPM	11.5	13.5	15.6	18.4	18.8	22.2	21.0	25.0	21.5	25.4	22.0	26.0	
		Max Throw ft	21	46	25	57	30	63	37	70	37	71	38	72	



ADJUSTABLE SPRAYING GUN



- Ergonomic nylon® handgrip, reinforced with fiberglass
- Balancing trigger
- Equipped with adjustable air mixing diffuser
- Perfect micro spraying of the liquid and low impact on the treated plants

MODEL	MAX PSI	MAX GPM	STD. NOZZLE SIZE	INLET	LIST PRICE
AGSG2000A	725 PSI	10 GPM	3.0 mm	1/2" HB w/Swivel	\$144.45

Additional Nozzle Sizes available

SPOT SPRAYING GUNS

- Durable, Light and Easy to Use:
- Excellent Chemical Resistance:
 - Polypropylene Handle
 - Pin and ball material: AISI 316
 - Seat Material: POM
- Built-in Storage Hook
- Trigger Lock system to keep the gun open.
- Inlet/Outlet filters standard

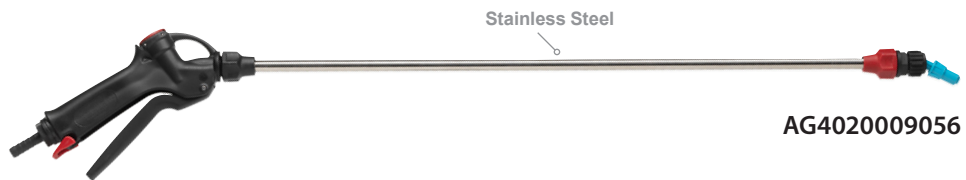

Strong Glass Filled Poly Construction

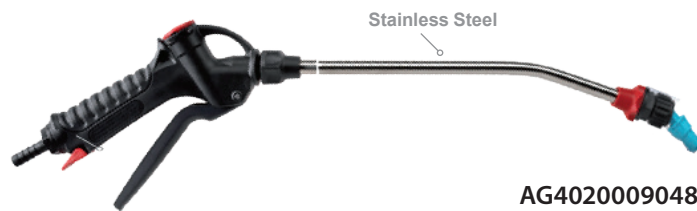

PART No.	PSI	GPM	INLET	LENGTH	WAND	O-RING	NOZZLE	LIST PRICE
AG4020009056	225	8	3/8"	30"	Bent	VITON®	Blue	\$53.40
AG4020009048				24"	Straight	VITON®	Blue	\$45.33



Accessories

NEW

AGRICULTURAL SPOT ATV SPRAY GUN



Agricultural Spot Sprayers Guns used with many ATV Sprayers. Available in Barrel lengths of 18", 24", and 30".

MODEL	LENGTH	MAX PSI	MAX GPM	STD. NOZZLE SIZE	INLET	LIST PRICE
AGSG9018A	18"	300 PSI	6 GPM	1.8 mm	3/8" NPTF	\$41.22
AGSG9024A	24"	300 PSI	6 GPM	1.8 mm	3/8" NPTF	\$45.07
AGSG9030A	30"	300 PSI	6 GPM	1.8 mm	3/8" NPTF	\$49.96



Drift Guard Shield for Spot Spray Guns used for precise spraying to protect vegetation from over spray. Works with Ag Spot Sprayer Guns above.

MODEL	DESCRIPTION	LIST PRICE
AGSS90088	Spray Shield for accurate & on target spraying	\$31.99

LOW PRESSURE 12V SPRAY GUNS

Low Pressure Spray Gun, Lightweight, with 3/8" Hose Barb connection, with Adjustable Nozzle from cone to straight stream.

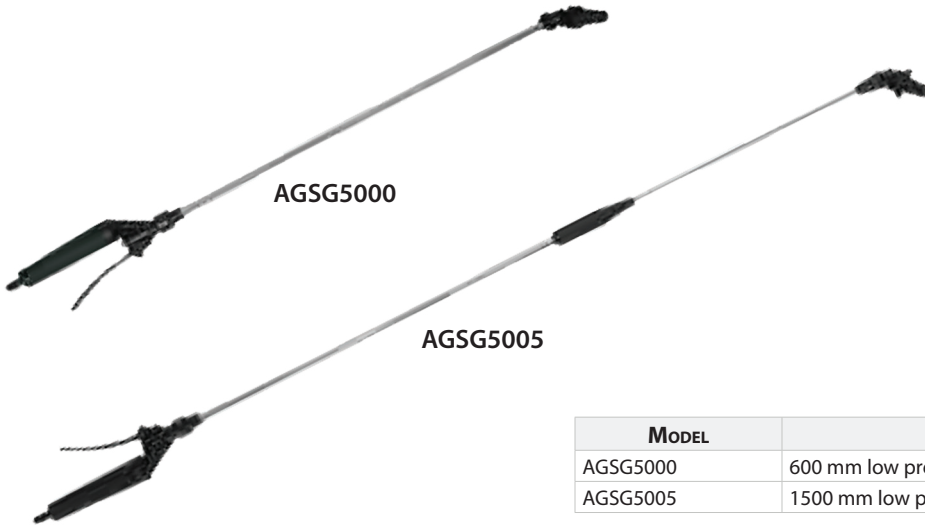

MODEL	DESCRIPTION	LIST PRICE
AGSG5000	600 mm low pressure gun	\$12.45
AGSG5005	1500 mm low pressure gun	\$16.63



MODEL	MAX PSI	MAX GPM	STD. NOZZLE SIZE	INLET	LIST PRICE
AGSG4000A	450 PSI	10 GPM	1.5 mm	3/8" HB	\$77.04



TANK LIDS, BASKET FILTERS AND ACCESSORIES

New Hinged Tank Lids

- Polypropylene construction
- Max opening angle: 180°
- Floating ball vent valve.



PART No.	ØC	BREATHER	LIST PRICE
AG8169014	12"	Floating Ball Vent Valve	\$49.10
AG8170015	16"	Floating Ball Vent Valve	\$56.50
AG8169015	12"	Closed	\$49.10
AG8170016	16"	Closed	\$56.50

Basket filters for tank lids

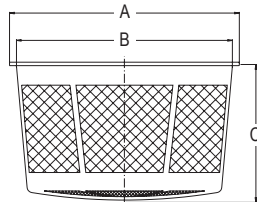

PART No.	DEPTH	SUITABLE FOR	LIST PRICE
AG8153000	2.4"	12" Tank Lids	\$13.38
AG8153001	9.5"		\$27.57
AG8159000	7.1"	16" Tank Lids	\$38.58
AG8159001	11.0"		\$41.56
AG8159002	12.6"		\$47.08

Gaskets for tank lid rings

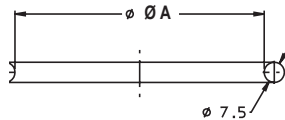

PART No.	TANK LIDS	A INCH	LIST PRICE
AGG00000006	12"	11.2"	\$7.67
AGG00000007	16"	14.6"	\$9.15

VENTED TANK LID FEATURE

LOCKING FEATURE

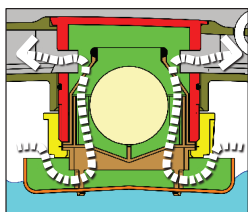

OPEN

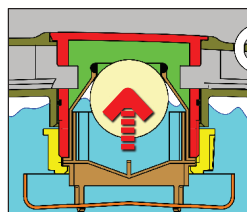

CLOSED



*Possibility to lock with padlock (not supplied).



TANK LIDS, BASKET FILTERS AND ACCESSORIES

Tank Lids, Vented



PART No.	SIZE	CONFIGURATION	LIST PRICE
AG8146002	8"	1 Labyrinth	\$20.37
AG8152004	12"	1 Labyrinth	\$23.54
AG8158005	16"	1 Labyrinth	\$27.57

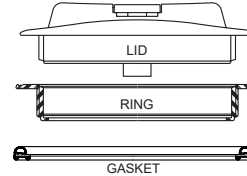

Ring, Basket, Filter & Gasket ordered separately.

Rings for vented tank lids



PART No.	SIZE	CONFIGURATION	LIST PRICE
AG8148000	8"	Flat Surface	\$8.07
AG8154000	12"		\$10.76
AG8160000	16"		\$13.45

Basket filters for tank lids

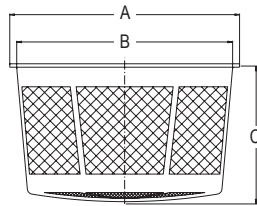

PART No.	SIZE	DEPTH	SUITABLE FOR RINGS	LIST PRICE
AG8147000	8"	1.9"	8148000	\$7.97
AG8147001	8"	4.7"		\$21.95
AG8147002	8"	9.4"		\$28.19
AG8153000	12"	2.4"	8154000	\$13.38
AG8153001	12"	9.4"		\$27.57
AG8159000	16"	7.1"	8160000	\$38.58
AG8159001	16"	11.0"		\$41.56
AG8159002	16"	12.6"		\$47.08

Gaskets for tank lid rings

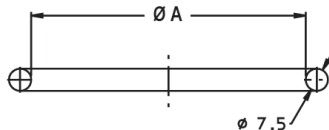

PART No.	TANK LIDS	A INCH	LIST PRICE
AGG00000011	8"	7.5"	\$6.59
AGG00000006	12"	11.2"	\$7.67
AGG00000007	16"	14.6"	\$9.15
AGG00000028	22"	19.9"	\$29.82



Accessories

NEW

TANK LIDS, BASKET FILTERS AND ACCESSORIES

Tank Lids, Closed



PART No.	SIZE	CONFIGURATION	LIST PRICE
AG8146000	8"	Closed	\$13.45
AG8152000	12"		\$22.19
AG8158000	16"		\$26.90
AG8164000	22"		\$64.56

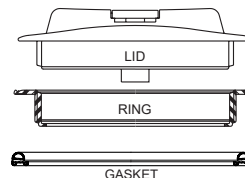

Ring, Basket, Filter & Gasket ordered separately.

Rings for closed tank lids



PART No.	SIZE	CONFIGURATION	LIST PRICE
AG8148000	8"	Flat Surface	\$8.07
AG8154000	12"		\$10.76
AG8160000	16"		\$13.45
AG8166000	22"		\$32.96

Basket filters for tank lids

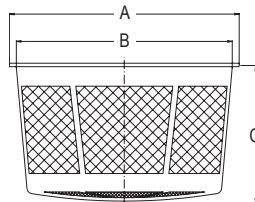

PART No.	SIZE	DEPTH	SUITABLE FOR RINGS	LIST PRICE
AG8147000	8"	1.9"	8148000	\$7.97
AG8147001	8"	4.7"		\$21.95
AG8147002	8"	9.4"		\$28.19
AG8153000	12"	2.4"	8154000	\$13.38
AG8153001	12"	9.4"		\$27.57
AG8159000	16"	7.1"	8160000	\$38.58
AG8159001	16"	11.0"		\$41.56
AG8159002	16"	12.6"		\$47.08

Gaskets for tank lid rings

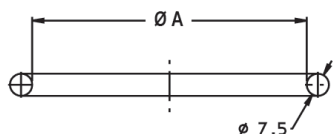

PART No.	TANK LIDS	A INCH	LIST PRICE
AGG00000011	8"	7.5"	\$6.59
AGG00000006	12"	11.2"	\$7.67
AGG00000007	16"	14.6"	\$9.15
AGG00000028	22"	19.9"	\$29.82



TANK ACCESSORIES

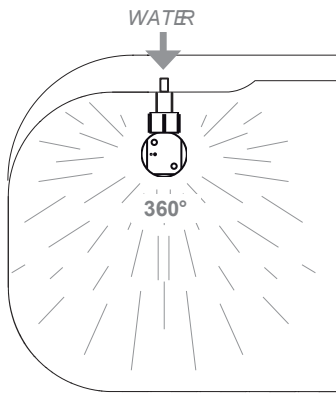
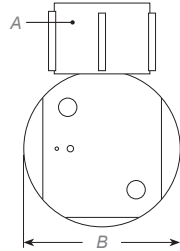

Rotating Spray Head

This tank rinsing nozzle is a fluid-driven rotating spray head which provides 360° coverage inside the surface of the tank.

PART No.	ANGLE	THREADS	LIST PRICE
AG8185007	360°	G1"	\$154.69



MOUNTING KIT		
PART No.	Ø	LIST PRICE
AGK00107002	1/2" HB	\$4.03

PERFORMANCE	
PRESSURE (PSI)	FLOW (GPM)
30	3.6
45	4.8
60	5.8

Tank rinsing head.

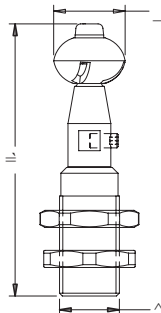
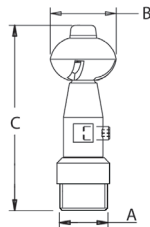

PART No.	ANGLE	A	B	C	PSI	LIST PRICE
AG8185005	240°	G 1/4M	1"	2.4"	150	\$57.14
AG8185003	360°	G 1/4M	1"	2.4"	150	

PART No.	ANGLE	A	B	C	PSI	LIST PRICE
AG8185000	240°	G 1/2M	1"	3.7"	150	\$93.50
AG8185006	360°	G 1/2M	1"	3.7"	150	

TYPE		FEATURES	
240°		PRESSURE (PSI)	FLOW (GPM)
		75	3.5
		100	4.0
		150	4.8

TYPE		FEATURES	
360°		PRESSURE (PSI)	FLOW (GPM)
		75	6.3
		100	7.7
		150	9.0



JET AGITATOR

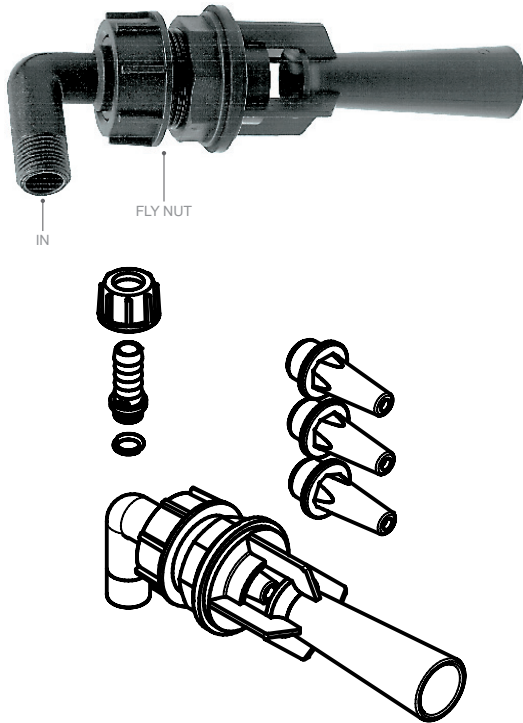

PART No.	NOZZLE SIZE	MATERIAL	IN	FLY NUT	LIST PRICE
AGK00112015	1.2	Ceramic	1/2" HB	1-1/4" G	\$35.19
	1.5				
	2				
	3				

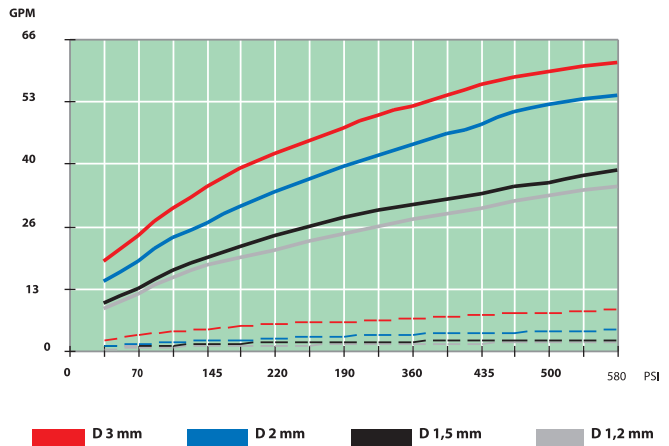

- **High Flow Jet Agitator:** For spray tanks keeps chemical from settling out
- **Unbroken line:** Total flow rate
- **Dashed line:** Nozzle flow rate
- Complete with all four nozzle sizes

Tank Breather Valve



Labyrinth breather valve.

PART No.	F	BREATHER	LIST PRICE
AG8208000	G1 M	Complete	\$7.77

Manual Adjustable Pressure Relief Valve

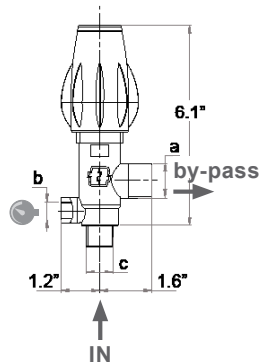

PART No.	GPM	PSI	By-PASS	GAUGE	INLET	LIST PRICE
AG8384050	20	60	3/4" NPT	1/4" NPT	1/2" NPT	\$38.80
AG8384052		60			3/4" NPT	
AG8384051		150			1/2" NPT	



SINGLE UNION BALL VALVES

2-Way Ball Valve - NPT



Fiberglass reinforced polypropylene body for strength and chemical resistance. Teflon seats for smooth operation and proper sealing characteristics. EPDM o-rings to handle most fertilizers and chemicals.

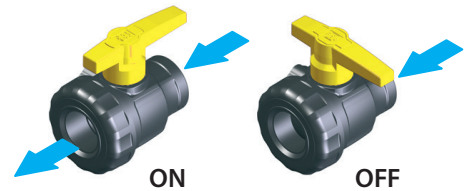

MODEL	SIZE F (NPT)	PORTS	MAX PSI	MOUNTING	LIST PRICE
AGBV8215127	3/8"	FF	232	none	\$20.85
AGBV8215178	1/2"	FF	232	none	
AGBV8215228	3/4"	FF	232	none	
AGBV8215278	1"	FF	232	8 mm	\$26.90
AGBV8215328	1 1/4"	FF	232	8 mm	\$34.98
AGBV8215378	1 1/2"	FF	145	8 mm	\$40.35
AGBV8215428	2"	FF	145	8 mm	\$53.81

Mounting Dimensions
1" & 1 1/4" Ball Valves

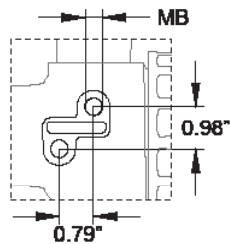

Mounting Dimensions
1 1/2" Ball Valves

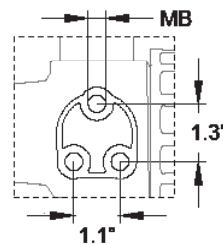

Mounting Dimensions
2" Ball Valves

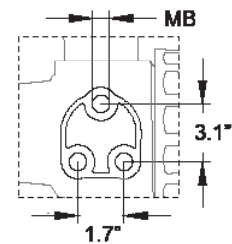

3-Way Ball Valve - NPT



Fiberglass reinforced polypropylene body for strength and chemical resistance. Teflon seats for smooth operation and proper sealing characteristics. EPDM o-rings to handle most fertilizers and chemicals.

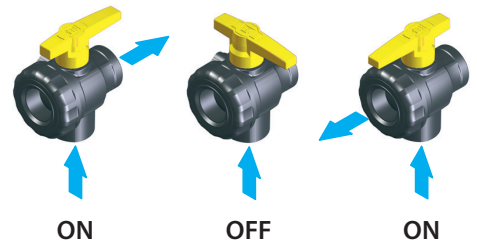

MODEL	SIZE F (NPT)	PORTS	MAX PSI	MOUNTING	LIST PRICE
AGBV8216180	1/2"	FFF	232	none	\$34.72
AGBV8216230	3/4"	FFF	232	none	\$33.45
AGBV8216276	1"	FFF	232	none	\$39.73
AGBV8216330	1 1/4"	FFF	232	8 mm	\$56.66
AGBV8216380	1 1/2"	FFF	145	8 mm	\$66.69
AGBV8216428	2"	FFF	145	8 mm	\$83.31

Mounting Dimensions
1" & 1 1/4" Ball Valves

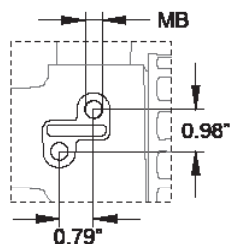

Mounting Dimensions
1 1/2" Ball Valves

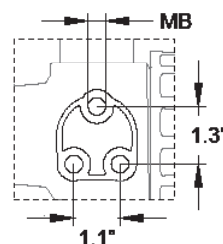

Mounting Dimensions
2" Ball Valves

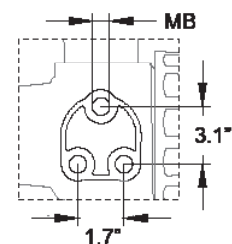



LINE STRAINERS

300 psi

1/2 NPT F
3/4 NPT F



PART No.	F	GPM	MESH	SCREEN MATERIAL	EFFECTIVE AREA	LIST PRICE
AG8105092	1/2 NPT F	20	16	Stainless Steel	4.1	\$25.22
AG8105012			32		4	
AG8105013			50		3.7	
AG8105093	3/4 NPT F	26	16	Stainless Steel	4.1	\$25.22
AG8105016			32		4	
AG8105017			50		3.7	
AG8105018			80		3.4	
AG8105019			100		3.6	
AG8105094	1 NPT F	40	16	Stainless Steel	6.0	\$29.86
AG8105020			32		5.9	
AG8105021			50		5.4	
AG8105022			80		5.3	
AG8105023			100		5.1	

300 psi

1 NPT F



DIMENSIONS 1/2" & 3/4"

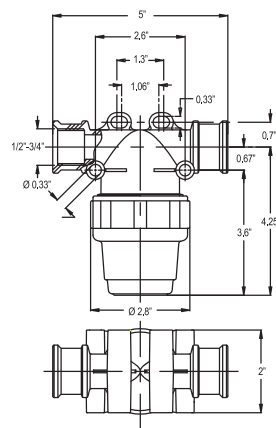

DIMENSIONS 1"

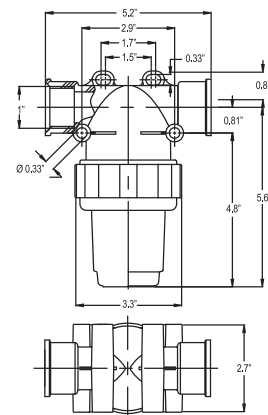

SPARE PARTS - 1/2" 3/4"

PART No.	SCREEN MESH	SCREEN MATERIAL	LIST PRICE
AGC00100000	32		
AGC00100001	50		
AGC00100002	80		
AGC00100003	100		

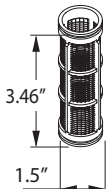

SPARE PARTS - 1"

PART No.	SCREEN MESH	SCREEN MATERIAL	LIST PRICE
AGC00100004	32		
AGC00100005	50		
AGC00100006	80		
AGC00100007	100		

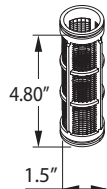

STRAINER ELEMENT GASKET

PART No.	GASKET	MATERIAL	LIST PRICE
AGG00001024	O-Ring	EPDM	\$1.00



STRAINER ELEMENT GASKET

PART No.	GASKET	MATERIAL	LIST PRICE
AGG00001024	O-Ring	EPDM	\$1.00



STRAINER ELEMENT GASKET

PART No.	GASKET	MATERIAL	LIST PRICE
AGG00001064	O-Ring	EPDM	\$1.48



STRAINER ELEMENT GASKET

PART No.	GASKET	MATERIAL	LIST PRICE
AGG00001050	O-Ring	EPDM	\$0.94





DRY BOOM NOZZLE BODIES

300 psi

Nozzle bodies with diaphragm check-valve in VITON®, including o-ring gasket, screw and nut. Quick fittings (caps not included).

3 Way Nozzle Body



PART No.	TYPE	D	LIST PRICE
AG8245018	Single HB	1/2"	\$21.73
AG8245030		3/4"	
AG8245066		1"	
AG8245090	Double HB	1/2"	\$21.73
AG8245102		3/4"	
AG8245138		1"	

5 Way Nozzle Body



PART No.	TYPE	D	LIST PRICE
AG8245023	Single HB	1/2"	\$27.94
AG8245035		3/4"	
AG8245071		1"	
AG8245095	Double HB	1/2"	\$27.94
AG8245107		3/4"	
AG8245143		1"	

CLAMPS



PART No.	Ø	LIST PRICE
AG8235036	3/4"	\$5.09
AG8235038	1"	\$5.09
AG8235040	1-1/4"	\$5.09

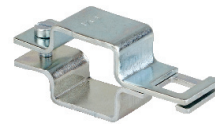

PART No.	Ø	LIST PRICE
AG8235037	3/4"	\$5.09
AG8235039	1"	\$5.09
AG8235041	1-1/4"	\$5.09
AG8235043	1-1/2"	\$5.09



WET BOOM NOZZLE BODIES

Nozzle bodies with diaphragm check-valve VITON®, including o-ring gasket, fixing screw and nut. Quick fittings (caps not included).

300 psi

Wet Boom 3 Way Nozzle Body
10 per bag



PART No.	TYPE	F IN	D	LIST PRICE
AG8244226	RH	3/8"	20mm	\$19.77
AG8244238			22mm	
AG8244250			25mm	
AG8244292			1/2"	
AG8244316			3/4"	
AG8244346			1"	
AG8244227	LH	3/8"	20mm	\$19.77
AG8244239			22mm	
AG8244251			25mm	
AG8244293			1/2"	
AG8244317			3/4"	
AG8244347			1"	

*Order in quantity of 10

Wet Boom 5 Way Nozzle Body
10 per bag



PART No.	TYPE	FMM	D	LIST PRICE
AG8244230	RH	3/8"	20mm	\$23.47
AG8244242			22mm	
AG8244254			25mm	
AG8244296			1/2"	
AG8244320			3/4"	
AG8244350	1"			
AG8244231	LH	3/8"	20mm	\$23.47
AG8244243			22mm	
AG8244255			25mm	
AG8244297			1/2"	
AG8244321			3/4"	
AG8244351	1"			

*Order in quantity of 10

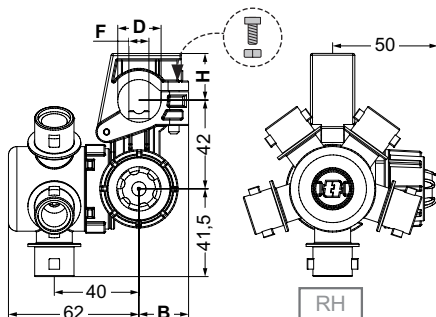

Type:

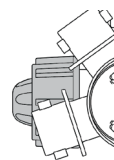

Version with left hand check-valve.

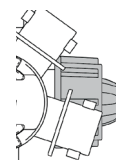

Version with right hand check-valve.



Accessories

NEW

NOZZLE BODIES

Triple nozzle bodies with diaphragm check-valve VITON® and o-ring gasket. Quick fittings (caps not included).

225 psi

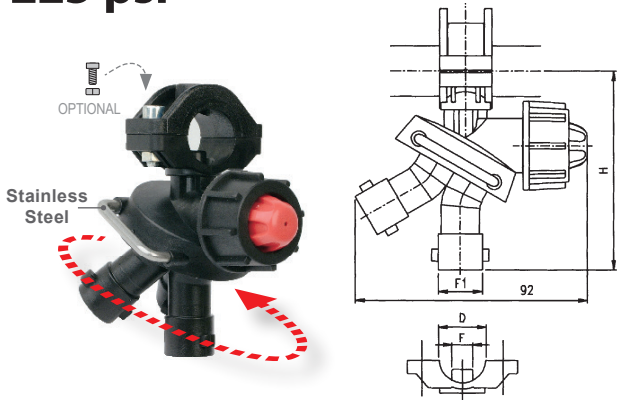

PART No.	F1	F	D	BMM	LIST PRICE
AG8239013	QUICK	3/8"	1/2"	82	\$27.22
AG8239015			3/4"	87	
AG8239023			1"	87	

SPARE PARTS			
	PART No.	DIAPHRAGM MATERIAL	LIST PRICE
	AGM00100000	EPDM	\$1.07
	AGM00100001	VITON®	\$2.64

	PART No.	FMM	LIST PRICE
	AGG00001008	10	\$0.35

OPTIONALS			
	PART No.	LIST PRICE	
	AGK00001000	\$0.92	
Screw Kit			

Triple nozzle bodies with diaphragm check-valve VITON®. Quick fittings (caps not included).

225 psi

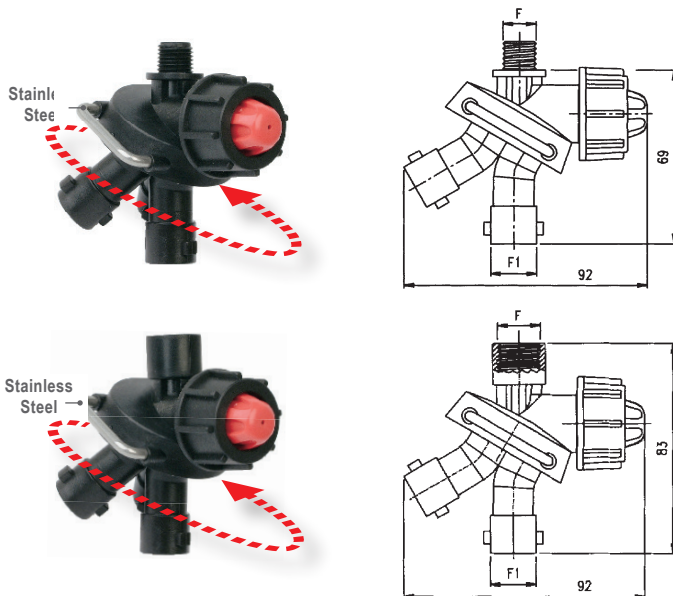

PART No.	F1	F	LIST PRICE
AG8239017	Quick	1/4" NPT M	\$25.50
AG8239019		G 3/8" F	

SPARE PARTS			
	PART No.	DIAPHRAGM MATERIAL	LIST PRICE
	AGM00100000	EPDM	\$1.07
	AGM00100001	VITON®	\$2.64

OPTIONALS	



NOZZLE BODIES WITH DIAPHRAGM CHECK-VALVE

300 psi

Nozzle bodies with diaphragm check-valve in VITON® with shutoff, including o-ring gasket, fixing screw and nut. The check-valve with shutoff allows each individual nozzle body to be closed by turning the red nut located on the check valve. Caps not included.



PART No.	GASKET MATERIAL	F1	F	D	LIST PRICE
AG8234089	VITON®	Quick	3/8"	20mm	\$12.01
AG8234091				1/2"	
AG8234092				3/4"	
AG8234093				1"	

300 psi



PART No.	GASKET MATERIAL	F1	FIN	LIST PRICE
AG8234098	VITON®	G 3/8" M	G 1/4" F	\$12.24
AG8234099			G 1/4" M	
AG8234100			G 3/8" F	
AG8234101			11/16" F	

300 psi



PART No.	GASKET MATERIAL	F1	FIN	LIST PRICE
AG8234109	VITON®	Quick	3/8"	\$11.77
AG8234111				
AG8234112				
AG8234113				



Accessories

NEW

NOZZLE BODIES WITH DIAPHRAGM CHECK-VALVE

Nozzle bodies with diaphragm check-valve sealing o-ring and red colored threaded cap.

300 psi

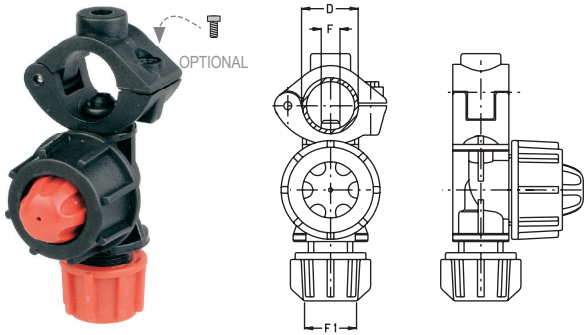

PART No.	GASKET MATERIAL	F1	F	D	LIST PRICE
AG8234002	EPDM	G 3/8" M	3/8"	20mm	\$7.22
AG8234006				1/2"	
AG8234047				25mm	\$8.35
AG8234008				3/4"	
AG8234050				1"	

SPARE PARTS			
	PART No.	DIAPHRAGM MATERIAL	LIST PRICE
	AGM00100000	EPDM	\$1.07
	AGM00100001	VITON®	\$2.64

	PART No.	F	LIST PRICE
	AGG00001008	3/8"	\$0.35

OPTIONALS					
			PART No.	TYPE	LIST PRICE
			AGV00007005		\$0.70
			AGV00007000		

Nozzle bodies with diaphragm check-valve and o-ring seal. Quick fitting (cap not included)

300 psi

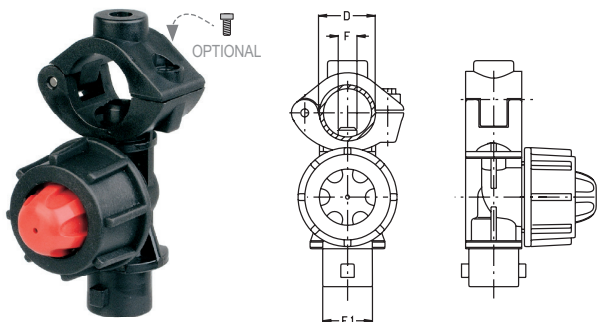

PART No.	GASKET MATERIAL	F1	F	D	LIST PRICE
AG8234003	EPDM	Quick	3/8"	20mm	\$6.91
AG8234007				1/2"	
AG8234026				25mm	\$8.08
AG8234009				3/4"	
AG8234051				1"	

SPARE PARTS			
	PART No.	DIAPHRAGM MATERIAL	LIST PRICE
	AGM00100000	EPDM	\$1.07
	AGM00100001	VITON®	\$2.64

	PART No.	F	LIST PRICE
	AGG00001008	3/8"	\$0.35

OPTIONALS					
			PART No.	TYPE	LIST PRICE
			AGV00007005		\$0.70
			AGV00007000		



NOZZLE BODIES



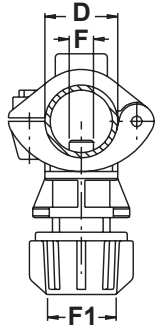

Nozzle bodies with o-ring seal and red colored threaded cap.

300 psi



PART No.	F1	F	D	LIST PRICE
AG8230002	G 3/8" M	3/8"	20mm	\$3.00
AG8230006			1/2"	
AG8230008			3/4"	\$3.99
AG8230010			1"	

SPARE PARTS			
	PART No.	F	LIST PRICE
	AGG00001008	3/8"	\$0.35

OPTIONALS					
			PART No.	TYPE	LIST PRICE
			AGV00007005		\$0.70
			AGV00007000		



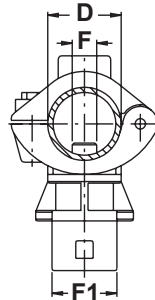

Nozzle bodies with o-ring seal.
Quick fittings (caps not included).

300 psi



PART No.	F1	F	D	LIST PRICE
AG8230003	Quick	3/8"	20mm	\$2.64
AG8230007			1/2"	
AG8230009			3/4"	\$3.54
AG8230011			1"	\$3.54

SPARE PARTS			
	PART No.	FMM	LIST PRICE
	AGG00001008	3/8"	\$0.35

OPTIONALS					
			PART No.	TYPE	LIST PRICE
			AGV00007005		\$0.70
			AGV00007000		



NOZZLE BODIES

Nozzle bodies for dry booms.
Quick fittings (caps not included).

300 psi



PART No.	Ø	LIST PRICE
AG8231001	3/8"	\$3.48
AG8231003	1/2"	
AG8231005	3/4"	

PART No.	Ø	LIST PRICE
AG8231007	3/8"	\$3.48
AG8231009	1/2"	
AG8231011	3/4"	

PART No.	Ø	LIST PRICE
AG8231013	3/8"	\$3.48
AG8231015	1/2"	
AG8231017	3/4"	

Nozzle bodies for dry booms, with diaphragm check-valve (EPDM).
Quick fittings (caps not included).

300 psi



PART No.	Ø	LIST PRICE
AG8235001	3/8"	\$9.59
AG8235003	1/2"	
AG8235005	3/4"	

PART No.	Ø	LIST PRICE
AG8235007	3/8"	\$8.59
AG8235009	1/2"	
AG8235011	3/4"	

PART No.	Ø	LIST PRICE
AG8235013	3/8"	\$9.59
AG8235015	1/2"	
AG8235017	3/4"	



PART No.	Ø	LIST PRICE
AG8235019	3/8"	\$8.07
AG8235021	1/2"	
AG8235023	3/4"	

PART No.	Ø	LIST PRICE
AG8235025	3/8"	\$8.07
AG8235027	1/2"	
AG8235029	3/4"	



Accessories

NEW

NOZZLE BODIES

Nozzle bodies for dry booms.
Complete with red colored threaded cap.

300 psi



PART No.	Ø	LIST PRICE
AG8231000	3/8"	\$4.01
AG8231002	1/2"	
AG8231004	3/4"	

PART No.	Ø	LIST PRICE
AG8231006	3/8"	\$4.01
AG8231008	1/2"	
AG8231010	3/4"	

PART No.	Ø	LIST PRICE
AG8231012	3/8"	\$4.01
AG8231014	1/2"	
AG8231016	3/4"	

Dry Boom Adapter:



OPTIONALS



Nozzle bodies for dry booms.
Quick fittings (caps not included).

300 psi



PART No.	Ø	LIST PRICE
AG8231001	3/8"	\$3.48
AG8231003	1/2"	
AG8231005	3/4"	

PART No.	Ø	LIST PRICE
AG8231007	3/8"	\$3.48
AG8231009	1/2"	
AG8231011	3/4"	

PART No.	Ø	LIST PRICE
AG8231013	3/8"	\$3.48
AG8231015	1/2"	
AG8231017	3/4"	

Dry Boom Adapter:



OPTIONALS





Accessories

NEW

NOZZLE BODIES

Nozzle bodies for dry booms, with diaphragm check-valve (EPDM).
Quick fittings (caps not included).

300 psi



PART No.	Ø	LIST PRICE
AG8235001	3/8"	\$9.59
AG8235003	1/2"	
AG8235005	3/4"	



PART No.	Ø	LIST PRICE
AG8235007	3/8"	\$9.59
AG8235009	1/2"	
AG8235011	3/4"	



PART No.	Ø	LIST PRICE
AG8235013	3/8"	\$9.59
AG8235015	1/2"	
AG8235017	3/4"	



PART No.	Ø	LIST PRICE
AG8235019	3/8"	\$8.07
AG8235021	1/2"	
AG8235023	3/4"	



PART No.	Ø	LIST PRICE
AG8235025	3/8"	\$8.07
AG8235027	1/2"	
AG8235029	3/4"	

Dry Boom Adapter:



SPARE PARTS

	PART No.	DIAPHRAGM MATERIAL	LIST PRICE
	AGM00100000	EPDM	\$1.07
	AGM00100001	VITON®	\$2.64

OPTIONALS





Accessories

NEW

NOZZLE BODIES

Adjustable triple nozzle bodies with diaphragm (EPDM) check-valve for dry booms. Quick fittings (caps not included).

225 psi



PART No.	Ø	LIST PRICE
AG8240001	1/2"	\$26.12
AG8240003	3/4"	

PART No.	Ø	LIST PRICE
AG8240005	1/2"	\$26.12
AG8240007	3/4"	

PART No.	Ø	LIST PRICE
AG8240009	1/2"	\$26.12
AG8240011	3/4"	

Dry Boom Adapter:



SPARE PARTS			
	PART No.	DIAPHRAGM MATERIAL	LIST PRICE
	AGM00100000	EPDM	\$1.07
	AGM00100001	VITON®	\$2.64

OPTIONALS		
		

Nozzle bodies with diaphragm (EPDM) check-valve for dry booms 1/2". Quick fittings (caps not included).

300 psi



Single Left



Double



Single Right

PART No.	Ø	LIST PRICE
AG8235035	1/2"	\$9.87

PART No.	Ø	LIST PRICE
AG8235033	1/2"	\$11.74

PART No.	Ø	LIST PRICE
AG8235031	1/2"	\$9.46

SPARE PARTS			
	PART No.	DIAPHRAGM MATERIAL	LIST PRICE
	AGM00100000	EPDM	\$1.07
	AGM00100001	VITON®	\$2.64

OPTIONALS		
		



Accessories

NEW

NOZZLE BODIES

Dry Boom hosebarb with threaded fitting 1/4" NPT.

300 psi



PART No.	Ø MM	LIST PRICE
AG8231018	10 (3/8")	\$3.81
AG8231020	13 (1/2")	
AG8231022	19 (3/4")	

PART No.	Ø MM	LIST PRICE
AG8231024	10 (3/8")	\$3.81
AG8231026	13 (1/2")	
AG8231028	19 (3/4")	

PART No.	Ø MM	LIST PRICE
AG8231030	10 (3/8")	\$3.81
AG8231032	13 (1/2")	
AG8231034	19 (3/4")	

Dry Boom Adapter:



CLAMPS

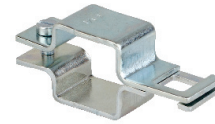

PART No.	Ø	LIST PRICE
AG8235036	3/4"	\$5.09
AG8235038	1"	
AG8235040	1-1/4"	

PART No.	Ø	LIST PRICE
AG8235037	3/4"	\$5.09
AG8235039	1"	
AG8235041	1-1/4"	
AG8235043	1-1/2"	



Accessories

NEW

NOZZLE BODY ADAPTERS

45° Quick coupling



PART No.	F	LIST PRICE
AG8230018	Quick	\$5.24

90° Quick coupling for cap



PART No.	F	LIST PRICE
AG8230022	Quick	\$3.60

NOZZLE BODY ACCESSORIES

Hose drops

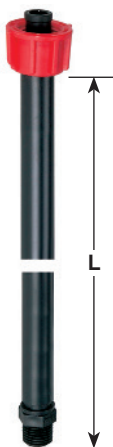

PART No.	L	TYPE	LIST PRICE
AG8251000	15"	Quick	\$10.24
AG8251001	15"	3/8" G	\$10.24
AG8251002	24"	Quick	\$11.12
AG8251003	24"	3/8" G	\$11.12

45° Quick coupling



PART No.	F	LIST PRICE
AG8230018	Quick	\$5.24

90° Quick coupling for cap



PART No.	F	LIST PRICE
AG8230022	Quick	\$3.60

Threaded spraying boom terminal - quick coupling elbow (45°)



PART No.	F	LIST PRICE
AG8230016	G 1/2"	\$3.32
AG8230014	G 3/4"	\$3.15



Accessories

NEW

NOZZLE BODY ACCESSORIES

Quick fitting adapters



PART No.	F	LIST PRICE
AG8230015	G 1/4" BSP	\$1.82
AG8230017	1/4" NPT	



PART No.	F	LIST PRICE
AG8230019	G 1/4" BSP	\$2.55
AG8230021	1/4" NPT	

Boom flushing quick - fitting adapter

PART No.	LIST PRICE
AG8253040	\$1.61

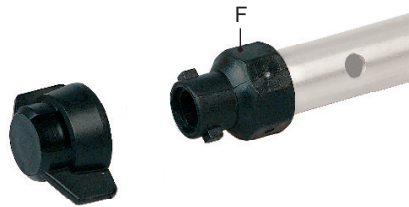

PART No.	F	LIST PRICE
AG8294020	G 3/8" BSP	\$2.60
AG8294021	G 1/2" BSP	
AG8294022	G 3/4" BSP	\$4.07

Hose fitting for dry boom* - nozzle bodies

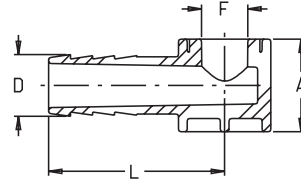

PART No.	A	D IN	F IN	L IN	LIST PRICE
AG8294014	1/2"	1/2"	3/8"	1.6"	\$1.55
AG8294015	3/4"	3/4"			
AG8294016	3/4"	1"			
AG8294028	1"	3/4"			
AG8294029	1"	1"			

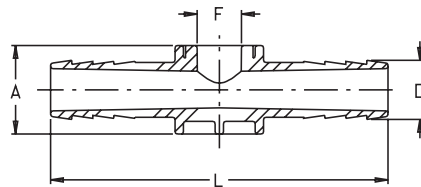

PART No.	A	D IN	F IN	L IN	LIST PRICE
AG8294017	1/2"	1/2"	3/8"	3.2"	\$1.63
AG8294018	3/4"	3/4"			
AG8294019	3/4"	1"			
AG8294030	1"	3/4"			
AG8294031	1"	1"			



Accessories

NEW

NOZZLES AND NOZZLE HOLDERS

Kit for Head with Universal Quick-release Coupling

- Used to fit all types of nozzle with Ø8 and Ø10 mm.
- Complete with gasket.

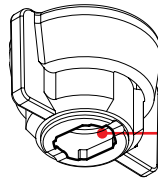
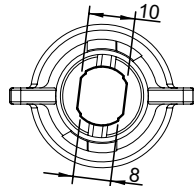

Nozzle seat with double centring

PART No.	COLOR	FOR NOZZLES	8MM	10MM	HOLLOW CONE	FLOOD NOZZLES	LIST PRICE
AG8253085	grey	Lechler®, AlbuZ®, TeeJet®, Geoline®, Lurmark®, Tecnomat®, Arag®, John Deere®, Hypro®, Vicon®, Douven®, Dubex®, CHD Eefting®, Rau® (from 2000), Inuma®, Dammann®, Jacoby®	IDK, IDKN, IDKT, IDKS, AD, LU, ST, ES, OC, ADI, API, APS, ADX	ID, IDN, IS, DF, FL	TR, ITR TK FloodJet® TXA ConeJet® FL FullJet® TG Fullcone®	FT AI TeeJet® TKFloodjet® VS Floodjet®	\$1.61
AG8253084	violet						
AG8253083	brown						
AG8253082	orange						
AG8253081	white						
AG8253080	black						
AG8253079	blue						
AG8253078	green						
AG8253077	yellow						
AG8253076	red						
AG8253131	lilac						

FILTERS

Nozzle filters

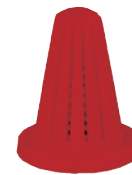
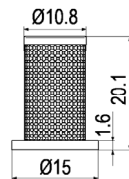

PART No.	SCREEN MESH	LIST PRICE
AG8139017-PK10	30 Mesh	\$16.23
AG8139018-PK10	50 Mesh	
AG8139019-PK10	80 Mesh	
AG8139020-PK10	100 Mesh	
AG8139021-PK10	120 Mesh	

PART No.	SCREEN MESH	LIST PRICE
AG8139022-PK50	25 Mesh	\$107.39
AG8139023-PK50	50 Mesh	
AG8139024-PK50	80 Mesh	



NOZZLE BODIES

217 psi

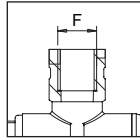

Swivel female nozzle body - quick-fitting

PART No.	F	LIST PRICE
AG8247012	NPT 1/4" F	\$8.44

217 psi

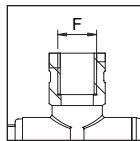

Swivel female nozzle body - BSP 3/8" fly nut

PART No.	F	LIST PRICE
AG8247018	NPT 1/4" F	\$8.44

217 psi

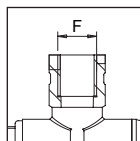

Double swivel female nozzle body - quick-fitting

PART No.	F	LIST PRICE
AG8247015	NPT 1/4" F	\$10.29

217 psi

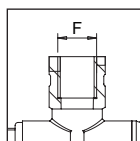

Double swivel female nozzle body - BSP 3/8" fly nut

PART No.	F	LIST PRICE
AG8247021	NPT 1/4" F	\$10.29



DOUBLE NOZZLE BODIES NPT

735 psi

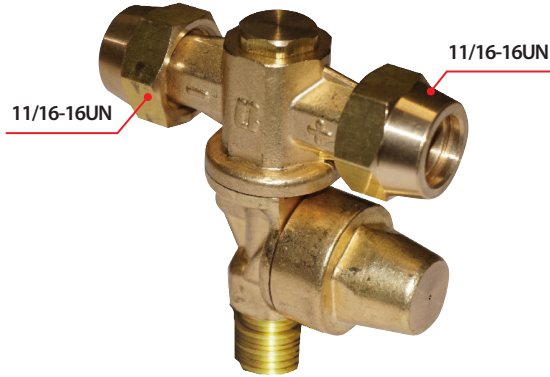

Double nozzle body with diaphragm check valve and hex nuts

PART No.	DISC	F	LIST PRICE
AG8268036	2 x Ø 15	1/4" NPT M	\$29.60

735 psi

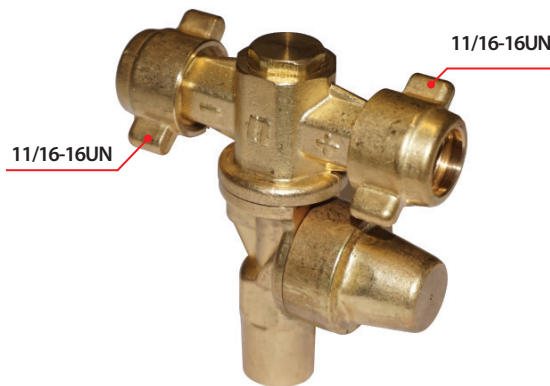

Double nozzle body with diaphragm check valve and fly nuts

PART No.	DISC	F	LIST PRICE
AG8268034	2 x Ø 15	1/4" NPT F	\$29.60



Accessories

DOUBLE NOZZLE BODIES

Brass rollover Nozzle with and without anti-drip diaphragm check valve for use on air blast sprayers. Available with one or two selectable nozzles with locking positions.

580 psi

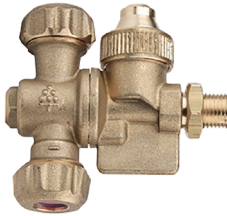

Double Nozzle Complete with Anti-Drip Valve

MODEL	DESCRIPTION	LIST PRICE
AGVM0118.14M	Double Nozzle 1/4" BSPM Threads	\$39.27
AGVM0118.14F	Double Nozzle with 1/4" BSPF Threads	\$39.27
AGVM-119.38M	Double Nozzle with 3/8" BSPM Threads	\$39.27

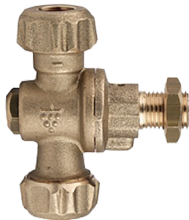

Double Nozzle Complete without Anti-Drip Valve

MODEL	DESCRIPTION	LIST PRICE
AGVM0418.14M	Double Nozzle 1/4" BSPM Threads	\$34.96
AGVM0418.14F	Double Nozzle with 1/4" BSPF Threads	\$34.96
AGVM0418.38M	Double Nozzle with 3/8" BSPM Threads	\$34.96

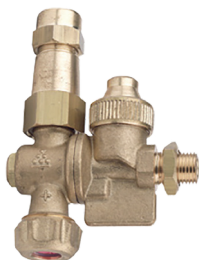

Adjustable Double Nozzle Complete with Anti-Drip Valve

MODEL	DESCRIPTION	LIST PRICE
AGVM1815.14M	Double Nozzle 1/4" BSPM Threads	\$48.59
AGVM1815.14F	Double Nozzle with 1/4" BSPF Threads	\$48.59
AGVM1815.38M	Double Nozzle with 3/8" BSPM Threads	\$48.59



Adjustable Double Nozzle Complete without Anti-Drip Valve

MODEL	DESCRIPTION	LIST PRICE
AGVM6815.14M	Double Nozzle 1/4" BSPM Threads	\$42.69
AGVM6815.14F	Double Nozzle with 1/4" BSPF Threads	\$42.69
AGVM6815.38M	Double Nozzle with 3/8" BSPM Threads	\$42.69



Accessories

SINGLE NOZZLE BODIES

Brass rollover Nozzle with and without anti-drip diaphragm check valve for use on air blast sprayers. Available with one or two selectable nozzles with locking positions. 580 MAX PSI.

580 psi



Single Nozzle Complete with Anti-Drip Valve Ø 30

MODEL	DESCRIPTION	LIST PRICE
AGVM0230.14M	Single Nozzle 1/4" BSPM Threads	\$41.53
AGVM0230.14F	Single Nozzle with 1/4" BSPF Threads	\$41.53
AGVM0230.38M	Single Nozzle with 3/8" BSPM Threads	\$41.53



Single Nozzle Complete without Anti-Drip Valve Ø 30

MODEL	DESCRIPTION	LIST PRICE
AGVM0530.14M	Single Nozzle 1/4" BSPM Threads	\$35.80
AGVM0530.14F	Single Nozzle with 1/4" BSPF Threads	\$35.80
AGVM0530.38F	Single Nozzle with 3/8" BSPM Threads	\$35.80

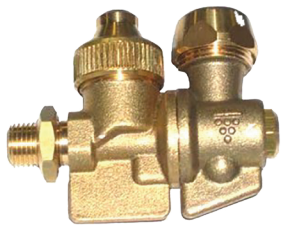

Single Nozzle Complete with Anti-Drip Valve Ø 18

MODEL	DESCRIPTION	LIST PRICE
AGVM1318.14M	Single Nozzle 1/4" BSPM Threads	\$34.43
AGVM1318.14F	Single Nozzle with 1/4" BSPF Threads	\$34.43
AGVM1318.38M	Single Nozzle with 3/8" BSPM Threads	\$34.43



Single Nozzle Complete without Anti-Drip Valve Ø 18

MODEL	DESCRIPTION	LIST PRICE
AGVM1418.14M	Single Nozzle 1/4" BSPM Threads	\$28.92
AGVM1418.14F	Single Nozzle with 1/4" BSPF Threads	\$28.92
AGVM1418.38M	Single Nozzle with 3/8" BSPM Threads	\$28.92



Accessories

SPRAY NOZZLES

Nozzle complete of 1.5mm cone spray tip with a maximum operating pressure of 725 PSI. For use on air blast sprayers for vineyards and orchards. The spherical adjustable joint allows the nozzle positioning.

725 psi



Curved Atomizing Sprayer Nozzle, 90 degree elbow with Adjustable Spherical Joint

MODEL	DESCRIPTION	LIST PRICE
AGVM1014	Atomizing Spray Nozzle with 1/4" BSPM Threads	\$49.57
AGVM1038	Atomizing Spray Nozzle with 3/8" BSPM Threads	\$51.65



Straight Atomizing Sprayer Nozzle with Adjustable Spherical Joint

MODEL	DESCRIPTION	LIST PRICE
AGVM2014	Atomizing Spray Nozzle with 1/4" BSPM Threads	\$42.69
AGVM2038	Atomizing Spray Nozzle with 3/8" BSPM Threads	\$48.89

BUTTERFLY NOZZLES

Nozzle complete with Ø 15 ceramic spray tip. 1.2 mm orifice, and a maximum operating pressure of 725 PSI. For use on air blast sprayers for vineyards and orchards. The spray tip can be easily inspected and replaced. The spherical joint allows the nozzle positioning.

725 psi



AGVM010C.14M



AGVM011T.14M

MODEL	DESCRIPTION	LIST PRICE
AGVM010C.14M	Butterfly Nozzle with 1.2 mm Orifice	\$33.05
AGVM011T.14M	Butterfly Nozzle with Turbo and Anti-Drip 1.2 mm Orifice	\$60.73

Butterfly Nozzle with 1.2 mm orifice and complete with Turbo nozzle protector, rated at 725 PSI

For use with air blast sprayers for spraying vineyards and orchards. The Turbo nozzle protector allows exceptional atomization of the spray product and excellent coverage.



AGVM009T.14M

MODEL	DESCRIPTION	LIST PRICE
AGVM009T.14M	Butterfly Nozzle with 1.2 mm Orifice	\$36.44



Accessories

ORCHARD SPRAYER NOZZLES

580 psi

Nozzle complete with 80° cone nozzle

Maximum operating pressure of 580 PSI, for use on air blast sprayers. Inlet port 1/4" BSP-F.



Ø 18



Ø 30

MODEL	DESCRIPTION	LIST PRICE
AGVM00718.14F	Orchard Sprayer Nozzle Ø 18	\$28.92
AGVM0830.14F	Orchard Sprayer Nozzle Ø 30	\$36.50

LINE BRASS FILTERS

725 psi

In Line Brass Filter with drain tap, for flow rate 0-18 GPM

Maximum pressure 725 PSI. Port Size 1/2" BSP-F.



MODEL	DESCRIPTION	LIST PRICE
AGVMF002.12	Brass filter with swivel nut	\$79.23
AGVMF002.1212	Brass filter with straight threads	\$82.63
AGVMF10040	40 mesh filter element	\$17.22
AGVMF10070	70 mesh filter element	\$22.73
AGVMF10100	100 mesh filter element	\$23.41

580 psi

In Line Brass Filter with drain tap, for flow rate 0-40 GPM

Maximum pressure 580 PSI. Filter with two inlets and two outlets for air blast sprayers for vineyard and orchard sprayers. Inlet ports are 1/2" BSPF ports for 3/4" BSPF.



MODEL	DESCRIPTION	LIST PRICE
AGVMF003.12	Brass filter 1/2" BSP ports	\$117.74
AGVMF003.34	Brass filter 3/4" BSP ports	\$117.74
AGVMF50040	40 mesh filter element	\$19.97
AGVMF50070	70 mesh filter element	\$22.73
AGVMF50100	100 mesh filter element	\$23.41

725 psi

Filter for Spraying rated at 725 PSI Maximum pressure



MODEL	DESCRIPTION	LIST PRICE
AGFM004.12	Brass filter 1/2" BSPM with swivel nut	\$275.42
AGVMF60010	10 mesh filter element	\$55.08
AGVMF60050	50 mesh filter element	\$55.08



Accessories

AGRICULTURAL HIGH PRESSURE SPRAY LANCES

725 psi

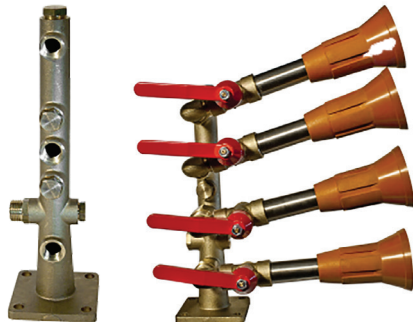

Column Sprayer Boom

Available as bare column or complete with spray lances. Adjustable atomization for spraying trees, orchards, and vineyards, rated pressure up to 725 PSI

MODEL	MAX PSI	DESCRIPTION	LIST PRICE
AGVMCOL38	725 PSI	Bare Column Spraying Boom	\$99.84
AGVMCOL038C	725 PSI	Spray Column with 4 spray Lances	\$537.07

725 psi

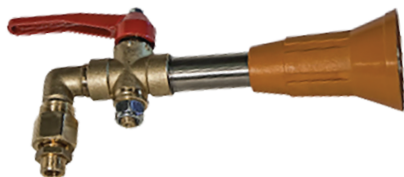

Agricultural Spray Lance

Features adjustable atomizing diffuser & individual lever shutoff at the nozzle. Adjustable Diffuser controls atomization of spraying trees, orchards, vineyards, and right of ways.

MODEL	MAX PSI	MAX GPM	STD. NOZZLE SIZE	INLET	LIST PRICE
AGVML009.14	725 PSI	8 GPM	1.5 mm	1/4" BSP-M	\$118.43
AGVML009.38	725 PSI	8 GPM	1.5 mm	3/8" BSP-M	\$120.50

725 psi

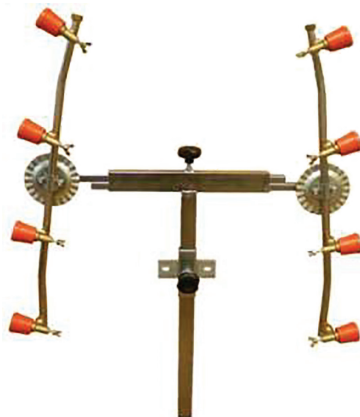

T-Shaped Spray Boom Complete with Butterfly Nozzles

Maximum operating pressure of 725 PSI. For use on trailed and towed sprayers for spraying vineyards, orchards and trees.

MODEL	DESCRIPTION	LIST PRICE
AGVMT001.3.3	Spray Boom with 3 Butterfly Nozzles on each side	\$585.27
AGVMT001.4.4	Spray Boom with 4 Butterfly Nozzles on each side	\$667.89
AGVMT001.5.5	Spray Boom with 5 Butterfly Nozzles on each side	\$778.06



Accessories

PRESSURE RELIEF VALVE



AGRV0022



AGRV0102

Pressure relief valve resistant to liquid and abrasive chemicals. Pressure relief valves maintain a constant maximum pressure by-passing excess flow. Relief valve in diaphragm version for maintaining accurate regulating pressure.

MODEL	PORTS	CONSTRUCTION	MAX PSI	LIST PRICE
AGRV0102	1" and 1/4" BSP	Nylon	290	\$155.01
AGRV0022	1 1/2" and 2" BSP	Nylon	290	\$328.24

PRESSURE REGULATOR VALVE



Nylon Pressure Regulator Valve, T-Handle pressure adjustment, 3/4" NPT Ports.

MODEL	DESCRIPTION	LIST PRICE
AGRV9257	Regulator Valve 150 PSI	\$16.32

TANK & CONTAINER RINSING ROTATING NOZZLES



AGRN8399

Tank rinsing nozzle performs 360 degree tank rinse. Supplied with a 1/2" hose barb connection.

MODEL	DESCRIPTION	LIST PRICE
AGRN8399	Tank rinsing nozzle	\$91.77



AGRN0839R

Tank rinsing nozzle performs 360 degree tank rinse. Supplied with a 1/2" hose barb connector and on-off valve.

MODEL	DESCRIPTION	LIST PRICE
AGRN0839R	Tank rinsing nozzle	\$151.83



AGRN1165V

Chemical container rinse nozzle. Sharp edges of the rinse nozzle puncture the chemical container seal for operator safety. The nozzle rinses out the containers before disposal.

MODEL	DESCRIPTION	LIST PRICE
AGRN1165V	Chemical container rinsing nozzle	\$123.59



AGRN0299

Rotating Spray Nozzles for tank cleaning, inlet is 1/2" hose barb. Rotating nozzles have full 360 degree coverage.

MODEL	DESCRIPTION	LIST PRICE
AGRN0299	Tank rinsing nozzle	\$183.61



AGRN5614CP

Rotating Spray Nozzle, for tank cleaning full 360 degree coverage. Extension can be built to order to meet varying tank sizes and shapes.

MODEL	DESCRIPTION	LIST PRICE
AGRN5614CP	Tank rinsing nozzle	\$271.89



Accessories

POWDER MIXING ACCESSORIES

Powder Mixing Accessory is installed in the mixer hopper and mixes and dissolves powders, facilitating mixing them with water. It is made of anti-corrosive material and is pressure fed; its blade configuration allows the formation of a vortex inside the hopper to aid mixing.



Powder Mixing Accessory combined with chemical container rinse nozzle

MODEL	DESCRIPTION	LIST PRICE
AGMA3314.2	Powder mixing accessory	\$215.39



Powder Mixing Rotating Accessory in Vertical Mount Configuration

MODEL	DESCRIPTION	LIST PRICE
AGMA3314.1	Powder mixing accessory	\$77.65



Powder Mixing Accessory in Horizontal Mount Configuration

MODEL	DESCRIPTION	LIST PRICE
AGMA3314	Powder mixing accessory	\$84.71



Accessories

SPRAYER CONTROL

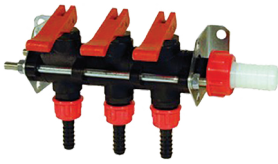

MODEL	DESCRIPTION	LIST PRICE
AGSC9003	Manual Spray Control, 3 Way	\$139.10

CHECK VALVE

Check valves allow flow in one direction. O-rings are Viton® and internal parts are stainless steel.

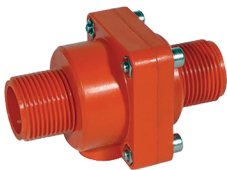

MODEL	DESCRIPTION	LIST PRICE
AGCV4248	Check Valve 1 1/2" NPT, 53 GPM Max	\$144.77

INSTALLATION TOOLS

Installation and removal tool for spray tips. Makes installation and removal easy and safe.



Universal



Hypro

MODEL	DESCRIPTION	LIST PRICE
AGIT4911	Installation Tool, Nozzle Cap, Universal	\$70.62
AGIT4974	Installation Tool, Nozzle Cap, Hypro	\$70.62

BULK HEAD FITTINGS

Polypropylene Bulkhead Fittings with Santoprene Gasket simplify the attachment of the tank plumbing.

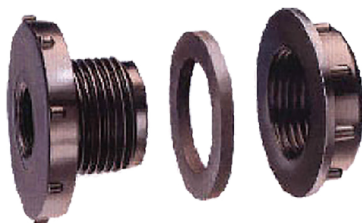

MODEL	DESCRIPTION	LIST PRICE
AGBH12	Bulkhead Fitting 1/2"	\$15.25
AGBH34	Bulkhead Fitting 3/4"	\$15.25
AGBH100	Bulkhead Fitting 1"	\$19.80
AGBH114	Bulkhead Fitting 1-1/4"	\$21.40
AGBH112	Bulkhead Fitting 1-1/2"	\$20.44
AGBH200	Bulkhead Fitting 2"	\$25.73
AGBH300	Bulkhead Fitting 3"	\$52.43
AGBH400	Bulkhead Fitting 4"	\$131.61



Accessories

CLAMPS

Clamps are for ball valves and other accessories that use the Universal flange. These clamps are easy to install and are UV protected.



MODEL	SIZE	PORT	LIST PRICE
AGUC100	M100	Full	\$14.34
AGUC200	M200	Standard	\$16.60
AGUC220	M220	Full	\$19.11
AGUC300	M300	Full	\$22.63

BALL VALVE

5 way configuration with Teflon® gaskets. O-rings are Viton® and internal parts are stainless steel.



5 way ball valve in corrosion resistant I.X.E.F. material

MODEL	DESCRIPTION	LIST PRICE
AGBV3500	Ball Valve 1 1/2", 53 GPM, 725 PSI	\$581.49



CAM LOCK COUPLERS

Cam lever couplings

Our comprehensive range of cam lever couplings are made from glass reinforced polypropylene for strength and durability, featuring stainless.

They are interchangeable with other couplers and adapters.

NBR standard gaskets



Male adapter » Female thread

A

PART No.	SIZE	F	LIST PRICE
AG8034226	3/4"	3/4 NPT	\$4.98
AG8034276	1"	1 NPT	\$4.98
AG8034376	1 1/2"	1 1/2" NPT	\$6.06
AG8034426	2"	2 NPT	\$6.66

Female coupler » Male thread

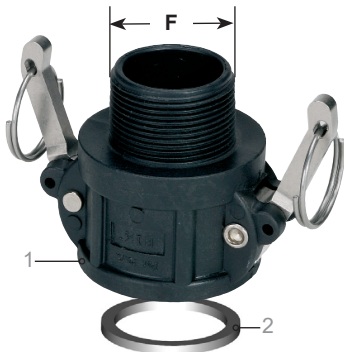
B

PART No. 1 & 2	SIZE	F	LIST PRICE
AG8034227	3/4"	3/4 NPT	\$18.16
AG8034277	1"	1 NPT	\$18.83
AG8034326	1 1/4"	1 1/4" NPT	\$21.52
AG8034377	1 1/2"	1 1/2" NPT	\$31.68
AG8034427	2"	2 NPT	\$31.68
AG8034526	3"	3 NPT	\$40.16

SPARE PARTS No. 2	
PART No.	LIST PRICE
AGG00002063	\$0.70
AGG00002062	\$0.82
AGG00002061	\$2.00
AGG00002060	\$2.49
AGG00002059	\$1.10
AGG00002058	\$6.37



CAM LOCK COUPLERS

Female coupler » Hosetail



PART No. 1 & 2	SIZE	Ø MM	LIST PRICE
AG8034203	3/4"	19	\$19.98
AG8034253	1"	25	\$21.95
AG8034304	1 1/4"	32	\$33.47
AG8034354	1 1/2"	38	\$33.51
AG8034403	2"	50	\$36.10
AG8034503	3"	75	\$55.90

SPARE PARTS No. 2	
PART No.	LIST PRICE
AGG00002063	\$0.70
AGG00002062	\$0.82
AGG00002061	\$2.00
AGG00002060	\$2.49
AGG00002059	\$1.10
AGG00002058	\$6.37

Female coupler » Female thread

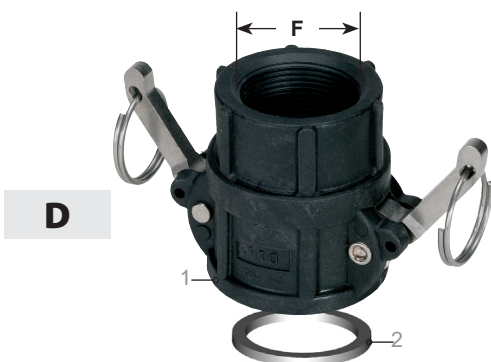

PART No. 1 & 2	SIZE	F	LIST PRICE
AG8034229	3/4"	3/4" NPT	\$18.77
AG8034279	1"	1" NPT	\$19.51
AG8034328	1 1/4"	1 1/4" NPT	\$31.68
AG8034379	1 1/2"	1 1/2" NPT	\$33.22
AG8034429	2"	2" NPT	\$38.81
AG8034527	3"	3" NPT	\$56.50

SPARE PARTS No. 2	
PART No.	LIST PRICE
AGG00002063	\$0.70
AGG00002062	\$0.82
AGG00002061	\$2.00
AGG00002060	\$2.49
AGG00002059	\$1.10
AGG00002058	\$6.37

Male adapter » Hosetail



PART No.	SIZE	Ø INCH	LIST PRICE
AG8034205	3/4"	3/4"	\$4.93
AG8034255	1"	1"	\$5.40
AG8034307	1 1/4"	1 1/4"	\$10.13
AG8034357	1 1/2"	1 1/2"	\$10.90
AG8034405	2"	2"	\$12.47
AG8034505	3"	3"	\$20.73



CAM LOCK COUPLERS

Male adapter » Male thread

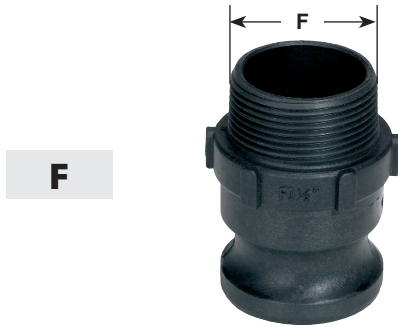

PART No.	SIZE	F	LIST PRICE
AG8034230	3/4"	3/4 NPT	\$5.32
AG8034280	1"	1 NPT	\$5.51
AG8034329	1 1/4"	1 1/4 NPT	\$6.18
AG8034380	1 1/2"	1 1/2 NPT	\$6.18
AG8034430	2"	2 NPT	\$7.39
AG8034528	3"	3 NPT	\$16.81

Cap for female coupler



PART No. 1 & 2	SIZE	LIST PRICE
AG8034207	3/4"	\$20.23
AG8034257	1"	\$22.34
AG8034309	1 1/4"	\$33.21
AG8034359	1 1/2"	\$32.46
AG8034407	2"	\$33.77
AG8034507	3"	\$53.19

SPARE PARTS No. 2	
PART No.	LIST PRICE
AGG00002063	\$0.70
AGG00002062	\$0.82
AGG00002061	\$2.00
AGG00002060	\$2.49
AGG00002059	\$1.10
AGG00002058	\$6.37

Cap for male adapter



PART No.	SIZE	LIST PRICE
AG8034208	3/4"	\$5.46
AG8034258	1"	\$5.06
AG8034310	1 1/4"	\$7.37
AG8034360	1 1/2"	\$7.37
AG8034408	2"	\$10.13
AG8034508	3"	\$15.58



Accessories

12V DIAPHRAGM PUMP

Positive Displacement 12 VDC Diaphragm Pump. Pressure Switch. Self Priming to 4', with Run Dry Capability.

NEW



MODEL	CONNECTION	MAX GPM	MAX PSI	LIST PRICE
AG12V1	3/8" Hose Barb	1	45	\$49.38



MODEL	DESCRIPTION	LIST PRICE
AGWH001	Wiring Harness w/Battery Clips, Fuse, On-Off Switch, 120° Length Connection: Std Quick Connect	\$18.17

Use with AG12V1 Pump

MODEL	DESCRIPTION	LIST PRICE
AGWH002	Heavy Duty Wiring Harness On-Off Switch with Battery Clamps	\$73.23

LOW PRESSURE 12V SPRAY GUNS

Low Pressure Spray Gun, Lightweight, with 3/8" Hose Barb connection, with Adjustable Nozzle from cone to straight stream.



AGSG5000

AGSG5005

MODEL	DESCRIPTION	LIST PRICE
AGSG5000	600 mm low pressure gun	\$12.45
AGSG5005	1500 mm low pressure gun	\$16.63



Accessories

HYDRAULIC DRIVEN PRESSURE WASHERS

MODEL	DESCRIPTION	LIST PRICE
HYD-RK1520-1000	Heavy Duty Triplex Plunger Pump	\$1,926.00



- Heavy Duty Triplex Plunger Pump
- Efficient Hydraulic Motor
- 50 feet of Hose
- Ergonomic Spray Gun
- Hi-Lo Variable Angle Nozzle
- Chemical Injector
- 3 GPM
- 1000 PSI
- Unloader
- 3/8" Quick disconnect outlet
- 3/4" Garden Hose input

MODEL	DESCRIPTION	LIST PRICE
HYD-RK1520-1500	Heavy Duty Triplex Plunger Pump	\$1,926.00



- Heavy Duty Triplex Plunger Pump
- Efficient Hydraulic Motor
- 50 feet of Hose
- Ergonomic Spray Gun
- Hi-Lo Variable Angle Nozzle
- Chemical Injector
- 4 GPM
- 1500 PSI
- Unloader
- 3/8" Quick disconnect outlet
- 3/4" Garden Hose input

MODEL	DESCRIPTION	LIST PRICE
HYD-RK1520-2000	Heavy Duty Triplex Plunger Pump	\$1,926.00



- Heavy Duty Triplex Plunger Pump
- Efficient Hydraulic Motor
- 50 feet of Hose
- Ergonomic Spray Gun
- Hi-Lo Variable Angle Nozzle
- Chemical Injector
- 4 GPM
- 2000 PSI
- Unloader
- 3/8" Quick disconnect outlet
- 3/4" Garden Hose input



Diaphragm Warranty

LIMITED WARRANTY

Annovi Reverberi (A.R.) Diaphragm Pumps are warranted for a period of one (1) year to the original purchaser. This is from the date shipped from factory or U.S. Warehouse. All accessories are warranted for a period of 90 days.

Warranty covers manufacturing defects or workmanship; that may develop under normal use and service in a manner up to the directions and usage recommended by the manufacturer.

Warranty does not apply to misuse or when pump or accessory is altered or used in excess of recommended speeds, pressures, temperatures or handling fluids not suitable for pump or accessory material construction. Warranty does not apply to normal wear (such as but not limited to: diaphragms, valves and sealing o-rings), freight damage, freezing damage or damage caused by parts or accessories not supplied by AR North America, Inc.

Liability of manufacturer for warranty is limited to repair or replacement of parts only at the option of the manufacturer when such products are found to be of original defect or workmanship at the time it was shipped from factory. No credit or labor allowances will be given for product returned as defective. Warranty replacement will be shipped on freight allowed bases. AR North America will choose the method of transportation.

This warranty is in lieu of all other warranties, expressed or implied, including any warranty of merchantability and of any and all other obligations or liabilities on the part of the manufacturers or equipment. This warranty gives you specific legal rights, and you may also have other rights that vary from state to state.

WARRANTY RETURNS

Contact AR North America Service Department to receive a **Return Merchandise Authorization number (RMA#)** at 763-398-2008 ext. 215, or email aliciap@arnorthamerica.com.

A full description of the problem must be included with the returned merchandise, including model number, date of purchase, and from whom the product was purchased. This **RMA number** must be marked on the outside of the package. AR North America will not be liable for the freight damage incurred during shipping.

All products must be flushed of any chemical before being returned to AR North America for warranty consideration. AR North America reserves the right to scrap any product returned with unknown chemicals and refuse warranty.

Products must be shipped to:

AR North America
Attn: Service Department
140 81st Ave NE
Fridley, MN 55432

ORDER PROCEDURES

PHONE: AR North America's Sales Department, Monday through Friday, **763-398-2008** or **1-800-893-4235**.

FAX: AR North America at **763-398-2009** or **1-800-331-2762**, 24 hours a day, 7 days a week.
(When ordering by fax, give company name, account number, part number, product description, quantity and price.)

E-MAIL: AR North America Sales Department at - **info@arnorthamerica.com**
(When ordering by e-mail, type Supply Order in the subject line. Please provide company name, account number, part number, product description, quantity and price.)

MINIMUM ORDER REQUIREMENT: \$25.00

DROP SHIPMENTS: \$10.00 service fee.

SPECIAL SHIPPING: Instructions should be highlighted.

Prices are list, FOB Fridley, Minnesota.
Prices are subject to change without prior notification.





FOR EVERY INDUSTRY THE PISTON PUMP YOU NEED

The attention to detail and high quality components finished directly inside the company have been the main factors in developing a full range of piston pumps characterized by different technical characteristics suitable not only for cleaning but also for new applications such as misting, reverse osmosis and dust suppression.

AR piston pumps are compact, silent running, equipped with ceramic pistons to guarantee longer life and require minimal maintenance due to their reliability.

In addition, AR pumps can be associated with various accessories and equipped with hydraulic, petrol and electric engines including the Made in Italy Ravel electric motors, manufactured in a company belonging to the Group.

TABLE OF CONTENTS

	Triplex Plunger Pumps	P 105 - 107
	Hydraulic Drive Pump Units	P 107 - 108
	Accessories	P 109

Note: For the full line of pumps and accessories please request our 2022 Catalog - Lit 1



**NORTH
AMERICA**®
When Quality Matters



Triplex Plunger Pumps



RMV 3400 RPM D VERSION 3/4" WITH GAS ENGINE FLANGE 140° F - MAX WATER TEMP • 3/4" GHA INLET THREAD • 22MMX14M DISCHARGE THREAD • 2.2 OZ OIL CAPACITY										
MODEL	MAX GPM	MAX L/MIN	MAX PSI	MAX BAR	POWER EBHP	BORE DIA MM	STROKE MM	CRANKSHAFT ID STAMP	WEIGHT LBS.	LIST PRICE
RMV25G30D-EZ	2.5	9.5	3000	200	5.1	12	9.7	1	7.5	\$338.00



SRMW 3400 RPM D VERSION 7/8" WITH VERTICAL GAS FLANGE 140° F - MAX WATER TEMP • 3/4" GHA INLET THREAD • 22MMX14M DISCHARGE THREAD • 2.2 OZ OIL CAPACITY										
MODEL	MAX GPM	MAX L/MIN	MAX PSI	MAX BAR	POWER EBHP	BORE DIA MM	STROKE MM	CRANKSHAFT ID STAMP	WEIGHT LBS.	LIST PRICE
SRMW22G26-EZ ^A	2.2	8.3	2600	173	3.9	12	8.3	5	7.7	\$238.00
SRMW22G26-EZ-SX ^A	2.2	8.3	2600	173	3.9	12	8.3	5	7.7	\$238.00



RXV 3400 RPM D VERSION 3/4" WITH GAS ENGINE FLANGE 140° F - MAX WATER TEMP • 3/4" GHA INLET THREAD • 22MMX14M DISCHARGE THREAD • 3.35 OZ OIL CAPACITY										
MODEL	MAX GPM	MAX L/MIN	MAX PSI	MAX BAR	POWER EBHP	BORE DIA MM	STROKE MM	CRANKSHAFT ID STAMP	WEIGHT LBS.	LIST PRICE
RXV3G30D-EZ	3	11.4	3000	206	5.5	14	8.2	3	8.8	\$375.00



RSV 3400 RPM D VERSION 3/4" WITH GAS ENGINE FLANGE 140° F - MAX WATER TEMP • 3/8" F INLET THREAD • 3/8" F DISCHARGE THREAD • 16 OZ OIL CAPACITY										
MODEL	MAX GPM	MAX L/MIN	MAX PSI	MAX BAR	POWER EBHP	BORE DIA MM	STROKE MM	CRANKSHAFT ID STAMP	WEIGHT LBS.	LIST PRICE
RSV3G30DF25EZ	3	11.4	3000	206	6.2	15	7.6	9	14	\$583.00



RSV 3400 RPM D VERSION 1" WITH GAS ENGINE FLANGE 140° F - MAX WATER TEMP • 3/8" F INLET THREAD • 3/8" F DISCHARGE THREAD • 16 OZ OIL CAPACITY										
MODEL	MAX GPM	MAX L/MIN	MAX PSI	MAX BAR	POWER EBHP	BORE DIA MM	STROKE MM	CRANKSHAFT ID STAMP	WEIGHT LBS.	LIST PRICE
RSV4G40HDF40EZ	4	15.1	4000	275	11.0	15	9.4	7	14	\$649.00



RCV 3400 RPM D VERSION 3/4" WITH GAS ENGINE FLANGE 140° F - MAX WATER TEMP • 1/2" F INLET THREAD • 3/8" F DISCHARGE THREAD • 9.81 OZ OIL CAPACITY										
MODEL	MAX GPM	MAX L/MIN	MAX PSI	MAX BAR	POWER EBHP	BORE DIA MM	STROKE MM	CRANKSHAFT ID STAMP	WEIGHT LBS.	LIST PRICE
RCV3G27D-F7	3	11.4	2700	186	5.6	15	6.5	8	11	\$550.00



RRV 3400 RPM D VERSION 1" WITH GAS ENGINE FLANGE 140° F - MAX WATER TEMP • 1/2" F INLET THREAD • 3/8" F DISCHARGE THREAD • 13.35 OZ OIL CAPACITY										
MODEL	MAX GPM	MAX L/MIN	MAX PSI	MAX BAR	POWER EBHP	BORE DIA MM	STROKE MM	CRANKSHAFT ID STAMP	WEIGHT LBS.	LIST PRICE
RRV4G40HD-F24	4	15.1	4000	275	11.0	15	9.2	5	18	\$616.00

^A Aluminum / EZ - Easy Start Valve / SX - 180° Rotated Shaft Configuration



Triplex Plunger Pumps



RK 1450 RPM N VERSION 24MM SOLID SHAFT

140° F - MAX WATER TEMP • 1/2" F INLET THREAD • 3/8" F DISCHARGE THREAD • 15 OZ OIL CAPACITY

MODEL	MAX GPM	MAX L/MIN	MAX PSI	MAX BAR	POWER EBHP	BORE DIA MM	STROKE MM	CRANKSHAFT ID STAMP	WEIGHT LBS.	LIST PRICE
RK15.28HN	3.96	15	4000	275	11.0	18	14.6	1	20	\$820.00
RK18.28HN	4.75	18	4000	275	13.0	20	14.6	1	20	\$860.00



XW 1450 RPM N VERSION 24MM SOLID SHAFT

140° F - MAX WATER TEMP • 3/4" F INLET THREAD • 3/8" F DISCHARGE THREAD • 32 OZ OIL CAPACITY

MODEL	MAX GPM	MAX L/MIN	MAX PSI	MAX BAR	POWER EBHP	BORE DIA MM	STROKE MM	CRANKSHAFT ID STAMP	WEIGHT LBS.	LIST PRICE
XWM2128N	5.55	21	4060	280	15.5	20	16.6	3	34	\$1,210.00
XW3025N	7.92	30	3600	250	20.0	22	19.8	1	34	\$1,380.00



XWP 1450 RPM N VERSION 24MM SOLID SHAFT

140° F - MAX WATER TEMP • 1" F INLET THREAD • 1/2" F DISCHARGE THREAD • 31.8 OZ OIL CAPACITY

MODEL	MAX GPM	MAX L/MIN	MAX PSI	MAX BAR	POWER EBHP	BORE DIA MM	STROKE MM	CRANKSHAFT ID STAMP	WEIGHT LBS.	LIST PRICE
XWP50.15N	13.2	50	2200	150	20.0	30	16.6	10	39	\$1,880.00
XWP70.12N	18.5	70	1740	120	22.0	30	23	15	39	\$1,880.00



RTX 1450 RPM N VERSION 30 X 80 MM SOLID SHAFT

140° F - MAX WATER TEMP • 1" F INLET THREAD • 1/2" F DISCHARGE THREAD • 76 OZ OIL CAPACITY

MODEL	MAX GPM	MAX L/MIN	MAX PSI	MAX BAR	POWER EBHP	BORE DIA MM	STROKE MM	CRANKSHAFT ID STAMP	WEIGHT LBS.	LIST PRICE
RTX30	7.9	30	4350	300	23.6	20	23	3	72	\$3,210.00
RTX70	18.5	70	3000	206	38.1	30	23	3	72	\$3,210.00
RTX100	26.4	100	1800	124	33.0	36	23	3	72	\$3,210.00



RTD 1000 RPM N VERSION 35MM SOLID SHAFT

140° F - MAX WATER TEMP • 1 1/2" F INLET THREAD • 1" F DISCHARGE THREAD • 110 OZ OIL CAPACITY

MODEL	MAX GPM	MAX L/MIN	MAX PSI	MAX BAR	POWER EBHP	BORE DIA MM	STROKE MM	CRANKSHAFT ID STAMP	WEIGHT LBS.	LIST PRICE
RTD100-200	26.4	100	2900	200	53.0	32	42	3	128	\$6,270.00
RTD160-130	42.3	160	1900	130	55.2	40	42	3	128	\$6,270.00



RTP 1000 RPM N VERSION 35MM SOLID SHAFT

140° F - MAX WATER TEMP • 3/4" F INLET THREAD • 1/2" F DISCHARGE THREAD • 137 OZ OIL CAPACITY

MODEL	MAX GPM	MAX L/MIN	MAX PSI	MAX BAR	POWER EBHP	BORE DIA MM	STROKE MM	CRANKSHAFT ID STAMP	WEIGHT LBS.	LIST PRICE
RTP30.60N	7.9	30	8700	600	47.2	20	34	2	177	\$8,670.00



Triplex Plunger Pumps



RTF 800 RPM N VERSION 35MM SOLID SHAFT										
140° F - MAX WATER TEMP • 1 1/2" F INLET THREAD • 1" F DISCHARGE THREAD • 137 OZ OIL CAPACITY										
MODEL	MAX GPM	MAX L/MIN	MAX PSI	MAX BAR	POWER EBHP	BORE DIA MM	STROKE MM	CRANKSHAFT ID STAMP	WEIGHT LBS.	LIST PRICE
RTF135N	36	135	1500	103	37.0	40	48	3	192	\$8,870.00



RTJ 1000 RPM N VERSION 35MM SOLID SHAFT										
140° F - MAX WATER TEMP • 1 1/2" F INLET THREAD • 1" F DISCHARGE THREAD • 137 OZ OIL CAPACITY										
MODEL	MAX GPM	MAX L/MIN	MAX PSI	MAX BAR	POWER EBHP	BORE DIA MM	STROKE MM	CRANKSHAFT ID STAMP	WEIGHT LBS.	LIST PRICE
RTJ70	18.5	70	4000	275	50.8	25	48	3	198	\$9,280.00



Hydraulic Drive Pump Units with Mounting Rails Hydraulic Motor



RK 1450 RPM									
MOTOR: SAUER DANFOSS 1/2" - INLET AND OUTLET • PUMP: 1/2" F INLET AND 3/8" F OUTLET									
MODEL	PUMP				HYDRAULIC MOTOR				LIST PRICE
	MAX GPM	MAX L/MIN	MAX PSI	MAX BAR	MAX GPM	MAX L/MIN	MAX PSI	MAX BAR	
HYD-RK15.20	4	15.1	3000	206	7.5	29	2500	175	\$1,680.00



XW 1450 RPM									
MOTOR: SAUER DANFOSS 3/4" - INLET AND OUTLET • PUMP: 3/4" F INLET AND 3/4" F OUTLET									
MODEL	PUMP				HYDRAULIC MOTOR				LIST PRICE
	MAX GPM	MAX L/MIN	MAX PSI	MAX BAR	MAX GPM	MAX L/MIN	MAX PSI	MAX BAR	
HYD-XW30.10	8	30.2	2200	150	9.5	36	2610	180	\$2,300.00



Hydraulic Drive Pump Units

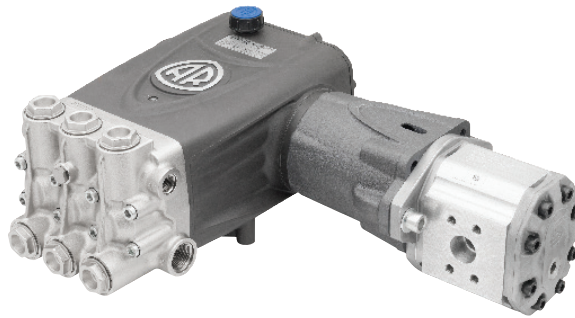

RTX 1450 RPM

MOTOR: SAUER DANFOSS 3/4" - INLET AND OUTLET • PUMP: 1" F INLET AND 1/2" F OUTLET

MODEL	PUMP				HYDRAULIC MOTOR				LIST PRICE
	MAX GPM	MAX L/MIN	MAX PSI	MAX BAR	MAX GPM	MAX L/MIN	MAX PSI	MAX BAR	
HYD-RTX30	7.92	30	4350	300	18.5	70	2175	150	\$5,250.00
HYD-RTX70	18.5	70	2200	180	18.5	70	2610	180	\$5,250.00
HYD-RTX100	26.4	100	1740	120	18.5	70	3046	210	\$5,250.00

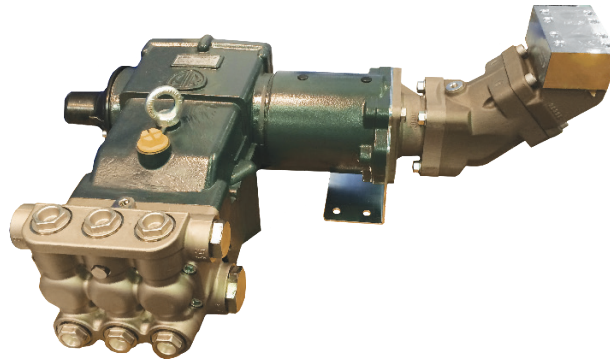

RTP 1450 RPM

MOTOR: SAUER DANFOSS 3/4" - INLET AND OUTLET • PUMP: 1" F INLET AND 1/2" F OUTLET

MODEL	PUMP				HYDRAULIC MOTOR				LIST PRICE
	MAX GPM	MAX L/MIN	MAX PSI	MAX BAR	MAX GPM	MAX L/MIN	MAX PSI	MAX BAR	
HYD-RTP38	10	38	7250	500	23.5	88	4060	280	\$16,420.00

RTF 800 RPM

MOTOR: SAUER DANFOSS 3/4" - INLET AND OUTLET • PUMP: 1" F INLET AND 1/2" F OUTLET

MODEL	PUMP				HYDRAULIC MOTOR				LIST PRICE
	MAX GPM	MAX L/MIN	MAX PSI	MAX BAR	MAX GPM	MAX L/MIN	MAX PSI	MAX BAR	
HYD-RTF135	36	135	1500	103	18.6	70.5	3555	245	\$17,030.00

RTJ 1000 RPM

MOTOR: SAUER DANFOSS 3/4" - INLET AND OUTLET • PUMP: 1" F INLET AND 1/2" F OUTLET

MODEL	PUMP				HYDRAULIC MOTOR				LIST PRICE
	MAX GPM	MAX L/MIN	MAX PSI	MAX BAR	MAX GPM	MAX L/MIN	MAX PSI	MAX BAR	
HYD-RTJ70	18.5	70	4000	275	23.5	88	4060	280	\$17,030.00



Accessories

VRT3 - Unloader



- 10.5 Max GPM
- 2x3/8" F Inlet
- 3/8" F Outlet
- 2 x 3/8" F By Pass
- 194° F Max Temperature

MODEL	MAX PSI	SPRING COLOR	KNOB	LIST PRICE
VRT3-310	4,500	Black	Yes	\$79.50
VRT3-310EZ*	4,500	Black	Yes	\$80.60

MV925 - Rear Entry Guns



MODEL	MAX PSI	MAX GPM	INLET	OUTLET	MAX TEMP	LIST PRICE
MV925	4,500	8	3/8" F	1/4" F	320° F	\$38.70

VHP39 - Unloader



- 5,560 Max PSI
- 11 Max GPM
- 190° F Max Temperature

MODEL	INLET	OUTLET	BY-PASS	LIST PRICE
VHP39	1 x 3/8" F	3/8" F	2 x 3/8" F	\$198.80

ML955 - Rear Entry Guns



MODEL	MAX PSI	MAX GPM	INLET	OUTLET	MAX TEMP	LIST PRICE
ML955	5,800	10.6	3/8" F	1/4" F	320° F	\$60.70

VR54 - Unloader



- 8 Max GPM
- 3/8" NPT M Inlet
- 3/8" NPT M Outlet
- 3/8" NPT F By-Pass
- 194° F Max Temperature

MODEL	MAX PSI	CAP COLOR	LIST PRICE
VR54-200	2,900	Red	\$65.50

VRT100 - Unloader



- 26.4 Max GPM
- 1/2" NPT F Inlet
- 1/2" NPT F Outlet
- 1/2" NPT F By-Pass
- 194° F Max Temperature

MODEL	MAX PSI	SPRING COLOR	KNOB	LIST PRICE
VRT100-330D	4,800	Blue	No	\$234.60



ROTARY VANE VACUUM PUMPS

Battioni Pagani has a full range of rotary vane vacuum pumps and blowers, ballast pumps and agricultural pumps that are air cooled, air injection cooled, liquid cooled, self-priming, lobe transfer and centrifugal pumps for agriculture, industrial or virtually any application. Battioni Pagani is "your choice without compromise."

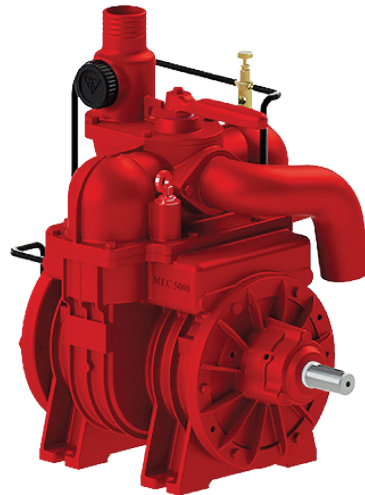

TABLE OF CONTENTS

MEC	P 111
MEC Gas Engine	P 112
Ballast	P 113 - 114
WPT	P 114
KPS	P 115
FAN	P 115
Turnkey Systems	P 116



Rotary Vane Vacuum Pump - Air Cooling



MEC/P



MEC/M



600 / 1400 Max RPM
36.26 Max Absolute (relative) Pressure

MODEL		L/MIN	CFM	MAX RPM	MAX ABSOLUTE (RELATIVE) (PSI)	GEOMETRIC CAPACITY (GPM)	WEIGHT (LBS)
MEC2000	P LA DX UL D51 EM	2750	97	600/1400	36.26	726.47	165
MEC2000SX	P LA SX UL D51 EM	2750	97	600 / 1400	36.26	726.47	165
MEC4000	P LA DX UL D51 EM	4350	154	600 / 1400	36.26	1149.15	221
MEC4000SX	P LA SX UL D51 EM	4350	154	600 / 1400	36.26	1149.15	221
MEC4000LF	P FL DX UL D51 EM	4350	154	600 / 1400	36.26	1149.15	221
MEC5000*	P LA DX UL D51 EM	6150	217	600 / 1400	36.26	1624.66	287
MEC5000SX	P LA SX UL D51 EM	6150	217	600 / 1400	36.26	1624.66	287
MEC5000MSX	M LF SX UL 76 STD	6150	217	600 / 1400	36.26	1624.66	287
MEC6500*	P LA DX UL D76 EM	7000	247	600 / 1400	36.26	1849.2	326
MEC6500SX	P LA SX UL D76 EM	7000	247	600 / 1400	36.26	1849.2	326
MEC6500MSX	M LF SX UL 76 EM	7000	247	600 / 1400	36.26	1849.2	326
MEC8000*	P LA DX UL D76 EM	8100	286	600 / 1400	36.26	2139.79	353
MEC8000SX	P LA SX UL D76 EM	8100	286	600 / 1400	36.26	2139.79	353
MEC8000MSX	M LF SX UL 76 EM	8100	286	600 / 1400	36.26	2139.79	353

*Call for pricing.

*Units come with the over pressure valve installed



KITS	
MODEL	DESCRIPTION
BP6010201064	MEC2000 LL KIT
BP6010201061	MEC4000 LL KIT
BP6010201058	MEC5000 LL KIT
BP6010201006	MEC5000 STD KIT

*Call for pricing.

KITS	
MODEL	DESCRIPTION
BP6010201059	MEC6500 LL KIT
BP6010201007	MEC6500 STD KIT
BP6010201060	MEC8000 LL KIT
BP6010201008	MEC8000 STD KIT

*Call for pricing.



Rotary Vane Vacuum Pump - Air Cooling - Gas Engine



MEC 

600 / 1400 Max RPM
36.26 Max Absolute (relative) Pressure
MEC2000GE with Honda Gas Engine - GX270

MODEL		L/MIN	CFM	MAX RPM	MAX ABSOLUTE (RELATIVE) (PSI)	POWER ABSORPTION MAX VACUUM (HP)	WEIGHT (LBS)
MEC2000-GE	Gas Engine	2750	97	600 / 1400	36.26	13.4	165

*Call for pricing.



MEC 

600 / 1400 Max RPM
36.26 Max Absolute (relative) Pressure
MEC4000GE with Honda Gas Engine - GX390

MODEL		L/MIN	CFM	MAX RPM	MAX ABSOLUTE (RELATIVE) (PSI)	POWER ABSORPTION MAX VACUUM (HP)	WEIGHT (LBS)
MEC4000-GE	Gas Engine	4350	154	600 / 1400	36.26	21.5	221

*Call for pricing.



Rotary Vane Vacuum Pump - Air Injection Cooling



Ballast

600 / 1000 Max RPM
 36.26 Max Absolute (relative) Pressure
 -13.78 Vacuum without Depression Valve Fitted
 -11.6 Vacuum with Depression Valve Fitted

MODEL		L/MIN	CFM	MAX RPM	MAX ABSOLUTE (RELATIVE) (PSI)	GEOMETRIC CAPACITY (GPM)	WEIGHT (LBS)
BALLAST 9000	P LA DX UL D76 EM	9030	319	600 / 1000	36.26	2.85	320
BALLAST 9000SX	P LA SX UL D76 EM	9030	319	600 / 1000	36.26	2.85	320
BALLAST 11000	P LA DX UL D76 EM	11137	393	600 / 1000	36.26	2.94	353
BALLAST 11000SX	P LA SX UL D76 EM	11137	393	600 / 1000	36.26	2.94	353
BALLAST13500	P LA DX UL D76 EM	13845	489	600 / 1000	36.26	3.66	362

***Call for pricing.**



Standard Vane Kit

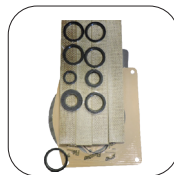

Long Life Vane Kit



Kevlar® Long Life Vane Kit

*Standard and Long Life rebuilt kits include seals, gaskets, and vanes.

*Kevlar Long Life rebuilt kits include seals, gaskets, vanes, and bolts.

KITS	
MODEL	DESCRIPTION
BP6010201055	BALLAST11000 KIT
BP6010201056	BALLAST13500 KIT
BP6010201054	BALLAST9000 KIT

***Call for pricing.**



Rotary Vane Vacuum Pump - Air Injection Cooling

Ballast

600 / 1000 Max RPM
 36.26 Max Absolute (relative) Pressure
 -13.78 Vacuum without Depression Valve Fitted
 -11.6 Vacuum with Depression Valve Fitted

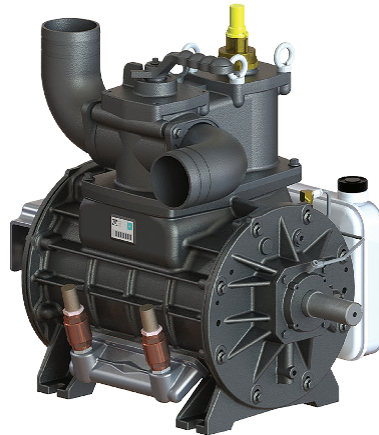

MODEL	GEOMETRICAL CAPACITY			MAX RPM			WEIGHT			
	m/h	L/MIN	CFM	M/K	P/D/H	MA/KA	M	P/D	H	K/A
BALLAST 16000	913	15210	537	600	1400	1000	506	462	473	484

*Call for pricing.



Rotary Vane Vacuum Pump - WPT Series

WPT

1000 Max RPM
 Long Life Blades
 Integrated Cooling Pump
 Four(4) Way Valve
 Automatic Lubrication by copper pipes
 Side Outlets
 Exhaust Elbows
 Depression Valve 1-1/2"
 Over Pressure Valves 2"

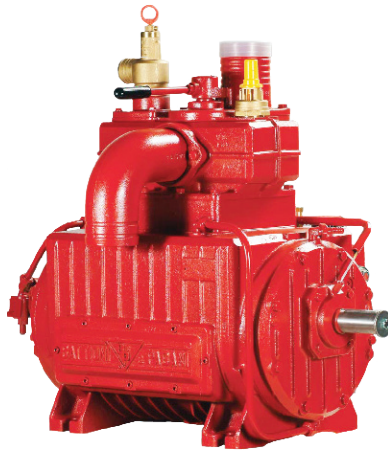

MODEL		L/MIN	CFM	MAX RPM	WEIGHT (LBS)
WPT480	PFR LA DX UL D76 EM	9700	342,5	1000	573
WPT480SX	PFR LA SX UL D76 EM	9700	416,7	1000	573
WPT720	PFR LA DX UL D76 EM	14200	501,4	1000	789
WPT720SX	PFR LA SX UL D76 EM	14200	501.4	1000	789

*Call for pricing.

KITS	
MODEL	DESCRIPTION
BP6010201033	WPT/FR 480 KIT
BP6010201035	WPT/FR 720 KIT

Units come with the over pressure valve installed



*Call for pricing.



Rotary Vane Vacuum Pump - KPS Series

KPS

- 1400 Max RPM
- Long Life Blades
- Integrated Cooling Pump
- Four(4) Way Valve
- Automatic Lubrication by copper pipes
- Side Outlets
- Exhaust Elbows
- Depression Valve 1-1/2"
- Over Pressure Valves 2"



MODEL		L/MIN	CFM	MAX RPM	MAX WORKING PRESSURE (PSI)	WEIGHT (LBS)
KPS-B490	P LA DX UL D76	13520	477	1400	2.5 (36)	452
KPS-B550	P LA DX UL D100	15270	539	1400	2.5 (36)	476
KPS-B670	P LA DX UL D100	18620	657	1400	2.5 (36)	540

*Call for pricing.

Units come with the over pressure valve installed



Rotary Vane Vacuum Pump - FAN Series

FAN

- 1500 Max RPM
- Long Life Blades
- Crash Protection
- System Automatic Lubrication
- External Side Oil Tank
- Integrated Air Filter
- Four (4) ways valve
- Poppet Check valve
- Available hoses connections: ø76mm(3") / ø100mm(4")

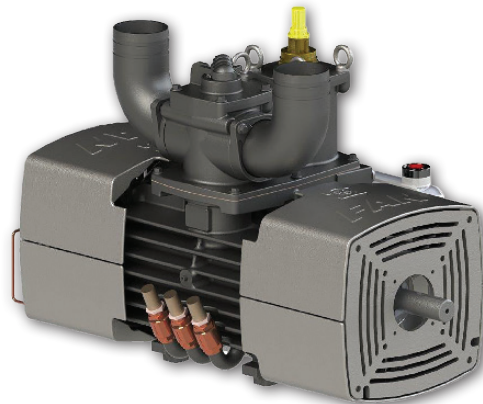

MODEL		L/MIN	CFM	MAX RPM	MAX PRESSURE (PSI)	WEIGHT (LBS)
FAN-B420	P UL D76	11980	423	1500	2.5 (36)	448
FAN-B530	P UL D76	14890	525	1500	2.5 (36)	580

*Call for pricing.

Units come with the over pressure valve installed





MAX PACKS

- Pump
- Right Angle Gearbox
- Auto Align Bracket
- Final Filter
- Secondary
- Muffler
- Vacuum Relief Valve
- Pressure Relief Valve
- Powder Coated Pump Stand

MODEL	CAPACITY	COOLING TECH
MEC9000	320CFM	Ballast Port
MEC11000	394CFM	Ballast Port
MEC13500	489CFM	Ballast Port
FAN420	423CFM	Dual Fan
KPS490	477CFM	Liquid

PUMP STAND COMPLETE PACKAGE

- Pump
- Gearbox
- Auto Align Bracket
- Pump Coupling

MODEL	CAPACITY	COOLING TECH
MEC9000	320CFM	Ballast Port
MEC11000	394CFM	Ballast Port

MUFFLER PACKS

- Pump
- Right Angle Gearbox
- Auto Align Bracket
- Pump Stand
- Oil Catch Muffler

MODEL	CAPACITY	COOLING TECH
MEC9000	320CFM	Ballast Port
MEC11000	394CFM	Ballast Port
MEC13500	489CFM	Ballast Port
FAN420	423CFM	Dual Fan
KPS490	477CFM	Liquid

ENGINE DRIVE UNITS

- Pump Drive Systems for applications that require stand alone apparatus
- Mount on a truck or a trailer and do not require a power take-off or other drive
- Ideal for portable service units
- Electric Start Honda Engines from 8-13HP
- Fully assembled on pump stand - your choice of pumps

MODEL	CAPACITY
MEC2000	90CFM

*Call for more details and pricing for new turnkey systems.



SUPEREX CLAMPS

TABLE OF CONTENTS

T-Bolt Super Clamps	P 118
Superextra Single Bolt Clamp	P 119
Superextra Double Bolt Clamp	P 120 - 121
Spiral Clamp	P 121
Whipcheck	P 122



Superex Clamps

SUPER CLAMP

Construction: Bolt: T Head bolt grade 8.8, available in Galvanized Steel and Stainless Steel AISI 304

Feature: Superex clamps are heavy duty clams having high band tension; designed for sealing suction and pressure lines. Smooth underside and rolled-up band edges are gentle on the hose and reduce risk of leakages. Uniquely designed bridge for clamp provides optional hose protection. Contains three welding points for increased security for large sizes. Hollow rollers provide high uniform torque and eliminate chances of damage to the band.

Application: Heavy duty clamp for heavy gauge reinforced hoses used for agriculture and industrial usage. Main applications include vehicle construction, agricultural machines and vehicles, ship building, recycling, biogas, industrial plant construction, rail vehicles, construction industry, etc.

T-BOLT SUPER CLAMP

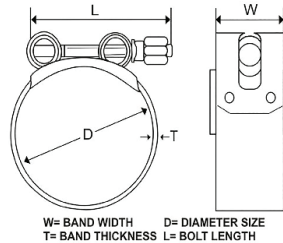

W= BAND WIDTH
T= BAND THICKNESS
D= DIAMETER SIZE
L= BOLT LENGTH



T-Bolt Super Clamp

GALVANIZED STEEL (W1)

MODEL	BOLT	BANDWIDTH	BAND THICKNESS	LIST PRICE
17-19 W1	5/8"-3/4"	7/10"	1/50"	\$1.26
20-22 W1	5/8"-3/4"	7/10"	1/50"	\$1.26
23-25 W1	7/8"-1"	7/10"	1/50"	\$1.35
26-28 W1	1"-1 1/8"	7/10"	1/50"	\$1.35
29-31 W1	1 1/8"-1 1/4"	4/5"	6/50"	\$1.53
32-35 W1	1 1/4"-1 3/8"	4/5"	6/50"	\$1.62
36-39 W1	1 3/8"-1 1/2"	4/5"	6/50"	\$1.71
40-43 W1	1 1/2"-1 11/16"	4/5"	6/50"	\$4.28
44-47 W1	1 11/16"-1 7/8"	4/5"	2/50"	\$2.34
48-51 W1	1 7/8"-2"	4/5"	2/50"	\$2.34
52-55 W1	2"-2 3/16"	4/5"	2/50"	\$2.43
56-59 W1	2 3/16"-2 5/16"	4/5"	2/50"	\$2.52
60-63 W1	2 5/16"-2 1/2"	4/5"	2/50"	\$2.52
64-67 W1	2 1/2"-2 5/8"	4/5"	2/50"	\$2.61
68-73 W1	2 5/8"-2 7/8"	47/50"	3/50"	\$3.42
74-79 W1	2 7/8"-3 1/8"	47/50"	3/50"	\$3.51
80-85 W1	3 1/8"-3 5/16"	47/50"	3/50"	\$3.60
86-91 W1	3 3/8"-3 11/16"	47/50"	3/50"	\$3.78
92-97 W1	3 11/16"-3 13/16"	47/50"	3/50"	\$3.78
98-103 W1	3 13/16"-4 1/16"	47/50"	3/50"	\$3.87
104-112 W1	4 1/16"-4 7/16"	47/50"	3/50"	\$3.96
113-121 W1	4 7/16"-4 3/4"	47/50"	3/50"	\$4.14
122-130 W1	4 3/4"-5 1/8"	47/50"	3/50"	\$4.23
131-139 W1	5 1/8"-5 1/2"	47/50"	3/50"	\$5.58
140-148 W1	5 1/2"-5 7/8"	1 1/50"	3/50"	\$5.67
149-161 W1	5 7/8"-6 5/16"	1 1/50"	3/50"	\$6.03
162-174 W1	6 5/16"-6 7/8"	1 1/50"	3/50"	\$6.30
175-187 W1	6 7/8"-7 3/8"	1 1/50"	3/50"	\$6.39
188-200 W1	7 3/8"-7 7/8"	1 1/50"	3/50"	\$6.66
201-213 W1	7 7/8"-8 3/8"	1 1/50"	3/50"	\$6.66
214-226 W1	8 3/8"-8 7/8"	1 1/50"	3/50"	\$6.93
227-239 W1	8 7/8"-9 3/8"	1 1/50"	3/50"	\$7.02
240-252 W1	9 3/8"-9 15/16"	1 1/50"	3/50"	\$7.29
254-267 W1	9 15/16"-10 1/2"	1 1/50"	3/50"	\$7.83
304-316 W1	11 15/16"-12 7/16"	1 1/50"	3/50"	\$8.10

STAINLESS STEEL AISI 304 (W4)

MODEL	BOLT	BANDWIDTH	BAND THICKNESS	LIST PRICE
29-31 W4	1 1/8"-1 1/4"	4/5"	6/50"	\$7.83
32-35 W4	1 1/4"-1 3/8"	4/5"	6/50"	\$8.10
36-39 W4	1 3/8"-1 1/2"	4/5"	6/50"	\$4.23
40-43 W4	1 1/2"-1 11/16"	4/5"	6/50"	\$4.32
44-47 W4	1 11/16"-1 7/8"	4/5"	6/50"	\$4.41
48-51 W4	1 7/8"-2"	4/5"	6/50"	\$4.65
52-55 W4	2"-2 3/16"	4/5"	6/50"	\$5.04
56-59 W4	2 3/16"-2 5/16"	4/5"	6/50"	\$5.13
60-63 W4	2 5/16"-2 1/2"	4/5"	6/50"	\$5.40
64-67 W4	2 1/2"-2 5/8"	4/5"	6/50"	\$5.58
68-73 W4	2 5/8"-2 7/8"	47/50"	1/25"	\$5.76
74-79 W4	2 7/8"-3 1/8"	47/50"	1/25"	\$5.94
80-85 W4	3 1/8"-3 5/16"	47/50"	1/25"	\$7.47
86-91 W4	3 3/8"-3 11/16"	47/50"	1/25"	\$7.65
92-97 W4	3 11/16"-3 13/16"	47/50"	1/25"	\$7.92
98-103 W4	3 13/16"-4 1/16"	47/50"	1/25"	\$8.01
104-112 W4	4 1/16"-4 7/16"	47/50"	1/25"	\$8.37
113-121 W4	4 7/16"-4 3/4"	47/50"	1/25"	\$8.46
122-130 W4	4 3/4"-5 1/8"	47/50"	1/25"	\$9.18
131-139 W4	5 1/8"-5 1/2"	47/50"	1/25"	\$9.27
140-148 W4	5 1/2"-5 7/8"	1 1/50"	1/25"	\$9.72
149-161 W4	5 7/8"-6 5/16"	1 1/50"	1/25"	\$13.77
162-174 W4	6 5/16"-6 7/8"	1 1/50"	1/25"	\$14.04
175-187 W4	6 7/8"-7 3/8"	1 1/50"	1/25"	\$15.03
188-200 W4	7 3/8"-7 7/8"	1 1/50"	1/25"	\$15.21
201-213 W4	7 7/8"-8 3/8"	1 1/50"	1/25"	\$15.48
214-226 W4	8 3/8"-8 7/8"	1 1/50"	1/25"	\$16.20
227-239 W4	8 7/8"-9 3/8"	1 1/50"	1/25"	\$16.38
240-252 W4	9 3/8"-9 15/16"	1 1/50"	1/25"	\$16.65
254-267 W4	9 15/16"-10 1/2"	1 1/50"	1/25"	\$17.37
304-316 W4	11 15/16"-12 7/16"	1 1/50"	1/25"	\$17.64



Superex Clamps

SUPEREXTRA SINGLE BOLT CLAMP

Construction: Bolt: Socket head grade 8.8. Available in Galvanized Steel, Stainless Steel AISI 304 and AISI 316.

Feature: Clamp has a double band making it a very strong heavy duty clamp. Bridge welded onto lamp for optional hose protection. Solid metal rollers complement the strength of the double band. Socket head screws allow for easy installation with allen key.

Application: Double bank make clamp ideal for heavy applications. Main applications are heavy vehicles and industrial machinery. Availability of clamp in AISI 316 make it popular for use in marine and offshore applications.

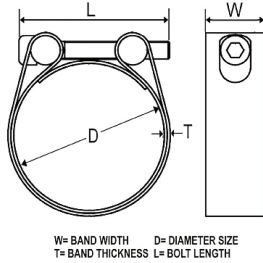

Single Bolt Clamp

GALVANIZED STEEL (W1)

MODEL	SIZE	BOLT	BAND-WIDTH	BAND THICKNESS	LENGTH	LIST PRICE
S-35 W1	30 - 36	1 3/16"-1 7/16"	4/5"	1/50"	1 4/5"	\$3.06
S-40 W1	35 - 41	1 3/8"-1 5/8"	4/5"	1/50"	1 4/5"	\$3.15
S-45 W1	40 - 46	1 9/16"-1 13/16"	4/5"	1/50"	1 4/5"	\$3.15
S-50 W1	45 - 51	1 3/4"-2"	4/5"	1/50"	1 4/5"	\$3.24
S-55 W1	50 - 56	2"-2 3/16"	4/5"	1/50"	1 4/5"	\$3.33
S-60 W1	55 - 61	2 3/16"-2 3/8"	4/5"	1/50"	1 4/5"	\$3.42
S-65 W1	60 - 66	2 3/8"-2 5/8"	4/5"	1/50"	1 4/5"	\$3.69
S-70 W1	65 - 71	2 9/16"-2 13/16"	4/5"	1/50"	1 4/5"	\$3.78
S-75 W1	70 - 76	2 3/4"-3"	4/5"	1/50"	1 4/5"	\$3.78
S-80 W1	75 - 76	2 15/16"-3 3/16"	4/5"	1/50"	1 4/5"	\$3.87
S-85 W1	80 - 86	3 1/8"-3 3/8"	4/5"	1/50"	1 4/5"	\$3.96
S-90 W1	85 - 91	3 3/8"-3 9/16"	4/5"	1/50"	1 4/5"	\$3.96
S-95 W1	90 - 96	3 9/16"-3 3/4"	4/5"	1/50"	1 4/5"	\$4.05
S-100 W1	95 - 101	3 3/4"-4"	4/5"	1/50"	1 4/5"	\$4.14
S-105 W1	100 - 106	3 15/16"-4 3/16"	4/5"	1/50"	1 4/5"	\$4.32
S-110 W1	105 - 111	4 1/8"-4 3/8"	4/5"	1/50"	1 4/5"	\$4.41
S-115 W1	110 - 116	4 5/16"-4 9/16"	4/5"	1/50"	1 4/5"	\$4.50
S-120 W1	115 - 121	4 1/2"-4 3/4"	4/5"	1/50"	1 4/5"	\$4.59
S-125 W1	120 - 126	4 11/16"-4 15/16"	4/5"	1/50"	1 4/5"	\$4.68
S-130 W1	125 - 131	4 15/16"-5 1/8"	4/5"	1/50"	1 4/5"	\$4.86
S-135 W1	130 - 136	5 1/8"-5 5/16"	4/5"	1/50"	1 4/5"	\$4.86
S-140 W1	135 - 141	5 5/16"-5 9/16"	4/5"	1/50"	1 4/5"	\$4.95
S-145 W1	140 - 146	5 1/2"-5 3/4"	4/5"	1/50"	1 4/5"	\$5.04
S-150 W1	145 - 151	5 11/16"-5 15/16"	4/5"	1/50"	1 4/5"	\$5.04

STAINLESS STEEL AISI 304 (W4)

MODEL	SIZE	BOLT	BAND-WIDTH	BAND THICKNESS	LENGTH	LIST PRICE
S-35 W4	30 - 36	1 3/16"-1 7/16"	4/5"	1/50"	1 4/5"	\$8.10
S-40 W4	35 - 41	1 3/8"-1 5/8"	4/5"	1/50"	1 4/5"	\$8.28
S-45 W4	40 - 46	1 9/16"-1 13/16"	4/5"	1/50"	1 4/5"	\$8.46
S-50 W4	45 - 51	1 3/4"-2"	4/5"	1/50"	1 4/5"	\$8.55
S-55 W4	50 - 56	2"-2 3/16"	4/5"	1/50"	1 4/5"	\$8.91
S-60 W4	55 - 61	2 3/16"-2 3/8"	4/5"	1/50"	1 4/5"	\$9.18
S-65 W4	60 - 66	2 3/8"-2 5/8"	4/5"	1/50"	1 4/5"	\$9.27
S-70 W4	65 - 71	2 9/16"-2 13/16"	4/5"	1/50"	1 4/5"	\$9.63

MODEL	SIZE	BOLT	BAND-WIDTH	BAND THICKNESS	LENGTH	LIST PRICE
S-75 W4	70 - 76	2 3/4"-3"	4/5"	1/50"	1 4/5"	\$9.81
S-80 W4	75 - 76	2 15/16"-3 3/16"	4/5"	1/50"	1 4/5"	\$9.99
S-85 W4	80 - 86	3 1/8"-3 3/8"	4/5"	1/50"	1 4/5"	\$9.99
S-90 W4	85 - 91	3 3/8"-3 9/16"	4/5"	1/50"	1 4/5"	\$10.26
S-95 W4	90 - 96	3 9/16"-3 3/4"	4/5"	1/50"	1 4/5"	\$10.62
S-100 W4	95 - 101	3 3/4"-4"	4/5"	1/50"	1 4/5"	\$10.80
S-105 W4	100 - 106	3 15/16"-4 3/16"	4/5"	1/50"	1 4/5"	\$10.98
S-110 W4	105 - 111	4 1/8"-4 3/8"	4/5"	1/50"	1 4/5"	\$11.43
S-115 W4	110 - 116	4 5/16"-4 9/16"	4/5"	1/50"	1 4/5"	\$11.61
S-120 W4	115 - 121	4 1/2"-4 3/4"	4/5"	1/50"	1 4/5"	\$11.88
S-125 W4	120 - 126	4 11/16"-4 15/16"	4/5"	1/50"	1 4/5"	\$12.24
S-130 W4	125 - 131	4 15/16"-5 1/8"	4/5"	1/50"	1 4/5"	\$12.51
S-135 W4	130 - 136	5 1/8"-5 5/16"	4/5"	1/50"	1 4/5"	\$12.69
S-140 W4	135 - 141	5 5/16"-5 9/16"	4/5"	1/50"	1 4/5"	\$12.87
S-145 W4	140 - 146	5 1/2"-5 3/4"	4/5"	1/50"	1 4/5"	\$13.05
S-150 W4	145 - 151	5 11/16"-5 15/16"	4/5"	1/50"	1 4/5"	\$13.14

STAINLESS STEEL AISI 316 (W5)

MODEL	SIZE	BOLT	BAND-WIDTH	BAND THICKNESS	LENGTH	LIST PRICE
S-35 W5	30 - 36	1 3/16"-1 7/16"	4/5"	1/50"	1 4/5"	\$9.70
S-40 W5	35 - 41	1 3/8"-1 5/8"	4/5"	1/50"	1 4/5"	\$12.15
S-45 W5	40 - 46	1 9/16"-1 13/16"	4/5"	1/50"	1 4/5"	\$12.51
S-50 W5	45 - 51	1 3/4"-2"	4/5"	1/50"	1 4/5"	\$12.69
S-55 W5	50 - 56	2"-2 3/16"	4/5"	1/50"	1 4/5"	\$13.05
S-60 W5	55 - 61	2 3/16"-2 3/8"	4/5"	1/50"	1 4/5"	\$13.32
S-65 W5	60 - 66	2 3/8"-2 5/8"	4/5"	1/50"	1 4/5"	\$13.77
S-70 W5	65 - 71	2 9/16"-2 13/16"	4/5"	1/50"	1 4/5"	\$14.04
S-75 W5	70 - 76	2 3/4"-3"	4/5"	1/50"	1 4/5"	\$14.67
S-80 W5	75 - 76	2 15/16"-3 3/16"	4/5"	1/50"	1 4/5"	\$15.03
S-85 W5	80 - 86	3 1/8"-3 3/8"	4/5"	1/50"	1 4/5"	\$15.30
S-90 W5	85 - 91	3 3/8"-3 9/16"	4/5"	1/50"	1 4/5"	\$15.57
S-95 W5	90 - 96	3 9/16"-3 3/4"	4/5"	1/50"	1 4/5"	\$15.93
S-100 W5	95 - 101	3 3/4"-4"	4/5"	1/50"	1 4/5"	\$16.56
S-105 W5	100 - 106	3 15/16"-4 3/16"	4/5"	1/50"	1 4/5"	\$17.10
S-110 W5	105 - 111	4 1/8"-4 3/8"	4/5"	1/50"	1 4/5"	\$17.73
S-115 W5	110 - 116	4 5/16"-4 9/16"	4/5"	1/50"	1 4/5"	\$18.09
S-120 W5	115 - 121	4 1/2"-4 3/4"	4/5"	1/50"	1 4/5"	\$18.36
S-125 W5	120 - 126	4 11/16"-4 15/16"	4/5"	1/50"	1 4/5"	\$18.63
S-130 W5	125 - 131	4 15/16"-5 1/8"	4/5"	1/50"	1 4/5"	\$18.99
S-135 W5	130 - 136	5 1/8"-5 5/16"	4/5"	1/50"	1 4/5"	\$19.26
S-140 W5	135 - 141	5 5/16"-5 9/16"	4/5"	1/50"	1 4/5"	\$19.62
S-145 W5	140 - 146	5 1/2"-5 3/4"	4/5"	1/50"	1 4/5"	\$20.16
S-150 W5	145 - 151	5 11/16"-5 15/16"	4/5"	1/50"	1 4/5"	\$20.79



Superex Clamps

SUPEREXTRA DOUBLE BOLT CLAMP

Construction: Bolt: Socket head grade 8.8. Available in Galvanized Steel, Stainless Steel AISI 304 and AISI 316.

Feature: Heavy duty clamp having double screws providing it a high clamping force. Clamp has a double band making it a very strong heavy duty clamp. Contains 2 bridges welded onto the clamp band for optimal hose protection. Contains 2 pairs of solid metal rollers which complement the strength of the double band. The double bolts allow for easy fitting on prefixed hoses. Socket head screws allow for easy installation with allen key.

Application: Ideal for applications where higher pressure and greater strength is required. Main applications are heavy vehicles and industrial machinery. Availability of clamp in AISI 316 make it popular for use in marine and offshore applications.

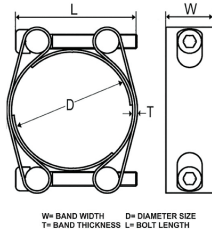

Double Bolt Clamp

GALVANIZED STEEL (W1)

MODEL	SIZE	BOLT	BANDWIDTH	LIST PRICE
SD-50 W1	41 - 51	1 5/8"-2"	4/5"	\$8.45
SD-55 W1	46 - 56	1 13/16"-2 3/16"	4/5"	\$8.55
SD-60 W1	51 - 61	2"-2 3/8"	4/5"	\$8.65
SD-65 W1	56 - 66	2 3/16"-2 9/16"	4/5"	\$5.40
SD-70 W1	61 - 71	2 3/8"-2 13/16"	4/5"	\$8.85
SD-75 W1	66 - 76	2 9/16"-3"	4/5"	\$5.67
SD-80 W1	71 - 81	2 13/16"-3 3/16"	4/5"	\$5.76
SD-85 W1	76 - 86	3"-3 3/8"	4/5"	\$5.85
SD-90 W1	81 - 91	3 3/16"-3 9/16"	4/5"	\$6.03
SD-95 W1	86 - 96	3 3/8"-3 3/4"	4/5"	\$6.12
SD-100 W1	91 - 101	3 9/16"-4"	4/5"	\$6.21
SD-105 W1	96 - 106	3 13/16"-4 3/16"	4/5"	\$6.39
SD-110 W1	101 - 111	4"-4 3/8"	4/5"	\$6.48
SD-115 W1	106 - 116	4 3/16"-4 9/16"	4/5"	\$6.57
SD-120 W1	111 - 121	4 3/8"-4 3/4"	4/5"	\$6.75
SD-125 W1	116 - 126	4 9/16"-4 15/16"	4/5"	\$6.84
SD-130 W1	121 - 131	4 3/4"-5 1/8"	4/5"	\$6.93
SD-135 W1	126 - 136	4 15/16"-5 5/16"	4/5"	\$7.11
SD-140 W1	131 - 141	5 1/8"-5 9/16"	4/5"	\$7.20
SD-145 W1	136 - 146	5 5/16"-5 3/4"	4/5"	\$7.38
SD-150 W1	141 - 151	5 9/16"-5 15/16"	4/5"	\$7.47
SD-155 W1	146 - 156	5 3/4"-6 1/8"	4/5"	\$7.56
SD-160 W1	151 - 161	5 15/16"-6 5/16"	4/5"	\$7.56
SD-165 W1	156 - 166	6 1/8"-6 9/16"	4/5"	\$7.74
SD-170 W1	161 - 171	6 5/16"-6 3/4"	4/5"	\$7.83
SD-175 W1	166 - 176	6 9/16"-6 15/16"	4/5"	\$7.92
SD-180 W1	171 - 181	6 3/4"-7 1/8"	4/5"	\$7.92

STAINLESS STEEL AISI 304 (W4)

MODEL	SIZE	BOLT	BANDWIDTH	LIST PRICE
SD-50 W4	41 - 51	1 5/8"-2"	4/5"	\$13.68
SD-55 W4	46 - 56	1 13/16"-2 3/16"	4/5"	\$14.85
SD-60 W4	51 - 61	2"-2 3/8"	4/5"	\$15.03
SD-65 W4	56 - 66	2 3/16"-2 9/16"	4/5"	\$15.30
SD-70 W4	61 - 71	2 3/8"-2 13/16"	4/5"	\$15.39
SD-75 W4	66 - 76	2 9/16"-3"	4/5"	\$15.57
SD-80 W4	71 - 81	2 13/16"-3 3/16"	4/5"	\$16.20
SD-85 W4	76 - 86	3"-3 3/8"	4/5"	\$16.56

MODEL	SIZE	BOLT	BANDWIDTH	LIST PRICE
SD-90 W4	81 - 91	3 3/16"-3 9/16"	4/5"	\$16.74
SD-95 W4	86 - 96	3 3/8"-3 3/4"	4/5"	\$17.01
SD-100 W4	91 - 101	3 9/16"-4"	4/5"	\$17.28
SD-105 W4	96 - 106	3 13/16"-4 3/16"	4/5"	\$17.55
SD-110 W4	101 - 111	4"-4 3/8"	4/5"	\$17.82
SD-115 W4	106 - 116	4 3/16"-4 9/16"	4/5"	\$18.18
SD-120 W4	111 - 121	4 3/8"-4 3/4"	4/5"	\$30.00
SD-125 W4	116 - 126	4 9/16"-4 15/16"	4/5"	\$30.15
SD-130 W4	121 - 131	4 3/4"-5 1/8"	4/5"	\$12.69
SD-135 W4	126 - 136	4 15/16"-5 5/16"	4/5"	\$18.99
SD-140 W4	131 - 141	5 1/8"-5 9/16"	4/5"	\$19.62
SD-145 W4	136 - 146	5 5/16"-5 3/4"	4/5"	\$20.16
SD-150 W4	141 - 151	5 9/16"-5 15/16"	4/5"	\$20.34
SD-155 W4	146 - 156	5 3/4"-6 1/8"	4/5"	\$20.43
SD-160 W4	151 - 161	5 15/16"-6 5/16"	4/5"	\$20.52
SD-165 W4	156 - 166	6 1/8"-6 9/16"	4/5"	\$20.79
SD-170 W4	161 - 171	6 5/16"-6 3/4"	4/5"	\$21.15
SD-175 W4	166 - 176	6 9/16"-6 15/16"	4/5"	\$21.42
SD-180 W4	171 - 181	6 3/4"-7 1/8"	4/5"	\$21.69

STAINLESS STEEL AISI 316 (W5)

MODEL	SIZE	BOLT	BANDWIDTH	LIST PRICE
SD-50 W5	41 - 51	1 5/8"-2"	4/5"	\$22.05
SD-55 W5	46 - 56	1 13/16"-2 3/16"	4/5"	\$21.60
SD-60 W5	51 - 61	2"-2 3/8"	4/5"	\$22.32
SD-65 W5	56 - 66	2 3/16"-2 9/16"	4/5"	\$22.50
SD-70 W5	61 - 71	2 3/8"-2 13/16"	4/5"	\$22.95
SD-75 W5	66 - 76	2 9/16"-3"	4/5"	\$23.22
SD-80 W5	71 - 81	2 13/16"-3 3/16"	4/5"	\$24.48
SD-85 W5	76 - 86	3"-3 3/8"	4/5"	\$24.75
SD-90 W5	81 - 91	3 3/16"-3 9/16"	4/5"	\$25.11
SD-95 W5	86 - 96	3 3/8"-3 3/4"	4/5"	\$25.74
SD-100 W5	91 - 101	3 9/16"-4"	4/5"	\$26.28
SD-105 W5	96 - 106	3 13/16"-4 3/16"	4/5"	\$26.91
SD-110 W5	101 - 111	4"-4 3/8"	4/5"	\$27.54
SD-115 W5	106 - 116	4 3/16"-4 9/16"	4/5"	\$28.17
SD-120 W5	111 - 121	4 3/8"-4 3/4"	4/5"	\$28.80
SD-125 W5	116 - 126	4 9/16"-4 15/16"	4/5"	\$29.07
SD-130 W5	121 - 131	4 3/4"-5 1/8"	4/5"	\$29.34
SD-135 W5	126 - 136	4 15/16"-5 5/16"	4/5"	\$29.70
SD-140 W5	131 - 141	5 1/8"-5 9/16"	4/5"	\$30.60
SD-145 W5	136 - 146	5 5/16"-5 3/4"	4/5"	\$31.23
SD-150 W5	141 - 151	5 9/16"-5 15/16"	4/5"	\$31.50
SD-155 W5	146 - 156	5 3/4"-6 1/8"	4/5"	\$51.00
SD-160 W5	151 - 161	5 15/16"-6 5/16"	4/5"	\$32.13
SD-165 W5	156 - 166	6 1/8"-6 9/16"	4/5"	\$32.40
SD-170 W5	161 - 171	6 5/16"-6 3/4"	4/5"	\$33.03
SD-175 W5	166 - 176	6 9/16"-6 15/16"	4/5"	\$33.39
SD-180 W5	171 - 181	6 3/4"-7 1/8"	4/5"	\$33.66



Superex Clamps

SUPEREXTRA DOUBLE BOLT CLAMP

Construction: Bolt: Socket head grade 8.8. Available in Galvanized Steel.

Feature: Heavy duty clamp having double screws providing it a high clamping force. Clamp has a double band making it a very strong heavy duty clamp. Contains 2 bridges welded onto the clamp band for optimal hose protection. Contains 2 pairs of solid metal rollers which complement the strength of the double band. The double bolts allow for easy fitting on prefixed hoses. Socket head screws allow for easy installation with allen key.

Application: Ideal for applications where higher pressure and greater strength is required. Main applications are heavy vehicles and industrial machinery.

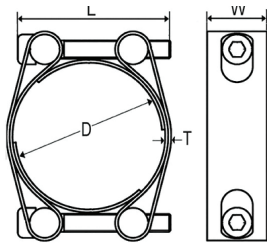

W= BAND WIDTH D= DIAMETER SIZE
T= BAND THICKNESS L= BOLT LENGTH



Double Bolt Clamp

SPIRAL CLAMP

Construction: Available in Trivalent Plating. Available for clockwise and anti clockwise spirals.

Feature: Total 360 degree vacuum seal. Single clamp provides adequate Torque to replace 2 conventional clamps on spiral hoses. Clamp is reusable; often referred to as a lifetime heavy duty clamp.

Application: Ideal for convoluted hoses used in fluid and chemical transfer, food and syrup handling, water suction and discharge, vacuum lines, slurry handling, etc.



Spiral Clamp

GALVANIZED STEEL (W1)

MODEL	SIZE	BOLT	BANDWIDTH	LIST PRICE
D-70 W1	61 - 71	2 3/8"-2 13/16"	49/50"	\$7.83
D-75 W1	66 - 76	2 5/8"-3"	49/50"	\$7.92
D-80 W1	71 - 81	2 13/16"-3 3/16"	49/50"	\$8.10
D-85 W1	76 - 86	3"-3 3/8"	49/50"	\$8.10
D-90 W1	81 - 91	3 3/16"-3 9/16"	49/50"	\$8.28
D-95 W1	86 - 96	3 3/8"-3 3/4"	49/50"	\$8.37
D-100 W1	91 - 101	3 9/16"-4"	49/50"	\$8.55
D-105 W1	96 - 106	3 13/16"-4 3/16"	49/50"	\$8.64
D-110 W1	101 - 111	4"-4 3/8"	49/50"	\$8.82
D-115 W1	106 - 116	4 3/16"-4 9/16"	49/50"	\$8.91
D-120 W1	111 - 121	4 3/8"-4 3/4"	49/50"	\$9.09
D-125 W1	116 - 126	4 9/16"-4 15/16"	49/50"	\$9.18
D-130 W1	121 - 131	4 3/4"-5 1/8"	49/50"	\$9.27
D-135 W1	126 - 136	4 15/16"-5 3/8"	49/50"	\$9.36
D-140 W1	131 - 141	5 1/8"-5 9/16"	49/50"	\$9.45
D-145 W1	136 - 146	5 3/8"-5 3/4"	49/50"	\$9.81
D-150 W1	141 - 151	5 9/16"-5 15/16"	49/50"	\$9.90
D-155 W1	146 - 156	5 3/4"-6 1/8"	49/50"	\$9.99
D-160 W1	151 - 161	5 15/16"-6 5/16"	49/50"	\$10.08
D-165 W1	156 - 166	6 1/8"-6 9/16"	49/50"	\$10.26
D-170 W1	161 - 171	6 5/16"-6 3/4"	49/50"	\$10.44
D-175 W1	166 - 176	6 9/16"-6 15/16"	49/50"	\$10.53
D-180 W1	171 - 181	6 3/4"-7 1/8"	49/50"	\$10.62
D-185 W1	176 - 186	6 15/16"-7 5/16"	49/50"	\$10.62
D-190 W1	181 - 191	7 1/8"-7 1/2"	49/50"	\$10.71
D-195 W1	186 - 196	7 5/16"-7 11/16"	49/50"	\$10.80
D-200 W1	191 - 201	7 1/2"-7 15/16"	49/50"	\$10.80
D-210 W1	201 - 211	7 15/16"-8 5/16"	49/50"	\$10.89
D-220 W1	211 - 221	8 5/16"-8 11/16"	49/50"	\$10.98
D-230 W1	221 - 231	8 11/16"-9 1/16"	49/50"	\$10.98

TRIVALENT PLATING

MODEL	SIZE	FITS HOSE	LIST PRICE
PC-37C	37 - 50	1 1/2"	\$10.89
PC-50C	50 - 65	2"	\$12.51
PC-65C	65 - 75	2 1/2"	\$15.57
PC-75C	75 - 90	3"	\$18.72
PC-100C	100 - 115	4"	\$24.93
PC-125C	125 - 143	5"	\$27.45
PC-150C	150 - 167	6"	\$37.44
PC-200C	200 - 230	8"	\$49.95
PC-250C	250 - 285	10"	\$62.46
PC-300C	300 - 340	12"	



Superex Clamps

WHIPCHECK

A pressurized air hose in case of hose failure or accidental uncoupling could cause the hose assembly to whip violently due to the sudden release of energy. This could make the whipping hose lethal and create a potentially dangerous situation. In such a scenario Superex whipchecks ensure safety from injury and property damage. Whipchecks are safety cables made to corrosion resistant, high strength steel, which on installation divert strain from the coupling to the whipcheck. Installation of whipchecks is easy and requires no tools- the spring loaded loops of the whipchecks are opened and slipped over each hose providing a firm grip on the hose and avoiding it from whipping in case of accidents.

Application: Whipchecks are commonly used on hose for air, water blast, drilling, steam, concrete, sandblast or other high pressure applications.



Whipcheck

HOSE TO HOSE

MODEL	WIRE DIAMETER (IN)	FITS HOSES (IN)	LIST PRICE
WH3	1/8"	1/2" to 1 1/4"	\$6.75
WH5	3/16"	1/2" to 2"	\$16.83
WH6	1/4"	1 1/2" to 3"	\$18.36
WH10	3/8"	4"	\$73.44

HOSE TO TOOL

MODEL	WIRE DIAMETER (IN)	FITS HOSES (IN)	LIST PRICE
WT3	1/8"	1/2" to 1 1/4"	\$6.12
WT5	3/16"	1/2" to 2"	\$15.30
WT6	1/4"	1 1/2" to 3"	\$16.83

This catalog cancels all previous ones and can be modified without notice. AR North America, Inc. preserves the right to carry out partial shipments. Characteristics and descriptions are not binding



**ANNOVI[®]
REVERBERI**
The Power of Experience



**NORTH[®]
AMERICA**
When Quality Matters

AR North America Inc.

140 - 81st Avenue Northeast

Fridley, MN USA 55432

Ph. +1 763 398 2008

Fax +1 763 398 2009

info@arnorthamerica.com

www.arnorthamerica.com
