

# RETAIL PRICING 2024



**MICRO-TRAK**<sup>®</sup>  
INNOVATIVE FROM THE GROUND UP



**MICRO-TRAK**<sup>®</sup>  
INNOVATIVE FROM THE GROUND UP

800.328.9613

Toll-Free Sales and Service - U.S.A. and Canada

Phone 507.257.3600

[www.micro-trak.com](http://www.micro-trak.com)

[trakmail@micro-trak.com](mailto:trakmail@micro-trak.com)

1305 Stadium Road

Mankato, MN 56001-5355

**PRICING EFFECTIVE SEPT. 1, 2023**

All pricing and specifications subject to change without notice.

All prices shown in U.S. dollars.

**WHAT SETS US APART:**

We partner, listen and customize solutions

Industry leading 3-year warranty

Loaner component support program

Flexible manufacturing for low to high volume needs

**NON-CANCELABLE /**

**NON RETURNABLE PARTS:**

Items designated with the asterisk \* sign in the product description are non-cancelable and non-returnable parts ("NCNR"). NCNR Parts are considered "Special Order" and may have longer than usual lead times. Orders for NCNR items cannot be canceled or returned for any reason other than the applicable warranty.

**NET PRICE ONLY ITEMS:**

Items designated as "Net Price Only" will be billed at the shown price - not subject to discount. Net Price Only is noted in the section description where applicable, and by "net" designation next to price.

# CONTENTS

Micro-Trak® pricing and product specifications are subject to change without notice. Access retail pricing in the Reseller area of the Micro-Trak® website - located in the Resources menu.

[micro-trak.com/resources/reseller-area](http://micro-trak.com/resources/reseller-area)



## ABBREVIATION KEY:

MP = Metri-Pack

WP = Weather Pack

LF = low flow

SS = stainless steel

GFN = glass filled nylon

PP = polypropylene

HDPE = high-density polyethylene

FKM = fluoroelastomer

## Systems

Monitors	4
Manual Controllers	6
Batch Controllers	7
Blockage Monitors	8
Automatic Rate Controllers	17
Customized Rate Controllers	19
ISOBUS Auto Rate Controller	33
Orchard/Vineyard Rate Controllers	36
Anti-Icing Rate Controllers	38
Granular Rate Controllers	41
Lift-N-Go™	42
Planting & Seeding Rate Controllers	43
NH3 Application Equipment	44
DirectConnect™ Kits	48

## Accessories

Speed Sensors	50
Flowmeters	50
Flow Control	50
Run/Hold Sensor Kits	51
Relay Kits	51
RPM Sensor Kits	51
Pressure Sensors	51
Bin Level Sensor	51
ISOBUS Tap Cables	52
Extension Cables	52

## Replacement Parts

Monitors, Manual & Batch Controllers	55
Blockage Monitors	55
Auto Rate Controllers	56
Planting & Seeding Controllers	58
NH3 Application Equipment	59
DirectConnect™	60
Speed & Run/Hold	61
Flowmeters	62
Speed Sensors	61
Flow Control (Servos, Control Valves & Parts)	63
EMD Parts	63
Speed, Radar & Adapter Cables	64
Replacement Consoles & ISOmods	67
Manuals	67
Demonstration Displays	68
Discontinued System Parts	69

<b>Index by Part Number</b>	<b>72</b>
-----------------------------	-----------

# SYSTEMS

## MONITORS

### Calc-An-Acre™

01001 KIT: included w/ console

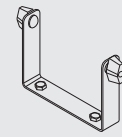
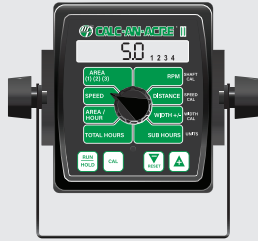

13181  
Console Mount Kit

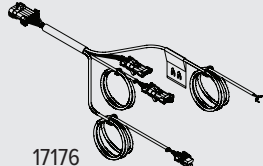

17176  
Power/Speed/Run-Hold/RPM  
Harness, 10'

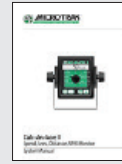

17192  
System Manual

### Calc-An-Acre™ - The Original Speed, Area, Distance and RPM Monitor

01001 Calc-An-Acre™ II Kit, (select speed sensor) \_\_\_\_\_ \$531.00

01000 Calc-An-Acre™ II Kit, w/ magnetic wheel sensor \_\_\_\_\_ \$615.00

#### Optional Items

01535 Run/Hold Sensor Kit, Hall-effect, w/ 2 magnets, 10' extension cable \_\_\_\_\_ \$211.24

01539 RPM Sensor Kit, RPM sensor, w/ mounting bracket, 2 magnets \_\_\_\_\_ \$141.93

18541 Run/Hold Sensor Kit, whisker switch, magnetic mount, 10' extension cable \_\_\_\_\_ \$366.57

18529 A Run/Hold Sensor Kit, whisker switch, (no magnetic mount) \_\_\_\_\_ \$294.92

#### Speed Sensors

01410 Astro™ II GPS Speed Sensor, 3-pin MP (1 Hz) \_\_\_\_\_ \$529.00

01425 Astro™ 5 GPS Speed Sensor, 3-pin MP (5 Hz) \_\_\_\_\_ \$707.00

01530 Wheel Speed Sensor Kit, Hall-effect Magnetic, w/ 10' extension cable, mounting bracket, 6 magnets \_\_\_\_\_ \$249.00

01533 Wheel Speed Sensor Kit, Hall-effect Magnetic, w/ mounting bracket, 6 magnets \_\_\_\_\_ \$136.00

01554 RPM Sensor Kit, proximity or gear tooth sensor, w/ 15' extension cable, mounting bracket \_\_\_\_\_ \$389.00

### Shaft-Trak™

01463 and 01323 KITS: included w/ console

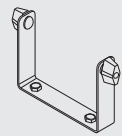

13181  
Console Mount Kit

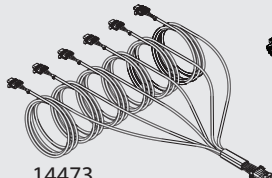

14473  
Sensor Harness, 7'

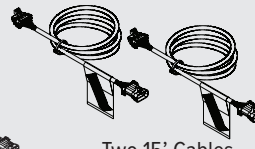

Two 15' Cables  
w/ Zip Ties



Instruction Sheet

### Shaft-Trak™ - Shaft and Bin Monitor

Shaft-Trak™ Low RPM (5 RPM with 1 Magnet) Recommended for Drill applications

01463 Shaft-Trak™ Low RPM Kit, w/o sensor kit \_\_\_\_\_ \$703.00

01464 Shaft-Trak™ Low RPM Kit, w/ 1 sensor kit \_\_\_\_\_ \$783.00

01465 Shaft-Trak™ Low RPM Kit, w/ 2 sensor kits \_\_\_\_\_ \$898.00

01466 Shaft-Trak™ Low RPM Kit, w/ 3 sensor kits \_\_\_\_\_ \$946.00

01467 Shaft-Trak™ Low RPM Kit, w/ 4 sensor kits \_\_\_\_\_ \$1,023.00

01468 Shaft-Trak™ Low RPM Kit, w/ 5 sensor kits \_\_\_\_\_ \$1,105.00

01469 Shaft-Trak™ Low RPM Kit, w/ 6 sensor kits \_\_\_\_\_ \$1,181.00

#### Shaft-Trak™ Standard (45 RPM with 1 Magnet)

01323 Shaft-Trak™ Kit, w/o shaft sensor kit \_\_\_\_\_ \$703.00

01330 Shaft-Trak™ Kit, w/ 1 shaft sensor \_\_\_\_\_ \$783.00

01331 Shaft-Trak™ Kit, w/ 2 shaft sensors \_\_\_\_\_ \$898.00

01332 Shaft-Trak™ Kit, w/ 3 shaft sensors \_\_\_\_\_ \$946.00

01333 Shaft-Trak™ Kit, w/ 4 shaft sensors \_\_\_\_\_ \$1,023.00

01334 Shaft-Trak™ Kit, w/ 5 shaft sensors \_\_\_\_\_ \$1,105.00

01335 Shaft-Trak™ Kit, w/ 6 shaft sensors \_\_\_\_\_ \$1,181.00

#### Optional Items

01544 Bin Level Sensor Kit, IR type sensor \_\_\_\_\_ \$165.00

01539 RPM Sensor Kit, RPM sensor, w/ mounting bracket, 2 magnets \_\_\_\_\_ \$141.93

**SodPro II™**

**01404 KIT: included w/ console**

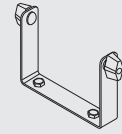

13181  
Console Mount Kit

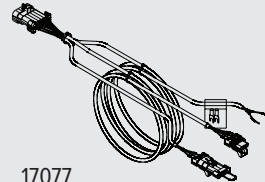

17077  
Main Harness, 10'



12910  
10 Zip Ties



17037  
Owner's Manual

**SodPro II™ - Sod Cutting Monitor**

01404 SodPro II™ Customized Kit, (select speed sensor) \_\_\_\_\_ \$828.00

**Optional Items**

01535 Run/Hold Sensor Kit, Hall-effect, w/ 2 magnets, 10' extension cable \_\_\_\_\_ \$211.24

18541 Run/Hold Sensor Kit, whisker switch, magnetic mount, 10' extension cable \_\_\_\_\_ \$366.57

18529 A Run/Hold Sensor Kit, whisker switch, (no magnetic mount) \_\_\_\_\_ \$294.92

**Speed Sensors**

01410 Astro™ II GPS Speed Sensor, 3-pin MP (1 Hz) \_\_\_\_\_ \$529.00

01425 Astro™ 5 GPS Speed Sensor, 3-pin MP (5 Hz) \_\_\_\_\_ \$707.00

01530 Wheel Speed Sensor Kit, Hall-effect Magnetic, w/ 10' extension cable, mounting bracket, 6 magnets \_\_\_\_\_ \$249.00

01533 Wheel Speed Sensor Kit, Hall-effect Magnetic, w/ mounting bracket, 6 magnets \_\_\_\_\_ \$136.00

01554 RPM Sensor Kit, proximity or gear tooth sensor, w/ 15' extension cable, mounting bracket \_\_\_\_\_ \$389.00

**Flow-Trak™ II**

**01021 KIT: included w/ console**

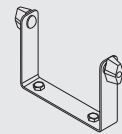

13181  
Console Mount Kit

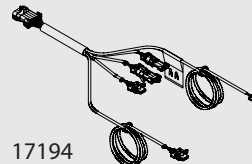

17194  
Power/Speed/Flow/RH/Opt  
Harness, 10'



17193  
Owner's Manual

**Flow-Trak™ II - Sprayer Monitor**

01021 Flow-Trak™ II Customized Kit, (select speed sensor and flowmeter kits) \_\_\_\_\_ \$917.00

01020 Flow-Trak™ II Kit, w/ FM750 GFN flowmeter and magnetic wheel sensor \_\_\_\_\_ \$1,680.00

01170 Flow-Trak™ II Kit, w/ FM750 GFN flowmeter, (select speed sensor) \_\_\_\_\_ \$1,438.00

**Optional Items**

01535 Run/Hold Sensor Kit, Hall-effect, w/ 2 magnets, 10' extension cable \_\_\_\_\_ \$211.24

17200 Relay Kit, Flow-Trak™ II \_\_\_\_\_ \$187.54

18541 Run/Hold Sensor Kit, whisker switch, magnetic mount, 10' extension cable \_\_\_\_\_ \$366.57

18529 A Run/Hold Sensor Kit, whisker switch, (no magnetic mount) \_\_\_\_\_ \$294.92

**Speed Sensors**

01410 Astro™ II GPS Speed Sensor, 3-pin MP (1 Hz) \_\_\_\_\_ \$529.00

01425 Astro™ 5 GPS Speed Sensor, 3-pin MP (5 Hz) \_\_\_\_\_ \$707.00

01531 Wheel Speed Sensor Kit, Hall-effect Magnetic, w/ 15' extension cable, mounting bracket, 6 magnets \_\_\_\_\_ \$270.00

01533 Wheel Speed Sensor Kit, Hall-effect Magnetic, w/ mounting bracket, magnets \_\_\_\_\_ \$136.00

01554 RPM Sensor Kit, proximity or gear tooth sensor, w/ 15' extension cable, mounting bracket \_\_\_\_\_ \$389.00

Flowmeter Kits (See page 7)

**FlowMate™**

**01739 KIT: included w/ console**



- 11837 Velcro
- 13207 Extension Cable, 15'
- 13209 Extension Cable, 25'
- 18155 Power Cable, 10'
- 50346 Instruction Sheet

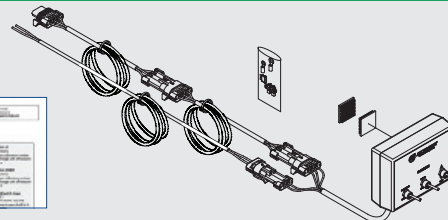

**FlowMate™ - Flow Monitor**

01740 FlowMate™ Kit, w/ FM750 GFN LF \_\_\_\_\_ \$1,164.00

01741 FlowMate™ Kit, w/ FM750 GFN \_\_\_\_\_ \$1,041.00

01739 FlowMate™ Customized Kit, (select flowmeter kit) \_\_\_\_\_ \$524.00

Flowmeter Kits (See page 7)

# MANUAL CONTROLLERS

## MC-10 Manual Controller (10 amp)

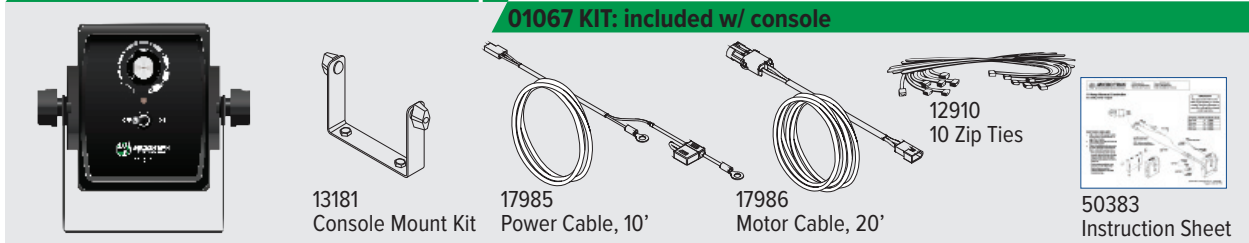

### MC-10 Manual Controller (10 amp)

01067 MC-10 Manual Controller Kit \_\_\_\_\_ \$325.00

#### Optional Items

01535 Run/Hold Sensor Kit, Hall-effect, w/ 2 magnets, 10' extension cable \_\_\_\_\_ \$211.24

#### Extension Cables

11560 Extension Cable, 2-pin WP, 5' \_\_\_\_\_ \$58.67

11561 Extension Cable, 2-pin WP, 10' \_\_\_\_\_ \$68.15

11671 Extension Cable, 2-pin WP, 15' \_\_\_\_\_ \$74.14

11672 Extension Cable, 2-pin WP, 20' \_\_\_\_\_ \$75.72

## MC-25 Manual Controller (25 amp)

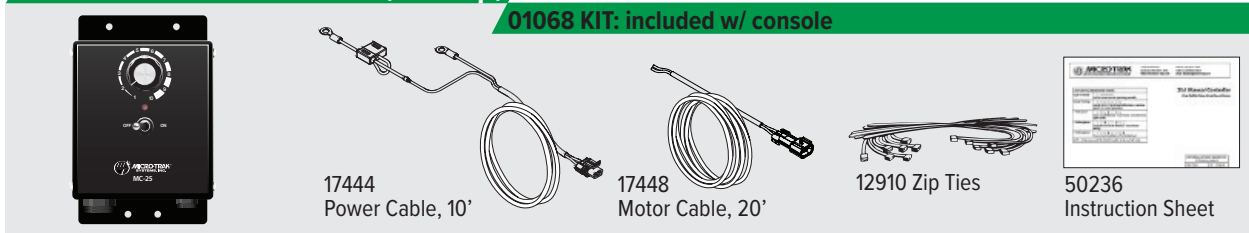

### MC-25 Manual Controller (25 amp)

01068 MC-25 Manual Controller Kit \_\_\_\_\_ \$619.00

#### Optional Items

18985 Pressure Gauge Bracket, MC-10, (Deep Back, No Gauge) \_\_\_\_\_ \$69.07

14799 Pressure Gauge Bracket for MC-25, (gauge not included) \_\_\_\_\_ \$38.00

#### Extension Cables

17501 Y Cable, 2 Pin MP 280, 1 Shroud & 2 towers, 20', (25 Amp MC dual motor) \_\_\_\_\_ \$122.75

17445 Extension Cable, 2-pin MP 280, 10' \_\_\_\_\_ \$123.05

17446 Extension Cable, 2-pin MP 280, 20' \_\_\_\_\_ \$193.32

18288 Extension Cable, 2-pin MP 280, 5' \_\_\_\_\_ \$87.82

18289 Extension Cable, 2-pin MP 280, 15' \_\_\_\_\_ \$158.25

18290 Extension Cable, 2-pin MP 280, 25' \_\_\_\_\_ \$228.54

**3 YEAR  
WARRANTY  
LIFETIME  
SERVICE**

# BATCH CONTROLLERS

Flo-Pro™

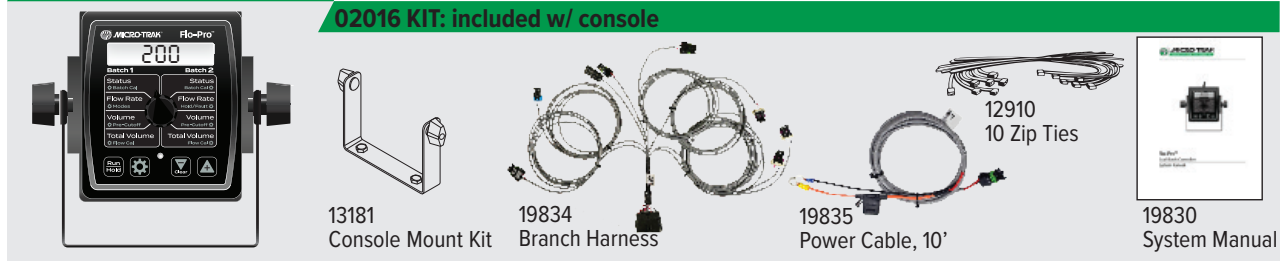

## Flo-Pro™

### Dual Channel Liquid Batch Controller

02016 Flo-Pro™ Customized Kit, includes 10' branch harness, 10' power cable \_\_\_\_\_ \$1,240.00

### Optional Items

19877 Flo-Pro™ Relay Kit, 15 Amp max \_\_\_\_\_ \$248.00

### Flowmeter Kits

#### Turbine Type Flowmeter Kits

01984	FM250 P Flowmeter Kit, .08-1.6 GPM, 290 PSI, 1/4" NPT and 1/2" HB, IXEF & SS _____	\$661.00
01500	FM500 Flowmeter Kit, .5-5 GPM, 500 PSI, 1/2" FPT, PP & Hastelloy _____	\$520.00
01501	FM750 GFN Flowmeter Kit, 2-40 GPM, 150 PSI, 3/4" FPT, nylon & Hastelloy _____	\$520.00
01504	FM750 SS Flowmeter Kit, 2-40 GPM, 500 PSI, 3/4" FPT, SS & nylon & Hastelloy _____	\$936.00
01507	FM750 SS Flowmeter Kit, w/ ceramic bearings, 2-40 GPM, 500 PSI, 3/4" FPT _____	\$936.00
01851	FM750 LF SS Flowmeter Kit, 1-9 GPM, 500 PSI, 3/4" FPT, SS & nylon & Hastelloy _____	\$1,059.00
01650	FM750 GFN LF Flowmeter Kit, .5-12 GPM, 150 PSI, 3/4" FPT, nylon & Hastelloy _____	\$641.00
01505	FM1000 SS Flowmeter Kit, 3.5-70 GPM, 500 PSI, 1" FPT, SS & nylon & Hastelloy _____	\$1,015.00
01515	FM270 Flowmeter Kit, 3.5-70 GPM, 225 PSI, M200 flange, PP, SS, nylon & Hastelloy _____	\$852.00
01515-P A	FM270 P Flowmeter Kit, 3.5-70 GPM, 225 PSI, M200 flange, PP & nylon & Hastelloy _____	\$567.00
01898	FM270 LF Flowmeter Kit, .5-15 GPM, 225 PSI, M200 flange, PP, SS, & nylon & Hastelloy _____	\$914.00
01898-P A	FM270 P LF Flowmeter Kit, .5-15 GPM, 225 PSI, M200 flange, PP & nylon & Hastelloy _____	\$609.00
01514	FM10/100 Flowmeter Kit, 10-100 GPM, 225 PSI, M200 flange, SS, PP & nylon & Hastelloy _____	\$884.00
01514-P A	FM10/100 P Flowmeter Kit, 10-100 GPM, 225 PSI, M200 flange, PP & nylon & Hastelloy _____	\$588.00
01506	FM1500 SS Flowmeter Kit, 10-130 GPM, 500 PSI, 1 1/2" FPT, SS & nylon & Hastelloy _____	\$1,335.00
01506-P A	FM1500 P SS Flowmeter Kit, 10-130 GPM, 500 PSI, 1 1/2" FPT, PP & nylon & Hastelloy _____	\$1,007.00
01519	FM1500 SS LF Flowmeter Kit, 3.5-70 GPM, 500 PSI, 1 1/2" FPT, SS & nylon & Hastelloy _____	\$1,391.00
01519-P A	FM1500 P SS LF Flowmeter Kit, 3.5-70 GPM, 500 PSI, 1 1/2" FPT, PP & nylon & Hastelloy _____	\$1,047.00
01511	FM2000 P Flowmeter Kit, 19-198 GPM, 285 PSI, M200 flange, nylon & SS & ceramic _____	\$1,539.00
01513	FM3000 P Flowmeter Kit, 40-396 GPM, 285 PSI, 3" MPT, nylon & SS & ceramic _____	\$2,013.00

#### Electromagnetic Flowmeter Kits

01901	MM2 Flowmeter Kit, .08 to 1.6 GPM, 290 PSI, 3/4" FPT, PP & SS _____	\$2,148.00
01821	MM3 Flowmeter Kit, .13 to 2.6 GPM, 290 PSI, 3/4" FPT, PP & SS _____	\$2,148.00
01822	MM5 Flowmeter Kit, .3 to 5 GPM, 290 PSI, 3/4" FPT, PP & SS _____	\$2,148.00
01823	MM13 Flowmeter Kit, .6 to 13 GPM, 290 PSI, 3/4" FPT, PP & SS _____	\$2,148.00
01824	MM26 Flowmeter Kit, 1.3 to 26 GPM 290 PSI, 1" FPT, PP & SS _____	\$2,148.00
01825	MM53 Flowmeter Kit, 2.6 to 53 GPM, 290 PSI, 1" FPT, PP & SS _____	\$2,148.00
01826	MM106 Flowmeter Kit, 5 to 106 GPM, 290 PSI, 1 1/2" FPT, PP & SS _____	\$2,148.00
02015	MM106FL Flowmeter Kit, 5 to 106 GPM, 290 PSI, M220 flange, PP & SS _____	\$2,148.00
01827	MM158 Flowmeter Kit, 8 to 158 GPM, 290 PSI, 2" MPT, PP & SS _____	\$2,148.00
01749	MM238 Flowmeter Kit, 12 to 238 GPM, 290 PSI, 2" MPT, PP & SS _____	\$1,439.00
02086 A	MM528 Flowmeter Kit, 26.5 to 528 GPM, 145 PSI, 3" MPT, 3-pin MP-150 Connector, PP & SS _____	\$1,631.00

# SAFEGUARD™ BLOCKAGE MONITORS

Select from **A B C D E F G** to build custom systems

## **A** SafeGuard™ Controller

### SafeGuard™ ISOmod™

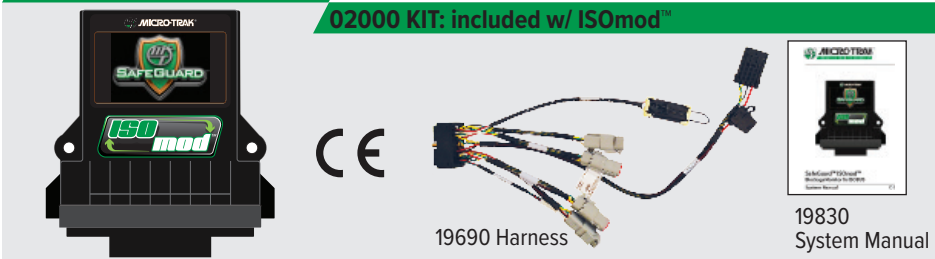

### SafeGuard™ ISOmod™

02000 SafeGuard™ ISOmod™ Kit, Amphenol conn. \_\_\_\_\_ \$1,405.00

### SafeGuard™ Console

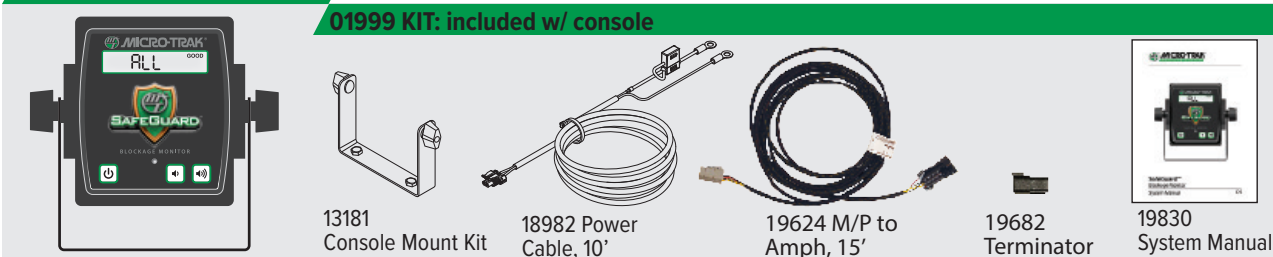

### SafeGuard™ Console

01999 SafeGuard™ Console Kit, Amphenol conn. \_\_\_\_\_ \$1,215.00

## **B** SafeGuard™ Sensor Kits

- 01994 Liquid Blockage Sensor, SafeGuard™, Amphenol, PVC, short leads \_\_\_\_\_ \$181.00
- 01995 Liquid Blockage Sensor, SafeGuard™, Amphenol, PVC, long leads \_\_\_\_\_ \$207.00
- 01997 Fumigant Blockage Sensor, SafeGuard™, Amphenol, Trogamid, long leads \_\_\_\_\_ \$241.00

## **C** IBIC Breakaway Implement Cable or ISOBUS Tap Cable Options

- 18921 IBIC Breakaway Implement Cable, no power connection, 10' \_\_\_\_\_ \$714.00
- 19700 C IBIC Breakaway Implement Cable, w/ power connection, 10' \_\_\_\_\_ \$833.00
- 15891 B IBIC Breakaway Implement Cable, w/ power connection, 30' \_\_\_\_\_ \$1,246.00
- 18894 ISOBUS Tap Cable, 6-pin MP 150 \_\_\_\_\_ \$255.00
- 18895 A ISOBUS Tap Cable, 12-pin Ampseal, John Deere® \_\_\_\_\_ \$255.00
- 18896 ISOBUS Tap Cable, 4-pin Delphi MP 630, Great Plains/Dickey JOHN® \_\_\_\_\_ \$255.00
- 18897 ISOBUS Tap Cable, 8-pin GT280, Case IH® \_\_\_\_\_ \$255.00
- 19857 ISOBUS Tap Cable Kit, w/ 6-pin MP150, 18894 and 18955 ECU power adapter cable \_\_\_\_\_ \$343.00
- 18955 Adapter Cable Kit, ECU power \_\_\_\_\_ \$160.00
- 16041 A ISOBUS Tap Cable, 12-pin Deutsch, Case IH® 2100 Series Planter \_\_\_\_\_ \$255.00
- 18944 Tap Cable (in-cab) Kit, w/ power cable, Deutsch DTM \_\_\_\_\_ \$255.00
- 18945 Tap Cable (in-cab) Kit, w/ power cable, Deutsch DT \_\_\_\_\_ \$343.00
- 18950 Tap Cable (in-cab) Kit, w/ power adapter, Deutsch DT \_\_\_\_\_ \$343.00
- 18967 Terminator Cable, w/TBC Plug, Deutsch DT \_\_\_\_\_ \$201.04
- 18968 Terminator Cable, w/TBC Plug, Deutsch DTM \_\_\_\_\_ \$223.00

### Extension Cable Options

- 19774 ISOBUS Extension Cable, 6-pin MP 150, 5' \_\_\_\_\_ \$212.15
- 19775 ISOBUS Extension Cable, 6-pin MP 150, 10' \_\_\_\_\_ \$232.68
- 19776 ISOBUS Extension Cable, 6-pin MP 150, 20' \_\_\_\_\_ \$273.63
- 19777 ISOBUS Extension Cable, 6-pin MP 150, 30' \_\_\_\_\_ \$314.71
- 19778 ISOBUS Extension Cable, 6-pin MP 150, 40' \_\_\_\_\_ \$355.79



*SafeGuard™ Blockage Monitors***Amphenol Extension Cables for SafeGuard™ Sensors**

19694 B	Extension Cable, 6-pin Amphenol twisted pair, 2.5'	\$75.06
19616 B	Extension Cable, 6-pin Amphenol twisted pair, 5'	\$92.73
19617 B	Extension Cable, 6-pin Amphenol twisted pair, 10'	\$126.58
19618 B	Extension Cable, 6-pin Amphenol twisted pair, 15'	\$161.15
19619 B	Extension Cable, 6-pin Amphenol twisted pair, 20'	\$195.73
19620 B	Extension Cable, 6-pin Amphenol twisted pair, 25'	\$230.32
19621 B	Extension Cable, 6-pin Amphenol twisted pair, 30'	\$264.91

**JWPF Extension Cables for SafeGuard™ Sensors (pre-2017)**

18525	Extension Cable, 6-pin MP150, w/ twisted pair, 15'	\$145.69
-------	--	----------

**D Implement Switch Options**

18541	Run/Hold Sensor Kit, whisker switch, magnetic mount, 10' extension cable	\$366.57
19625 A	Implement Switch Module, SafeGuard™, w/long Amphenol	\$308.47
01998	Run/Hold Sensor Kit, whisker switch, magnetic mount, includes 18541 and 19625	\$475.00

**E SafeGuard™ Sensor Cartridges (All Cartridges are Net Price Only)**

18687	Sensor Cartridge, SafeGuard™, PP, pink	\$4.13 NET
18688	Sensor Cartridge, SafeGuard™, HDPE, orange	\$4.13 NET
18511	Sensor Cartridge, SafeGuard™, HDPE, green	\$4.13 NET
18689	Sensor Cartridge, SafeGuard™, HDPE, yellow	\$4.13 NET
18691	Sensor Cartridge, SafeGuard™, HDPE, blue	\$4.13 NET
18692	Sensor Cartridge, SafeGuard™, HDPE, red	\$8.76 NET
18693	Sensor Cartridge, SafeGuard™, HDPE, brown	\$6.93 NET
18694	Sensor Cartridge, SafeGuard™, HDPE, grey	\$6.93 NET
18695	Sensor Cartridge, SafeGuard™, HDPE, white	\$10.78 NET
19060	Sensor Cartridge, SafeGuard™, HDPE, black, high range, fumigant compatible	\$4.13 NET
19928	Sensor Cartridge, SafeGuard™, HDPE, black, w/range extender, low range, fumigant compatible	\$11.92 NET

**F Sensor Fittings**

18489	Plug, PP, FKM (Viton® type) o-ring, no threads	\$7.29
18515	Plug, PP, FKM (Viton® type) o-ring, 1/4" FPT	\$7.29
18516	Plug, PP, FKM (Viton® type) o-ring, 3/8" FPT	\$7.29
18517	Plug, PP, FKM (Viton® type) o-ring, 3/4" FPT	\$7.29
18622	Plug, PP, FKM (Viton® type) o-ring, 3/4" straight hose barb	\$7.29
18623	Plug, PP, FKM (Viton® type) o-ring, 1" straight hose barb	\$7.29
18624	Plug, PP, FKM (Viton® type) o-ring, 3/8" hose barb w/ 90° elbow	\$7.29
18625	Plug, PP, FKM (Viton® type) o-ring, 1/2" hose barb w/ 90° elbow	\$7.29
18626	Plug, PP, FKM (Viton® type) o-ring, 1/4" John Guest w/90° elbow	\$16.11
18670	Plug, PP, FKM (Viton® type) o-ring, 5/16" John Guest w/ 90° elbow	\$17.58
18627	Plug, PP, FKM (Viton® type) o-ring, 3/8" John Guest w/ 90° elbow	\$16.48
18488	Cap, PP, w/ SS U-clip, no threads	\$7.29
18524	Cap, PP, w/ SS U-clip, 3/4" FPT	\$7.29
18620	Cap, PP, w/ SS U-clip, 3/4" straight hose barb	\$7.29
18621	Cap, PP, w/ SS U-clip, 1" straight hose barb	\$7.29
18493	Tee, PVC, w/ SS U-clip, FKM (Viton® type) o-ring	\$18.23
19017	Tee, PP, w/ SS U-clip, FKM (Viton® type) o-ring, fumigant compatible	\$18.23

  
**3 YEAR  
WARRANTY**  

---

**LIFETIME  
SERVICE**  

SafeGuard™ Blockage Monitors

**Replacement Parts**

19690 Harness, SafeGuard™ ISOmod™, w/ Amphenol \_\_\_\_\_ \$791.95

**Miscellaneous Sensor Parts**

18510 C U-clip, SS \_\_\_\_\_ \$2.34  
 18521 O-ring, FKM (Viton® type) \_\_\_\_\_ \$8.00  
 18963 O-ring, orifice plate \_\_\_\_\_ \$1.82  
 18514 Cartridge Retainer Clip \_\_\_\_\_ \$4.02  
 18653 SafeGuard™ Sensor Mounting Spacer \_\_\_\_\_ \$4.34  
 18721 SafeGuard™ Sensor Bracket \_\_\_\_\_ \$12.43  
 21993 Cartridge Range Extender \_\_\_\_\_ \$18.63  
 02011 Magnet Bar Mount, ISOmod™ \_\_\_\_\_ \$46.84

**Console to Hitch Cable Options**

19624 B Adapter, 6-pin, M/P150 to Amphenol twisted pair, 15' \_\_\_\_\_ \$145.68  
 19676 A Adapter, 6-pin, M/P150 to Amphenol twisted pair, 25' \_\_\_\_\_ \$212.25

**Terminators**

19681 A Terminator, 6-pin, Amphenol tower \_\_\_\_\_ \$31.30  
 19682 A Terminator, 6-pin, Amphenol shroud \_\_\_\_\_ \$22.15

**Pre-2017 Sensor Adapter Cables**

19837 A Adapter Cable, pre-2017 sensors, JWPF Tower to Amphenol Shroud \_\_\_\_\_ \$17.00 NET  
 19838 A Adapter Cable, pre-2017 sensors, JWPF Shroud to Amphenol Tower \_\_\_\_\_ \$17.00 NET

**Pre-2017 SafeGuard™ Parts**

18667 Dust Cover, 6-pin RCPTCL \_\_\_\_\_ \$12.14

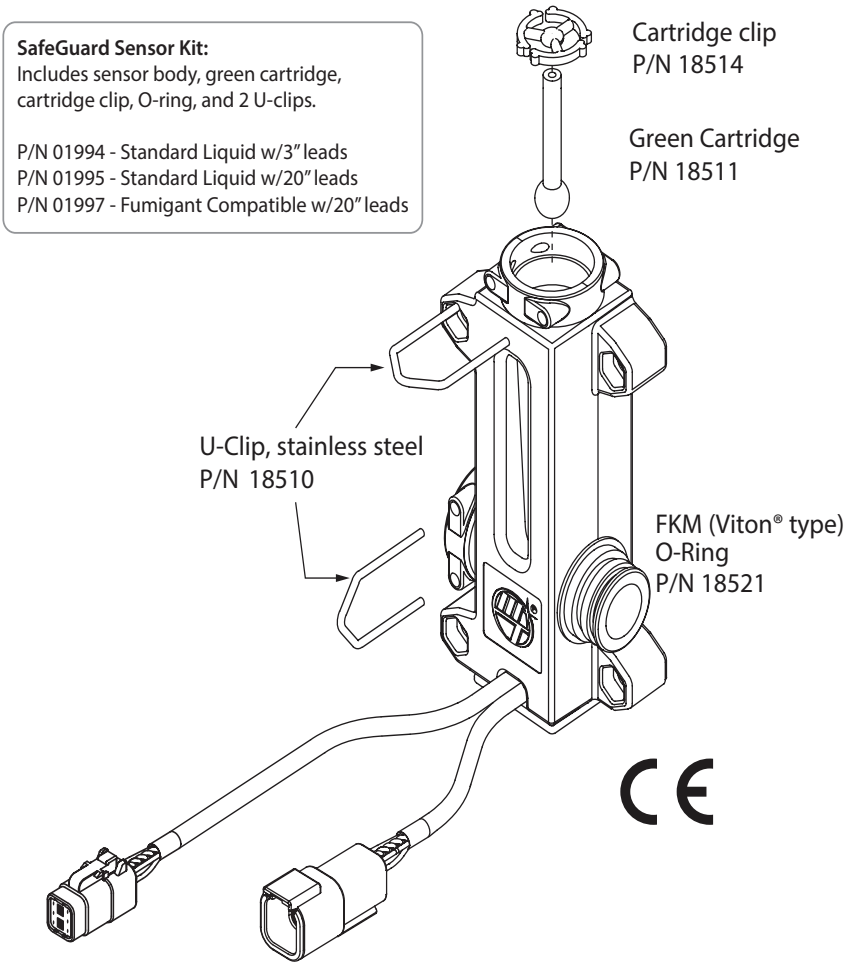

**Important Note:**  
 Effective Jan. 1 2017, SafeGuard™ sensor plugs changed from small JWPF to larger Amphenol. Be certain to check vintage prior to ordering repl. parts.

<p><b>Pre-2017</b>  <b>GRAY JWPF</b></p>	<p><b>2017-after</b>  <b>BLACK or GRAY</b>  <b>Amphenol</b></p>
--	---



# BLOCKAGE MONITOR

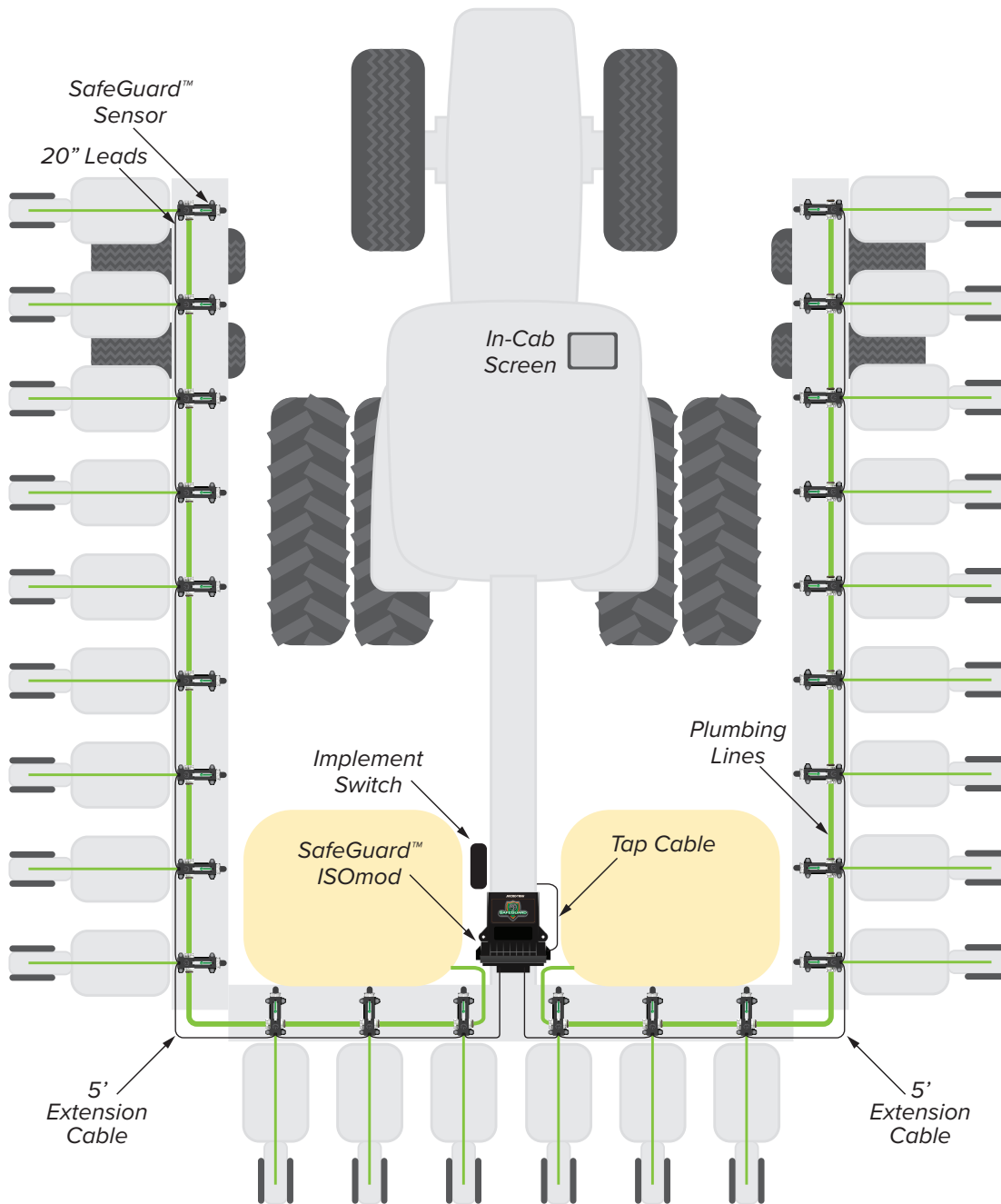

## 2024 Retail Pricing

### SafeGuard™ ISOmod™ Over-The-Row System

P/N	Description	Qty
02000	SafeGuard™ ISOmod™ Kit	1
18895	John Deere ISO Tab Cable	1
01995	SafeGuard™ Sensor Kit, 20" Leads*	24
18541	Implement Whisker Switch Kit	1
19616	Extension Cable, 5'	2

**24 ROW - LIST PRICE: \$8,008.98**

### Options

P/N	Description	Qty
18721	Sensor Brackets	24
18653	Mounting Spacers	48
19617	6-Pin Amphenol Extension Cable, 10'	1
19619	6-Pin Amphenol Extension Cable, 20'	1

\*Sensor Kits include Green Cartridges

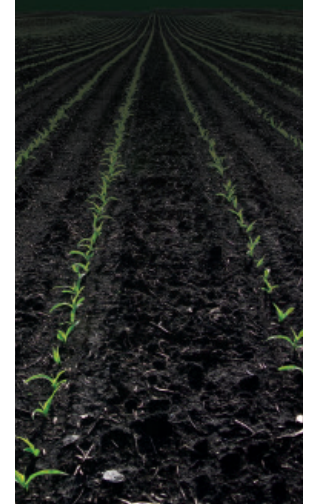



# BLOCKAGE MONITOR

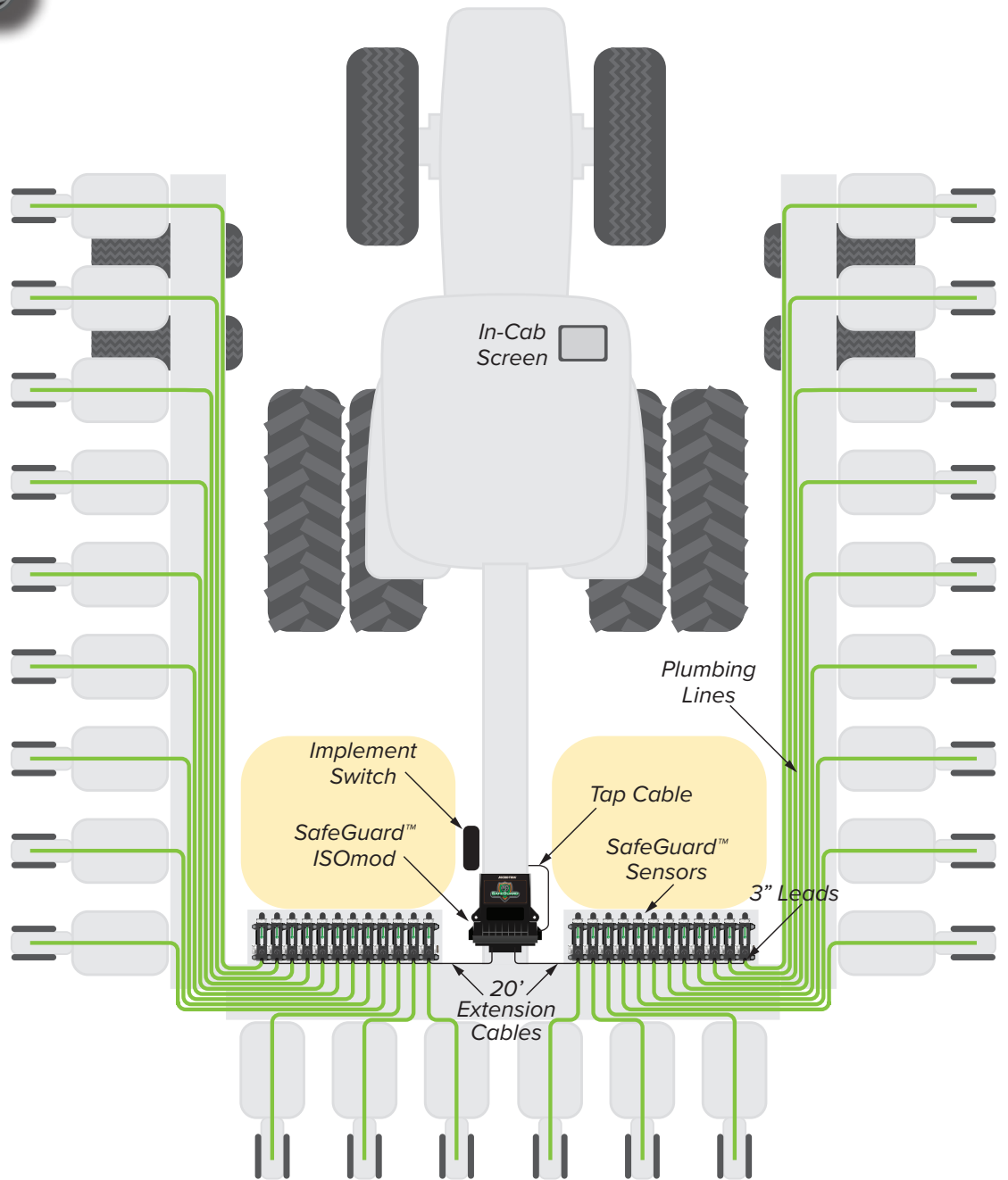

## 2024 Retail Pricing

### SafeGuard™ ISOmod™ Ganged System

P/N	Description	Qty
02000	SafeGuard™ ISOmod™ Kit	1
18895	John Deere ISO Tab Cable	1
01994	SafeGuard™ Sensor Kit, 3" Leads*	24
18541	Implement Whisker Switch Kit	1
19619	Extension Cable, 20'	2

### Options

P/N	Description	Qty
18721	Sensor Brackets	24
18653	Mounting Spacers	48

\*Sensor Kits include Green Cartridges

**24 ROW - LIST PRICE: \$7,268.67**



# BLOCKAGE MONITOR

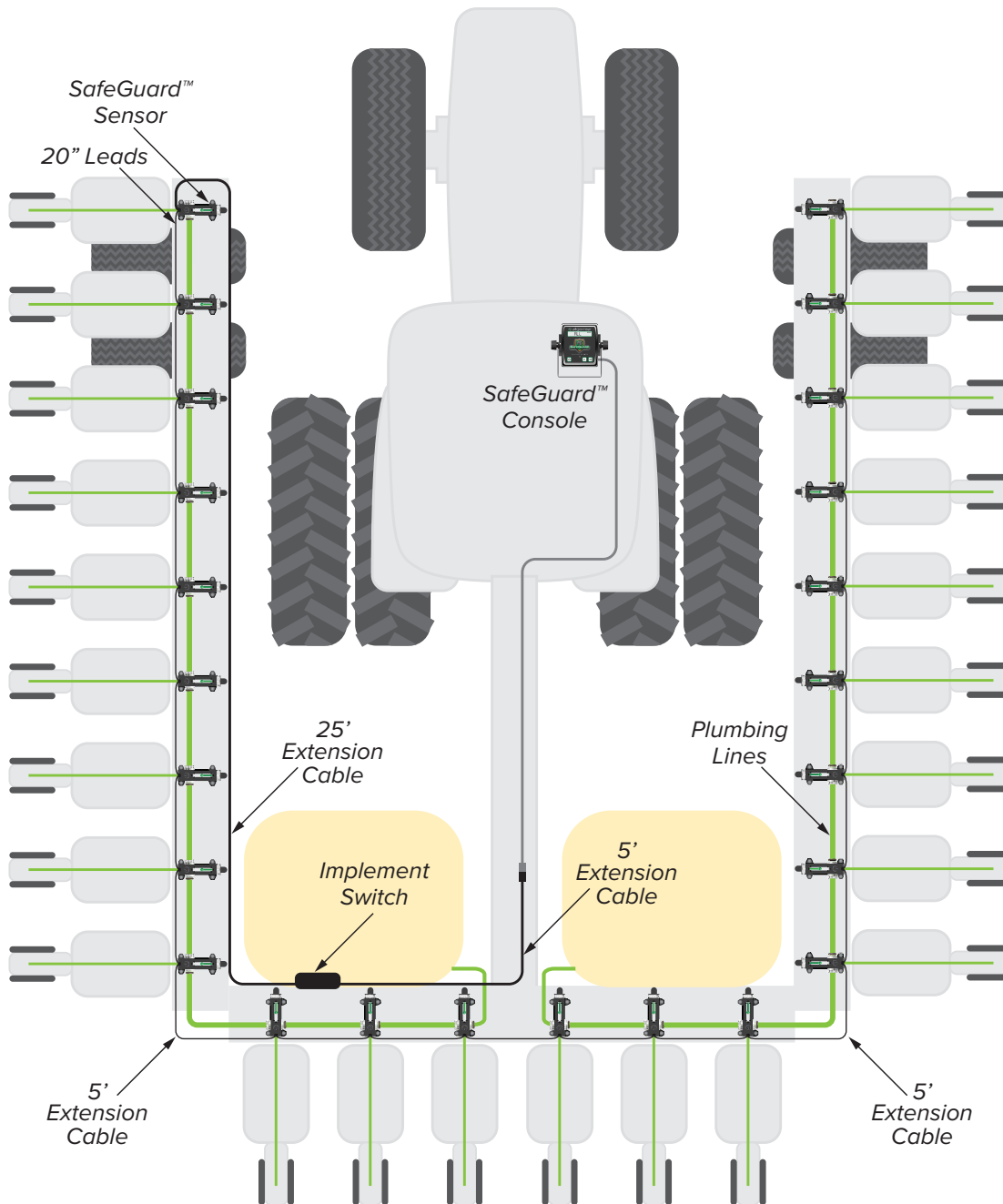

## 2024 Retail Pricing

### SafeGuard™ Console Over-The-Row System

P/N	Description	Qty
01999	SafeGuard™ Console Kit	1
01995	SafeGuard™ Sensor Kit, 20" Leads*	24
01998	Run/Hold Sensor Kit	1
19616	Extension Cable, 5'	3
19620	Extension Cable, 25'	1

**24 ROW - LIST PRICE: \$7,673.15**

### Options

P/N	Description	Qty
18721	Sensor Brackets	24
18653	Mounting Spacers	48

\*Sensor Kits include Green Cartridges

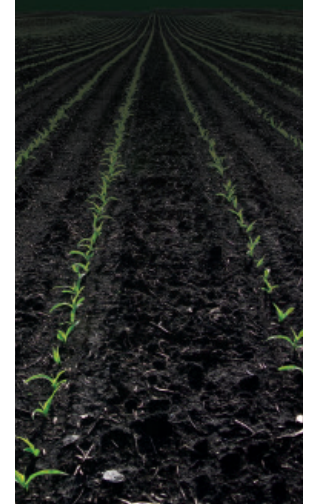



# BLOCKAGE MONITOR

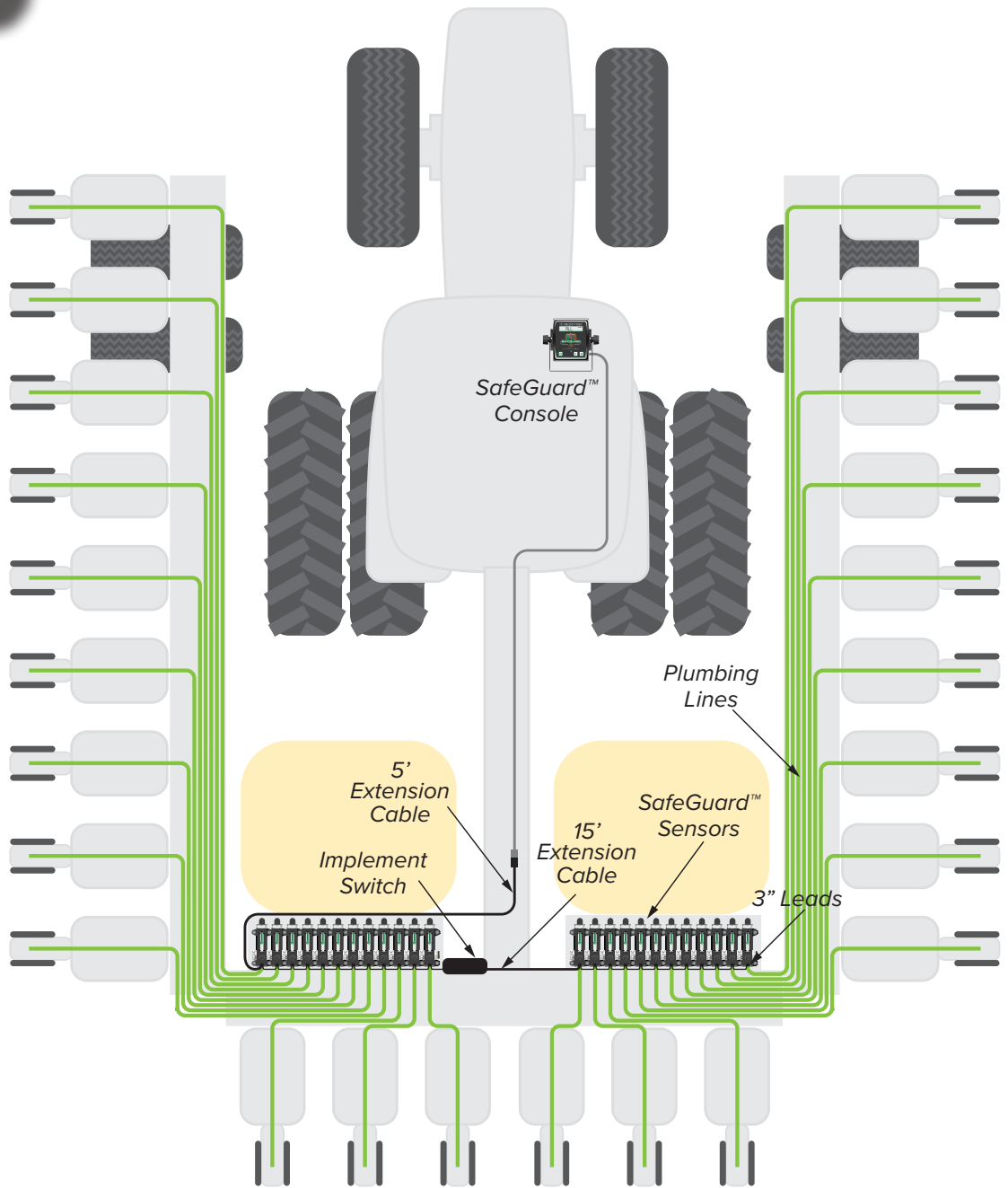

## 2024 Retail Pricing

### SafeGuard™ Console Ganged System

P/N	Description	Qty
01999	SafeGuard™ Console Kit	1
01994	SafeGuard™ Sensor Kit, 3" Leads*	24
01998	Run/Hold Sensor Kit	1
19616	Extension Cable, 5'	1
19618	Extension Cable, 15'	1

**24 ROW - LIST PRICE: \$6,794.52**

### Options

P/N	Description	Qty
18721	Sensor Brackets	24
18653	Mounting Spacers	48

\*Sensor Kits include Green Cartridges

# SAFEGUARD™ SENSOR FITTINGS



## BLOCKAGE MONITOR



**Plug**  
18489 No Threads



**Cap**  
18524 3/4" FPT



**Cap**  
18488 No Threads



**Plug**  
18515 1/4" FPT  
18516 3/8" FPT  
18517 3/4" FPT



**Plug**  
**Straight Hose Barb**  
18622 3/4"  
18623 1"



**Tee Fitting**  
18493 Liquid Rated  
19017 Fumigant Rated\*

\*Stainless Steel



**Plug**  
**Elbow Hose Barb**  
18624 3/8"  
18625 1/2"



**Cap**  
**Straight Hose Barb**  
18620 3/4"  
18621 1"



**Plug**  
**John Guest® Elbow**  
18626 1/4"  
18670 5/16"  
18627 3/8"

18489	Plug, PP, FKM (Viton® type) o-ring, no threads _____	\$7.29
18515	Plug, PP, FKM (Viton® type) o-ring, 1/4" FPT _____	\$7.29
18516	Plug, PP, FKM (Viton® type) o-ring, 3/8" FPT _____	\$7.29
18517	Plug, PP, FKM (Viton® type) o-ring, 3/4" FPT _____	\$7.29
18622	Plug, PP, FKM (Viton® type) o-ring, 3/4" straight hose barb _____	\$7.29
18623	Plug, PP, FKM (Viton® type) o-ring, 1" straight hose barb _____	\$7.29
18624	Plug, PP, FKM (Viton® type) o-ring, 3/8" hose barb w/ 90° elbow _____	\$7.29
18625	Plug, PP, FKM (Viton® type) o-ring, 1/2" hose barb w/ 90° elbow _____	\$7.29
18626	Plug, PP, FKM (Viton® type) o-ring, 1/4" John Guest w/90° elbow _____	\$16.11
18670	Plug, PP, FKM (Viton® type) o-ring, 5/16" John Guest w/ 90° elbow _____	\$17.58
18627	Plug, PP, FKM (Viton® type) o-ring, 3/8" John Guest w/ 90° elbow _____	\$16.48
18488	Cap, PP, w/ SS U-clip, no threads _____	\$7.29
18524	Cap, PP, w/ SS U-clip, 3/4" FPT _____	\$7.29
18620	Cap, PP, w/ SS U-clip, 3/4" straight hose barb _____	\$7.29
18621	Cap, PP, w/ SS U-clip, 1" straight hose barb _____	\$7.29
18493	Tee, PVC, w/ SS U-clip, FKM (Viton® type) o-ring _____	\$18.23
19017	Tee, PP, w/ SS U-clip, FKM (Viton® type) o-ring, fumigant compatible _____	\$18.23

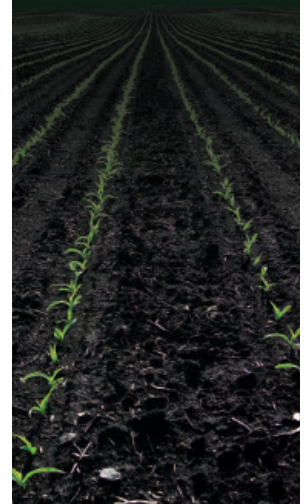



**Choosing the correct cartridge:**

1. Calculate your target "GOOD" flow rate in GPM or L/Min using the equation below:  
**Speed (MPH) X Rate (GPA) X Spacing (inches) / 5940**  
 or  
**Speed (KM/H) X Rate (L/HA) X Spacing (cm) / 60,000**  
 of the chart.
2. Find the calculated GPM or L/Min value on the left side of the chart.
3. Determine the density of the product you will be applying and find this value at the bottom of the chart.
4. The point of intersection is the optimal color cartridge. Any cartridge rated for lower flow rates will also work.

**Weight of water = 10.59 lb/gal (1.27 kg/l)**

**Example of weights of liquid fertilizers (approx):**

7-17-3 – 10.59 lb/gal (1.27 kg/l)

28-0-0 – 10.67 lb/gal (1.28 kg/l)

32-0-0 – 11.06 lb/gal (1.33 kg/l)

10-34-0 – 11.60 lb/gal (1.39 kg/l)

**Example Calculation:**

Applying 28-0-0 fertilizer  
 6 MPH speed  
 12 GPA rate  
 30" row spacing  
 $6 \times 12 \times 30 / 5940 = 0.37$  Gallons/Minute/Sensor  
 Find 0.37 on the left side of the graph.  
 Find 10.67 lb/gal for 28-0-0 on the bottom of the graph.  
 These intersect in the **YELLOW** area.

YELLOW is the optimal cartridge for this example. (GREEN and ORANGE will also work.)

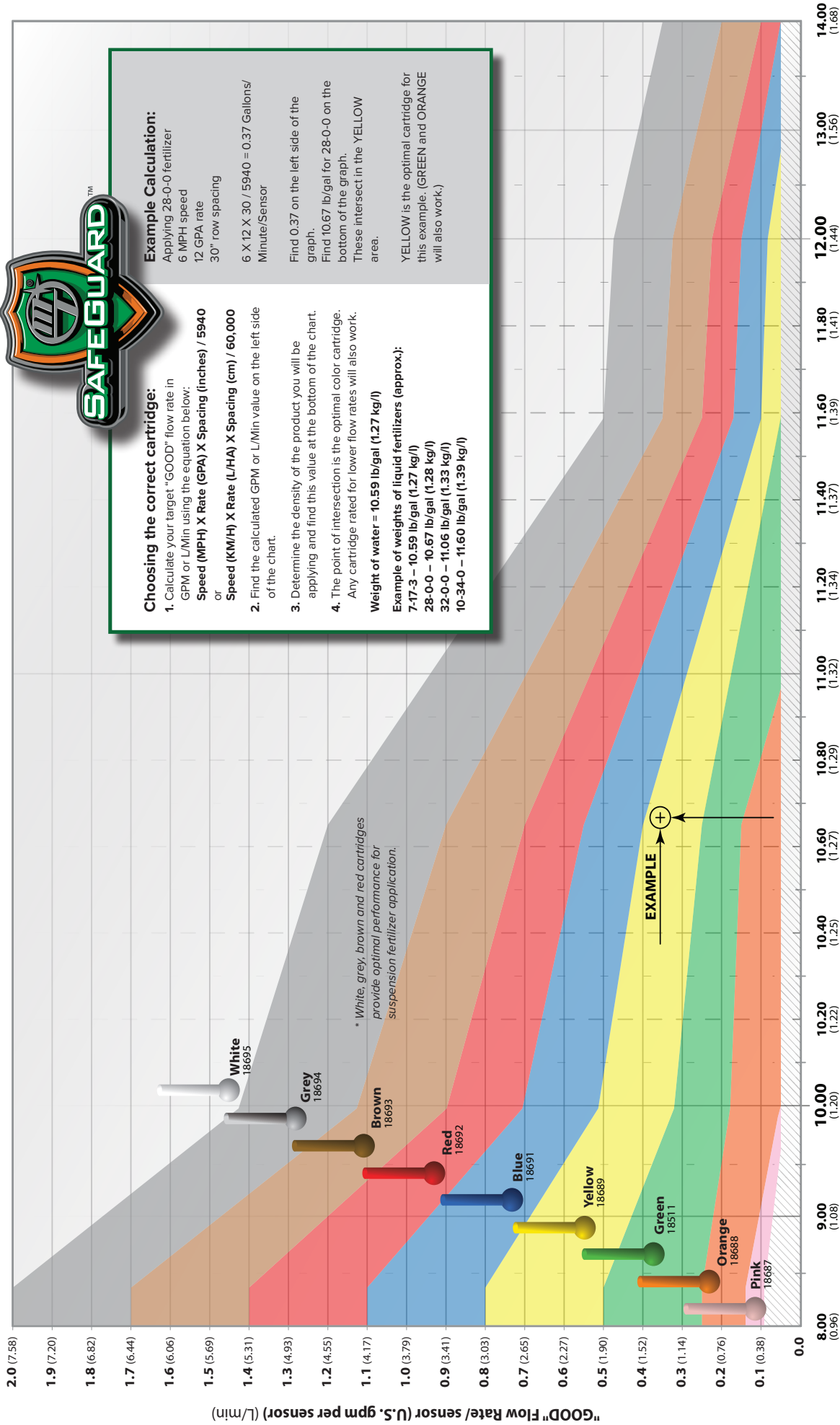





Density in lb/gal (pounds per U.S. gallon of material) (kg/L)

Range of Commonly Used Liquids



# AUTOMATIC RATE CONTROLLER KITS

## Automatic Rate Controller Product Guide

					
	SprayMate™ II	SprayMate™ Plus	RateKing™ Plus	RateKing™ Dual Plus	Dual ISOmod™
Channels	1	1	1	2	2
Section Outputs	3	3	3, 5 or 7	3, 5 or 7	12
Multifunction Outputs	-	1	2	2 per Channel	2 per Channel
PWM Output	-	Yes	Yes	Yes	Yes
Control Modes	Standard Servo	PWM or Standard Servo	PWM or Standard Servo	PWM or Standard Servo	PWM or Standard Servo
Flow Based Control	Yes	Yes	Yes	Yes	Yes
Pressure Based Control	-	Yes	Yes	Yes	Yes
Pressure Limit Alarm	-	Yes	Yes	Yes	Yes
Controllable Materials	Liquid or NH3	Liquid or NH3	Liquid or NH3	Liquid and/or NH3	Any Combination of Liquid, NH3 or Granular

### MT-2405™ II

**MT-2405™ II KIT: included w/ console**

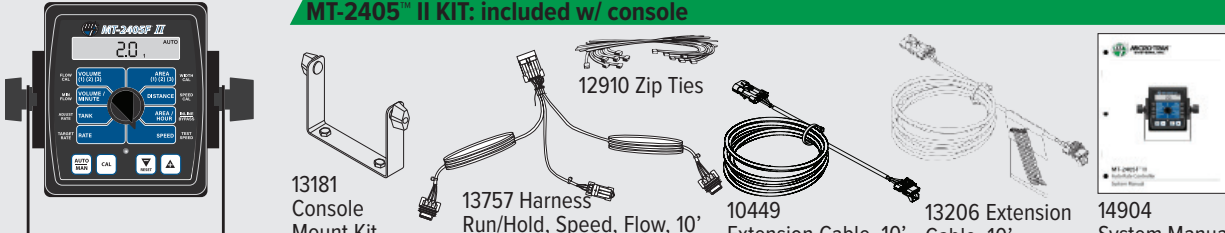

13181 Console Mount Kit

12910 Zip Ties

13757 Harness Run/Hold, Speed, Flow, 10'

10449 Extension Cable, 10'

13206 Extension Cable, 10'

14904 System Manual

### MT-2405™ II - Complete Kit:

01224 MT-2405 F™ II Kit, w/ FM750 GFN flowmeter, 1" servo valve, magnetic wheel sensor \_\_\_\_\_ \$2,007.00

**Optional Items (See page 18)**

### SprayMate™ II

**SprayMate™ II KIT: included w/ console**

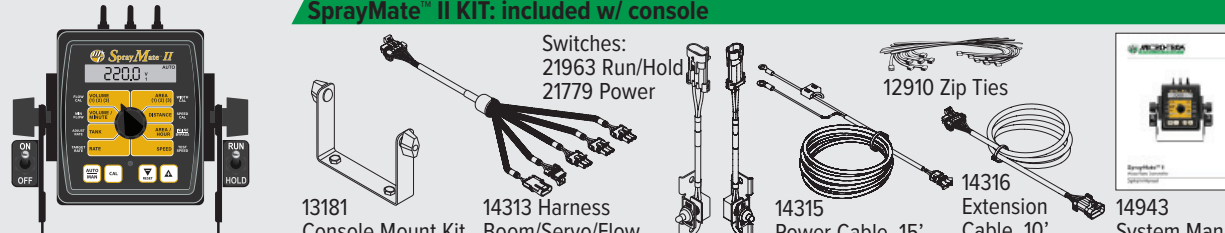

13181 Console Mount Kit

Switches:  
21963 Run/Hold  
21779 Power

12910 Zip Ties

14313 Harness Boom/Servo/Flow

14315 Power Cable, 15'

14316 Extension Cable, 10'

14943 System Manual

### SprayMate™ II - Complete Kits:

- 01196 SprayMate™ II Starter Fertilizer Kit, w/ FM750 LF, 40-amp EMD, (select speed sensor) \_\_\_\_\_ \$2,520.00
- 01974 SprayMate™ II Starter Fertilizer Kit, w/ FM750LF, 40-amp EMD, Astro™ II GPS Speed Sensor \_\_\_\_\_ \$3,031.00
- 01188 SprayMate™ II Starter Fertilizer Kit, w/ FM500, 40-amp EMD, (select speed sensor) \_\_\_\_\_ \$2,400.00
- 01973 SprayMate™ II Starter Fertilizer Kit, w/ FM500, 40-amp EMD, Astro™ II GPS Speed Sensor \_\_\_\_\_ \$2,913.00
- 01171 SprayMate™ II Kit, w/ FM750 GFN flowmeter, 1" servo valve (select speed sensor) \_\_\_\_\_ \$2,010.00
- 01340 SprayMate™ II Kit, w/ FM750 GFN flowmeter, 1" servo valve, magnetic wheel sensor \_\_\_\_\_ \$2,255.00
- 01972 SprayMate™ II Kit, w/ FM750 GFN flowmeter, 1" servo valve, Astro™ II GPS Speed Sensor \_\_\_\_\_ \$2,523.00

**Optional Items (See page 18)**

## SprayMate™ Plus

### SprayMate™ Plus KIT: included w/ console

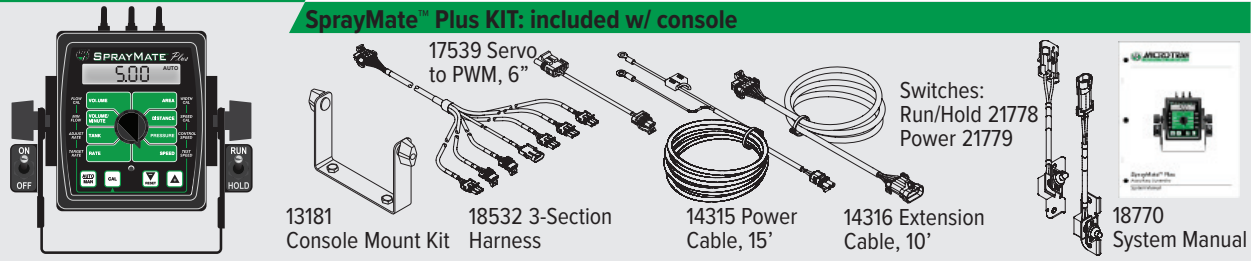

## SprayMate™ Plus - Complete Kits:

### Ready-to-Work Complete Kits:

01866	SprayMate™ Plus Kit, w/ FM 750 GFN, 1" servo valve, (select speed sensor)	\$2,514.00
01352	SprayMate™ Plus Kit, w/ FM750 GFN, 1" servo valve, magnetic speed sensor	\$2,751.00
01975	SprayMate™ Plus Kit, w/ FM 750 GFN flowmeter, 1" servo valve, Astro™ II GPS Speed Sensor	\$3,029.00
02026 A	SprayMate™ Plus Kit, w/Raven 440 adapter cable, CPC female connector	\$1,422.10
02038 A	SprayMate™ Plus Kit, w/Raven 440 adapter cable, CPC male (old style) connector	\$1,422.10
02054 A	SprayMate™ Plus Fertilizer Kit, w/ FM750 GFN LF, 40-amp PWM EMD, Astro II GPS Speed Sensor	\$3,582.00

### Optional Items (See below)

## RateKing™ Plus

### RateKing™ Plus KIT: included w/ console

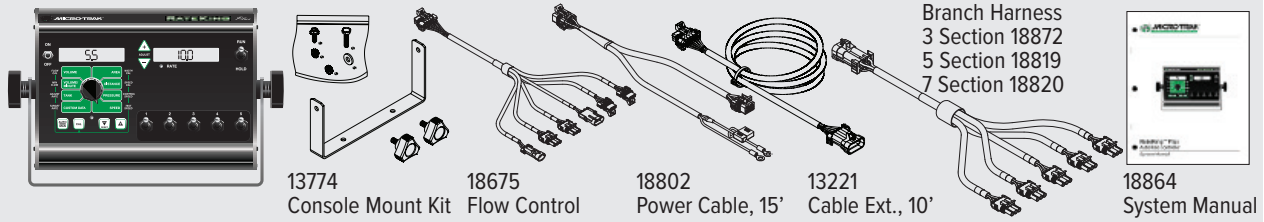

## RateKing™ Plus - Complete Kits:

01883	RateKing™ Plus Kit, 5 Section, w/ FM750 GFN, 1" servo valve, (select speed sensor)	\$2,818.00
01882	RateKing™ Plus Kit, 5 Section, w/ FM750 GFN, 1" servo valve, magnetic wheel sensor	\$3,063.00
01976	RateKing™ Plus Kit, 5 Section, w/ FM750 GFN, 1" servo valve, Astro™ II GPS Speed Sensor	\$3,329.00
01894	RateKing™ Plus Kit, 7 Section, w/ FM750 GFN, 1" servo valve, (select speed sensor)	\$3,170.00
01895	RateKing™ Plus Kit, 7 Section, w/ FM750 GFN, 1" servo valve, magnetic wheel sensor	\$3,412.00
01977	RateKing™ Plus Kit, 7 Section, w/ FM750 GFN, 1" servo valve, Astro™ II GPS Speed Sensor	\$3,683.00

### Optional Items (See below)

## Optional Items - Automatic Rate Controller Kits

18757	Pressure Sensor only, 150 PSI, 4 to 20mA	\$278.54
18758	Pressure Sensor only, 300 PSI, 4 to 20mA	\$278.54
18764	Pressure Harness Kit, single, w/ 15' sensor cable, 10' extension cable	\$149.32
18765	Pressure Harness Kit, dual, w/ 15' sensor cable, 10' extension cable	\$278.54
01554	RPM Sensor Kit, proximity or gear tooth sensor, w/ 15' extension cable, mounting bracket	\$389.00
18541	Run/Hold Sensor Kit, whisker switch, w/ magnetic mount, 10' extension cable	\$366.57
18529 A	Run/Hold Sensor Kit, whisker switch, (no magnetic mount)	\$294.92
01535	Run/Hold Sensor Kit, Hall-effect, w/ 2 magnets, 10' extension cable	\$211.24

## Optional Items-Plus Series Only

01781	Parallel Boom "Y" Cable Kit, RateKing™ Dual, 5 section	\$484.81
16032 A	Parallel Boom "Y" Cable Kit, RateKing™ Dual, 7 section	\$573.00

### (If ordering the 16032 Kit - add one of the following Section Branch Harnesses:)

18872	Section Branch Harness, 3 section WPT-PGS, 10'	\$249.16
18819	Section Branch Harness, 5 section WPT-PGS, 10'	\$285.39
18820	Section Branch Harness, 7 section WPT-PGS, 10'	\$326.74

# MT-2405™ II CUSTOMIZED RATE CONTROLLER

Select from **A B C D E** to build custom systems

## **A** Console with Main Harness

**MT-2405™ II**
**MT-2405™ II KIT: included w/ console**

The image shows the components included in the MT-2405™ II KIT: a console unit, 12910 Zip Ties, 13181 Console Mount Kit, 13757 Harness Run/Hold, Speed, Flow, 10', 10449 Extension Cable, 10', 13206 Extension Cable, 10', 13758 Harness Power/Servo, and 14904 System Manual.

01226 MT-2405 F™ II Customized Kit, (use with existing section switches) \_\_\_\_\_ \$850.00

## **B** Speed Sensors

- 01410 Astro™ II GPS Speed Sensor, 3-pin MP (1 Hz) \_\_\_\_\_ \$529.00
- 01425 Astro™ 5 GPS Speed Sensor, 3-pin MP (5 Hz) \_\_\_\_\_ \$707.00
- 01437 Astro™ 5 GPS Speed Sensor, 3-pin MP for Trak-Record II \_\_\_\_\_ \$754.00
- 01530 Wheel Speed Sensor Kit, Hall-effect Magnetic, w/ 10' extension cable, mounting bracket, 6 magnets \_ \$249.00
- 01531 Wheel Speed Sensor Kit, Hall-effect Magnetic, w/ 15' extension cable, mounting bracket, 6 magnets\_\_ \$270.00
- 01533 Wheel Speed Sensor Kit, Hall-effect Magnetic, w/ mounting bracket, 6 magnets \_\_\_\_\_ \$136.00
- 01554 RPM Sensor Kit, proximity or gear tooth sensor, w/ 15' extension cable, mounting bracket \_\_\_\_\_ \$389.00

## **C** Flowmeter Kits

### Turbine Type Flowmeter Kits

- 01984 FM250 P Flowmeter Kit, .08-1.6 GPM, 290 PSI, 1/4" NPT and 1/2" HB, IXEF & SS \_\_\_\_\_ \$661.00
- 01500 FM500 Flowmeter Kit, .5-5 GPM, 500 PSI, 1/2" FPT, PP & Hastelloy \_\_\_\_\_ \$520.00
- 01501 FM750 GFN Flowmeter Kit, 2-40 GPM, 150 PSI, 3/4" FPT, nylon & Hastelloy \_\_\_\_\_ \$520.00
- 01504 FM750 SS Flowmeter Kit, 2-40 GPM, 500 PSI, 3/4" FPT, SS & nylon & Hastelloy \_\_\_\_\_ \$936.00
- 01507 FM750 SS Flowmeter Kit, w/ ceramic bearings, 2-40 GPM, 500 PSI, 3/4" FPT \_\_\_\_\_ \$936.00
- 01851 FM750 LF SS Flowmeter Kit, 1-9 GPM, 500 PSI, 3/4" FPT, SS & nylon & Hastelloy \_\_\_\_\_ \$1,059.00
- 01650 FM750 GFN LF Flowmeter Kit, .5-12 GPM, 150 PSI, 3/4" FPT, nylon & Hastelloy \_\_\_\_\_ \$641.00
- 01505 FM1000 SS Flowmeter Kit, 3.5-70 GPM, 500 PSI, 1" FPT, SS & nylon & Hastelloy \_\_\_\_\_ \$1,015.00
- 01515 FM270 Flowmeter Kit, 3.5-70 GPM, 225 PSI, M200 flange, PP, SS, nylon & Hastelloy \_\_\_\_\_ \$852.00
- 01515-P A FM270 P Flowmeter Kit, 3.5-70 GPM, 225 PSI, M200 flange, PP & nylon & Hastelloy \_\_\_\_\_ \$567.00
- 01898 FM270 LF Flowmeter Kit, .5-15 GPM, 225 PSI, M200 flange, PP, SS, & nylon & Hastelloy \_\_\_\_\_ \$914.00
- 01898-P A FM270 P LF Flowmeter Kit, .5-15 GPM, 225 PSI, M200 flange, PP & nylon & Hastelloy \_\_\_\_\_ \$609.00
- 01514 FM10/100 Flowmeter Kit, 10-100 GPM, 225 PSI, M200 flange, SS, PP & nylon & Hastelloy \_\_\_\_\_ \$884.00
- 01514-P A FM10/100 P Flowmeter Kit, 10-100 GPM, 225 PSI, M200 flange, PP & nylon & Hastelloy \_\_\_\_\_ \$588.00
- 01506 FM1500 SS Flowmeter Kit, 10-130 GPM, 500 PSI, 1 1/2" FPT, SS & nylon & Hastelloy \_\_\_\_\_ \$1,335.00
- 01506-P A FM1500 P SS Flowmeter Kit, 10-130 GPM, 500 PSI, 1 1/2" FPT, PP & nylon & Hastelloy \_\_\_\_\_ \$1,007.00
- 01519 FM1500 SS LF Flowmeter Kit, 3.5-70 GPM, 500 PSI, 1 1/2" FPT, SS & nylon & Hastelloy \_\_\_\_\_ \$1,391.00
- 01519-P A FM1500 P SS LF Flowmeter Kit, 3.5-70 GPM, 500 PSI, 1 1/2" FPT, PP & nylon & Hastelloy \_\_\_\_\_ \$1,047.00
- 01511 FM2000 P Flowmeter Kit, 19-198 GPM, 285 PSI, M200 flange, nylon & SS & ceramic \_\_\_\_\_ \$1,539.00
- 01513 FM3000 P Flowmeter Kit, 40-396 GPM, 285 PSI, 3" MPT, nylon & SS & ceramic \_\_\_\_\_ \$2,013.00

### Electromagnetic Flowmeter Kits

- 01901 MM2 Flowmeter Kit, .08 to 1.6 GPM, 290 PSI, 3/4" FPT, PP & SS \_\_\_\_\_ \$2,148.00
- 01821 MM3 Flowmeter Kit, .13 to 2.6 GPM, 290 PSI, 3/4" FPT, PP & SS \_\_\_\_\_ \$2,148.00
- 01822 MM5 Flowmeter Kit, .3 to 5 GPM, 290 PSI, 3/4" FPT, PP & SS \_\_\_\_\_ \$2,148.00
- 01823 MM13 Flowmeter Kit, .6 to 13 GPM, 290 PSI, 3/4" FPT, PP & SS \_\_\_\_\_ \$2,148.00
- 01824 MM26 Flowmeter Kit, 1.3 to 26 GPM 290 PSI, 1" FPT, PP & SS \_\_\_\_\_ \$2,148.00
- 01825 MM53 Flowmeter Kit, 2.6 to 53 GPM, 290 PSI, 1" FPT, PP & SS \_\_\_\_\_ \$2,148.00
- 01826 MM106 Flowmeter Kit, 5 to 106 GPM, 290 PSI, 1 1/2" FPT, PP & SS \_\_\_\_\_ \$2,148.00
- 02015 MM106FL Flowmeter Kit, 5 to 106 GPM, 290 PSI, M220 flange, PP & SS \_\_\_\_\_ \$2,148.00
- 01827 MM158 Flowmeter Kit, 8 to 158 GPM, 290 PSI, 2" MPT, PP & SS \_\_\_\_\_ \$2,148.00
- 01749 MM238 Flowmeter Kit, 12 to 238 GPM, 290 PSI, 2" MPT, PP & SS \_\_\_\_\_ \$1,439.00
- 02086 A MM528 Flowmeter Kit, 26.5 to 528 GPM, 145 PSI, 3" MPT, 3-pin MP-150 Connector, PP & SS \_\_\_\_\_ \$1,631.00

**D Flow Control****Servo Valve (Butterfly) Kits**

19093	Servo Valve, 1" butterfly, Viton® o-rings, 150 PSI _____	\$429.00
19094	Servo Valve, 1" high pressure butterfly, Viton® o-rings, 300 PSI _____	\$499.00
19095	Servo Valve, 1" butterfly, aqueous ammonia, EPDM o-rings, 150 PSI _____	\$429.00
19096	Servo Valve, M200 flanged or 1 1/2" FPT, 1" butterfly, Viton® o-rings, 150 PSI _____	\$600.00
19097	Servo Valve, M200 flanged or 1 1/2" FPT, 1.5" butterfly, Viton® o-rings, 150 PSI, M200 _____	\$600.00
19098	Servo Valve, M200 flanged or 1 1/2" FPT, 1" butterfly, aqua ammonia, EPDM o-rings, 150 PSI ____	\$600.00
19099	Servo Valve, M200 flanged or 1 1/2" FPT, 1 1/2" butterfly, aqua ammonia, EPDM o-rings, 150 PSI _	\$600.00

**EMD - Electric Motor Driver Kits**

18008	Electric Motor Driver Kit, STD, 10 Amp _____	\$569.00
01757	Electric Motor Driver Kit, STD, 40 Amp _____	\$851.00

**Hydraulic Flow Control Valve Kits**

13859	Servo Type Hydraulic Flow Control Valve, 5 GPM, 3.5 Second, SAE 8 port, 3000 PSI _____	\$1,654.00
14885	Servo Type Hydraulic Flow Control Valve, 10 GPM, 3.5 Second, SAE 8 ports, 3000 PSI _____	\$1,654.00
13857	Servo Type Hydraulic Flow Control Valve, 15 GPM, 3.5 Second, SAE 8 ports, 3000 PSI _____	\$1,654.00
13860	Servo Type Hydraulic Flow Control Valve, 20 GPM, 3.5 Second, SAE 16 ports, 3000 PSI _____	\$2,715.00
13858	Servo Type Hydraulic Flow Control Valve, 35 GPM, 3.5 Second, SAE 16 ports, 3000 PSI _____	\$2,715.00

**Hydraulic Motor/Shutoff Valve Assemblies**

17576	Hydraulic Motor/Shutoff Valve Assembly, 4.9 CID, (no sprockets) _____	\$2,318.00
-------	---	------------

**E Optional Items**

01554	RPM Sensor Kit, proximity or gear tooth sensor, w/ 15' extension cable, mounting bracket _____	\$389.00
18541	Run/Hold Sensor Kit, whisker switch, w/ magnetic mount, 10' extension cable _____	\$366.57
18529 A	Run/Hold Sensor Kit, whisker switch, (no magnetic mount) _____	\$294.92

**MP (Metri-Pack) 150 Extension Cables**

13200	Extension Cable, 2-pin MP 150, 5' _____	\$74.21
13201	Extension Cable, 2-pin MP 150, 10' _____	\$80.11
13202	Extension Cable, 2-pin MP 150, 15' _____	\$86.60
13203	Extension Cable, 2-pin MP 150, 20' _____	\$90.39
13204	Extension Cable, 2-pin MP 150, 25' _____	\$97.80
13205	Extension Cable, 3-pin MP 150, 5' _____	\$82.01
13206	Extension Cable, 3-pin MP 150, 10' _____	\$87.55
13207	Extension Cable, 3-pin MP 150, 15' _____	\$98.43
13208	Extension Cable, 3-pin MP 150, 20' _____	\$104.69
13209	Extension Cable, 3-pin MP 150, 25' _____	\$111.73
13220	Extension Cable, 10-pin MP 150, 5' _____	\$142.53
13221	Extension Cable, 10-pin MP 150, 10' _____	\$170.20
13222	Extension Cable, 10-pin MP 150, 15' _____	\$194.62
13223	Extension Cable, 10-pin MP150, 20' _____	\$233.12
13224	Extension Cable, 10-pin MP 150, 25' _____	\$274.69

**WP (Weather Pack) Extension Cables**

10450	Extension Cable, 3-pin WP, 5' _____	\$76.53
10449	Extension Cable, 3-pin WP, 10' _____	\$85.79
10876	Extension Cable, 3-pin WP, 15' _____	\$97.81
10829	Extension Cable, 3-pin WP, 20' _____	\$108.24
11462	Extension Cable, 3-pin WP, 25' _____	\$118.46

**Replacement Parts**

13757	Branch Harness, speed, run/hold, MT-2405 F™ II and FTW II, 10' _____	\$231.96
13758	Branch Harness, boom, power, servo, MT-2405 F™ II and FTW II, 10' _____	\$199.11

# SPRAYMATE™ II CUSTOMIZED CONTROLLER

Select from **A B C D E** to build custom systems

## **A** Console with Main Harness

### SprayMate™ II

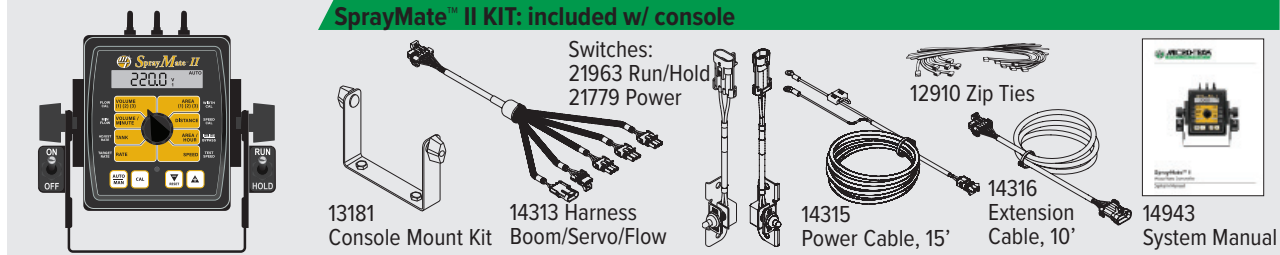

01341 SprayMate™ II Customized Kit, 3 section \_\_\_\_\_ \$1,076.00

## **B** Speed Sensors

- 01410 Astro™ II GPS Speed Sensor, 3-pin MP (1 Hz) \_\_\_\_\_ \$529.00
- 01425 Astro™ 5 GPS Speed Sensor, 3-pin MP (5 Hz) \_\_\_\_\_ \$707.00
- 01437 Astro™ 5 GPS Speed Sensor, 3-pin MP for Trak-Record II \_\_\_\_\_ \$754.00
- 01530 Wheel Speed Sensor Kit, Hall-effect Magnetic, w/ 10' extension cable, mounting bracket, 6 magnets \_ \$249.00
- 01531 Wheel Speed Sensor Kit, Hall-effect Magnetic, w/ 15' extension cable, mounting bracket, 6 magnets\_\_ \$270.00
- 01533 Wheel Speed Sensor Kit, Hall-effect Magnetic, w/ mounting bracket, 6 magnets \_\_\_\_\_ \$136.00
- 01554 RPM Sensor Kit, proximity or gear tooth sensor, w/ 15' extension cable, mounting bracket \_\_\_\_\_ \$389.00

## **C** Flowmeter Kits

### Turbine Type Flowmeter Kits

- 01984 FM250 P Flowmeter Kit, .08-1.6 GPM, 290 PSI, 1/4" NPT and 1/2" HB, IXEF & SS \_\_\_\_\_ \$661.00
- 01500 FM500 Flowmeter Kit, .5-5 GPM, 500 PSI, 1/2" FPT, PP & Hastelloy \_\_\_\_\_ \$520.00
- 01501 FM750 GFN Flowmeter Kit, 2-40 GPM, 150 PSI, 3/4" FPT, nylon & Hastelloy \_\_\_\_\_ \$520.00
- 01504 FM750 SS Flowmeter Kit, 2-40 GPM, 500 PSI, 3/4" FPT, SS & nylon & Hastelloy \_\_\_\_\_ \$936.00
- 01507 FM750 SS Flowmeter Kit, w/ ceramic bearings, 2-40 GPM, 500 PSI, 3/4" FPT \_\_\_\_\_ \$936.00
- 01851 FM750 LF SS Flowmeter Kit, 1-9 GPM, 500 PSI, 3/4" FPT, SS & nylon & Hastelloy \_\_\_\_\_ \$1,059.00
- 01650 FM750 GFN LF Flowmeter Kit, .5-12 GPM, 150 PSI, 3/4" FPT, nylon & Hastelloy \_\_\_\_\_ \$641.00
- 01505 FM1000 SS Flowmeter Kit, 3.5-70 GPM, 500 PSI, 1" FPT, SS & nylon & Hastelloy \_\_\_\_\_ \$1,015.00
- 01515 FM270 Flowmeter Kit, 3.5-70 GPM, 225 PSI, M200 flange, PP, SS, nylon & Hastelloy \_\_\_\_\_ \$852.00
- 01515-P A FM270 P Flowmeter Kit, 3.5-70 GPM, 225 PSI, M200 flange, PP & nylon & Hastelloy \_\_\_\_\_ \$567.00
- 01898 FM270 LF Flowmeter Kit, .5-15 GPM, 225 PSI, M200 flange, PP, SS, & nylon & Hastelloy \_\_\_\_\_ \$914.00
- 01898-P A FM270 P LF Flowmeter Kit, .5-15 GPM, 225 PSI, M200 flange, PP & nylon & Hastelloy \_\_\_\_\_ \$609.00
- 01514 FM10/100 Flowmeter Kit, 10-100 GPM, 225 PSI, M200 flange, SS, PP & nylon & Hastelloy \_\_\_\_\_ \$884.00
- 01514-P A FM10/100 P Flowmeter Kit, 10-100 GPM, 225 PSI, M200 flange, PP & nylon & Hastelloy \_\_\_\_\_ \$588.00
- 01506 FM1500 SS Flowmeter Kit, 10-130 GPM, 500 PSI, 1 1/2" FPT, SS & nylon & Hastelloy \_\_\_\_\_ \$1,335.00
- 01506-P A FM1500 P SS Flowmeter Kit, 10-130 GPM, 500 PSI, 1 1/2" FPT, PP & nylon & Hastelloy \_\_\_\_\_ \$1,007.00
- 01519 FM1500 SS LF Flowmeter Kit, 3.5-70 GPM, 500 PSI, 1 1/2" FPT, SS & nylon & Hastelloy \_\_\_\_\_ \$1,391.00
- 01519-P A FM1500 P SS LF Flowmeter Kit, 3.5-70 GPM, 500 PSI, 1 1/2" FPT, PP & nylon & Hastelloy \_\_\_\_\_ \$1,047.00
- 01511 FM2000 P Flowmeter Kit, 19-198 GPM, 285 PSI, M200 flange, nylon & SS & ceramic \_\_\_\_\_ \$1,539.00
- 01513 FM3000 P Flowmeter Kit, 40-396 GPM, 285 PSI, 3" MPT, nylon & SS & ceramic \_\_\_\_\_ \$2,013.00

### Electromagnetic Flowmeter Kits

- 01901 MM2 Flowmeter Kit, .08 to 1.6 GPM, 290 PSI, 3/4" FPT, PP & SS \_\_\_\_\_ \$2,148.00
- 01821 MM3 Flowmeter Kit, .13 to 2.6 GPM, 290 PSI, 3/4" FPT, PP & SS \_\_\_\_\_ \$2,148.00
- 01822 MM5 Flowmeter Kit, .3 to 5 GPM, 290 PSI, 3/4" FPT, PP & SS \_\_\_\_\_ \$2,148.00
- 01823 MM13 Flowmeter Kit, .6 to 13 GPM, 290 PSI, 3/4" FPT, PP & SS \_\_\_\_\_ \$2,148.00
- 01824 MM26 Flowmeter Kit, 1.3 to 26 GPM 290 PSI, 1" FPT, PP & SS \_\_\_\_\_ \$2,148.00
- 01825 MM53 Flowmeter Kit, 2.6 to 53 GPM, 290 PSI, 1" FPT, PP & SS \_\_\_\_\_ \$2,148.00
- 01826 MM106 Flowmeter Kit, 5 to 106 GPM, 290 PSI, 1 1/2" FPT, PP & SS \_\_\_\_\_ \$2,148.00
- 02015 MM106FL Flowmeter Kit, 5 to 106 GPM, 290 PSI, M220 flange, PP & SS \_\_\_\_\_ \$2,148.00
- 01827 MM158 Flowmeter Kit, 8 to 158 GPM, 290 PSI, 2" MPT, PP & SS \_\_\_\_\_ \$2,148.00
- 01749 MM238 Flowmeter Kit, 12 to 238 GPM, 290 PSI, 2" MPT, PP & SS \_\_\_\_\_ \$1,439.00
- 02086 A MM528 Flowmeter Kit, 26.5 to 528 GPM, 145 PSI, 3" MPT, 3-pin MP-150 Connector, PP & SS \_\_\_\_\_ \$1,631.00

**D Flow Control****Servo Valve (Butterfly) Kits**

19093	Servo Valve, 1" butterfly, Viton® o-rings, 150 PSI _____	\$429.00
19094	Servo Valve, 1" high pressure butterfly, Viton® o-rings, 300 PSI _____	\$499.00
19095	Servo Valve, 1" butterfly, aqueous ammonia, EPDM o-rings, 150 PSI _____	\$429.00
19096	Servo Valve, M200 flanged or 1 1/2" FPT, 1" butterfly, Viton® o-rings, 150 PSI _____	\$600.00
19097	Servo Valve, M200 flanged or 1 1/2" FPT, 1.5" butterfly, Viton® o-rings, 150 PSI, M200 _____	\$600.00
19098	Servo Valve, M200 flanged or 1 1/2" FPT, 1" butterfly, aqua ammonia, EPDM o-rings, 150 PSI _____	\$600.00
19099	Servo Valve, M200 flanged or 1 1/2" FPT, 1 1/2" butterfly, aqua ammonia, EPDM o-rings, 150 PSI _____	\$600.00

**EMD - Electric Motor Driver Kits**

18008	Electric Motor Driver Kit, STD, 10 Amp _____	\$569.00
01757	Electric Motor Driver Kit, STD, 40 Amp _____	\$851.00

**EMD - Electric Motor Driver Multi-Section Adapter**

18034	Multi-Section EMD Adapter Cable, SprayMate™ II _____	\$114.85
-------	--	----------

**Hydraulic Flow Control Valve Kits**

13859	Servo Type Hydraulic Flow Control Valve, 5 GPM, 3.5 Second, SAE 8 port, 3000 PSI _____	\$1,654.00
14885	Servo Type Hydraulic Flow Control Valve, 10 GPM, 3.5 Second, SAE 8 ports, 3000 PSI _____	\$1,654.00
13857	Servo Type Hydraulic Flow Control Valve, 15 GPM, 3.5 Second, SAE 8 ports, 3000 PSI _____	\$1,654.00
13860	Servo Type Hydraulic Flow Control Valve, 20 GPM, 3.5 Second, SAE 16 ports, 3000 PSI _____	\$2,715.00
13858	Servo Type Hydraulic Flow Control Valve, 35 GPM, 3.5 Second, SAE 16 ports, 3000 PSI _____	\$2,715.00

**Hydraulic Motor/Shutoff Valve Assemblies**

17576	Hydraulic Motor/Shutoff Valve Assembly, 4.9 CID, (no sprockets) _____	\$2,318.00
-------	---	------------

**E Optional Items**

01554	RPM Sensor Kit, proximity or gear tooth sensor, w/ 15' extension cable, mounting bracket _____	\$389.00
18541	Run/Hold Sensor Kit, whisker switch, w/ magnetic mount, 10' extension cable _____	\$366.57
18529 A	Run/Hold Sensor Kit, whisker switch, (no magnetic mount) _____	\$294.92

**MP (Metri-Pack) 150 Extension Cables**

13200	Extension Cable, 2-pin MP 150, 5' _____	\$74.21
13201	Extension Cable, 2-pin MP 150, 10' _____	\$80.11
13202	Extension Cable, 2-pin MP 150, 15' _____	\$86.60
13203	Extension Cable, 2-pin MP 150, 20' _____	\$90.39
13204	Extension Cable, 2-pin MP 150, 25' _____	\$97.80
13205	Extension Cable, 3-pin MP 150, 5' _____	\$82.01
13206	Extension Cable, 3-pin MP 150, 10' _____	\$87.55
13207	Extension Cable, 3-pin MP 150, 15' _____	\$98.43
13208	Extension Cable, 3-pin MP 150, 20' _____	\$104.69
13209	Extension Cable, 3-pin MP 150, 25' _____	\$111.73
13419	Extension Cable, 3-pin MP 150, 50' _____	\$158.70
14363	Extension Cable, 10-pin MP 150, 5-16 & 5-20 gauge, 5' _____	\$150.84
14316	Extension Cable, 10-pin MP 150, 5-16 & 5-20 gauge, 10' _____	\$223.65
14317	Extension Cable, 10-pin MP 150, 5-16 & 5-20 gauge, 15' _____	\$268.87
14364	Extension Cable, 10-pin MP 150, 5-16 & 5-20 gauge, 20' _____	\$330.30
14365	Extension Cable, 10-pin MP 150, 5-16 & 5-20 gauge, 25' _____	\$388.39
14419	Extension Cable, 10-pin MP 150, 5-16 & 5-20 gauge, 50' _____	\$666.77

**WP (Weather Pack) Extension Cables**

10450	Extension Cable, 3-pin WP, 5' _____	\$76.53
10449	Extension Cable, 3-pin WP, 10' _____	\$85.79
10876	Extension Cable, 3-pin WP, 15' _____	\$97.81
10829	Extension Cable, 3-pin WP, 20' _____	\$108.24
11462	Extension Cable, 3-pin WP, 25' _____	\$118.46

*SprayMate™ II Customized Controller*

**NH3 Application - Liquifier Kits** (Liquifier kits come with one master shutoff valve, additional valves may be added)

01815	Liquifier Junior Ultra-Low Rate NH3 Kit, 600-2800 lbs. (272-1270 kg) NH3/hour _____	\$5,067.00
01816	Liquifier Junior NH3 Kit, 1000-6000 lbs. (453-2722 kg) NH3/hour _____	\$5,067.00
01817	Liquifier NH3 Kit, 1500-12000 lbs. (680-5443 kg) NH3/hour _____	\$6,760.00
01818	Liquifier Max Kit, 3100-21000 lbs. (1406-9525 kg) NH3/hour _____	\$15,004.00
17972 A	KZValve® NH3 Shutoff Valve, 1" _____	\$1,428.59

(When P/N 17972 is ordered for section control, the net price per valve is \$580.00)

**NH3 Plumbing Panel Retrofit Kits**

Includes Strainer (2 for MAX), cooler (2 for MAX), Y-pipe (MAX), vapor tubes and hoses, mounting bracket and hardware.

**Note:** flowmeter, control valve or shutoff valves are not included.

01772	Liquifier Cooler Retro Kit _____	\$3,251.00
01775	Liquifier Max Cooler Retro Kit _____	\$8,296.00

**Replacement Parts**

14311	Main Harness, NH3, SprayMate™ & SprayMate™ II, 10' _____	\$202.02
14313 F	Harness, flow, control, boom, WPT-PGS, SprayMate™ II _____	\$308.91
14314	Ignition Cable, 72" _____	\$42.97
14315 C	Power (battery) Cable, 2-pin WP, 10 Amp fuse, 15' _____	\$146.20
14469	Solenoid Adapter Cable, 3-Pin WPS to 1/4" QD _____	\$34.89
17158	Ball Valve Adapter Cable, 3-boom 2-wire, RoadMaster™ & SprayMate II™ _____	\$574.45
17782	Auto Section Cable, SprayMate II™ _____	\$383.00
17786	Multi Section Adapter Cable, SprayMate II™, NH3, 10' _____	\$228.63
17844	Multi-Section Branch Harness, NH3 _____	\$262.79
18034	Multi-Section EMD Adapter Cable, SprayMate™ II _____	\$114.85
18267	Relay, 50A 12v SPST, SprayMate™ II fertilizer kit _____	\$74.66
18777	Harness Adapter Cable, SprayMate™ Plus Console to SprayMate™ II _____	\$100.25
19749	Section Relay Module Enable _____	\$89.83
21778	Run/Hold Switch Assembly, SprayMate™ Plus, RoadMaster™, DrillMaster™ _____	\$116.30
21779	Power Switch Assembly for consoles _____	\$116.29
21963	Run/Hold Switch Assembly, SprayMate™ II, MT-NH3™ II, GSC-1000™ _____	\$116.29



# SPRAYMATE™ PLUS CUSTOMIZED CONTROLLER

Select from **A B C D E** to build custom systems

## **A** Consoles with Main Harness

### SprayMate™ Plus

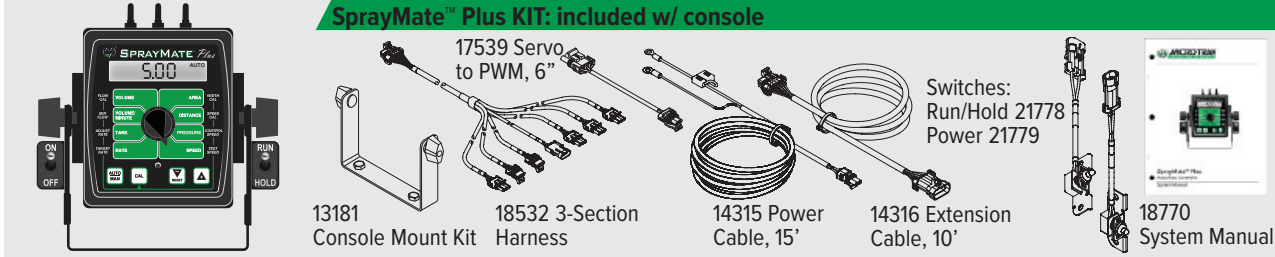

01349 SprayMate™ Plus Customized Kit, 3 section \_\_\_\_\_ \$1,574.00

## **B** Speed Sensors

- 01410 Astro™ II GPS Speed Sensor, 3-pin MP (1 Hz) \_\_\_\_\_ \$529.00
- 01425 Astro™ 5 GPS Speed Sensor, 3-pin MP (5 Hz) \_\_\_\_\_ \$707.00
- 01437 Astro™ 5 GPS Speed Sensor, 3-pin MP for Trak-Record II \_\_\_\_\_ \$754.00
- 01530 Wheel Speed Sensor Kit, Hall-effect Magnetic, w/ 10' extension cable, mounting bracket, 6 magnets \_ \$249.00
- 01531 Wheel Speed Sensor Kit, Hall-effect Magnetic, w/ 15' extension cable, mounting bracket, 6 magnets\_\_ \$270.00
- 01533 Wheel Speed Sensor Kit, Hall-effect Magnetic, w/ mounting bracket, 6 magnets \_\_\_\_\_ \$136.00
- 01554 RPM Sensor Kit, proximity or gear tooth sensor, w/ 15' extension cable, mounting bracket \_\_\_\_\_ \$389.00

## **C** Flowmeter Kits

### Turbine Type Flowmeter Kits

- 01984 FM250 P Flowmeter Kit, .08-1.6 GPM, 290 PSI, 1/4" NPT and 1/2" HB, IXEF & SS \_\_\_\_\_ \$661.00
- 01500 FM500 Flowmeter Kit, .5-5 GPM, 500 PSI, 1/2" FPT, PP & Hastelloy \_\_\_\_\_ \$520.00
- 01501 FM750 GFN Flowmeter Kit, 2-40 GPM, 150 PSI, 3/4" FPT, nylon & Hastelloy \_\_\_\_\_ \$520.00
- 01504 FM750 SS Flowmeter Kit, 2-40 GPM, 500 PSI, 3/4" FPT, SS & nylon & Hastelloy \_\_\_\_\_ \$936.00
- 01507 FM750 SS Flowmeter Kit, w/ ceramic bearings, 2-40 GPM, 500 PSI, 3/4" FPT \_\_\_\_\_ \$936.00
- 01851 FM750 LF SS Flowmeter Kit, 1-9 GPM, 500 PSI, 3/4" FPT, SS & nylon & Hastelloy \_\_\_\_\_ \$1,059.00
- 01650 FM750 GFN LF Flowmeter Kit, .5-12 GPM, 150 PSI, 3/4" FPT, nylon & Hastelloy \_\_\_\_\_ \$641.00
- 01505 FM1000 SS Flowmeter Kit, 3.5-70 GPM, 500 PSI, 1" FPT, SS & nylon & Hastelloy \_\_\_\_\_ \$1,015.00
- 01515 FM270 Flowmeter Kit, 3.5-70 GPM, 225 PSI, M200 flange, PP, SS, nylon & Hastelloy \_\_\_\_\_ \$852.00
- 01515-P A FM270 P Flowmeter Kit, 3.5-70 GPM, 225 PSI, M200 flange, PP & nylon & Hastelloy \_\_\_\_\_ \$567.00
- 01898 FM270 LF Flowmeter Kit, .5-15 GPM, 225 PSI, M200 flange, PP, SS, & nylon & Hastelloy \_\_\_\_\_ \$914.00
- 01898-P A FM270 P LF Flowmeter Kit, .5-15 GPM, 225 PSI, M200 flange, PP & nylon & Hastelloy \_\_\_\_\_ \$609.00
- 01514 FM10/100 Flowmeter Kit, 10-100 GPM, 225 PSI, M200 flange, SS, PP & nylon & Hastelloy \_\_\_\_\_ \$884.00
- 01514-P A FM10/100 P Flowmeter Kit, 10-100 GPM, 225 PSI, M200 flange, PP & nylon & Hastelloy \_\_\_\_\_ \$588.00
- 01506 FM1500 SS Flowmeter Kit, 10-130 GPM, 500 PSI, 1 1/2" FPT, SS & nylon & Hastelloy \_\_\_\_\_ \$1,335.00
- 01506-P A FM1500 P SS Flowmeter Kit, 10-130 GPM, 500 PSI, 1 1/2" FPT, PP & nylon & Hastelloy \_\_\_\_\_ \$1,007.00
- 01519 FM1500 SS LF Flowmeter Kit, 3.5-70 GPM, 500 PSI, 1 1/2" FPT, SS & nylon & Hastelloy \_\_\_\_\_ \$1,391.00
- 01519-P A FM1500 P SS LF Flowmeter Kit, 3.5-70 GPM, 500 PSI, 1 1/2" FPT, PP & nylon & Hastelloy \_\_\_\_\_ \$1,047.00
- 01511 FM2000 P Flowmeter Kit, 19-198 GPM, 285 PSI, M200 flange, nylon & SS & ceramic \_\_\_\_\_ \$1,539.00
- 01513 FM3000 P Flowmeter Kit, 40-396 GPM, 285 PSI, 3" MPT, nylon & SS & ceramic \_\_\_\_\_ \$2,013.00

### Electromagnetic Flowmeter Kits

- 01901 MM2 Flowmeter Kit, .08 to 1.6 GPM, 290 PSI, 3/4" FPT, PP & SS \_\_\_\_\_ \$2,148.00
- 01821 MM3 Flowmeter Kit, .13 to 2.6 GPM, 290 PSI, 3/4" FPT, PP & SS \_\_\_\_\_ \$2,148.00
- 01822 MM5 Flowmeter Kit, .3 to 5 GPM, 290 PSI, 3/4" FPT, PP & SS \_\_\_\_\_ \$2,148.00
- 01823 MM13 Flowmeter Kit, .6 to 13 GPM, 290 PSI, 3/4" FPT, PP & SS \_\_\_\_\_ \$2,148.00
- 01824 MM26 Flowmeter Kit, 1.3 to 26 GPM 290 PSI, 1" FPT, PP & SS \_\_\_\_\_ \$2,148.00
- 01825 MM53 Flowmeter Kit, 2.6 to 53 GPM, 290 PSI, 1" FPT, PP & SS \_\_\_\_\_ \$2,148.00
- 01826 MM106 Flowmeter Kit, 5 to 106 GPM, 290 PSI, 1 1/2" FPT, PP & SS \_\_\_\_\_ \$2,148.00
- 02015 MM106FL Flowmeter Kit, 5 to 106 GPM, 290 PSI, M220 flange, PP & SS \_\_\_\_\_ \$2,148.00
- 01827 MM158 Flowmeter Kit, 8 to 158 GPM, 290 PSI, 2" MPT, PP & SS \_\_\_\_\_ \$2,148.00
- 01749 MM238 Flowmeter Kit, 12 to 238 GPM, 290 PSI, 2" MPT, PP & SS \_\_\_\_\_ \$1,439.00
- 02086 A MM528 Flowmeter Kit, 26.5 to 528 GPM, 145 PSI, 3" MPT, 3-pin MP-150 Connector, PP & SS \_\_\_\_\_ \$1,631.00



**D** Flow Control

**Servo Valve (Butterfly) Kits**

19093	Servo Valve, 1" butterfly, Viton® o-rings, 150 PSI _____	\$429.00
19094	Servo Valve, 1" high pressure butterfly, Viton® o-rings, 300 PSI _____	\$499.00
19095	Servo Valve, 1" butterfly, aqueous ammonia, EPDM o-rings, 150 PSI _____	\$429.00
19096	Servo Valve, M200 flanged or 1 1/2" FPT, 1" butterfly, Viton® o-rings, 150 PSI _____	\$600.00
19097	Servo Valve, M200 flanged or 1 1/2" FPT, 1.5" butterfly, Viton® o-rings, 150 PSI, M200 _____	\$600.00
19098	Servo Valve, M200 flanged or 1 1/2" FPT, 1" butterfly, aqua ammonia, EPDM o-rings, 150 PSI _____	\$600.00
19099	Servo Valve, M200 flanged or 1 1/2" FPT, 1 1/2" butterfly, aqua ammonia, EPDM o-rings, 150 PSI _____	\$600.00

**EMD - Electric Motor Driver Kits**

18008	Electric Motor Driver Kit, STD, 10 Amp _____	\$569.00
01757	Electric Motor Driver Kit, STD, 40 Amp _____	\$851.00
18108	Electric Motor Driver Kit, PWM, 10 Amp _____	\$569.00
01758	Electric Motor Driver Kit, PWM, 40 Amp $\text{CE} \frac{\text{UK}}{\text{CA}}$ _____	\$851.00
01904	Electric Motor Driver Kit, PWM, w/ enable, 10 Amp _____	\$569.00
01905	Electric Motor Driver Kit, PWM, w/ enable, 40 Amp _____	\$851.00

**Hydraulic Flow Control Valve Kits**

01745	PWM Hydraulic Flow Control Valve w/ Adapter Cable, 8 GPM, SAE 8 ports, 3000 PSI _____	\$769.00
01864	PWM Hydraulic Flow Control Valve w/ Adapter Cable, 15 GPM, SAE 10 ports, 3000 PSI _____	\$1,133.00
02066 A	PWM Hydraulic Flow Control Valve w/ Adapter Cable, 25 GPM, SAE 16 ports, 3000 PSI _____	\$1,714.41
02079 A	PWM Hydraulic Flow Control Valve w/ Adapter Cable, 48 GPM, SAE 20 ports, 3000 PSI _____	\$1,513.00
13859	Servo Type Hydraulic Flow Control Valve, 5 GPM, 3.5 Second, SAE 8 port, 3000 PSI _____	\$1,654.00
14885	Servo Type Hydraulic Flow Control Valve, 10 GPM, 3.5 Second, SAE 8 ports, 3000 PSI _____	\$1,654.00
13857	Servo Type Hydraulic Flow Control Valve, 15 GPM, 3.5 Second, SAE 8 ports, 3000 PSI _____	\$1,654.00
13860	Servo Type Hydraulic Flow Control Valve, 20 GPM, 3.5 Second, SAE 16 ports, 3000 PSI _____	\$2,715.00
13858	Servo Type Hydraulic Flow Control Valve, 35 GPM, 3.5 Second, SAE 16 ports, 3000 PSI _____	\$2,715.00

**Hydraulic Motor/Shutoff Valve Assemblies**

17576	Hydraulic Motor/Shutoff Valve Assembly, 4.9 CID, (no sprockets) _____	\$2,318.00
-------	---	------------

**E** Optional Items

18754	Pressure Sensor Cable, single, 15' _____	\$100.00
18757	Pressure Sensor only, 150 PSI, 4 to 20mA _____	\$278.54
18758	Pressure Sensor only, 300 PSI, 4 to 20mA _____	\$278.54
18764	Pressure Harness Kit, single, w/ 15' sensor cable, 10' extension cable _____	\$149.32
01554	RPM Sensor Kit, proximity or gear tooth sensor, w/ 15' extension cable, mounting bracket _____	\$389.00
18541	Run/Hold Sensor Kit, whisker switch, w/ magnetic mount, 10' extension cable _____	\$366.57
18529 A	Run/Hold Sensor Kit, whisker switch, (no magnetic mount) _____	\$294.92

**MP (Metri-Pack) 150 Extension Cables**

13200	Extension Cable, 2-pin MP 150, 5' _____	\$74.21
13201	Extension Cable, 2-pin MP 150, 10' _____	\$80.11
13202	Extension Cable, 2-pin MP 150, 15' _____	\$86.60
13203	Extension Cable, 2-pin MP 150, 20' _____	\$90.39
13204	Extension Cable, 2-pin MP 150, 25' _____	\$97.80
13205	Extension Cable, 3-pin MP 150, 5' _____	\$82.01
13206	Extension Cable, 3-pin MP 150, 10' _____	\$87.55
13207	Extension Cable, 3-pin MP 150, 15' _____	\$98.43
13208	Extension Cable, 3-pin MP 150, 20' _____	\$104.69
13209	Extension Cable, 3-pin MP 150, 25' _____	\$111.73
13419	Extension Cable, 3-pin MP 150, 50' _____	\$158.70
14363	Extension Cable, 10-pin MP 150, 5-16 & 5-20 gauge, 5' _____	\$150.84
14316	Extension Cable, 10-pin MP 150, 5-16 & 5-20 gauge, 10' _____	\$223.65
14317	Extension Cable, 10-pin MP 150, 5-16 & 5-20 gauge, 15' _____	\$268.87
14364	Extension Cable, 10-pin MP 150, 5-16 & 5-20 gauge, 20' _____	\$330.30
14365	Extension Cable, 10-pin MP 150, 5-16 & 5-20 gauge, 25' _____	\$388.39
14419	Extension Cable, 10-pin MP 150, 5-16 & 5-20 gauge, 50' _____	\$666.77

## SprayMate™ Plus Customized Controller

**WP (Weather Pack) Extension Cables**

10450	Extension Cable, 3-pin WP, 5'	\$76.53
10449	Extension Cable, 3-pin WP, 10'	\$85.79
10876	Extension Cable, 3-pin WP, 15'	\$97.81
10829	Extension Cable, 3-pin WP, 20'	\$108.24
11462	Extension Cable, 3-pin WP, 25'	\$118.46

**NH3 Application - Liquifier Kits (Liquifier kits come with one master shutoff valve, additional valves may be added)**

01815	Liquifier Junior Ultra-Low Rate NH3 Kit, 600-2800 lbs. (272-1270 kg) NH3/hour	\$5,067.00
01816	Liquifier Junior NH3 Kit, 1000-6000 lbs. (453-2722 kg) NH3/hour	\$5,067.00
01817	Liquifier NH3 Kit, 1500-12000 lbs. (680-5443 kg) NH3/hour	\$6,760.00
01818	Liquifier Max Kit, 3100-21000 lbs. (1406-9525 kg) NH3/hour	\$15,004.00
17972 A	KZValve® NH3 Shutoff Valve, 1"	\$1,428.59

(When P/N 17972 is ordered for section control, the net price per valve is \$580.00)

**NH3 Plumbing Panel Retrofit Kits**

Includes Strainer (2 for MAX), cooler (2 for MAX), Y-pipe (MAX), vapor tubes and hoses, mounting bracket and hardware.

Note: flowmeter, control valve or shutoff valves are not included.

01772	Liquifier Cooler Retro Kit	\$3,251.00
01775	Liquifier Max Cooler Retro Kit	\$8,296.00

**Replacement Parts**

14315 C	Power (battery) Cable, 2-pin WP, 10 Amp fuse, 15'	\$146.20
14469	Solenoid Adapter Cable, 3-pin WPS to 1/4" QD	\$34.89
18280	Harness, flow, control, boom, WPS-PGS, SprayMate™ Plus	\$324.03
18532 A	Harness, flow, control, boom, WPT-PGS, SprayMate™ Plus	\$324.03
18777	Harness Adapter Cable, SprayMate™ Plus Console to SprayMate™ II	\$100.25
19507	Pressure Sensor Extension Cable, 50'	\$214.55
19508	Pressure Sensor Extension Cable, 25'	\$124.00
21778	Run/Hold Switch Assembly, SprayMate™ Plus, RoadMaster™, DrillMaster™	\$116.30
21779	Power Switch Assembly for consoles	\$116.29
21963	Run/Hold Switch Assembly, SprayMate™ II, MT-NH3™ II, GSC-1000™	\$116.29
16008 A	Adapter Cable, SprayMate™ Plus to Raven CR7	\$252.31
19922 A	Adapter Cable, CPC female connector, SprayMate™ Plus to Raven 440, 10'	\$263.25
15861 A	Adapter Cable, CPC male (old style) connector, SprayMate™ Plus to Raven 440, 10'	\$258.09



# RATEKING™ PLUS CUSTOMIZED CONTROLLERS

Select from **A B C D E** to build custom systems

## **A** Consoles with Main Harness

### RateKing™ Plus

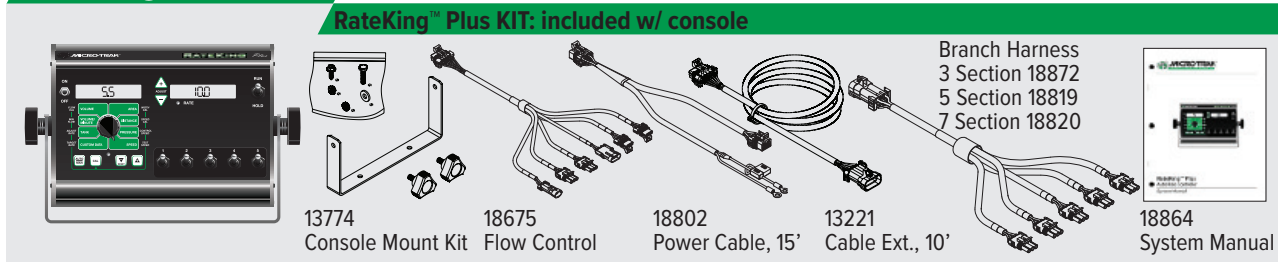

01878	RateKing™ Plus Customized Kit, 3 section _____	\$1,883.00
01881	RateKing™ Plus Customized Kit, 5 section _____	\$1,883.00
01893	RateKing™ Plus Customized Kit, 7 section _____	\$2,231.00

## **B** Speed Sensors

01410	Astro™ II GPS Speed Sensor, 3-pin MP (1 Hz) _____	\$529.00
01425	Astro™ 5 GPS Speed Sensor, 3-pin MP (5 Hz) _____	\$707.00
01437	Astro™ 5 GPS Speed Sensor, 3-pin MP for Trak-Record II _____	\$754.00
01530	Wheel Speed Sensor Kit, Hall-effect Magnetic, w/ 10' extension cable, mounting bracket, 6 magnets _____	\$249.00
01531	Wheel Speed Sensor Kit, Hall-effect Magnetic, w/ 15' extension cable, mounting bracket, 6 magnets _____	\$270.00
01533	Wheel Speed Sensor Kit, Hall-effect Magnetic, w/ mounting bracket, 6 magnets _____	\$136.00
01554	RPM Sensor Kit, proximity or gear tooth sensor, w/ 15' extension cable, mounting bracket _____	\$389.00

## **C** Flowmeter Kits

### Turbine Type Flowmeter Kits

01984	FM250 P Flowmeter Kit, .08-1.6 GPM, 290 PSI, 1/4" NPT and 1/2" HB, IXEF & SS _____	\$661.00
01500	FM500 Flowmeter Kit, .5-5 GPM, 500 PSI, 1/2" FPT, PP & Hastelloy _____	\$520.00
01501	FM750 GFN Flowmeter Kit, 2-40 GPM, 150 PSI, 3/4" FPT, nylon & Hastelloy _____	\$520.00
01504	FM750 SS Flowmeter Kit, 2-40 GPM, 500 PSI, 3/4" FPT, SS & nylon & Hastelloy _____	\$936.00
01507	FM750 SS Flowmeter Kit, w/ ceramic bearings, 2-40 GPM, 500 PSI, 3/4" FPT _____	\$936.00
01851	FM750 LF SS Flowmeter Kit, 1-9 GPM, 500 PSI, 3/4" FPT, SS & nylon & Hastelloy _____	\$1,059.00
01650	FM750 GFN LF Flowmeter Kit, .5-12 GPM, 150 PSI, 3/4" FPT, nylon & Hastelloy _____	\$641.00
01505	FM1000 SS Flowmeter Kit, 3.5-70 GPM, 500 PSI, 1" FPT, SS & nylon & Hastelloy _____	\$1,015.00
01515	FM270 Flowmeter Kit, 3.5-70 GPM, 225 PSI, M200 flange, PP, SS, nylon & Hastelloy _____	\$852.00
01515-P A	FM270 P Flowmeter Kit, 3.5-70 GPM, 225 PSI, M200 flange, PP & nylon & Hastelloy _____	\$567.00
01898	FM270 LF Flowmeter Kit, .5-15 GPM, 225 PSI, M200 flange, PP, SS, & nylon & Hastelloy _____	\$914.00
01898-P A	FM270 P LF Flowmeter Kit, .5-15 GPM, 225 PSI, M200 flange, PP & nylon & Hastelloy _____	\$609.00
01514	FM10/100 Flowmeter Kit, 10-100 GPM, 225 PSI, M200 flange, SS, PP & nylon & Hastelloy _____	\$884.00
01514-P A	FM10/100 P Flowmeter Kit, 10-100 GPM, 225 PSI, M200 flange, PP & nylon & Hastelloy _____	\$588.00
01506	FM1500 SS Flowmeter Kit, 10-130 GPM, 500 PSI, 1 1/2" FPT, SS & nylon & Hastelloy _____	\$1,335.00
01506-P A	FM1500 P SS Flowmeter Kit, 10-130 GPM, 500 PSI, 1 1/2" FPT, PP & nylon & Hastelloy _____	\$1,007.00
01519	FM1500 SS LF Flowmeter Kit, 3.5-70 GPM, 500 PSI, 1 1/2" FPT, SS & nylon & Hastelloy _____	\$1,391.00
01519-P A	FM1500 P SS LF Flowmeter Kit, 3.5-70 GPM, 500 PSI, 1 1/2" FPT, PP & nylon & Hastelloy _____	\$1,047.00
01511	FM2000 P Flowmeter Kit, 19-198 GPM, 285 PSI, M200 flange, nylon & SS & ceramic _____	\$1,539.00
01513	FM3000 P Flowmeter Kit, 40-396 GPM, 285 PSI, 3" MPT, nylon & SS & ceramic _____	\$2,013.00

## RateKing™ Plus Customized Controller

## Electromagnetic Flowmeter Kits

01901	MM2 Flowmeter Kit, .08 to 1.6 GPM, 290 PSI, 3/4" FPT, PP & SS _____	\$2,148.00
01821	MM3 Flowmeter Kit, .13 to 2.6 GPM, 290 PSI, 3/4" FPT, PP & SS _____	\$2,148.00
01822	MM5 Flowmeter Kit, .3 to 5 GPM, 290 PSI, 3/4" FPT, PP & SS _____	\$2,148.00
01823	MM13 Flowmeter Kit, .6 to 13 GPM, 290 PSI, 3/4" FPT, PP & SS _____	\$2,148.00
01824	MM26 Flowmeter Kit, 1.3 to 26 GPM 290 PSI, 1" FPT, PP & SS _____	\$2,148.00
01825	MM53 Flowmeter Kit, 2.6 to 53 GPM, 290 PSI, 1" FPT, PP & SS _____	\$2,148.00
01826	MM106 Flowmeter Kit, 5 to 106 GPM, 290 PSI, 1 1/2" FPT, PP & SS _____	\$2,148.00
02015	MM106FL Flowmeter Kit, 5 to 106 GPM, 290 PSI, M220 flange, PP & SS _____	\$2,148.00
01827	MM158 Flowmeter Kit, 8 to 158 GPM, 290 PSI, 2" MPT, PP & SS _____	\$2,148.00
01749	MM238 Flowmeter Kit, 12 to 238 GPM, 290 PSI, 2" MPT, PP & SS _____	\$1,439.00
02086 A	MM528 Flowmeter Kit, 26.5 to 528 GPM, 145 PSI, 3" MPT, 3-pin MP-150 Connector, PP & SS ____	\$1,631.00

## D Flow Control

## Servo Valve (Butterfly) Kits

19093	Servo Valve, 1" butterfly, Viton® o-rings, 150 PSI _____	\$429.00
19094	Servo Valve, 1" high pressure butterfly, Viton® o-rings, 300 PSI _____	\$499.00
19095	Servo Valve, 1" butterfly, aqueous ammonia, EPDM o-rings, 150 PSI _____	\$429.00
19096	Servo Valve, M200 flanged or 1 1/2" FPT, 1" butterfly, Viton® o-rings, 150 PSI _____	\$600.00
19097	Servo Valve, M200 flanged or 1 1/2" FPT, 1.5" butterfly, Viton® o-rings, 150 PSI, M200 _____	\$600.00
19098	Servo Valve, M200 flanged or 1 1/2" FPT, 1" butterfly, aqua ammonia, EPDM o-rings, 150 PSI ____	\$600.00
19099	Servo Valve, M200 flanged or 1 1/2" FPT, 1 1/2" butterfly, aqua ammonia, EPDM o-rings, 150 PSI _____	\$600.00

## EMD - Electric Motor Driver Kits

18008	Electric Motor Driver Kit, STD, 10 Amp _____	\$569.00
01757	Electric Motor Driver Kit, STD, 40 Amp _____	\$851.00
18108	Electric Motor Driver Kit, PWM, 10 Amp _____	\$569.00
01758	Electric Motor Driver Kit, PWM, 40 Amp $\text{C} \text{E} \text{UK} \text{CA}$ _____	\$851.00
01904	Electric Motor Driver Kit, PWM, w/ enable, 10 Amp _____	\$569.00
01905	Electric Motor Driver Kit, PWM, w/ enable, 40 Amp _____	\$851.00

## Hydraulic Flow Control Valve Kits

01745	PWM Hydraulic Flow Control Valve w/ Adapter Cable, 8 GPM, SAE 8 ports, 3000 PSI _____	\$769.00
01864	PWM Hydraulic Flow Control Valve w/ Adapter Cable, 15 GPM, SAE 10 ports, 3000 PSI _____	\$1,133.00
02066 A	PWM Hydraulic Flow Control Valve w/ Adapter Cable, 25 GPM, SAE 16 ports, 3000 PSI _____	\$1,714.41
02079 A	PWM Hydraulic Flow Control Valve w/ Adapter Cable, 48 GPM, SAE 20 ports, 3000 PSI _____	\$1,513.00
13859	Servo Type Hydraulic Flow Control Valve, 5 GPM, 3.5 Second, SAE 8 port, 3000 PSI _____	\$1,654.00
14885	Servo Type Hydraulic Flow Control Valve, 10 GPM, 3.5 Second, SAE 8 ports, 3000 PSI _____	\$1,654.00
13857	Servo Type Hydraulic Flow Control Valve, 15 GPM, 3.5 Second, SAE 8 ports, 3000 PSI _____	\$1,654.00
13860	Servo Type Hydraulic Flow Control Valve, 20 GPM, 3.5 Second, SAE 16 ports, 3000 PSI _____	\$2,715.00
13858	Servo Type Hydraulic Flow Control Valve, 35 GPM, 3.5 Second, SAE 16 ports, 3000 PSI _____	\$2,715.00

## Hydraulic Motor/Shutoff Valve Assemblies

17576	Hydraulic Motor/Shutoff Valve Assembly, 4.9 CID, (no sprockets) _____	\$2,318.00
-------	---	------------

## E Optional Items

18754	Pressure Sensor Cable, single, 15' _____	\$100.00
18757	Pressure Sensor only, 150 PSI, 4 to 20mA _____	\$278.54
18758	Pressure Sensor only, 300 PSI, 4 to 20mA _____	\$278.54
18764	Pressure Harness Kit, single, w/ 15' sensor cable, 10' extension cable _____	\$149.32
01554	RPM Sensor Kit, proximity or gear tooth sensor, w/ 15' extension cable, mounting bracket _____	\$389.00
18541	Run/Hold Sensor Kit, whisker switch, w/ magnetic mount, 10' extension cable _____	\$366.57
18529 A	Run/Hold Sensor Kit, whisker switch, (no magnetic mount) _____	\$294.92

## Optional Items-Plus Series Only

01781	Parallel Boom "Y" Cable Kit, RateKing™ Dual, 5 section _____	\$484.81
16032 A	Parallel Boom "Y" Cable Kit, RateKing™ Dual, 7 section _____	\$573.00

## (If ordering the 16032 Kit - add one of the following Section Branch Harnesses:)

18872	Section Branch Harness, 3 section WPT-PGS, 10' _____	\$249.16
18819	Section Branch Harness, 5 section WPT-PGS, 10' _____	\$285.39
18820	Section Branch Harness, 7 section WPT-PGS, 10' _____	\$326.74

## RateKing™ Plus Customized Controller

**MP (Metri-Pack) 150 Extension Cables**

13200	Extension Cable, 2-pin MP 150, 5'	\$74.21
13201	Extension Cable, 2-pin MP 150, 10'	\$80.11
13202	Extension Cable, 2-pin MP 150, 15'	\$86.60
13203	Extension Cable, 2-pin MP 150, 20'	\$90.39
13204	Extension Cable, 2-pin MP 150, 25'	\$97.80
13205	Extension Cable, 3-pin MP 150, 5'	\$82.01
13206	Extension Cable, 3-pin MP 150, 10'	\$87.55
13207	Extension Cable, 3-pin MP 150, 15'	\$98.43
13208	Extension Cable, 3-pin MP 150, 20'	\$104.69
13209	Extension Cable, 3-pin MP 150, 25'	\$111.73
13419	Extension Cable, 3-pin MP 150, 50'	\$158.70
13220	Extension Cable, 10-pin MP 150, 5'	\$142.53
13221	Extension Cable, 10-pin MP 150, 10'	\$170.20
13222	Extension Cable, 10-pin MP 150, 15'	\$194.62
13223	Extension Cable, 10-pin MP150, 20'	\$233.12
13224	Extension Cable, 10-pin MP 150, 25'	\$274.69
17095	Extension Cable, 10-pin MP 150, 30'	\$324.70
10450	Extension Cable, 3-pin WP, 5'	\$76.53
10449	Extension Cable, 3-pin WP, 10'	\$85.79
10876	Extension Cable, 3-pin WP, 15'	\$97.81
10829	Extension Cable, 3-pin WP, 20'	\$108.24
11462	Extension Cable, 3-pin WP, 25'	\$118.46
18823	Extension Cable, 6-pin MP 150, 5'	\$67.99
18756	Extension Cable, 6-pin MP 150, 10'	\$107.35
18824	Extension Cable, 6-pin MP 150, 15'	\$127.05
18825	Extension Cable, 6-pin MP 150, 20'	\$178.89
18826	Extension Cable, 6-pin MP 150, 25'	\$186.98

**NH3 Application - Liquifier Kits (Liquifier kits come with one master shutoff valve, additional valves may be added)**

01815	Liquifier Junior Ultra-Low Rate NH3 Kit, 600-2800 lbs. (272-1270 kg) NH3/hour	\$5,067.00
01816	Liquifier Junior NH3 Kit, 1000-6000 lbs. (453-2722 kg) NH3/hour	\$5,067.00
01817	Liquifier NH3 Kit, 1500-12000 lbs. (680-5443 kg) NH3/hour	\$6,760.00
01818	Liquifier Max Kit, 3100-21000 lbs. (1406-9525 kg) NH3/hour	\$15,004.00
17972 A	KZValve® NH3 Shutoff Valve, 1"	\$1,428.59

(When P/N 17972 is ordered for section control, the net price per valve is \$580.00)

**NH3 Plumbing Panel Retrofit Kits**

Includes Strainer (2 for MAX), cooler (2 for MAX), Y-pipe (MAX), vapor tubes and hoses, mounting bracket and hardware.

**Note: flowmeter, control valve or shutoff valves are not included.**

01772	Liquifier Cooler Retro Kit	\$3,251.00
01775	Liquifier Max Cooler Retro Kit	\$8,296.00

**Replacement Parts**

18802	Power Cable, 15 Amp fuse, 15'	\$344.92
18872	Section Branch Harness, 3 section, WPT-PGS, 10'	\$249.16
18819	Section Branch Harness, 5 section, WPT-PGS, 10'	\$285.39
18820	Section Branch Harness, 7 section, WPT-PGS, 10'	\$326.74
18675 B	Control Branch Harness, RateKing™, 10'	\$377.10
18676 B	Control Branch Harness, RateKing™ Dual Plus Channel 2, 10' Dual Plus Channel 2 Harness	\$279.00
18757	Pressure Sensor only, 150 PSI, 4 to 20mA	\$278.54
18758	Pressure Sensor only, 300 PSI, 4 to 20mA	\$278.54
18754	Single Pressure Sensor Cable, Plus Series	\$100.00
18755	Dual Pressure Sensor Cable, Plus console	\$176.97
19507	Pressure Sensor Extension Cable, 50'	\$214.55
19508	Pressure Sensor Extension Cable, 25'	\$124.00
19978 A	Cable, RateKing™ Plus to Raven Console	\$718.47
19979 A	Cable, RateKing™ Dual Plus to Raven Console	\$913.69

# RATEKING™ DUAL PLUS CUSTOMIZED CONTROLLERS

Select from **A B C D E** to build custom systems

## **A** Consoles with Main Harness

### RateKing™ Dual Plus

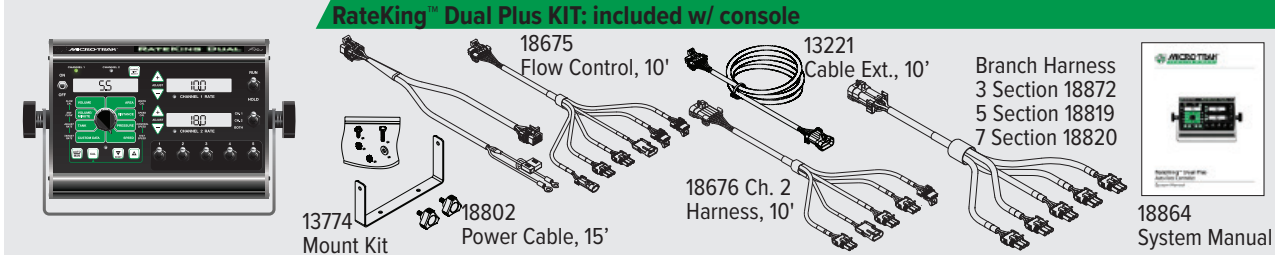

01909	RateKing™ Dual Plus Customized Kit, 3 section, w/ channel 1 & channel 2 harnesses_____	\$3,213.00
01899	RateKing™ Dual Plus Customized Kit, 5 section, w/ channel 1 & channel 2 harnesses_____	\$3,213.00
01910	RateKing™ Dual Plus Customized Kit, 7 section, w/ channel 1 & channel 2 harnesses_____	\$3,697.00

## **B** Speed Sensors

01410	Astro™ II GPS Speed Sensor, 3-pin MP (1 Hz) _____	\$529.00
01425	Astro™ 5 GPS Speed Sensor, 3-pin MP (5 Hz) _____	\$707.00
01437	Astro™ 5 GPS Speed Sensor, 3-pin MP for Trak-Record II _____	\$754.00
01530	Wheel Speed Sensor Kit, Hall-effect Magnetic, w/ 10' extension cable, mounting bracket, 6 magnets _	\$249.00
01531	Wheel Speed Sensor Kit, Hall-effect Magnetic, w/ 15' extension cable, mounting bracket, 6 magnets__	\$270.00
01533	Wheel Speed Sensor Kit, Hall-effect Magnetic, w/ mounting bracket, 6 magnets_____	\$136.00
01554	RPM Sensor Kit, proximity or gear tooth sensor, w/ 15' extension cable, mounting bracket_____	\$389.00

## **C** Flowmeter Kits

### Turbine Type Flowmeter Kits

01984	FM250 P Flowmeter Kit, .08-1.6 GPM, 290 PSI, 1/4" NPT and 1/2" HB, IXEF & SS _____	\$661.00
01500	FM500 Flowmeter Kit, .5-5 GPM, 500 PSI, 1/2" FPT, PP & Hastelloy _____	\$520.00
01501	FM750 GFN Flowmeter Kit, 2-40 GPM, 150 PSI, 3/4" FPT, nylon & Hastelloy _____	\$520.00
01504	FM750 SS Flowmeter Kit, 2-40 GPM, 500 PSI, 3/4" FPT, SS & nylon & Hastelloy _____	\$936.00
01507	FM750 SS Flowmeter Kit, w/ ceramic bearings, 2-40 GPM, 500 PSI, 3/4" FPT _____	\$936.00
01851	FM750 LF SS Flowmeter Kit, 1-9 GPM, 500 PSI, 3/4" FPT, SS & nylon & Hastelloy _____	\$1,059.00
01650	FM750 GFN LF Flowmeter Kit, .5-12 GPM, 150 PSI, 3/4" FPT, nylon & Hastelloy _____	\$641.00
01505	FM1000 SS Flowmeter Kit, 3.5-70 GPM, 500 PSI, 1" FPT, SS & nylon & Hastelloy _____	\$1,015.00
01515	FM270 Flowmeter Kit, 3.5-70 GPM, 225 PSI, M200 flange, PP, SS, nylon & Hastelloy _____	\$852.00
01515-P A	FM270 P Flowmeter Kit, 3.5-70 GPM, 225 PSI, M200 flange, PP & nylon & Hastelloy _____	\$567.00
01898	FM270 LF Flowmeter Kit, .5-15 GPM, 225 PSI, M200 flange, PP, SS, & nylon & Hastelloy _____	\$914.00
01898-P A	FM270 P LF Flowmeter Kit, .5-15 GPM, 225 PSI, M200 flange, PP & nylon & Hastelloy _____	\$609.00
01514	FM10/100 Flowmeter Kit, 10-100 GPM, 225 PSI, M200 flange, SS, PP & nylon & Hastelloy _____	\$884.00
01514-P A	FM10/100 P Flowmeter Kit, 10-100 GPM, 225 PSI, M200 flange, PP & nylon & Hastelloy _____	\$588.00
01506	FM1500 SS Flowmeter Kit, 10-130 GPM, 500 PSI, 1 1/2" FPT, SS & nylon & Hastelloy _____	\$1,335.00
01506-P A	FM1500 P SS Flowmeter Kit, 10-130 GPM, 500 PSI, 1 1/2" FPT, PP & nylon & Hastelloy _____	\$1,007.00
01519	FM1500 SS LF Flowmeter Kit, 3.5-70 GPM, 500 PSI, 1 1/2" FPT, SS & nylon & Hastelloy _____	\$1,391.00
01519-P A	FM1500 P SS LF Flowmeter Kit, 3.5-70 GPM, 500 PSI, 1 1/2" FPT, PP & nylon & Hastelloy_____	\$1,047.00
01511	FM2000 P Flowmeter Kit, 19-198 GPM, 285 PSI, M200 flange, nylon & SS & ceramic _____	\$1,539.00
01513	FM3000 P Flowmeter Kit, 40-396 GPM, 285 PSI, 3" MPT, nylon & SS & ceramic _____	\$2,013.00
01513	FM3000 P Flowmeter Kit, 40-396 GPM, 285 PSI, 3" MPT, nylon & SS & ceramic _____	\$1,926.00

## RateKing™ Dual Plus Customized Controller

**Electromagnetic Flowmeter Kits**

01901	MM2 Flowmeter Kit, .08 to 1.6 GPM, 290 PSI, 3/4" FPT, PP & SS _____	\$2,148.00
01821	MM3 Flowmeter Kit, .13 to 2.6 GPM, 290 PSI, 3/4" FPT, PP & SS _____	\$2,148.00
01822	MM5 Flowmeter Kit, .3 to 5 GPM, 290 PSI, 3/4" FPT, PP & SS _____	\$2,148.00
01823	MM13 Flowmeter Kit, .6 to 13 GPM, 290 PSI, 3/4" FPT, PP & SS _____	\$2,148.00
01824	MM26 Flowmeter Kit, 1.3 to 26 GPM 290 PSI, 1" FPT, PP & SS _____	\$2,148.00
01825	MM53 Flowmeter Kit, 2.6 to 53 GPM, 290 PSI, 1" FPT, PP & SS _____	\$2,148.00
01826	MM106 Flowmeter Kit, 5 to 106 GPM, 290 PSI, 1 1/2" FPT, PP & SS _____	\$2,148.00
02015	MM106FL Flowmeter Kit, 5 to 106 GPM, 290 PSI, M220 flange, PP & SS _____	\$2,148.00
01827	MM158 Flowmeter Kit, 8 to 158 GPM, 290 PSI, 2" MPT, PP & SS _____	\$2,148.00
01749	MM238 Flowmeter Kit, 12 to 238 GPM, 290 PSI, 2" MPT, PP & SS _____	\$1,439.00
02086 A	MM528 Flowmeter Kit, 26.5 to 528 GPM, 145 PSI, 3" MPT, 3-pin MP-150 Connector, PP & SS ____	\$1,631.00

**D Flow Control****Servo Valve (Butterfly) Kits**

19093	Servo Valve, 1" butterfly, Viton® o-rings, 150 PSI _____	\$429.00
19094	Servo Valve, 1" high pressure butterfly, Viton® o-rings, 300 PSI _____	\$499.00
19095	Servo Valve, 1" butterfly, aqueous ammonia, EPDM o-rings, 150 PSI _____	\$429.00
19096	Servo Valve, M200 flanged or 1 1/2" FPT, 1" butterfly, Viton® o-rings, 150 PSI _____	\$600.00
19097	Servo Valve, M200 flanged or 1 1/2" FPT, 1.5" butterfly, Viton® o-rings, 150 PSI, M200 _____	\$600.00
19098	Servo Valve, M200 flanged or 1 1/2" FPT, 1" butterfly, aqua ammonia, EPDM o-rings, 150 PSI ____	\$600.00
19099	Servo Valve, M200 flanged or 1 1/2" FPT, 1 1/2" butterfly, aqua ammonia, EPDM o-rings, 150 PSI	\$600.00

**EMD - Electric Motor Driver Kits**

18008	Electric Motor Driver Kit, STD, 10 Amp _____	\$569.00
01757	Electric Motor Driver Kit, STD, 40 Amp _____	\$851.00
18108	Electric Motor Driver Kit, PWM, 10 Amp _____	\$569.00
01758	Electric Motor Driver Kit, PWM, 40 Amp  _____	\$851.00
01904	Electric Motor Driver Kit, PWM, w/ enable, 10 Amp _____	\$569.00
01905	Electric Motor Driver Kit, PWM, w/ enable, 40 Amp _____	\$851.00

**Hydraulic Flow Control Valve Kits**

01745	PWM Hydraulic Flow Control Valve w/ Adapter Cable, 8 GPM, SAE 8 ports, 3000 PSI _____	\$769.00
01864	PWM Hydraulic Flow Control Valve w/ Adapter Cable, 15 GPM, SAE 10 ports, 3000 PSI _____	\$1,133.00
02066 A	PWM Hydraulic Flow Control Valve w/ Adapter Cable, 25 GPM, SAE 16 ports, 3000 PSI _____	\$1,714.41
02079 A	PWM Hydraulic Flow Control Valve w/ Adapter Cable, 48 GPM, SAE 20 ports, 3000 PSI _____	\$1,513.00
13859	Servo Type Hydraulic Flow Control Valve, 5 GPM, 3.5 Second, SAE 8 port, 3000 PSI _____	\$1,654.00
14885	Servo Type Hydraulic Flow Control Valve, 10 GPM, 3.5 Second, SAE 8 ports, 3000 PSI _____	\$1,654.00
13857	Servo Type Hydraulic Flow Control Valve, 15 GPM, 3.5 Second, SAE 8 ports, 3000 PSI _____	\$1,654.00
13860	Servo Type Hydraulic Flow Control Valve, 20 GPM, 3.5 Second, SAE 16 ports, 3000 PSI _____	\$2,715.00
13858	Servo Type Hydraulic Flow Control Valve, 35 GPM, 3.5 Second, SAE 16 ports, 3000 PSI _____	\$2,715.00

**Hydraulic Motor/Shutoff Valve Assemblies**

17576	Hydraulic Motor/Shutoff Valve Assembly, 4.9 CID, (no sprockets) _____	\$2,318.00
-------	---	------------

**E Optional Items**

18754	Pressure Sensor Cable, single, 15' _____	\$100.00
18757	Pressure Sensor only, 150 PSI, 4 to 20mA _____	\$278.54
18758	Pressure Sensor only, 300 PSI, 4 to 20mA _____	\$278.54
18764	Pressure Harness Kit, single, w/ 15' sensor cable, 10' extension cable _____	\$149.32
01554	RPM Sensor Kit, proximity or gear tooth sensor, w/ 15' extension cable, mounting bracket _____	\$389.00
18541	Run/Hold Sensor Kit, whisker switch, w/ magnetic mount, 10' extension cable _____	\$366.57
18529 A	Run/Hold Sensor Kit, whisker switch, (no magnetic mount) _____	\$294.92

**MP (Metri-Pack) 150 Extension Cables**

13200	Extension Cable, 2-pin MP 150, 5' _____	\$74.21
13201	Extension Cable, 2-pin MP 150, 10' _____	\$80.11
13202	Extension Cable, 2-pin MP 150, 15' _____	\$86.60
13203	Extension Cable, 2-pin MP 150, 20' _____	\$90.39
13204	Extension Cable, 2-pin MP 150, 25' _____	\$97.80
13205	Extension Cable, 3-pin MP 150, 5' _____	\$82.01

**RateKing™ Dual Plus Customized Controller**

13206	Extension Cable, 3-pin MP 150, 10'	\$87.55
13207	Extension Cable, 3-pin MP 150, 15'	\$98.43
13208	Extension Cable, 3-pin MP 150, 20'	\$104.69
13209	Extension Cable, 3-pin MP 150, 25'	\$111.73
13419	Extension Cable, 3-pin MP 150, 50'	\$158.70
13220	Extension Cable, 10-pin MP 150, 5'	\$142.53
13221	Extension Cable, 10-pin MP 150, 10'	\$170.20
13222	Extension Cable, 10-pin MP 150, 15'	\$194.62
13223	Extension Cable, 10-pin MP150, 20'	\$233.12
13224	Extension Cable, 10-pin MP 150, 25'	\$274.69
17095	Extension Cable, 10-pin MP 150, 30'	\$324.70
17096	Extension Cable, 10-pin MP 150, 40'	\$390.09
17269	Extension Cable, 10-pin MP 150, 45'	\$428.53
14142	Extension Cable, 10-pin MP 150, 50'	\$506.84
10450	Extension Cable, 3-pin WP, 5'	\$76.53
10449	Extension Cable, 3-pin WP, 10'	\$85.79
10876	Extension Cable, 3-pin WP, 15'	\$97.81
10829	Extension Cable, 3-pin WP, 20'	\$108.24
11462	Extension Cable, 3-pin WP, 25'	\$118.46
18823	Extension Cable, 6-pin MP 150, 5'	\$67.99
18756	Extension Cable, 6-pin MP 150, 10'	\$107.35
18824	Extension Cable, 6-pin MP 150, 15'	\$127.05
18825	Extension Cable, 6-pin MP 150, 20'	\$178.89
18826	Extension Cable, 6-pin MP 150, 25'	\$186.98
18830	Extension Cable, 7-Pin MP 150/480, 2-12 & 5 -20 gauge, 5'	\$159.41
18831	Extension Cable, 7-Pin MP 150/480, 2-12 & 5 -20 gauge, 10'	\$206.00
18832	Extension Cable, 7-Pin MP 150/480, 2-12 & 5 -20 gauge, 15'	\$243.19
18833	Extension Cable, 7-Pin MP 150/480, 2-12 & 5 -20 gauge, 20'	\$285.27
18834	Extension Cable, 7-Pin MP 150/480, 2-12 & 5 -20 gauge, 25'	\$327.11
18835	Extension Cable, 7-Pin MP 150/480, 2-12 & 5 -20 gauge, 50'	\$536.64

**NH3 Application - Liquifier Kits (Liquifier kits come with one master shutoff valve, additional valves may be added)**

01815	Liquifier Junior Ultra-Low Rate NH3 Kit, 600-2800 lbs. (272-1270 kg) NH3/hour	\$5,067.00
01816	Liquifier Junior NH3 Kit, 1000-6000 lbs. (453-2722 kg) NH3/hour	\$5,067.00
01817	Liquifier NH3 Kit, 1500-12000 lbs. (680-5443 kg) NH3/hour	\$6,760.00
01818	Liquifier Max Kit, 3100-21000 lbs. (1406-9525 kg) NH3/hour	\$15,004.00
17972 A	KZValve® NH3 Shutoff Valve, 1" _____	\$1,428.59

(When P/N 17972 is ordered for section control, the net price per valve is \$580.00)

**NH3 Plumbing Panel Retrofit Kits**

Includes Strainer (2 for MAX), cooler (2 for MAX), Y-pipe (MAX), vapor tubes and hoses, mounting bracket and hardware.

**Note: flowmeter, control valve or shutoff valves are not included.**

01772	Liquifier Cooler Retro Kit _____	\$3,251.00
01775	Liquifier Max Cooler Retro Kit _____	\$8,296.00

**Replacement Parts**

18802	Power Cable, 15 Amp fuse, 15' _____	\$344.92
18872	Section Branch Harness, 3 section, WPT-PGS, 10' _____	\$249.16
18819	Section Branch Harness, 5 section, WPT-PGS, 10' _____	\$285.39
18820	Section Branch Harness, 7 section, WPT-PGS, 10' _____	\$326.74
18675 B	Control Branch Harness, RateKing™, 10' _____	\$377.10
18676 B	Control Branch Harness, RateKing™ Dual Plus Channel 2, 10' Dual Plus Channel 2 Harness _____	\$279.00
18757	Pressure Sensor only, 150 PSI, 4 to 20mA _____	\$278.54
18758	Pressure Sensor only, 300 PSI, 4 to 20mA _____	\$278.54
18754	Single Pressure Sensor Cable, Plus Series _____	\$100.00
18755	Dual Pressure Sensor Cable, Plus console _____	\$176.97
19507	Pressure Sensor Extension Cable, 50' _____	\$214.55
19508	Pressure Sensor Extension Cable, 25' _____	\$124.00
19978 A	Cable, RateKing™ Plus to Raven Console _____	\$718.47
19979 A	Cable, RateKing™ Dual Plus to Raven Console _____	\$913.69



# DUAL ISOMOD™ CUSTOMIZED CONTROLLERS

Select from **A B C D E F G** to build custom systems

Dual ISOmod™

01845 KIT: included w/ ISOmod

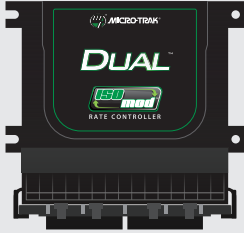

19604 Bulkhead Harness, 2'



19605 Channel 1 Branch Harness, 10'



18436 Extension Cable, 15'



01953 Power Cable, 30'



19603 System Manual

## A Dual ISOmod™ Product Rate Controller Kits

01845	Dual ISOmod™ Kit, single product rate control, w/ power cable & channel 1 harness	\$2,373.00
02034	Dual ISOmod™ Kit, single product rate control, w/ channel 1 harness, w/o power cable	\$2,126.00
01993	Dual ISOmod™ Kit, dual product rate control, w/ power cable & channel 1 & channel 2 harnesses	\$2,620.00
02035	Dual ISOmod™ Kit, dual product rate control, w/ channel 1 & channel 2 harnesses, w/o power cable	\$2,370.00
02059 A	Dual ISOmod™ Kit, w/ Raven adapter cable, w/ power cable	\$2,620.00
02060 A	Dual ISOmod™ Kit, w/ Raven adapter cable, w/o power cable	\$2,370.00

## B ISOmod™ Section Branch Cables

19669	Branch Harness, Dual ISOmod™, 6 section, 10'	\$331.00
19670	Branch Harness, Dual ISOmod™, 12 section WPT-PGS, 10'	\$600.00
16013 A	Branch Cable, Dual ISOmod™, 6 section ZV (zipvalve), 10'	\$416.00
16014 A	Branch Cable, Dual ISOmod™, 12 section ZV (zipvalve), 10'	\$777.00
15871 A	Parallel Boom "Y" Cable, Dual ISOmod™	\$179.19

(If ordering the 15871 kit, two 16013, 16014, 19669 or 19670 cables are required for a parallel boom configuration)

## C IBIC Breakaway Implement Cable or ISOmod™ Tap Cables

18921	IBIC Breakaway Implement Cable, no power connection, 10'	\$714.00
19700 C	IBIC Breakaway Implement Cable, w/ power connection, 10'	\$833.00
15891 B	IBIC Breakaway Implement Cable, w/ power connection, 30'	\$1,246.00
18894	ISOBUS Tap Cable, 6-pin MP 150	\$255.00
18895 A	ISOBUS Tap Cable, 12-pin Ampseal, John Deere®	\$255.00
18896	ISOBUS Tap Cable, 4-pin Delphi MP 630, Great Plains/Dickey JOHN®	\$255.00
18897	ISOBUS Tap Cable, 8-pin GT280, Case IH®	\$255.00
19857	ISOBUS Tap Cable Kit, w/ 6-pin MP150, 18894 and 18955 ECU power adapter cable	\$343.00
18955	Adapter Cable Kit, ECU power	\$160.00
16041 A	ISOBUS Tap Cable, 12-pin Deutsch, Case IH® 2100 Series Planter	\$255.00
18944	Tap Cable (in-cab) Kit, w/ power cable, Deutsch DTM	\$255.00
18945	Tap Cable (in-cab) Kit, w/ power cable, Deutsch DT	\$343.00
18950	Tap Cable (in-cab) Kit, w/ power adapter, Deutsch DT	\$343.00
18967	Terminator Cable, w/TBC Plug, Deutsch DT	\$201.04
18968	Terminator Cable, w/TBC Plug, Deutsch DTM	\$223.00

### Extension Cable Options

19774	ISOBUS Extension Cable, 6-pin MP 150, 5'	\$212.15
19775	ISOBUS Extension Cable, 6-pin MP 150, 10'	\$232.68
19776	ISOBUS Extension Cable, 6-pin MP 150, 20'	\$273.63
19777	ISOBUS Extension Cable, 6-pin MP 150, 30'	\$314.71
19778	ISOBUS Extension Cable, 6-pin MP 150, 40'	\$355.79

## D Speed Sensors (Not required if speed is available via ISOBUS)

01410	Astro™ II GPS Speed Sensor, 3-pin MP (1 Hz)	\$529.00
01425	Astro™ 5 GPS Speed Sensor, 3-pin MP (5 Hz)	\$707.00
01554	RPM Sensor Kit, proximity or gear tooth sensor, w/ 15' extension cable, mounting bracket	\$389.00

**Flowmeter Kits****Turbine Type Flowmeter Kits**

01984	FM250 P Flowmeter Kit, .08-1.6 GPM, 290 PSI, 1/4" NPT and 1/2" HB, IXEF & SS _____	\$661.00
01500	FM500 Flowmeter Kit, .5-5 GPM, 500 PSI, 1/2" FPT, PP & Hastelloy _____	\$520.00
01501	FM750 GFN Flowmeter Kit, 2-40 GPM, 150 PSI, 3/4" FPT, nylon & Hastelloy _____	\$520.00
01504	FM750 SS Flowmeter Kit, 2-40 GPM, 500 PSI, 3/4" FPT, SS & nylon & Hastelloy _____	\$936.00
01507	FM750 SS Flowmeter Kit, w/ ceramic bearings, 2-40 GPM, 500 PSI, 3/4" FPT _____	\$936.00
01851	FM750 LF SS Flowmeter Kit, 1-9 GPM, 500 PSI, 3/4" FPT, SS & nylon & Hastelloy _____	\$1,059.00
01650	FM750 GFN LF Flowmeter Kit, .5-12 GPM, 150 PSI, 3/4" FPT, nylon & Hastelloy _____	\$641.00
01505	FM1000 SS Flowmeter Kit, 3.5-70 GPM, 500 PSI, 1" FPT, SS & nylon & Hastelloy _____	\$1,015.00
01515	FM270 Flowmeter Kit, 3.5-70 GPM, 225 PSI, M200 flange, PP, SS, nylon & Hastelloy _____	\$852.00
01515-P A	FM270 P Flowmeter Kit, 3.5-70 GPM, 225 PSI, M200 flange, PP & nylon & Hastelloy _____	\$567.00
01898	FM270 LF Flowmeter Kit, .5-15 GPM, 225 PSI, M200 flange, PP, SS, & nylon & Hastelloy _____	\$914.00
01898-P A	FM270 P LF Flowmeter Kit, .5-15 GPM, 225 PSI, M200 flange, PP & nylon & Hastelloy _____	\$609.00
01514	FM10/100 Flowmeter Kit, 10-100 GPM, 225 PSI, M200 flange, SS, PP & nylon & Hastelloy _____	\$884.00
01514-P A	FM10/100 P Flowmeter Kit, 10-100 GPM, 225 PSI, M200 flange, PP & nylon & Hastelloy _____	\$588.00
01506	FM1500 SS Flowmeter Kit, 10-130 GPM, 500 PSI, 1 1/2" FPT, SS & nylon & Hastelloy _____	\$1,335.00
01506-P A	FM1500 P SS Flowmeter Kit, 10-130 GPM, 500 PSI, 1 1/2" FPT, PP & nylon & Hastelloy _____	\$1,007.00
01519	FM1500 SS LF Flowmeter Kit, 3.5-70 GPM, 500 PSI, 1 1/2" FPT, SS & nylon & Hastelloy _____	\$1,391.00
01519-P A	FM1500 P SS LF Flowmeter Kit, 3.5-70 GPM, 500 PSI, 1 1/2" FPT, PP & nylon & Hastelloy _____	\$1,047.00
01511	FM2000 P Flowmeter Kit, 19-198 GPM, 285 PSI, M200 flange, nylon & SS & ceramic _____	\$1,539.00
01513	FM3000 P Flowmeter Kit, 40-396 GPM, 285 PSI, 3" MPT, nylon & SS & ceramic _____	\$2,013.00

**Electromagnetic Flowmeter Kits**

01901	MM2 Flowmeter Kit, .08 to 1.6 GPM, 290 PSI, 3/4" FPT, PP & SS _____	\$2,148.00
01821	MM3 Flowmeter Kit, .13 to 2.6 GPM, 290 PSI, 3/4" FPT, PP & SS _____	\$2,148.00
01822	MM5 Flowmeter Kit, .3 to 5 GPM, 290 PSI, 3/4" FPT, PP & SS _____	\$2,148.00
01823	MM13 Flowmeter Kit, .6 to 13 GPM, 290 PSI, 3/4" FPT, PP & SS _____	\$2,148.00
01824	MM26 Flowmeter Kit, 1.3 to 26 GPM 290 PSI, 1" FPT, PP & SS _____	\$2,148.00
01825	MM53 Flowmeter Kit, 2.6 to 53 GPM, 290 PSI, 1" FPT, PP & SS _____	\$2,148.00
01826	MM106 Flowmeter Kit, 5 to 106 GPM, 290 PSI, 1 1/2" FPT, PP & SS _____	\$2,148.00
02015	MM106FL Flowmeter Kit, 5 to 106 GPM, 290 PSI, M220 flange, PP & SS _____	\$2,148.00
01827	MM158 Flowmeter Kit, 8 to 158 GPM, 290 PSI, 2" MPT, PP & SS _____	\$2,148.00
01749	MM238 Flowmeter Kit, 12 to 238 GPM, 290 PSI, 2" MPT, PP & SS _____	\$1,439.00
02086 A	MM528 Flowmeter Kit, 26.5 to 528 GPM, 145 PSI, 3" MPT, 3-pin MP-150 Connector, PP & SS _____	\$1,631.00

**Flow Control Servo Valve (Butterfly) Kits**

19093	Servo Valve, 1" butterfly, Viton® o-rings, 150 PSI _____	\$429.00
19094	Servo Valve, 1" high pressure butterfly, Viton® o-rings, 300 PSI _____	\$499.00
19095	Servo Valve, 1" butterfly, aqueous ammonia, EPDM o-rings, 150 PSI _____	\$429.00
19096	Servo Valve, M200 flanged or 1 1/2" FPT, 1" butterfly, Viton® o-rings, 150 PSI _____	\$600.00
19097	Servo Valve, M200 flanged or 1 1/2" FPT, 1.5" butterfly, Viton® o-rings, 150 PSI, M200 _____	\$600.00
19098	Servo Valve, M200 flanged or 1 1/2" FPT, 1" butterfly, aqua ammonia, EPDM o-rings, 150 PSI _____	\$600.00
19099	Servo Valve, M200 flanged or 1 1/2" FPT, 1 1/2" butterfly, aqua ammonia, EPDM o-rings, 150 PSI _____	\$600.00

**EMD - Electric Motor Driver Kits**

18008	Electric Motor Driver Kit, STD, 10 Amp _____	\$569.00
01757	Electric Motor Driver Kit, STD, 40 Amp _____	\$851.00
18108	Electric Motor Driver Kit, PWM, 10 Amp _____	\$569.00
01758	Electric Motor Driver Kit, PWM, 40 Amp  _____	\$851.00
01904	Electric Motor Driver Kit, PWM, w/ enable, 10 Amp _____	\$569.00
01905	Electric Motor Driver Kit, PWM, w/ enable, 40 Amp _____	\$851.00

**Hydraulic Flow Control Valve Kits**

01745	PWM Hydraulic Flow Control Valve w/ Adapter Cable, 8 GPM, SAE 8 ports, 3000 PSI _____	\$769.00
01864	PWM Hydraulic Flow Control Valve w/ Adapter Cable, 15 GPM, SAE 10 ports, 3000 PSI _____	\$1,133.00
02066 A	PWM Hydraulic Flow Control Valve w/ Adapter Cable, 25 GPM, SAE 16 ports, 3000 PSI _____	\$1,714.41
02079 A	PWM Hydraulic Flow Control Valve w/ Adapter Cable, 48 GPM, SAE 20 ports, 3000 PSI _____	\$1,513.00
13859	Servo Type Hydraulic Flow Control Valve, 5 GPM, 3.5 Second, SAE 8 port, 3000 PSI _____	\$1,654.00
14885	Servo Type Hydraulic Flow Control Valve, 10 GPM, 3.5 Second, SAE 8 ports, 3000 PSI _____	\$1,654.00
13857	Servo Type Hydraulic Flow Control Valve, 15 GPM, 3.5 Second, SAE 8 ports, 3000 PSI _____	\$1,654.00
13860	Servo Type Hydraulic Flow Control Valve, 20 GPM, 3.5 Second, SAE 16 ports, 3000 PSI _____	\$2,715.00
13858	Servo Type Hydraulic Flow Control Valve, 35 GPM, 3.5 Second, SAE 16 ports, 3000 PSI _____	\$2,715.00

*Dual ISOmod™ Customized Controller***Hydraulic Motor/Shutoff Valve Assemblies**

17576	Hydraulic Motor/Shutoff Valve Assembly, 4.9 CID, (no sprockets)	\$2,318.00
-------	---	------------

**Optional Items**

18754	Pressure Sensor Cable, single, 15'	\$100.00
18757	Pressure Sensor only, 150 PSI, 4 to 20mA	\$278.54
18758	Pressure Sensor only, 300 PSI, 4 to 20mA	\$278.54
18764	Pressure Harness Kit, single, w/ 15' sensor cable, 10' extension cable	\$149.32
01554	RPM Sensor Kit, proximity or gear tooth sensor, w/ 15' extension cable, mounting bracket	\$389.00
18541	Run/Hold Sensor Kit, whisker switch, w/ magnetic mount, 10' extension cable	\$366.57
18529 A	Run/Hold Sensor Kit, whisker switch, (no magnetic mount)	\$294.92

**MP (Metri-Pack) 150 Extension Cables**

13205	Extension Cable, 3-pin MP 150, 5'	\$82.01
13206	Extension Cable, 3-pin MP 150, 10'	\$87.55
13207	Extension Cable, 3-pin MP 150, 15'	\$98.43
13208	Extension Cable, 3-pin MP 150, 20'	\$104.69
13209	Extension Cable, 3-pin MP 150, 25'	\$111.73
13419	Extension Cable, 3-pin MP 150, 50'	\$158.70
13220	Extension Cable, 10-pin MP 150, 5'	\$142.53
13221	Extension Cable, 10-pin MP 150, 10'	\$170.20
13222	Extension Cable, 10-pin MP 150, 15'	\$194.62
13223	Extension Cable, 10-pin MP150, 20'	\$233.12
13224	Extension Cable, 10-pin MP 150, 25'	\$274.69
17095	Extension Cable, 10-pin MP 150, 30'	\$324.70
17096	Extension Cable, 10-pin MP 150, 40'	\$390.09
17269	Extension Cable, 10-pin MP 150, 45'	\$428.53
14142	Extension Cable, 10-pin MP 150, 50'	\$506.84

**MP (Metri-Pack) 480 Extension Cables**

18827	Extension Cable, 2-Pin MP 480, 5'	\$140.91
18828	Extension Cable, 2-Pin MP 480, 10'	\$160.96
18436 A	Extension Cable, 2-pin MP 480, 15'	\$175.87
18421 A	Extension Cable, 2-pin MP 480, 20'	\$215.00
18829	Extension Cable, 2-Pin MP 480, 25'	\$217.65

**WP (Weather Pack) Extension Cables**

10450	Extension Cable, 3-pin WP, 5'	\$76.53
10449	Extension Cable, 3-pin WP, 10'	\$85.79
10876	Extension Cable, 3-pin WP, 15'	\$97.81
10829	Extension Cable, 3-pin WP, 20'	\$108.24
11462	Extension Cable, 3-pin WP, 25'	\$118.46

**GT Series Extension Cables**

19313 A	Extension Cable, 16-pin GT, 5'	\$192.77
19314 A	Extension Cable, 16-pin GT, 10'	\$292.45
19315 A	Extension Cable, 16-pin GT, 15'	\$392.41
19316 A	Extension Cable, 16-pin GT, 20'	\$496.33
19317 A	Extension Cable, 16-pin GT, 30'	\$695.98
19318 A	Extension Cable, 16-pin GT, 40'	\$895.51
19319 A	Extension Cable, 16-pin GT, 50'	\$1,095.16

**Replacement Parts**

02011	Magnet Bar Mount, ISOmod™	\$46.84
19170	Fuse Holder Kit	\$72.13
19295	Power Cable, 2-pin MP 480, 30'	\$231.94
19604 A	Bulkhead Harness, Dual ISOmod™, 2'	\$701.25
19605 A	Branch Harness, Dual ISOmod™, Channel 1, 10'	\$328.80
19606 A	Branch Harness, Dual ISOmod™, Channel 2, 10'	\$329.00
19669	Branch Harness, Dual ISOmod™, 6 section, 10'	\$331.00
19670	Branch Harness, Dual ISOmod™, 12 section WPT-PGS, 10'	\$600.00

# ORCHARD/VINEYARD RATE CONTROLLERS

Select from **A B C D E** to build custom systems

## **A** Console with Main Harness

### SprayMate™ XRS

**02027 KIT: included w/ console**

19960 Quick Mount Kit    19958 Control Branch Harness, 15'    12910 Zip Ties    19313 Extension Cable, 5'    19835 Power Cable, 10'    Switches: 21778 Run/Hold, 21779 Power    19959 System Manual

**SprayMate™ XRS**  
 02027 SprayMate™ XRS Customized Kit, 2 section \_\_\_\_\_ \$1,934.80

### RateKing™ XRS

**02021 KIT: included w/ console**

13774 Console Mount Kit    19882 Trailer Harness    19883 Tractor Harness    14315 Power Cable, 15'    19862 System Manual

**RateKing™ XRS**  
 02021 RateKing™ XRS Customized Kit, 4 section \_\_\_\_\_ \$2,748.00

## **B** Speed Sensors

- 01410 Astro™ II GPS Speed Sensor, 3-pin MP (1 Hz) \_\_\_\_\_ \$529.00
- 01425 Astro™ 5 GPS Speed Sensor, 3-pin MP (5 Hz) \_\_\_\_\_ \$707.00
- 01437 Astro™ 5 GPS Speed Sensor, 3-pin MP for Trak-Record II \_\_\_\_\_ \$754.00
- 01530 Wheel Speed Sensor Kit, Hall-effect Magnetic, w/ 10' extension cable, mounting bracket, 6 magnets \_\_\_\_\_ \$249.00
- 01531 Wheel Speed Sensor Kit, Hall-effect Magnetic, w/ 15' extension cable, mounting bracket, 6 magnets \_\_\_\_\_ \$270.00
- 01533 Wheel Speed Sensor Kit, Hall-effect Magnetic, w/ mounting bracket, 6 magnets \_\_\_\_\_ \$136.00
- 01554 RPM Sensor Kit, proximity or gear tooth sensor, w/ 15' extension cable, mounting bracket \_\_\_\_\_ \$389.00

## **C** Flowmeter Kits

### Turbine Type Flowmeter Kits

- 01984 FM250 P Flowmeter Kit, .08-1.6 GPM, 290 PSI, 1/4" NPT and 1/2" HB, IXEF & SS \_\_\_\_\_ \$661.00
- 01500 FM500 Flowmeter Kit, .5-5 GPM, 500 PSI, 1/2" FPT, PP & Hastelloy \_\_\_\_\_ \$520.00
- 01501 FM750 GFN Flowmeter Kit, 2-40 GPM, 150 PSI, 3/4" FPT, nylon & Hastelloy \_\_\_\_\_ \$520.00
- 01504 FM750 SS Flowmeter Kit, 2-40 GPM, 500 PSI, 3/4" FPT, SS & nylon & Hastelloy \_\_\_\_\_ \$936.00
- 01507 FM750 SS Flowmeter Kit, w/ ceramic bearings, 2-40 GPM, 500 PSI, 3/4" FPT \_\_\_\_\_ \$936.00
- 01851 FM750 LF SS Flowmeter Kit, 1-9 GPM, 500 PSI, 3/4" FPT, SS & nylon & Hastelloy \_\_\_\_\_ \$1,059.00
- 01650 FM750 GFN LF Flowmeter Kit, .5-12 GPM, 150 PSI, 3/4" FPT, nylon & Hastelloy \_\_\_\_\_ \$641.00
- 01505 FM1000 SS Flowmeter Kit, 3.5-70 GPM, 500 PSI, 1" FPT, SS & nylon & Hastelloy \_\_\_\_\_ \$1,015.00
- 01515 FM270 Flowmeter Kit, 3.5-70 GPM, 225 PSI, M200 flange, PP, SS, nylon & Hastelloy \_\_\_\_\_ \$852.00
- 01515-P A FM270 P Flowmeter Kit, 3.5-70 GPM, 225 PSI, M200 flange, PP & nylon & Hastelloy \_\_\_\_\_ \$567.00
- 01898 FM270 LF Flowmeter Kit, .5-15 GPM, 225 PSI, M200 flange, PP, SS, & nylon & Hastelloy \_\_\_\_\_ \$914.00
- 01898-P A FM270 P LF Flowmeter Kit, .5-15 GPM, 225 PSI, M200 flange, PP & nylon & Hastelloy \_\_\_\_\_ \$609.00
- 01514 FM10/100 Flowmeter Kit, 10-100 GPM, 225 PSI, M200 flange, SS, PP & nylon & Hastelloy \_\_\_\_\_ \$884.00
- 01514-P A FM10/100 P Flowmeter Kit, 10-100 GPM, 225 PSI, M200 flange, PP & nylon & Hastelloy \_\_\_\_\_ \$588.00
- 01506 FM1500 SS Flowmeter Kit, 10-130 GPM, 500 PSI, 1 1/2" FPT, SS & nylon & Hastelloy \_\_\_\_\_ \$1,335.00
- 01506-P A FM1500 P SS Flowmeter Kit, 10-130 GPM, 500 PSI, 1 1/2" FPT, PP & nylon & Hastelloy \_\_\_\_\_ \$1,007.00
- 01519 FM1500 SS LF Flowmeter Kit, 3.5-70 GPM, 500 PSI, 1 1/2" FPT, SS & nylon & Hastelloy \_\_\_\_\_ \$1,391.00
- 01519-P A FM1500 P SS LF Flowmeter Kit, 3.5-70 GPM, 500 PSI, 1 1/2" FPT, PP & nylon & Hastelloy \_\_\_\_\_ \$1,047.00
- 01511 FM2000 P Flowmeter Kit, 19-198 GPM, 285 PSI, M200 flange, nylon & SS & ceramic \_\_\_\_\_ \$1,539.00
- 01513 FM3000 P Flowmeter Kit, 40-396 GPM, 285 PSI, 3" MPT, nylon & SS & ceramic \_\_\_\_\_ \$2,013.00

## Orchard/Vineyard Rate Controllers

## Electromagnetic Flowmeter Kits

01901	MM2 Flowmeter Kit, .08 to 1.6 GPM, 290 PSI, 3/4" FPT, PP & SS	\$2,148.00
01821	MM3 Flowmeter Kit, .13 to 2.6 GPM, 290 PSI, 3/4" FPT, PP & SS	\$2,148.00
01822	MM5 Flowmeter Kit, .3 to 5 GPM, 290 PSI, 3/4" FPT, PP & SS	\$2,148.00
01823	MM13 Flowmeter Kit, .6 to 13 GPM, 290 PSI, 3/4" FPT, PP & SS	\$2,148.00
01824	MM26 Flowmeter Kit, 1.3 to 26 GPM 290 PSI, 1" FPT, PP & SS	\$2,148.00
01825	MM53 Flowmeter Kit, 2.6 to 53 GPM, 290 PSI, 1" FPT, PP & SS	\$2,148.00
01826	MM106 Flowmeter Kit, 5 to 106 GPM, 290 PSI, 1 1/2" FPT, PP & SS	\$2,148.00
02015	MM106FL Flowmeter Kit, 5 to 106 GPM, 290 PSI, M220 flange, PP & SS	\$2,148.00
01827	MM158 Flowmeter Kit, 8 to 158 GPM, 290 PSI, 2" MPT, PP & SS	\$2,148.00
01749	MM238 Flowmeter Kit, 12 to 238 GPM, 290 PSI, 2" MPT, PP & SS	\$1,439.00
02086 A	MM528 Flowmeter Kit, 26.5 to 528 GPM, 145 PSI, 3" MPT, 3-pin MP-150 Connector, PP & SS	\$1,631.00

## D Flow Control

## Servo Valve (Butterfly) Kits

19093	Servo Valve, 1" butterfly, Viton® o-rings, 150 PSI	\$429.00
19094	Servo Valve, 1" high pressure butterfly, Viton® o-rings, 300 PSI	\$499.00
19095	Servo Valve, 1" butterfly, aqueous ammonia, EPDM o-rings, 150 PSI	\$429.00
19096	Servo Valve, M200 flanged or 1 1/2" FPT, 1" butterfly, Viton® o-rings, 150 PSI	\$600.00
19097	Servo Valve, M200 flanged or 1 1/2" FPT, 1.5" butterfly, Viton® o-rings, 150 PSI, M200	\$600.00
19098	Servo Valve, M200 flanged or 1 1/2" FPT, 1" butterfly, aqua ammonia, EPDM o-rings, 150 PSI	\$600.00
19099	Servo Valve, M200 flanged or 1 1/2" FPT, 1 1/2" butterfly, aqua ammonia, EPDM o-rings, 150 PSI	\$600.00

## EMD - Electric Motor Driver Kits

18008	Electric Motor Driver Kit, STD, 10 Amp	\$569.00
01757	Electric Motor Driver Kit, STD, 40 Amp	\$851.00
18108	Electric Motor Driver Kit, PWM, 10 Amp	\$569.00
01758	Electric Motor Driver Kit, PWM, 40 Amp	\$851.00
01904	Electric Motor Driver Kit, PWM, w/ enable, 10 Amp	\$569.00
01905	Electric Motor Driver Kit, PWM, w/ enable, 40 Amp	\$851.00

## Hydraulic Flow Control Valve Kits

01745	PWM Hydraulic Flow Control Valve w/ Adapter Cable, 8 GPM, SAE 8 ports, 3000 PSI	\$769.00
01864	PWM Hydraulic Flow Control Valve w/ Adapter Cable, 15 GPM, SAE 10 ports, 3000 PSI	\$1,133.00
02066 A	PWM Hydraulic Flow Control Valve w/ Adapter Cable, 25 GPM, SAE 16 ports, 3000 PSI	\$1,714.41
02079 A	PWM Hydraulic Flow Control Valve w/ Adapter Cable, 48 GPM, SAE 20 ports, 3000 PSI	\$1,513.00
13859	Servo Type Hydraulic Flow Control Valve, 5 GPM, 3.5 Second, SAE 8 port, 3000 PSI	\$1,654.00
14885	Servo Type Hydraulic Flow Control Valve, 10 GPM, 3.5 Second, SAE 8 ports, 3000 PSI	\$1,654.00
13857	Servo Type Hydraulic Flow Control Valve, 15 GPM, 3.5 Second, SAE 8 ports, 3000 PSI	\$1,654.00
13860	Servo Type Hydraulic Flow Control Valve, 20 GPM, 3.5 Second, SAE 16 ports, 3000 PSI	\$2,715.00
13858	Servo Type Hydraulic Flow Control Valve, 35 GPM, 3.5 Second, SAE 16 ports, 3000 PSI	\$2,715.00

## Hydraulic Motor/Shutoff Valve Assemblies

17576	Hydraulic Motor/Shutoff Valve Assembly, 4.9 CID, (no sprockets)	\$2,318.00
-------	---	------------

## E Optional Items

18757	Pressure Sensor only, 150 PSI, 4 to 20mA	\$278.54
18758	Pressure Sensor only, 300 PSI, 4 to 20mA	\$278.54
18764	Pressure Harness Kit, single, w/ 15' sensor cable, 10' extension cable	\$149.32

## Replacement Parts - RateKing™ XRS

19883	Tractor Harness, RateKing™ XRS, 5'	\$412.99
19882	Trailer Branch Harness, RateKing™ XRS, 15'	\$837.36
14315 C	Power (battery) Cable, 2-pin WP, 10 Amp fuse, 15'	\$146.20

## Replacement Parts - SprayMate™ XRS

19958 A	Control Branch Harness, SprayMate™ XRS, 15'	\$551.93
14315 C	Power (battery) Cable, 2-pin WP, 10 Amp fuse, 15'	\$146.20

# ANTI-ICE/DE-ICE RATE CONTROL SYSTEMS

Select from **A B C D E** to build custom systems

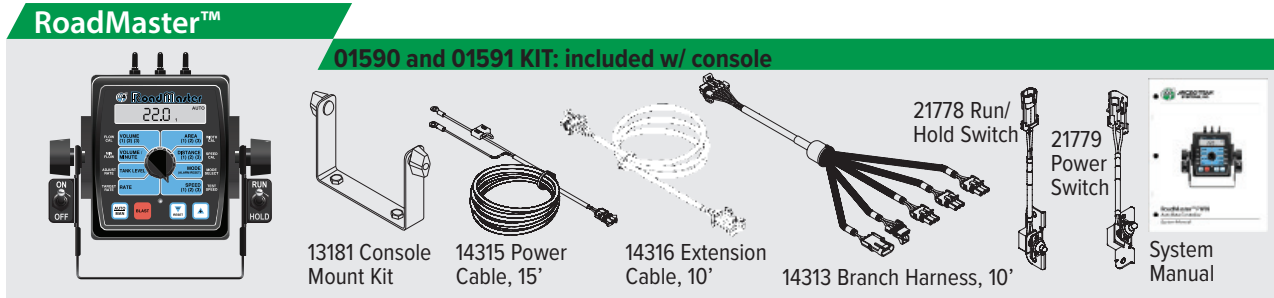

- A** **RoadMaster™**
- |       |   |            |
|-------|---|------------|
| 01590 | RoadMaster™ Customized Kit, STD 12V _____     | \$2,063.00 |
| 01591 | RoadMaster™ Customized Kit, PWM control _____ | \$2,063.00 |

- B** **Speed Sensors**
- |       |   |          |
|-------|---|----------|
| 01410 | Astro™ II GPS Speed Sensor, 3-pin MP (1 Hz) _____   | \$529.00 |
| 01425 | Astro™ 5 GPS Speed Sensor, 3-pin MP (5 Hz) _____  | \$707.00 |
| 01437 | Astro™ 5 GPS Speed Sensor, 3-pin MP for Trak-Record II _____  | \$754.00 |
| 01530 | Wheel Speed Sensor Kit, Hall-effect Magnetic, w/ 10' extension cable, mounting bracket, 6 magnets _ | \$249.00 |
| 01531 | Wheel Speed Sensor Kit, Hall-effect Magnetic, w/ 15' extension cable, mounting bracket, 6 magnets__ | \$270.00 |
| 01533 | Wheel Speed Sensor Kit, Hall-effect Magnetic, w/ mounting bracket, 6 magnets _____                  | \$136.00 |
| 01554 | RPM Sensor Kit, proximity or gear tooth sensor, w/ 15' extension cable, mounting bracket _____      | \$389.00 |

- C** **Flowmeter Kits**
- Turbine Type Flowmeter Kits**
- |           |   |            |
|-----------|---|------------|
| 01984     | FM250 P Flowmeter Kit, .08-1.6 GPM, 290 PSI, 1/4" NPT and 1/2" HB, IXEF & SS _____          | \$661.00   |
| 01500     | FM500 Flowmeter Kit, .5-5 GPM, 500 PSI, 1/2" FPT, PP & Hastelloy _____                      | \$520.00   |
| 01501     | FM750 GFN Flowmeter Kit, 2-40 GPM, 150 PSI, 3/4" FPT, nylon & Hastelloy _____               | \$520.00   |
| 01504     | FM750 SS Flowmeter Kit, 2-40 GPM, 500 PSI, 3/4" FPT, SS & nylon & Hastelloy _____           | \$936.00   |
| 01507     | FM750 SS Flowmeter Kit, w/ ceramic bearings, 2-40 GPM, 500 PSI, 3/4" FPT _____              | \$936.00   |
| 01851     | FM750 LF SS Flowmeter Kit, 1-9 GPM, 500 PSI, 3/4" FPT, SS & nylon & Hastelloy _____         | \$1,059.00 |
| 01650     | FM750 GFN LF Flowmeter Kit, .5-12 GPM, 150 PSI, 3/4" FPT, nylon & Hastelloy _____           | \$641.00   |
| 01505     | FM1000 SS Flowmeter Kit, 3.5-70 GPM, 500 PSI, 1" FPT, SS & nylon & Hastelloy _____          | \$1,015.00 |
| 01515     | FM270 Flowmeter Kit, 3.5-70 GPM, 225 PSI, M200 flange, PP, SS, nylon & Hastelloy _____      | \$852.00   |
| 01515-P A | FM270 P Flowmeter Kit, 3.5-70 GPM, 225 PSI, M200 flange, PP & nylon & Hastelloy _____       | \$567.00   |
| 01898     | FM270 LF Flowmeter Kit, .5-15 GPM, 225 PSI, M200 flange, PP, SS, & nylon & Hastelloy _____  | \$914.00   |
| 01898-P A | FM270 P LF Flowmeter Kit, .5-15 GPM, 225 PSI, M200 flange, PP & nylon & Hastelloy _____     | \$609.00   |
| 01514     | FM10/100 Flowmeter Kit, 10-100 GPM, 225 PSI, M200 flange, SS, PP & nylon & Hastelloy _____  | \$884.00   |
| 01514-P A | FM10/100 P Flowmeter Kit, 10-100 GPM, 225 PSI, M200 flange, PP & nylon & Hastelloy _____    | \$588.00   |
| 01506     | FM1500 SS Flowmeter Kit, 10-130 GPM, 500 PSI, 1 1/2" FPT, SS & nylon & Hastelloy _____      | \$1,335.00 |
| 01506-P A | FM1500 P SS Flowmeter Kit, 10-130 GPM, 500 PSI, 1 1/2" FPT, PP & nylon & Hastelloy _____    | \$1,007.00 |
| 01519     | FM1500 SS LF Flowmeter Kit, 3.5-70 GPM, 500 PSI, 1 1/2" FPT, SS & nylon & Hastelloy _____   | \$1,391.00 |
| 01519-P A | FM1500 P SS LF Flowmeter Kit, 3.5-70 GPM, 500 PSI, 1 1/2" FPT, PP & nylon & Hastelloy _____ | \$1,047.00 |
| 01511     | FM2000 P Flowmeter Kit, 19-198 GPM, 285 PSI, M200 flange, nylon & SS & ceramic _____        | \$1,539.00 |
| 01513     | FM3000 P Flowmeter Kit, 40-396 GPM, 285 PSI, 3" MPT, nylon & SS & ceramic _____             | \$2,013.00 |

- Electromagnetic Flowmeter Kits**
- |         |  |            |
|---------|--|------------|
| 01901   | MM2 Flowmeter Kit, .08 to 1.6 GPM, 290 PSI, 3/4" FPT, PP & SS _____                          | \$2,148.00 |
| 01821   | MM3 Flowmeter Kit, .13 to 2.6 GPM, 290 PSI, 3/4" FPT, PP & SS _____                          | \$2,148.00 |
| 01822   | MM5 Flowmeter Kit, .3 to 5 GPM, 290 PSI, 3/4" FPT, PP & SS _____                             | \$2,148.00 |
| 01823   | MM13 Flowmeter Kit, .6 to 13 GPM, 290 PSI, 3/4" FPT, PP & SS _____                           | \$2,148.00 |
| 01824   | MM26 Flowmeter Kit, 1.3 to 26 GPM 290 PSI, 1" FPT, PP & SS _____                             | \$2,148.00 |
| 01825   | MM53 Flowmeter Kit, 2.6 to 53 GPM, 290 PSI, 1" FPT, PP & SS _____                            | \$2,148.00 |
| 01826   | MM106 Flowmeter Kit, 5 to 106 GPM, 290 PSI, 1 1/2" FPT, PP & SS _____                        | \$2,148.00 |
| 02015   | MM106FL Flowmeter Kit, 5 to 106 GPM, 290 PSI, M220 flange, PP & SS _____                     | \$2,148.00 |
| 01827   | MM158 Flowmeter Kit, 8 to 158 GPM, 290 PSI, 2" MPT, PP & SS _____                            | \$2,148.00 |
| 01749   | MM238 Flowmeter Kit, 12 to 238 GPM, 290 PSI, 2" MPT, PP & SS _____                           | \$1,439.00 |
| 02086 A | MM528 Flowmeter Kit, 26.5 to 528 GPM, 145 PSI, 3" MPT, 3-pin MP-150 Connector, PP & SS _____ | \$1,631.00 |

## D Flow Control

### Servo Valve (Butterfly) Kits

19093	Servo Valve, 1" butterfly, Viton® o-rings, 150 PSI _____	\$429.00
19094	Servo Valve, 1" high pressure butterfly, Viton® o-rings, 300 PSI _____	\$499.00
19095	Servo Valve, 1" butterfly, aqueous ammonia, EPDM o-rings, 150 PSI _____	\$429.00
19096	Servo Valve, M200 flanged or 1 1/2" FPT, 1" butterfly, Viton® o-rings, 150 PSI _____	\$600.00
19097	Servo Valve, M200 flanged or 1 1/2" FPT, 1.5" butterfly, Viton® o-rings, 150 PSI, M200 _____	\$600.00
19098	Servo Valve, M200 flanged or 1 1/2" FPT, 1" butterfly, aqua ammonia, EPDM o-rings, 150 PSI _____	\$600.00
19099	Servo Valve, M200 flanged or 1 1/2" FPT, 1 1/2" butterfly, aqua ammonia, EPDM o-rings, 150 PSI _____	\$600.00

### EMD - Electric Motor Driver Kits

18008	Electric Motor Driver Kit, STD, 10 Amp _____	\$569.00
01757	Electric Motor Driver Kit, STD, 40 Amp _____	\$851.00
18108	Electric Motor Driver Kit, PWM, 10 Amp _____	\$569.00
01758	Electric Motor Driver Kit, PWM, 40 Amp $\text{C} \text{E} \frac{\text{UK}}{\text{CA}}$ _____	\$851.00
01904	Electric Motor Driver Kit, PWM, w/ enable, 10 Amp _____	\$569.00
01905	Electric Motor Driver Kit, PWM, w/ enable, 40 Amp _____	\$851.00

### Hydraulic Flow Control Valve Kits

01745	PWM Hydraulic Flow Control Valve w/ Adapter Cable, 8 GPM, SAE 8 ports, 3000 PSI _____	\$769.00
01864	PWM Hydraulic Flow Control Valve w/ Adapter Cable, 15 GPM, SAE 10 ports, 3000 PSI _____	\$1,133.00
02066 A	PWM Hydraulic Flow Control Valve w/ Adapter Cable, 25 GPM, SAE 16 ports, 3000 PSI _____	\$1,714.41
02079 A	PWM Hydraulic Flow Control Valve w/ Adapter Cable, 48 GPM, SAE 20 ports, 3000 PSI _____	\$1,513.00
13859	Servo Type Hydraulic Flow Control Valve, 5 GPM, 3.5 Second, SAE 8 port, 3000 PSI _____	\$1,654.00
14885	Servo Type Hydraulic Flow Control Valve, 10 GPM, 3.5 Second, SAE 8 ports, 3000 PSI _____	\$1,654.00
13857	Servo Type Hydraulic Flow Control Valve, 15 GPM, 3.5 Second, SAE 8 ports, 3000 PSI _____	\$1,654.00
13860	Servo Type Hydraulic Flow Control Valve, 20 GPM, 3.5 Second, SAE 16 ports, 3000 PSI _____	\$2,715.00
13858	Servo Type Hydraulic Flow Control Valve, 35 GPM, 3.5 Second, SAE 16 ports, 3000 PSI _____	\$2,715.00

### Hydraulic Motor/Shutoff Valve Assemblies

17576	Hydraulic Motor/Shutoff Valve Assembly, 4.9 CID, (no sprockets) _____	\$2,318.00
-------	---	------------

## E Optional Items

18541	Run/Hold Sensor Kit, whisker switch, w/ magnetic mount, 10' extension cable _____	\$366.57
18529 A	Run/Hold Sensor Kit, whisker switch, (no magnetic mount) _____	\$294.92
01535	Run/Hold Sensor Kit, Hall-effect, w/ 2 magnets, 10' extension cable _____	\$211.24
01744	RoadMaster™ Blast/Run/Hold Remote Switch Box, w/ 3-pin MP connector (current) _____	\$246.00
17560	RoadMaster™ Blast/Run/Hold Remote Switch Box, w/ circular connector (old style) _____	\$246.00

### MP (Metri-Pack) 150 Extension Cables

13200	Extension Cable, 2-pin MP 150, 5' _____	\$74.21
13201	Extension Cable, 2-pin MP 150, 10' _____	\$80.11
13202	Extension Cable, 2-pin MP 150, 15' _____	\$86.60
13203	Extension Cable, 2-pin MP 150, 20' _____	\$90.39
13204	Extension Cable, 2-pin MP 150, 25' _____	\$97.80
13205	Extension Cable, 3-pin MP 150, 5' _____	\$82.01
13206	Extension Cable, 3-pin MP 150, 10' _____	\$87.55
13207	Extension Cable, 3-pin MP 150, 15' _____	\$98.43
13208	Extension Cable, 3-pin MP 150, 20' _____	\$104.69
13209	Extension Cable, 3-pin MP 150, 25' _____	\$111.73
13419	Extension Cable, 3-pin MP 150, 50' _____	\$158.70
14363	Extension Cable, 10-pin MP 150, 5-16 & 5-20 gauge, 5' _____	\$150.84
14316	Extension Cable, 10-pin MP 150, 5-16 & 5-20 gauge, 10' _____	\$223.65
14317	Extension Cable, 10-pin MP 150, 5-16 & 5-20 gauge, 15' _____	\$268.87
14364	Extension Cable, 10-pin MP 150, 5-16 & 5-20 gauge, 20' _____	\$330.30
14365	Extension Cable, 10-pin MP 150, 5-16 & 5-20 gauge, 25' _____	\$388.39
14419	Extension Cable, 10-pin MP 150, 5-16 & 5-20 gauge, 50' _____	\$666.77

## Anti-Ice/De-Ice Rate Control Systems

**WP (Weather Pack) Extension Cables**

11560	Extension Cable, 2-pin WP, 5'	\$58.67
11561	Extension Cable, 2-pin WP, 10'	\$68.15
11671	Extension Cable, 2-pin WP, 15'	\$74.14
11672	Extension Cable, 2-pin WP, 20'	\$75.72
10450	Extension Cable, 3-pin WP, 5'	\$76.53
10449	Extension Cable, 3-pin WP, 10'	\$85.79
10876	Extension Cable, 3-pin WP, 15'	\$97.81
10829	Extension Cable, 3-pin WP, 20'	\$108.24
11462	Extension Cable, 3-pin WP, 25'	\$118.46

**Replacement Parts**

17158	Ball Valve Adapter Cable, 3-boom 2-wire, RoadMaster™ & SprayMate II™	\$574.45
14469	Solenoid Adapter Cable, 3-Pin WPS to 1/4" QD	\$34.89
18098	Calibration Lockout Key, set of two, RoadMaster™, SprayMate™ Plus	\$4.68
14313 F	Harness, flow, control, boom, WPT-PGS, SprayMate™ II	\$308.91
14314	Ignition Cable, 72"	\$42.97
14463	*In-Line Servo Valve Adapter Cable, (MT-400™ with S)	\$40.54
14315 C	Power (battery) Cable, 2-pin WP, 10 Amp fuse, 15'	\$146.20
21778	Run/Hold Switch Assembly, SprayMate™ Plus, RoadMaster™, DrillMaster™	\$116.30
21779	Power Switch Assembly for consoles	\$116.29
17523	Remote RoadMaster™ Blast, Run/Hold Cable, w/ mini-din connector	\$73.03
01744	RoadMaster™ Blast/Run/Hold Remote Switch Box, w/ 3-pin MP connector (current)	\$246.00
17560	RoadMaster™ Blast/Run/Hold Remote Switch Box, w/ circular connector (old style)	\$246.00





# GRANULAR RATE CONTROL SYSTEMS

Select from **A B C D E** to build custom systems

GSC-1000™

01402 and 01403 KITS: included w/ console

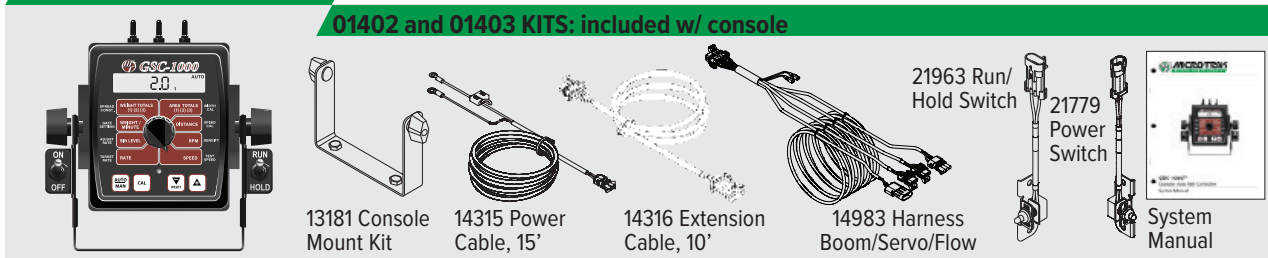

## A GSC-1000™

01402	GSC-1000™ Customized Kit, STD 12V _____	\$1,612.00
01403	GSC-1000™ Customized Kit, PWM _____	\$1,612.00

## B Speed Sensors

01410	Astro™ II GPS Speed Sensor, 3-pin MP (1 Hz) _____	\$529.00
01425	Astro™ 5 GPS Speed Sensor, 3-pin MP (5 Hz) _____	\$707.00
01437	Astro™ 5 GPS Speed Sensor, 3-pin MP for Trak-Record II _____	\$754.00
01530	Wheel Speed Sensor Kit, Hall-effect Magnetic, w/ 10' extension cable, mounting bracket, 6 magnets _____	\$249.00
01531	Wheel Speed Sensor Kit, Hall-effect Magnetic, w/ 15' extension cable, mounting bracket, 6 magnets _____	\$270.00
01533	Wheel Speed Sensor Kit, Hall-effect Magnetic, w/ mounting bracket, 6 magnets _____	\$136.00
01554	RPM Sensor Kit, proximity or gear tooth sensor, w/ 15' extension cable, mounting bracket _____	\$389.00

## C RPM Sensors

01554	RPM Sensor Kit, proximity or gear tooth sensor, w/ 15' extension cable, mounting bracket _____	\$389.00
14471	RPM Sensor Kit, RPM sensor, w/ molded shaft adapter, 6 magnets _____	\$130.64

## D Flow Control

### EMD - Electric Motor Driver Kits

18008	Electric Motor Driver Kit, STD, 10 Amp _____	\$569.00
18108	Electric Motor Driver Kit, PWM, 10 Amp _____	\$569.00
01758	Electric Motor Driver Kit, PWM, 40 Amp <b>CE</b> <b>UL</b> _____	\$804.00
01905	Electric Motor Driver Kit, PWM, w/ enable, 40 Amp _____	\$851.00

### Hydraulic Flow Control Valve Kits

01745	PWM Hydraulic Flow Control Valve w/ Adapter Cable, 8 GPM, SAE 8 ports, 3000 PSI _____	\$769.00
01864	PWM Hydraulic Flow Control Valve w/ Adapter Cable, 15 GPM, SAE 10 ports, 3000 PSI _____	\$1,133.00
02066 A	PWM Hydraulic Flow Control Valve w/ Adapter Cable, 25 GPM, SAE 16 ports, 3000 PSI _____	\$1,714.41
02079 A	PWM Hydraulic Flow Control Valve w/ Adapter Cable, 48 GPM, SAE 20 ports, 3000 PSI _____	\$1,513.00
13859	Servo Type Hydraulic Flow Control Valve, 5 GPM, 3.5 Second, SAE 8 port, 3000 PSI _____	\$1,654.00
14885	Servo Type Hydraulic Flow Control Valve, 10 GPM, 3.5 Second, SAE 8 ports, 3000 PSI _____	\$1,654.00
13857	Servo Type Hydraulic Flow Control Valve, 15 GPM, 3.5 Second, SAE 8 ports, 3000 PSI _____	\$1,654.00
13860	Servo Type Hydraulic Flow Control Valve, 20 GPM, 3.5 Second, SAE 16 ports, 3000 PSI _____	\$2,715.00
13858	Servo Type Hydraulic Flow Control Valve, 35 GPM, 3.5 Second, SAE 16 ports, 3000 PSI _____	\$2,715.00

### Hydraulic Motor/Shutoff Valve Assemblies

17576	Hydraulic Motor/Shutoff Valve Assembly, 4.9 CID, (no sprockets) _____	\$2,318.00
18031	Hydraulic Motor Cross Port Plug (replaces shutoff valve on motor for PWM control) _____	\$96.17

## E Optional Items

01539	RPM Sensor Kit, RPM sensor, w/ mounting bracket, 2 magnets _____	\$141.93
18541	Run/Hold Sensor Kit, whisker switch, w/ magnetic mount, 10' extension cable _____	\$366.57
18529 A	Run/Hold Sensor Kit, whisker switch, (no magnetic mount) _____	\$294.92
01535	Run/Hold Sensor Kit, Hall-effect, w/ 2 magnets, 10' extension cable _____	\$211.24

## Granular Rate Control Systems

## MP (Metri-Pack) 150 Extension Cables

13200	Extension Cable, 2-pin MP 150, 5'	\$74.21
13201	Extension Cable, 2-pin MP 150, 10'	\$80.11
13202	Extension Cable, 2-pin MP 150, 15'	\$86.60
13203	Extension Cable, 2-pin MP 150, 20'	\$90.39
13204	Extension Cable, 2-pin MP 150, 25'	\$97.80
13205	Extension Cable, 3-pin MP 150, 5'	\$82.01
13206	Extension Cable, 3-pin MP 150, 10'	\$87.55
13207	Extension Cable, 3-pin MP 150, 15'	\$98.43
13208	Extension Cable, 3-pin MP 150, 20'	\$104.69
13209	Extension Cable, 3-pin MP 150, 25'	\$111.73
14363	Extension Cable, 10-pin MP 150, 5-16 & 5-20 gauge, 5'	\$150.84
14316	Extension Cable, 10-pin MP 150, 5-16 & 5-20 gauge, 10'	\$223.65
14317	Extension Cable, 10-pin MP 150, 5-16 & 5-20 gauge, 15'	\$268.87
14364	Extension Cable, 10-pin MP 150, 5-16 & 5-20 gauge, 20'	\$330.30
14365	Extension Cable, 10-pin MP 150, 5-16 & 5-20 gauge, 25'	\$388.39

## WP (Weather Pack) Extension Cables

10450	Extension Cable, 3-pin WP, 5'	\$76.53
10449	Extension Cable, 3-pin WP, 10'	\$85.79
10876	Extension Cable, 3-pin WP, 15'	\$97.81
10829	Extension Cable, 3-pin WP, 20'	\$108.24
11462	Extension Cable, 3-pin WP, 25'	\$118.46

## Replacement Parts

14983	Harness Branch, servo, flow, RPM	\$279.83
14315 C	Power (battery) Cable, 2-pin WP, 10 Amp fuse, 15'	\$146.20
14536	Molded Shaft Adapter Kit, w/ 10 magnets	\$78.00
14471	RPM Sensor Kit, RPM sensor, w/ molded shaft adapter, 6 magnets	\$130.64
21779	Power Switch Assembly for consoles	\$116.29
21963	Run/Hold Switch Assembly, SprayMate™ II, MT-NH3™ II, GSC-1000™	\$116.29

# LIFT-N-GO

## DOLLY CRANKING MADE EASY

Dolly cranking is made easy with Lift-n-Go. This innovative system seamlessly integrates with the air leveling system of your semi tractor to lift the tractor rail, along with the weight of the trailer automatically. Just engage the parking brake and activate Lift-n-Go. You can now effortlessly crank up the dolly legs, disengage the parking brake and hit the road!

## Lift-N-Go

## Lift-N-Go KIT: included

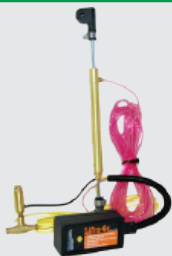

## Lift-N-Go

17674	Lift-N-Go Kit, control box, air cylinder, brass T fitting, 30' air hose, accessory bag	\$562.58
	Quantity Pricing: 50 or more Lift-N-Go Kits	\$506.32

# PLANTING & SEEDING CONTROLLERS

## ProPlant™

### 01204 KIT: included w/ console

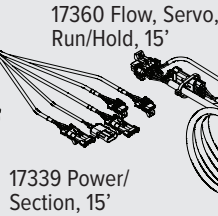
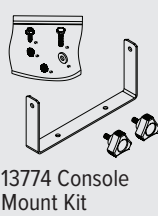

### ProPlant™ Seed Rate Controller

01204 ProPlant™ Console Kit \_\_\_\_\_ \$1,987.00

#### Harness Kits

01200 ProPlant™ Single Section Mounted Harness Kit \_\_\_\_\_ \$197.00

01202 ProPlant™ Multiple Drive Mounted Harness Kit \_\_\_\_\_ \$287.00

01201 ProPlant™ Single Section Drawn Harness Kit, w/ 25' extension cable \_\_\_\_\_ \$463.00

01203 ProPlant™ Multiple Drive Drawn Harness Kit, w/ 25' extension cable \_\_\_\_\_ \$556.00

## DrillMaster™

### 01682 KIT: included w/ console

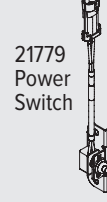
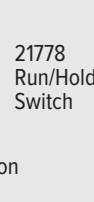
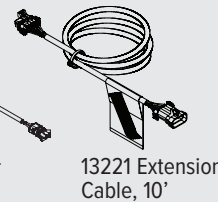
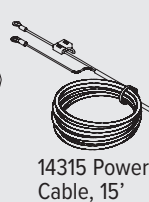
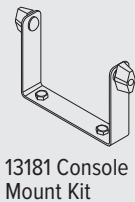

### DrillMaster™

01682 DrillMaster™ Console Kit \_\_\_\_\_ \$1,444.00

#### Harness Kits

01680 DrillMaster™ Mounted Harness Kit, 1 section, w/ 15' extension cable \_\_\_\_\_ \$195.00

01691 DrillMaster™ Drawn Kit, 2 section, w/ 40' extension cable \_\_\_\_\_ \$1,082.00

01684 DrillMaster™ Drawn Kit, 3 section, w/ 40' extension cable \_\_\_\_\_ \$1,206.00

### Select 1 Primary and as Many Secondary Drive Assemblies as Needed from Below

#### Primary Drive (Select One)

01209 Hydraulic Drive Kit, primary, 4.9 CID, #40 3/4" \_\_\_\_\_ \$4,002.00

01211 Hydraulic Drive Kit, primary, 4.9 CID, #40 7/8" \_\_\_\_\_ \$4,002.00

#### Secondary Drive (Select Qty. Required for Multi-Section Systems)

01210 Hydraulic Drive Kit, secondary, 4.9 CID, #40 3/4" \_\_\_\_\_ \$4,002.00

01212 Hydraulic Drive Kit, secondary, 4.9 CID, #40 7/8" \_\_\_\_\_ \$4,002.00

#### Hydraulic Flow Control Valve Kits (Select One)

13859 Servo Type Hydraulic Flow Control Valve, 5 GPM, 3.5 Second, SAE 8 port, 3000 PSI \_\_\_\_\_ \$1,654.00

14885 Servo Type Hydraulic Flow Control Valve, 10 GPM, 3.5 Second, SAE 8 ports, 3000 PSI \_\_\_\_\_ \$1,654.00

#### Speed Sensors (Select One)

01410 Astro™ II GPS Speed Sensor, 3-pin MP (1 Hz) \_\_\_\_\_ \$529.00

01425 Astro™ 5 GPS Speed Sensor, 3-pin MP (5 Hz) \_\_\_\_\_ \$707.00

01554 RPM Sensor Kit, proximity or gear tooth sensor, w/ 15' extension cable, mounting bracket \_\_\_\_\_ \$389.00

#### Optional Items

17370 ProPlant™ Variable Rate Token, green \_\_\_\_\_ \$240.60

18541 Run/Hold Sensor Kit, whisker switch, w/ magnetic mount, 10' extension cable \_\_\_\_\_ \$366.57

18529 A Run/Hold Sensor Kit, whisker switch, (no magnetic mount) \_\_\_\_\_ \$294.92

# CUSTOMIZED NH3 RATE CONTROLLER

Select from **A B C D** to build custom systems

## **A** Console with Main Harness

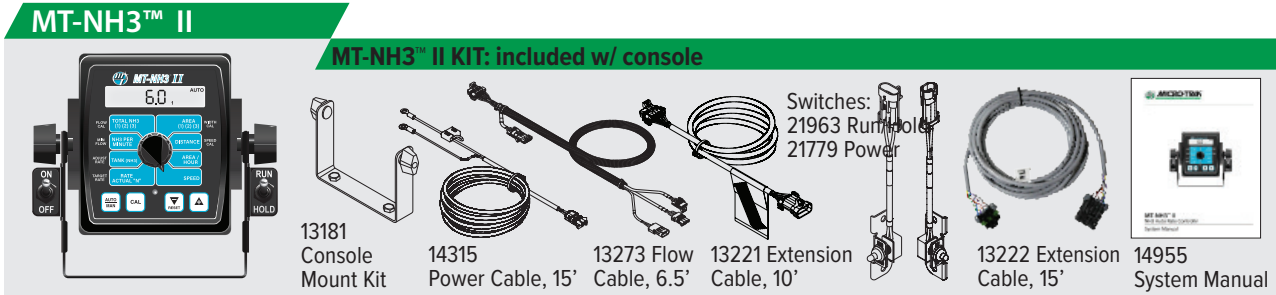

01144 MT-NH3™ II Console Kit for NH3, (requires Liquifier Kit) \_\_\_\_\_ \$1,534.00

## **B** Speed Sensors

- 01410 Astro™ II GPS Speed Sensor, 3-pin MP (1 Hz) \_\_\_\_\_ \$529.00
- 01425 Astro™ 5 GPS Speed Sensor, 3-pin MP (5 Hz) \_\_\_\_\_ \$707.00
- 01437 Astro™ 5 GPS Speed Sensor, 3-pin MP for Trak-Record II \_\_\_\_\_ \$754.00
- 01530 Wheel Speed Sensor Kit, Hall-effect Magnetic, w/ 10' extension cable, mounting bracket, 6 magnets \_ \$249.00
- 01531 Wheel Speed Sensor Kit, Hall-effect Magnetic, w/ 15' extension cable, mounting bracket, 6 magnets\_\_ \$270.00
- 01533 Wheel Speed Sensor Kit, Hall-effect Magnetic, w/ mounting bracket, 6 magnets \_\_\_\_\_ \$136.00
- 01554 RPM Sensor Kit, proximity or gear tooth sensor, w/ 15' extension cable, mounting bracket \_\_\_\_\_ \$389.00

## **C** NH3 Kits

**NH3 Application - Liquifier Kits (Liquifier kits come with one master shutoff valve, additional valves may be added)**

- 01815 Liquifier Junior Ultra-Low Rate NH3 Kit, 600-2800 lbs. (272-1270 kg) NH3/hour \_\_\_\_\_ \$5,067.00
- 01816 Liquifier Junior NH3 Kit, 1000-6000 lbs. (453-2722 kg) NH3/hour \_\_\_\_\_ \$5,067.00
- 01817 Liquifier NH3 Kit, 1500-12000 lbs. (680-5443 kg) NH3/hour \_\_\_\_\_ \$6,760.00
- 01818 Liquifier Max Kit, 3100-21000 lbs. (1406-9525 kg) NH3/hour \_\_\_\_\_ \$15,004.00
- 17972 A KZValve® NH3 Shutoff Valve, 1" \_\_\_\_\_ \$1,428.59

(When P/N 17972 is ordered for section control, the net price per valve is \$580.00)

### NH3 Plumbing Panel Retrofit Kits

Includes Strainer (2 for MAX), cooler (2 for MAX), Y-pipe (MAX), vapor tubes and hoses, mounting bracket and hardware.

**Note: flowmeter, control valve or shutoff valves are not included.**

- 01772 Liquifier Cooler Retro Kit \_\_\_\_\_ \$3,251.00
- 01775 Liquifier Max Cooler Retro Kit \_\_\_\_\_ \$8,296.00

## **D** Optional Items

### MP (Metri-Pack) 150 Extension Cables

- 13205 Extension Cable, 3-pin MP 150, 5' \_\_\_\_\_ \$82.01
- 13206 Extension Cable, 3-pin MP 150, 10' \_\_\_\_\_ \$87.55
- 13207 Extension Cable, 3-pin MP 150, 15' \_\_\_\_\_ \$98.43
- 13208 Extension Cable, 3-pin MP 150, 20' \_\_\_\_\_ \$104.69
- 13209 Extension Cable, 3-pin MP 150, 25' \_\_\_\_\_ \$111.73
- 13220 Extension Cable, 10-pin MP 150, 5' \_\_\_\_\_ \$142.53
- 13221 Extension Cable, 10-pin MP 150, 10' \_\_\_\_\_ \$170.20
- 13222 Extension Cable, 10-pin MP 150, 15' \_\_\_\_\_ \$194.62
- 13223 Extension Cable, 10-pin MP150, 20' \_\_\_\_\_ \$233.12
- 13224 Extension Cable, 10-pin MP 150, 25' \_\_\_\_\_ \$274.69
- 14142 Extension Cable, 10-pin MP 150, 50' \_\_\_\_\_ \$506.84

### WP (Weather Pack) Extension Cables

- 10450 Extension Cable, 3-pin WP, 5' \_\_\_\_\_ \$76.53
- 10449 Extension Cable, 3-pin WP, 10' \_\_\_\_\_ \$85.79
- 10876 Extension Cable, 3-pin WP, 15' \_\_\_\_\_ \$97.81
- 10829 Extension Cable, 3-pin WP, 20' \_\_\_\_\_ \$108.24
- 11462 Extension Cable, 3-pin WP, 25' \_\_\_\_\_ \$118.46



*Customized NH3 Rate Controller*

**Replacement Parts**

13620	Power Cable, 2-pin MP, MT-NH3™, 10'	\$54.37
13348	Pin, Quick Release Switchbox, SS	\$36.66
17858	Suction Cup Mounting Kit for Console	\$178.00
18767	Adapter Cable, power/master switch, MT-NH3™	\$80.55
21963	Switch Assembly, run/hold, SprayMate™ II, MT-NH3™ II, GSC-1000™	\$116.29
21779	Power Switch Assembly for consoles	\$116.29



# NH<sub>3</sub> APPLICATION

LIQUIFIER™ ULTRA LOW-RATE	LIQUIFIER™ JUNIOR	LIQUIFIER™	LIQUIFIER™ MAX
			
2800 lbs. NH <sub>3</sub> /hr. 11 GPM(@100 PSI)	6000 lbs. NH <sub>3</sub> /hr. 23 GPM(@100 PSI)	12000 lbs. NH <sub>3</sub> /hr. 40 GPM(@100 PSI)	21000 lbs. NH <sub>3</sub> /hr. 70 GPM(@100 PSI)
<b>01815 Included in the Kit:</b> Mounting Brackets 18307 Strainer 19797 Flowmeter 17392 Flow Sensor Cable, 10" 19101 Servo Valve 17972 Shut-off Valve 18465 Heat Exchanger	<b>01816 Included in the Kit:</b> Mounting Brackets 18307 Strainer 10899 Flowmeter 17392 Flow Sensor Cable, 10" 19102 Servo Valve 17972 Shut-off Valve 18555 Heat Exchanger 11024 & 11025 Tubing	<b>01817 Included in the Kit:</b> Mounting Brackets 18184 Strainer 19799 Flowmeter 17392 Flow Sensor Cable, 10" 18187 Servo Valve 17972 Shut-off Valve 18183 Heat Exchanger 11024 & 11025 Tubing	<b>01818 Included in the Kit:</b> Mounting Brackets 18184 Strainer 19798 Flowmeter 17392 Flow Sensor Cable, 10" 18185 Servo Valve 18186 Shut-off 18183 Heat Exchanger 11024 & 11025 Tubing

**MICRO-TRAK® LIQUIFIERS ARE ALL ASSEMBLED AND PRESSURE TESTED**

## Liquifier kits

(Liquifier kits come with one master shutoff valve, additional valves may be added)

01815	Liquifier Junior Ultra-Low Rate NH <sub>3</sub> Kit, 600-2800 lbs. (272-1270 kg) NH <sub>3</sub> /hour _____	\$5,067.00
01816	Liquifier Junior NH <sub>3</sub> Kit, 1000-6000 lbs. (453-2722 kg) NH <sub>3</sub> /hour _____	\$5,067.00
01817	Liquifier NH <sub>3</sub> Kit, 1500-12000 lbs. (680-5443 kg) NH <sub>3</sub> /hour _____	\$6,760.00
01818	Liquifier Max Kit, 3100-21000 lbs. (1406-9525 kg) NH <sub>3</sub> /hour _____	\$15,004.00
17972 A	KZValve® NH <sub>3</sub> Shutoff Valve, 1" _____	\$1,428.59

(When P/N 17972 is ordered for section control, the net price per valve is \$580.00)

## NH<sub>3</sub> Plumbing Panel Retrofit kits

Includes Strainer (2 for MAX), cooler (2 for MAX), Y-pipe (MAX), vapor tubes and hoses, mounting bracket and hardware.

Note: flowmeter, control valve or shutoff valves are not included.

01772	Liquifier Cooler Retro Kit _____	\$3,251.00
01775	Liquifier Max Cooler Retro Kit _____	\$8,296.00

## DirectConnect™ for NH<sub>3</sub>

Note: the following kits are harnesses only - choose NH<sub>3</sub> Liquifier kit above.

### John Deere®

01828	DirectConnect™ Harness Kit for GreenStar™ Rate Controller, NH <sub>3</sub> , 1 section, 37-pin AMP CPC _____	\$743.00
01829	DirectConnect™ Harness Kit for GreenStar™ Rate Controller, NH <sub>3</sub> , 1-6 sections _____	\$1,010.00
01830	DirectConnect™ Harness Kit for GreenStar™ Rate Controller, NH <sub>3</sub> , 1-10 sections _____	\$1,241.00
18458	DirectConnect™ Master/Relief/Agitation Cable for GreenStar™ Rate Controller, NH <sub>3</sub> _____	\$258.00

### Trimble®

18328	DirectConnect™ Harness Kit for Trimble® Field IQ™, 1 section, NH <sub>3</sub> , 7' _____	\$427.00
19721	DirectConnect™ Harness Kit for Trimble® Field IQ™, 1-6 sections, NH <sub>3</sub> , 7' _____	\$861.00

### Raven

01596	DirectConnect™ Harness Kit for Raven 440/450, 1 section, NH <sub>3</sub> _____	\$748.00
01597	DirectConnect™ Harness Kit for Raven 440/450, 5 section, NH <sub>3</sub> _____	\$1,029.00

### AgLeader®

01586	DirectConnect™ Harness Kit for AgLeader® DirectCommand®, 1 section, NH <sub>3</sub> _____	\$774.00
01587	DirectConnect™ Harness Kit for AgLeader® DirectCommand®, 5 sections, NH <sub>3</sub> _____	\$1,538.00

## Direct Connect™ Auto Section Control Adapters

### TeeJet® Centerline 230BP and BoomPilot®

17891	DirectConnect™ T-Adapter for TeeJet® 230 BP/BoomPilot® _____	\$537.00
19727	DirectConnect™ Adapter Cable, TeeJet® ASC to RateKing™ _____	\$537.00

# DIRECTCONNECT™ LIQUID CONTROL SYSTEMS

Select from **A** **B** **C** to build custom systems



## Main Harness Kits

### John Deere®

01828	DirectConnect™ Harness Kit for GreenStar™ Rate Controller, liquid, 1 section, 37-pin AMP CPC	\$743.00
01829	DirectConnect™ Harness Kit for GreenStar™ Rate Controller, liquid, 1-6 sections	\$1,010.00
01830	DirectConnect™ Harness Kit for GreenStar™ Rate Controller, liquid, 1-10 sections	\$1,241.00
18458	DirectConnect™ Master/Relief/Agitation Cable for GreenStar™ Rate Controller, liquid	\$258.00

### Trimble®

17627	DirectConnect™ Harness Kit for Trimble® EZ Boom™ 2010, liquid, 1-7 section	\$1,081.00
18328	DirectConnect™ Harness Kit for Trimble® Field IQ™, liquid, 1 section, 7'	\$427.00
18349	DirectConnect™ Trimble® Field IQ™ Harness Kit, liquid, 1-6 sections, 7'	\$726.00
18350	*DirectConnect™ Trimble® Field IQ™, Harness Kit, liquid, 1-12 sections, 7'	\$932.00

### Raven

17628	DirectConnect™ Harness Kit for Raven 440/450, liquid	\$1,081.00
-------	--	------------

### AgLeader®

01651	DirectConnect™ Harness Kit for AgLeader® DirectCommand®, liquid	\$506.00
-------	---	----------

### Case IH®

18294 D	DirectConnect™ Liquid Fertilizer Cable for Case IH® AFS Pro 600/700, liquid, 10'	\$270.00
---------	--	----------



## Flowmeter Kits

### Turbine Type Flowmeter Kits

01984	FM250 P Flowmeter Kit, .08-1.6 GPM, 290 PSI, 1/4" NPT and 1/2" HB, IXEF & SS	\$661.00
01500	FM500 Flowmeter Kit, .5-5 GPM, 500 PSI, 1/2" FPT, PP & Hastelloy	\$520.00
01501	FM750 GFN Flowmeter Kit, 2-40 GPM, 150 PSI, 3/4" FPT, nylon & Hastelloy	\$520.00
01504	FM750 SS Flowmeter Kit, 2-40 GPM, 500 PSI, 3/4" FPT, SS & nylon & Hastelloy	\$936.00
01507	FM750 SS Flowmeter Kit, w/ ceramic bearings, 2-40 GPM, 500 PSI, 3/4" FPT	\$936.00
01851	FM750 LF SS Flowmeter Kit, 1-9 GPM, 500 PSI, 3/4" FPT, SS & nylon & Hastelloy	\$1,059.00
01650	FM750 GFN LF Flowmeter Kit, .5-12 GPM, 150 PSI, 3/4" FPT, nylon & Hastelloy	\$641.00
01505	FM1000 SS Flowmeter Kit, 3.5-70 GPM, 500 PSI, 1" FPT, SS & nylon & Hastelloy	\$1,015.00
01515	FM270 Flowmeter Kit, 3.5-70 GPM, 225 PSI, M200 flange, PP, SS, nylon & Hastelloy	\$852.00
01515-P A	FM270 P Flowmeter Kit, 3.5-70 GPM, 225 PSI, M200 flange, PP & nylon & Hastelloy	\$567.00
01898	FM270 LF Flowmeter Kit, .5-15 GPM, 225 PSI, M200 flange, PP, SS, & nylon & Hastelloy	\$914.00
01898-P A	FM270 P LF Flowmeter Kit, .5-15 GPM, 225 PSI, M200 flange, PP & nylon & Hastelloy	\$609.00
01514	FM10/100 Flowmeter Kit, 10-100 GPM, 225 PSI, M200 flange, SS, PP & nylon & Hastelloy	\$884.00
01514-P A	FM10/100 P Flowmeter Kit, 10-100 GPM, 225 PSI, M200 flange, PP & nylon & Hastelloy	\$588.00
01506	FM1500 SS Flowmeter Kit, 10-130 GPM, 500 PSI, 1 1/2" FPT, SS & nylon & Hastelloy	\$1,335.00
01506-P A	FM1500 P SS Flowmeter Kit, 10-130 GPM, 500 PSI, 1 1/2" FPT, PP & nylon & Hastelloy	\$1,007.00
01519	FM1500 SS LF Flowmeter Kit, 3.5-70 GPM, 500 PSI, 1 1/2" FPT, SS & nylon & Hastelloy	\$1,391.00
01519-P A	FM1500 P SS LF Flowmeter Kit, 3.5-70 GPM, 500 PSI, 1 1/2" FPT, PP & nylon & Hastelloy	\$1,047.00
01511	FM2000 P Flowmeter Kit, 19-198 GPM, 285 PSI, M200 flange, nylon & SS & ceramic	\$1,539.00
01513	FM3000 P Flowmeter Kit, 40-396 GPM, 285 PSI, 3" MPT, nylon & SS & ceramic	\$2,013.00

### Electromagnetic Flowmeter Kits

01901	MM2 Flowmeter Kit, .08 to 1.6 GPM, 290 PSI, 3/4" FPT, PP & SS	\$2,148.00
01821	MM3 Flowmeter Kit, .13 to 2.6 GPM, 290 PSI, 3/4" FPT, PP & SS	\$2,148.00
01822	MM5 Flowmeter Kit, .3 to 5 GPM, 290 PSI, 3/4" FPT, PP & SS	\$2,148.00
01823	MM13 Flowmeter Kit, .6 to 13 GPM, 290 PSI, 3/4" FPT, PP & SS	\$2,148.00
01824	MM26 Flowmeter Kit, 1.3 to 26 GPM 290 PSI, 1" FPT, PP & SS	\$2,148.00
01825	MM53 Flowmeter Kit, 2.6 to 53 GPM, 290 PSI, 1" FPT, PP & SS	\$2,148.00
01826	MM106 Flowmeter Kit, 5 to 106 GPM, 290 PSI, 1 1/2" FPT, PP & SS	\$2,148.00
02015	MM106FL Flowmeter Kit, 5 to 106 GPM, 290 PSI, M220 flange, PP & SS	\$2,148.00
01827	MM158 Flowmeter Kit, 8 to 158 GPM, 290 PSI, 2" MPT, PP & SS	\$2,148.00
01749	MM238 Flowmeter Kit, 12 to 238 GPM, 290 PSI, 2" MPT, PP & SS	\$1,439.00
02086 A	MM528 Flowmeter Kit, 26.5 to 528 GPM, 145 PSI, 3" MPT, 3-pin MP-150 Connector, PP & SS	\$1,631.00

# C Flow Control

## Servo Valve (Butterfly) Kits

19093	Servo Valve, 1" butterfly, Viton® o-rings, 150 PSI _____	\$429.00
19094	Servo Valve, 1" high pressure butterfly, Viton® o-rings, 300 PSI _____	\$499.00
19095	Servo Valve, 1" butterfly, aqueous ammonia, EPDM o-rings, 150 PSI _____	\$429.00
19096	Servo Valve, M200 flanged or 1 1/2" FPT, 1" butterfly, Viton® o-rings, 150 PSI _____	\$600.00
19097	Servo Valve, M200 flanged or 1 1/2" FPT, 1.5" butterfly, Viton® o-rings, 150 PSI, M200 _____	\$600.00
19098	Servo Valve, M200 flanged or 1 1/2" FPT, 1" butterfly, aqua ammonia, EPDM o-rings, 150 PSI _____	\$600.00
19099	Servo Valve, M200 flanged or 1 1/2" FPT, 1 1/2" butterfly, aqua ammonia, EPDM o-rings, 150 PSI _____	\$600.00

## EMD - Electric Motor Driver Kits

18008	Electric Motor Driver Kit, STD, 10 Amp _____	\$569.00
01757	Electric Motor Driver Kit, STD, 40 Amp _____	\$851.00
18108	Electric Motor Driver Kit, PWM, 10 Amp _____	\$569.00
01758	Electric Motor Driver Kit, PWM, 40 Amp  _____	\$851.00
01904	Electric Motor Driver Kit, PWM, w/ enable, 10 Amp _____	\$569.00
01905	Electric Motor Driver Kit, PWM, w/ enable, 40 Amp _____	\$851.00

## Hydraulic Flow Control Valve Kits











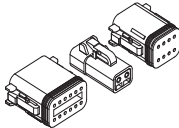

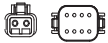
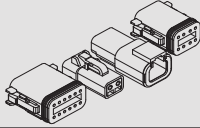
01745	PWM Hydraulic Flow Control Valve w/ Adapter Cable, 8 GPM, SAE 8 ports, 3000 PSI _____	\$769.00
01864	PWM Hydraulic Flow Control Valve w/ Adapter Cable, 15 GPM, SAE 10 ports, 3000 PSI _____	\$1,133.00
02066 A	PWM Hydraulic Flow Control Valve w/ Adapter Cable, 25 GPM, SAE 16 ports, 3000 PSI _____	\$1,714.41
02079 A	PWM Hydraulic Flow Control Valve w/ Adapter Cable, 48 GPM, SAE 20 ports, 3000 PSI _____	\$1,513.00
13859	Servo Type Hydraulic Flow Control Valve, 5 GPM, 3.5 Second, SAE 8 port, 3000 PSI _____	\$1,654.00
14885	Servo Type Hydraulic Flow Control Valve, 10 GPM, 3.5 Second, SAE 8 ports, 3000 PSI _____	\$1,654.00
13857	Servo Type Hydraulic Flow Control Valve, 15 GPM, 3.5 Second, SAE 8 ports, 3000 PSI _____	\$1,654.00
13860	Servo Type Hydraulic Flow Control Valve, 20 GPM, 3.5 Second, SAE 16 ports, 3000 PSI _____	\$2,715.00
13858	Servo Type Hydraulic Flow Control Valve, 35 GPM, 3.5 Second, SAE 16 ports, 3000 PSI _____	\$2,715.00

## Hydraulic Motor/Shutoff Valve Assemblies

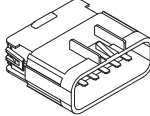
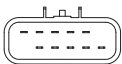
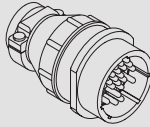
17576	Hydraulic Motor/Shutoff Valve Assembly, 4.9 CID, (no sprockets) _____	\$2,318.00
-------	---	------------

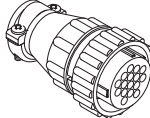
## Optional Items

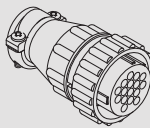
18541	Run/Hold Sensor Kit, whisker switch, w/ magnetic mount, 10' extension cable _____	\$366.57
18529 A	Run/Hold Sensor Kit, whisker switch, (no magnetic mount) _____	\$294.92

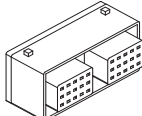
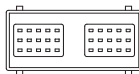
Console	Kit Number	Connector(s)		
<b>Ag Leader®</b> DirectCommand™ Liquid Control	<b>01651</b>	Deutsch® DT-06 12-Pin Deutsch® DT-06 8-Pin Deutsch® DTP-06 2-Pin		 
<b>Ag Leader®</b> DirectCommand™ NH3 Control	<b>01586 - 1 Section</b> <b>01587 - 5 Section</b>	Deutsch® DT-06 12-Pin Deutsch® DT-06 8-Pin Deutsch® DTP-04 2-Pin Deutsch® DTP-06 2-Pin		  
<b>Case®</b> AFS™ Pro 600 & 700 Liquid Control	<b>18294</b>	Delphi® GT-280 12-pin		
<b>John Deere®</b> GreenStar™ Liquid & NH3 Control	<b>01828 - 1 Section</b> <b>01829 - 6 Section</b> <b>01830 - 10 Section</b>	AMP® CPC 37-pin		
<b>Raven®</b> SCS 440™ & 450™ Liquid & NH3 Control	<b>17628 - Liquid</b> <b>01596 - NH3 1 Section</b> <b>01597 - NH3 5 Section</b>	AMP® CPC 16-pin		
<b>Trimble®</b> EZ-Boom™ 2010 Liquid	<b>17627 - Liquid</b>	AMP® CPC 16-pin		
<b>Trimble®</b> Field-IQ™ Liquid & NH3 Control	<b>18328 - Liq. or NH3 1 Section</b> <b>18349 - Liq. or NH3 6 Section</b>	Cinch® SHS 30-pin		



# ACCESSORIES

## SPEED SENSORS

### Speed Sensors for Micro-Trak's Current Line of Products

01410	Astro™ II GPS Speed Sensor, 3-pin MP (1 Hz)	\$529.00
01425	Astro™ 5 GPS Speed Sensor, 3-pin MP (5 Hz)	\$707.00
01437	Astro™ 5 GPS Speed Sensor, 3-pin MP for Trak-Record II	\$754.00
01526	Vansco® Radar Speed Sensor with Gen. II adapter Cable	\$1,262.03
01527	Vansco® Radar Speed Sensor with Gen. I adapter cable	\$1,262.03
01528	Vansco Radar Speed Sensor with 4-pin AMP connector	\$1,233.03
01530	Wheel Speed Sensor Kit, Hall-effect Magnetic, w/ 10' extension cable, mounting bracket, 6 magnets	\$249.00
01531	Wheel Speed Sensor Kit, Hall-effect Magnetic, w/ 15' extension cable, mounting bracket, 6 magnets	\$270.00
01533	Wheel Speed Sensor Kit, Hall-effect Magnetic, w/ mounting bracket, 6 magnets	\$136.00
01554	RPM Sensor Kit, proximity or gear tooth sensor, w/ 15' extension cable, mounting bracket	\$389.00

## FLOWMETERS

### Turbine Type Flowmeter Kits

01984	FM250 P Flowmeter Kit, .08-1.6 GPM, 290 PSI, 1/4" NPT and 1/2" HB, IXEF & SS	\$661.00
01500	FM500 Flowmeter Kit, .5-5 GPM, 500 PSI, 1/2" FPT, PP & Hastelloy	\$520.00
01501	FM750 GFN Flowmeter Kit, 2-40 GPM, 150 PSI, 3/4" FPT, nylon & Hastelloy	\$520.00
01504	FM750 SS Flowmeter Kit, 2-40 GPM, 500 PSI, 3/4" FPT, SS & nylon & Hastelloy	\$936.00
01507	FM750 SS Flowmeter Kit, w/ ceramic bearings, 2-40 GPM, 500 PSI, 3/4" FPT	\$936.00
01687	FM750 GFN Flowmeter Kit, w/ reed flow sensor, 2-40 GPM, 150 PSI, 3/4" FPT, nylon & Hastelloy	\$468.00
01851	FM750 LF SS Flowmeter Kit, 1-9 GPM, 500 PSI, 3/4" FPT, SS & nylon & Hastelloy	\$1,059.00
01650	FM750 GFN LF Flowmeter Kit, .5-12 GPM, 150 PSI, 3/4" FPT, nylon & Hastelloy	\$641.00
01505	FM1000 SS Flowmeter Kit, 3.5-70 GPM, 500 PSI, 1" FPT, SS & nylon & Hastelloy	\$1,015.00
01515	FM270 Flowmeter Kit, 3.5-70 GPM, 225 PSI, M200 flange, PP, SS, nylon & Hastelloy	\$852.00
01515-P A	FM270 P Flowmeter Kit, 3.5-70 GPM, 225 PSI, M200 flange, PP & nylon & Hastelloy	\$567.00
01898	FM270 LF Flowmeter Kit, .5-15 GPM, 225 PSI, M200 flange, PP, SS, & nylon & Hastelloy	\$914.00
01898-P A	FM270 P LF Flowmeter Kit, .5-15 GPM, 225 PSI, M200 flange, PP & nylon & Hastelloy	\$609.00
01514	FM10/100 Flowmeter Kit, 10-100 GPM, 225 PSI, M200 flange, SS, PP & nylon & Hastelloy	\$884.00
01514-P A	FM10/100 P Flowmeter Kit, 10-100 GPM, 225 PSI, M200 flange, PP & nylon & Hastelloy	\$588.00
01506	FM1500 SS Flowmeter Kit, 10-130 GPM, 500 PSI, 1 1/2" FPT, SS & nylon & Hastelloy	\$1,335.00
01506-P A	FM1500 P SS Flowmeter Kit, 10-130 GPM, 500 PSI, 1 1/2" FPT, PP & nylon & Hastelloy	\$1,007.00
01519	FM1500 SS LF Flowmeter Kit, 3.5-70 GPM, 500 PSI, 1 1/2" FPT, SS & nylon & Hastelloy	\$1,391.00
01519-P A	FM1500 P SS LF Flowmeter Kit, 3.5-70 GPM, 500 PSI, 1 1/2" FPT, PP & nylon & Hastelloy	\$1,047.00
01511	FM2000 P Flowmeter Kit, 19-198 GPM, 285 PSI, M200 flange, nylon & SS & ceramic	\$1,539.00
01513	FM3000 P Flowmeter Kit, 40-396 GPM, 285 PSI, 3" MPT, nylon & SS & ceramic	\$2,013.00

### Electromagnetic Flowmeter Kits

01901	MM2 Flowmeter Kit, .08 to 1.6 GPM, 290 PSI, 3/4" FPT, PP & SS	\$2,148.00
01821	MM3 Flowmeter Kit, .13 to 2.6 GPM, 290 PSI, 3/4" FPT, PP & SS	\$2,148.00
01822	MM5 Flowmeter Kit, .3 to 5 GPM, 290 PSI, 3/4" FPT, PP & SS	\$2,148.00
01823	MM13 Flowmeter Kit, .6 to 13 GPM, 290 PSI, 3/4" FPT, PP & SS	\$2,148.00
01824	MM26 Flowmeter Kit, 1.3 to 26 GPM 290 PSI, 1" FPT, PP & SS	\$2,148.00
01825	MM53 Flowmeter Kit, 2.6 to 53 GPM, 290 PSI, 1" FPT, PP & SS	\$2,148.00
01826	MM106 Flowmeter Kit, 5 to 106 GPM, 290 PSI, 1 1/2" FPT, PP & SS	\$2,148.00
02015	MM106FL Flowmeter Kit, 5 to 106 GPM, 290 PSI, M220 flange, PP & SS	\$2,148.00
01827	MM158 Flowmeter Kit, 8 to 158 GPM, 290 PSI, 2" MPT, PP & SS	\$2,148.00
01749	MM238 Flowmeter Kit, 12 to 238 GPM, 290 PSI, 2" MPT, PP & SS	\$1,439.00
02086 A	MM528 Flowmeter Kit, 26.5 to 528 GPM, 145 PSI, 3" MPT, 3-pin MP-150 Connector, PP & SS	\$1,631.00

## FLOW CONTROL OPTIONS

### Liquid Flow Control Valves

19093	Servo Valve, 1" butterfly, Viton® o-rings, 150 PSI	\$429.00
19094	Servo Valve, 1" high pressure butterfly, Viton® o-rings, 300 PSI	\$499.00
19095	Servo Valve, 1" butterfly, aqueous ammonia, EPDM o-rings, 150 PSI	\$429.00
19096	Servo Valve, M200 flanged or 1 1/2" FPT, 1" butterfly, Viton® o-rings, 150 PSI	\$600.00
19097	Servo Valve, M200 flanged or 1 1/2" FPT, 1.5" butterfly, Viton® o-rings, 150 PSI, M200	\$600.00
19098	Servo Valve, M200 flanged or 1 1/2" FPT, 1" butterfly, aqua ammonia, EPDM o-rings, 150 PSI	\$600.00
19099	Servo Valve, M200 flanged or 1 1/2" FPT, 1 1/2" butterfly, aqua ammonia, EPDM o-rings, 150 PSI	\$600.00

\*NCNR

ACCESSORIES

### Hydraulic Flow Control Valves (DrillMaster™ PWM, ProPlant™ STD)

01745	PWM Hydraulic Flow Control Valve w/ Adapter Cable, 8 GPM, SAE 8 ports, 3000 PSI _____	\$769.00
01864	PWM Hydraulic Flow Control Valve w/ Adapter Cable, 15 GPM, SAE 10 ports, 3000 PSI _____	\$1,133.00
02066 A	PWM Hydraulic Flow Control Valve w/ Adapter Cable, 25 GPM, SAE 16 ports, 3000 PSI _____	\$1,714.41
02079 A	PWM Hydraulic Flow Control Valve w/ Adapter Cable, 48 GPM, SAE 20 ports, 3000 PSI _____	\$1,513.00
13859	Servo Type Hydraulic Flow Control Valve, 5 GPM, 3.5 Second, SAE 8 port, 3000 PSI _____	\$1,654.00
14885	Servo Type Hydraulic Flow Control Valve, 10 GPM, 3.5 Second, SAE 8 ports, 3000 PSI _____	\$1,654.00
13857	Servo Type Hydraulic Flow Control Valve, 15 GPM, 3.5 Second, SAE 8 ports, 3000 PSI _____	\$1,654.00
13860	Servo Type Hydraulic Flow Control Valve, 20 GPM, 3.5 Second, SAE 16 ports, 3000 PSI _____	\$2,715.00
13858	Servo Type Hydraulic Flow Control Valve, 35 GPM, 3.5 Second, SAE 16 ports, 3000 PSI _____	\$2,715.00

### EMD - Electric Motor Driver Kits

18008	Electric Motor Driver Kit, STD, 10 Amp _____	\$569.00
01757	Electric Motor Driver Kit, STD, 40 Amp _____	\$851.00
18108	Electric Motor Driver Kit, PWM, 10 Amp _____	\$569.00
01758	Electric Motor Driver Kit, PWM, 40 Amp _____	\$851.00
01904	Electric Motor Driver Kit, PWM, w/ enable, 10 Amp _____	\$569.00
01905	Electric Motor Driver Kit, PWM, w/ enable, 40 Amp _____	\$851.00

### EMD Options

19963	Secondary Pump Enable Cable using Multifunction Output, includes 18928 & 18420 lead _____	\$352.00
18928	Secondary Pump Enable Relay Cable using a Multifunction Output _____	\$277.82
18422	"Y" Cable, 2 Pin MP 480, 1 Shroud & 2 towers, 2', (40 Amp EMD dual motor) _____	\$132.31
18927	Splitter Cable, PWM, runs up to 3 EMD's _____	\$108.41

## RUN/HOLD SENSOR KITS

01535	Run/Hold Sensor Kit, Hall-effect, w/ 2 magnets, 10' extension cable _____	\$211.24
18541	Run/Hold Sensor Kit, whisker switch, w/ magnetic mount, 10' extension cable _____	\$366.57
18529 A	Run/Hold Sensor Kit, whisker switch, (no magnetic mount) _____	\$294.92

## RELAY KITS

19877	Flo-Pro™ Relay Kit, 15 Amp max _____	\$248.00
16087 A	Relay Assembly, 40 Amp, with multifunction enable _____	\$210.78
17200	Relay Kit, Flow-Trak™ II _____	\$187.54

## RPM SENSORS

14471	RPM Sensor Kit, RPM sensor, w/ molded shaft adapter, 6 magnets _____	\$130.64
01539	RPM Sensor Kit, RPM sensor, w/ mounting bracket, 2 magnets _____	\$141.93
01554	RPM Sensor Kit, proximity or gear tooth sensor, w/ 15' extension cable, mounting bracket _____	\$389.00
17922	RPM Sensor Kit, proximity or gear tooth sensor, w/ 6" cable, mounting bracket _____	\$255.19

## PRESSURE SENSORS

18757	Pressure Sensor only, 150 PSI, 4 to 20mA _____	\$278.54
18758	Pressure Sensor only, 300 PSI, 4 to 20mA _____	\$278.54
18754	Pressure Sensor Cable, single, 15' _____	\$100.00
18755	Dual Pressure Sensor Cable, plus console, 15' _____	\$176.97
18764	Pressure Harness Kit, single, w/ 15' sensor cable, 10' extension cable _____	\$149.32
18765	Pressure Harness Kit, dual, w/ 15' sensor cable, 10' extension cable _____	\$278.54

## BIN LEVEL SENSOR

01544	Bin Level Sensor Kit, IR type sensor _____	\$165.00
-------	--	----------

## IBIC BREAKAWAY IMPLEMENT CABLE OPTIONS

18921	IBIC Breakaway Implement Cable, no power connection, 10' _____	\$714.00
19700 C	IBIC Breakaway Implement Cable, w/ power connection, 10' _____	\$833.00
15891 B	IBIC Breakaway Implement Cable, w/ power connection, 30' _____	\$1,246.00

## ISOBUS TAP CABLE OPTIONS

18894	ISOBUS Tap Cable, 6-pin MP 150	\$255.00
18895 A	ISOBUS Tap Cable, 12-pin Ampseal, John Deere®	\$255.00
18896	ISOBUS Tap Cable, 4-pin Delphi MP 630, Great Plains/Dickey JOHN®	\$255.00
18897	ISOBUS Tap Cable, 8-pin GT280, Case IH®	\$255.00
19857	ISOBUS Tap Cable Kit, w/ 6-pin MP150, 18894 and 18955 ECU power adapter cable	\$343.00
18955	Adapter Cable Kit, ECU power	\$160.00
16041 A	ISOBUS Tap Cable, 12-pin Deutsch, Case IH® 2100 Series Planter	\$255.00

## EXTENSION CABLES

### WP (Weather Pack) Extension Cables

11560	Extension Cable, 2-pin WP, 5'	\$58.67
11561	Extension Cable, 2-pin WP, 10'	\$68.15
11671	Extension Cable, 2-pin WP, 15'	\$74.14
11672	Extension Cable, 2-pin WP, 20'	\$75.72
10450	Extension Cable, 3-pin WP, 5'	\$76.53
10449	Extension Cable, 3-pin WP, 10'	\$85.79
10876	Extension Cable, 3-pin WP, 15'	\$97.81
10829	Extension Cable, 3-pin WP, 20'	\$108.24
11462	Extension Cable, 3-pin WP, 25'	\$118.46
11050	Extension Cable, 6-pin WP, 5'	\$138.62
11051	Extension Cable, 6-pin WP, 10'	\$171.86
11052	Extension Cable, 6-pin WP, 20'	\$241.05

### MP (Metri-Pack) 150 Extension Cables

13200	Extension Cable, 2-pin MP 150, 5'	\$74.21
13201	Extension Cable, 2-pin MP 150, 10'	\$80.11
13202	Extension Cable, 2-pin MP 150, 15'	\$86.60
13203	Extension Cable, 2-pin MP 150, 20'	\$90.39
13204	Extension Cable, 2-pin MP 150, 25'	\$97.80
13205	Extension Cable, 3-pin MP 150, 5'	\$82.01
13206	Extension Cable, 3-pin MP 150, 10'	\$87.55
13207	Extension Cable, 3-pin MP 150, 15'	\$98.43
13208	Extension Cable, 3-pin MP 150, 20'	\$104.69
13209	Extension Cable, 3-pin MP 150, 25'	\$111.73
13419	Extension Cable, 3-pin MP 150, 50'	\$158.70
14482	Extension Cable, 5-pin MP 150, 5'	\$93.27
14483	Extension Cable, 5-pin MP 150, 10'	\$112.63
14484	Extension Cable, 5-pin MP 150, 15'	\$137.43
14485	Extension Cable, 5-pin MP 150, 20'	\$161.21
14486	Extension Cable, 5-pin MP 150, 25'	\$185.55
18823	Extension Cable, 6-pin MP 150, 5'	\$67.99
18756	Extension Cable, 6-pin MP 150, 10'	\$107.35
18824	Extension Cable, 6-pin MP 150, 15'	\$127.05
18825	Extension Cable, 6-pin MP 150, 20'	\$178.89
18826	Extension Cable, 6-pin MP 150, 25'	\$186.98
19774	ISOBUS Extension Cable, 6-pin MP 150, 5'	\$212.15
19775	ISOBUS Extension Cable, 6-pin MP 150, 10'	\$232.68
19776	ISOBUS Extension Cable, 6-pin MP 150, 20'	\$273.63
19777	ISOBUS Extension Cable, 6-pin MP 150, 30'	\$314.71
19778	ISOBUS Extension Cable, 6-pin MP 150, 40'	\$355.79
13220	Extension Cable, 10-pin MP 150, 5'	\$142.53
13221	Extension Cable, 10-pin MP 150, 10'	\$170.20
13222	Extension Cable, 10-pin MP 150, 15'	\$194.62
13223	Extension Cable, 10-pin MP150, 20'	\$233.12
13224	Extension Cable, 10-pin MP 150, 25'	\$274.69
17095	Extension Cable, 10-pin MP 150, 30'	\$324.70
17096	Extension Cable, 10-pin MP 150, 40'	\$390.09
17269	Extension Cable, 10-pin MP 150, 45'	\$428.53
14142	Extension Cable, 10-pin MP 150, 50'	\$506.84

14363	Extension Cable, 10-pin MP 150, 5-16 & 5-20 gauge, 5'	\$150.84
14316	Extension Cable, 10-pin MP 150, 5-16 & 5-20 gauge, 10'	\$223.65
14317	Extension Cable, 10-pin MP 150, 5-16 & 5-20 gauge, 15'	\$268.87
14364	Extension Cable, 10-pin MP 150, 5-16 & 5-20 gauge, 20'	\$330.30
14365	Extension Cable, 10-pin MP 150, 5-16 & 5-20 gauge, 25'	\$388.39
14419	Extension Cable, 10-pin MP 150, 5-16 & 5-20 gauge, 50'	\$666.77

### MP (Metri-Pack) 150/480 Extension Cables

14146	Extension Cable, 7-pin MP 150/480, 2-10 & 5 -18 gauge, 5'	\$194.70
14147	Extension Cable, 7-pin MP 150/480, 2-10 & 5 -18 gauge, 10'	\$281.69
14103	Extension Cable, 7-pin MP 150/480, 2-10 & 5 -18 gauge, 15'	\$364.32
14236	Extension Cable, 7-pin MP 150/480, 2-10 & 5 -18 gauge, 20'	\$442.77
14237	Extension Cable, 7-pin MP 150/480, 2-10 & 5 -18 gauge, 25'	\$516.51
17415	Extension Cable, 7-pin MP 150/480, 2-10 & 5 -18 gauge, 50'	\$913.42
18830	Extension Cable, 7-Pin MP 150/480, 2-12 & 5 -20 gauge, 5'	\$159.41
18831	Extension Cable, 7-Pin MP 150/480, 2-12 & 5 -20 gauge, 10'	\$206.00
18832	Extension Cable, 7-Pin MP 150/480, 2-12 & 5 -20 gauge, 15'	\$243.19
18833	Extension Cable, 7-Pin MP 150/480, 2-12 & 5 -20 gauge, 20'	\$285.27
18834	Extension Cable, 7-Pin MP 150/480, 2-12 & 5 -20 gauge, 25'	\$327.11
18835	Extension Cable, 7-Pin MP 150/480, 2-12 & 5 -20 gauge, 50'	\$536.64

### MP (Metri-Pack) 280 Extension Cables

17445	Extension Cable, 2-pin MP 280, 10'	\$123.05
17446	Extension Cable, 2-pin MP 280, 20'	\$193.32
18288	Extension Cable, 2-pin MP 280, 5'	\$87.82
18289	Extension Cable, 2-pin MP 280, 15'	\$158.25
18290	Extension Cable, 2-pin MP 280, 25'	\$228.54

### MP (Metri-Pack) 480 Extension Cables

18827	Extension Cable, 2-Pin MP 480, 5'	\$140.91
18828	Extension Cable, 2-Pin MP 480, 10'	\$160.96
18436 A	Extension Cable, 2-pin MP 480, 15'	\$175.87
18421 A	Extension Cable, 2-pin MP 480, 20'	\$215.00
18829	Extension Cable, 2-Pin MP 480, 25'	\$217.65
19745	Extension Cable, 2-pin MP 480, 30'	\$237.25
19347	Extension Cable, 2-pin MP 480, 40'	\$356.72
19348	Extension Cable, 2-pin MP 480, 50'	\$383.57

### GT Series Extension Cables

19313 A	Extension Cable, 16-pin GT, 5'	\$192.77
19314 A	Extension Cable, 16-pin GT, 10'	\$292.45
19315 A	Extension Cable, 16-pin GT, 15'	\$392.41
19316 A	Extension Cable, 16-pin GT, 20'	\$496.33
19317 A	Extension Cable, 16-pin GT, 30'	\$695.98
19318 A	Extension Cable, 16-pin GT, 40'	\$895.51
19319 A	Extension Cable, 16-pin GT, 50'	\$1,095.16

### Amphenol Extension Cables for SafeGuard™ Sensors

19694 B	Extension Cable, 6-pin Amphenol twisted pair, 2.5'	\$75.06
19616 B	Extension Cable, 6-pin Amphenol twisted pair, 5'	\$92.73
19617 B	Extension Cable, 6-pin Amphenol twisted pair, 10'	\$126.58
19618 B	Extension Cable, 6-pin Amphenol twisted pair, 15'	\$161.15
19619 B	Extension Cable, 6-pin Amphenol twisted pair, 20'	\$195.73
19620 B	Extension Cable, 6-pin Amphenol twisted pair, 25'	\$230.32
19621 B	Extension Cable, 6-pin Amphenol twisted pair, 30'	\$264.91

### JWPF Extension Cables for SafeGuard™ Sensors (pre-2017)

18525	Extension Cable, 6-pin MP150, w/ twisted pair, 15'	\$145.69
-------	--	----------

### Connector Replacement Kits

10262	Round Connector Replacement Kit, 2-pin, w/ both halves and pins _____	\$25.17
11829	Connector Replacement Kit, 2-pin WP, w/ both halves, pins and seals _____	\$32.62
10523	Connector Replacement Kit, 3-pin WP, w/ both halves, pins and seals _____	\$37.72
11154	Connector Replacement Kit, 6-pin WP, w/ both halves, pins and seals _____	\$67.00
13231	Connector Replacement Kit, 2-pin MP, w/ both halves, pins and seals _____	\$41.62
18654	Connector Replacement Kit, 2-Pin MP 480, w/ both halves, pins and seals _____	\$46.83
18722	Connector Replacement Kit, 2-Pin MP 280, w/ both halves, pins and seals _____	\$28.63
13232	Connector Replacement Kit, 3-pin MP 150, w/ both halves, pins and seals _____	\$46.79
13759	Connector Replacement Kit, 3-pin MP 630, w/ both halves, pins and seals _____	\$57.23
13233	Connector Replacement Kit, 4-pin MP, w/ both halves, pins and seals _____	\$50.55
14808	Connector Replacement Kit, 5-pin MP, w/ both halves, pins and seals _____	\$35.36
13234	Connector Replacement Kit, 6-pin MP, w/ both halves, pins, seals _____	\$47.60
14684	Connector Replacement Kit, 7-pin MP, w/ both halves, pins and seals _____	\$52.14
13235	Connector Replacement Kit, 10-pin MP, w/ both halves, pins and seals _____	\$75.68
19693 A	Connector Replacement Kit, 6-pin Amphenol, w/ SafeGuard™ Sensor _____	\$53.61
13369	Connector Replacement Kit, 15-pin, MT-3000, (harness half ONLY, pins and strain relief) _____	\$47.67

### Dust Covers

11400	Tower Dust Cover, 2-pin WP, male _____	\$13.41
11401	Shroud Dust Cover, 2-pin WP, female _____	\$13.41
18111	Shroud, w/ jumper wire, 2-Pin WP, female _____	\$15.22
10445	Shroud Dust Cover, 3-pin WP, female _____	\$16.29
10447	Tower Dust Cover, 3-pin WP, male _____	\$16.29
10451	Shroud Dust Cover, w/ jumper wire, 3-pin WP, female _____	\$18.04
11034	Tower Dust Cover, 6-pin WP, male _____	\$22.00
11035	Shroud Dust Cover, 6-pin WP, female _____	\$22.22
13104	Tower Dust Cover, 2-pin MP, male _____	\$11.00
13105	Shroud Dust Cover, 2-pin MP, female _____	\$11.00
13100	Shroud Dust Cover, w/ jumper wire, 3-pin MP, female _____	\$16.45
13106	Tower Dust Cover, 3-pin MP, male _____	\$16.45
13107	Shroud Dust Cover, 3-pin MP, female _____	\$16.45
13110	Tower Dust Cover, 6-pin MP, male _____	\$24.42
13111	Shroud Dust Cover, 6-pin MP, female _____	\$24.42
14108	Tower Dust Cover, 7-pin MP, male _____	\$34.10
14109	Shroud Dust Cover, 7-pin MP, female _____	\$34.10
13112	Tower Dust Cover, 10-pin MP, male _____	\$25.25
13113	Shroud Dust Cover, 10-pin MP, female _____	\$25.25
19824	Shroud Dust Cover, 2-pin MP 480, female _____	\$25.92
19825	Tower Dust Cover, 2-pin MP 480, male _____	\$22.06
19823	Tower Dust Cover, 16-pin GT, male _____	\$35.03
19703	Shroud Dust Cover, 16-pin GT, female _____	\$21.59
19688	Tower Dust Cover, 6-pin Amphenol, male _____	\$17.89
19689	Shroud Dust Cover, 6-pin Amphenol, female _____	\$12.14



# REPLACEMENT PARTS

## CALC-AN-ACRE™ MODELS LR & II

13090	Power Harness, speed, run/hold (C-97-LR)	\$185.66
14553	Extra Main Harness Kit, (C-97-LR), (includes 13181, 13090 and 01530)	\$446.69
17176	Harness, power, speed, RPM, run/hold, Calc-An-Acre™ II	\$207.14

## FLOW TRAK™ MODELS LR & II

01536	*Relay Kit, Flow-Trak™ 97 LR	\$125.75
13097	Power Harness, flow, speed, run/hold, Flow-Trak™ 97 LR	\$250.14
17194	Power Harness, flow, speed, run/hold, Flow-Trak™ II	\$255.15

## FLOWMATE™

18155 B	Power Cable, 2-pin WP, 10'	\$46.94
18157	Fuse & Terminal Kit, 1 Amp	\$16.08
11837	Dual Lock Fastener Kit, (4 sets of 1" X 1")	\$22.62 NET

## SHAFT-TRAK™

14536	Molded Shaft Adapter Kit, w/ 10 magnets	\$78.00
14473 C	Branch Harness, Shaft-Trak™, 6 sensor	\$406.25

## SODPRO™ II

17077	Power Harness, speed, run/hold	\$186.29
-------	--------------------------------	----------

## MANUAL CONTROLLERS

17985 A	Power Cable, 2-pin molex, 10 Amp fuse, 10'	\$71.30
17986	Motor Cable, MC-10, 2-pin molex to WP, 20'	\$65.07
14728	Pressure Gauge Bracket, MC-10, narrow console, (gauge not included)	\$50.00
17444	Power Cable, 2-pin MP280, 25 Amp fuse, 10'	\$147.10
17871	Power Cable, 2-pin MP280, 40 Amp fuse, 20'	\$255.00
17447	Motor Cable, 2-pin MP280, 15'	\$134.35
17448	Motor Cable, 2-pin MP280, 20'	\$169.55
17449	Motor Cable, 2-pin MP280, 25'	\$204.78
17450	Motor Cable, 2-pin MP280, 30'	\$239.98
14799	Pressure Gauge Bracket for MC-25, (gauge not included)	\$38.00
18982	Power Cable, w/ 5A fuse kit, 10'	\$54.70
18985	Pressure Gauge Bracket, MC-10, (Deep Back, No Gauge)	\$69.07

## FLO-PRO™

19834	Branch Harness, 10'	\$332.84
19835	Power Cable, 10'	\$79.63
19444	Power Cable, 15'	\$99.73
19876	Relay Module	\$113.45
18941	Motor Lead, 2-pin WP, 4'	\$38.19

## SAFEGUARD™ BLOCKAGE MONITOR

### Miscellaneous Sensor Parts

18510 C	U-clip, SS	\$2.34
18521	O-ring, FKM (Viton® type)	\$8.00
18963	O-ring, orifice plate	\$1.82
18514	Cartridge Retainer Clip	\$4.02
18653	SafeGuard™ Sensor Mounting Spacer	\$4.34
18721	SafeGuard™ Sensor Bracket	\$12.43
21993	Cartridge Range Extender	\$18.63
02011	Magnet Bar Mount, ISOmod™	\$46.84

### Console to Hitch Cable Options

19624 B	Adapter, 6-pin, M/P150 to Amphenol twisted pair, 15'	\$145.68
19676 A	Adapter, 6-pin, M/P150 to Amphenol twisted pair, 25'	\$212.25

### Terminators

19681 A	Terminator, 6-pin, Amphenol tower _____	\$31.30
19682 A	Terminator, 6-pin, Amphenol shroud _____	\$22.15

### Pre-2017 Sensor Adapter Cables

19837 A	Adapter Cable, pre-2017 sensors, JWPF Tower to Amphenol Shroud _____	\$17.00 NET
19838 A	Adapter Cable, pre-2017 sensors, JWPF Shroud to Amphenol Tower _____	\$17.00 NET

### Pre-2017 SafeGuard™ Parts

18667	Dust Cover, 6-pin RCPTCL _____	\$12.14
-------	--------------------------------	---------

## MT-2405 F™ II SERIES

13757	Branch Harness, speed, run/hold, MT-2405 F™ II and FTW II, 10' _____	\$231.96
13758	Branch Harness, boom, power, servo, MT-2405 F™ II and FTW II, 10' _____	\$199.11

## MT-NH3™

13620	Power Cable, 2-pin MP, MT-NH3™, 10' _____	\$54.37
13348	Pin, Quick Release Switchbox, SS _____	\$36.66
17858	Suction Cup Mounting Kit for Console _____	\$178.00
18767	Adapter Cable, power/master switch, MT-NH3™ _____	\$80.55
21963	Switch Assembly, run/hold, SprayMate™ II, MT-NH3™ II, GSC-1000™ _____	\$116.29
21779	Power Switch Assembly for consoles _____	\$116.29

## SPRAYMATE™ II

14311	Main Harness, NH3, SprayMate™ & SprayMate™ II, 10' _____	\$202.02
14313 F	Harness, flow, control, boom, WPT-PGS, SprayMate™ II _____	\$308.91
14314	Ignition Cable, 72" _____	\$42.97
14315 C	Power (battery) Cable, 2-pin WP, 10 Amp fuse, 15' _____	\$146.20
14469	Solenoid Adapter Cable, 3-Pin WPS to 1/4" QD _____	\$34.89
17158	Ball Valve Adapter Cable, 3-boom 2-wire, RoadMaster™ & SprayMate II™ _____	\$574.45
17782	Auto Section Cable, SprayMate II™ _____	\$383.00
17786	Multi Section Adapter Cable, SprayMate II™, NH3, 10' _____	\$228.63
17844	Multi-Section Branch Harness, NH3 _____	\$262.79
18034	Multi-Section EMD Adapter Cable, SprayMate™ II _____	\$114.85
18267	Relay, 50A 12v SPST, SprayMate™ II fertilizer kit _____	\$74.66
18777	Harness Adapter Cable, SprayMate™ Plus Console to SprayMate™ II _____	\$100.25
19749	Section Relay Module Enable _____	\$89.83
21778	Run/Hold Switch Assembly, SprayMate™ Plus, RoadMaster™, DrillMaster™ _____	\$116.30
21779	Power Switch Assembly for consoles _____	\$116.29
21963	Run/Hold Switch Assembly, SprayMate™ II, MT-NH3™ II, GSC-1000™ _____	\$116.29

## SPRAYMATE™ PLUS

14315 C	Power (battery) Cable, 2-pin WP, 10 Amp fuse, 15' _____	\$146.20
14469	Solenoid Adapter Cable, 3-pin WPS to 1/4" QD _____	\$34.89
18280	Harness, flow, control, boom, WPS-PGS, SprayMate™ Plus _____	\$324.03
18532 A	Harness, flow, control, boom, WPT-PGS, SprayMate™ Plus _____	\$324.03
18777	Harness Adapter Cable, SprayMate™ Plus Console to SprayMate™ II _____	\$100.25
19507	Pressure Sensor Extension Cable, 50' _____	\$214.55
19508	Pressure Sensor Extension Cable, 25' _____	\$124.00
21778	Run/Hold Switch Assembly, SprayMate™ Plus, RoadMaster™, DrillMaster™ _____	\$116.30
21779	Power Switch Assembly for consoles _____	\$116.29
21963	Run/Hold Switch Assembly, SprayMate™ II, MT-NH3™ II, GSC-1000™ _____	\$116.29
16008 A	Adapter Cable, SprayMate™ Plus to Raven CR7 _____	\$252.31
19922 A	Adapter Cable, CPC female connector, SprayMate™ Plus to Raven 440, 10' _____	\$263.25
15861 A	Adapter Cable, CPC male (old style) connector, SprayMate™ Plus to Raven 440, 10' _____	\$258.09

## RATEKING™ PLUS & RATEKING™ DUAL PLUS

18802	Power Cable, 15 Amp fuse, 15'	\$344.92
18872	Section Branch Harness, 3 section, WPT-PGS, 10'	\$249.16
18819	Section Branch Harness, 5 section, WPT-PGS, 10'	\$285.39
18820	Section Branch Harness, 7 section, WPT-PGS, 10'	\$326.74
18675 B	Control Branch Harness, RateKing™, 10'	\$377.10
18676 B	Control Branch Harness, RateKing™ Dual Plus Channel 2, 10' Dual Plus Channel 2 Harness	\$279.00
18757	Pressure Sensor only, 150 PSI, 4 to 20mA	\$278.54
18758	Pressure Sensor only, 300 PSI, 4 to 20mA	\$278.54
18754	Single Pressure Sensor Cable, Plus Series	\$100.00
18755	Dual Pressure Sensor Cable, Plus console	\$176.97
19507	Pressure Sensor Extension Cable, 50'	\$214.55
19508	Pressure Sensor Extension Cable, 25'	\$124.00
19978 A	Cable, RateKing™ Plus to Raven Console	\$718.47
19979 A	Cable, RateKing™ Dual Plus to Raven Console	\$913.69

## DUAL ISOMOD™ RATE CONTROLLER

02011	Magnet Bar Mount, ISOmod™	\$46.84
19170	Fuse Holder Kit	\$72.13
19295	Power Cable, 2-pin MP 480, 30'	\$231.94
19604 A	Bulkhead Harness, Dual ISOmod™, 2'	\$701.25
19605 A	Branch Harness, Dual ISOmod™, Channel 1, 10'	\$328.80
19606 A	Branch Harness, Dual ISOmod™, Channel 2, 10'	\$329.00
19669	Branch Harness, Dual ISOmod™, 6 section, 10'	\$331.00
19670	Branch Harness, Dual ISOmod™, 12 section WPT-PGS, 10'	\$600.00

## ISOBUS TAP CABLE PARTS

18896	ISOBUS Tap Cable, 4-pin Delphi MP 630, Great Plains/Dickey JOHN®	\$255.00
18944	Tap Cable (in-cab) Kit, w/ power cable, Deutsch DTM	\$255.00
18945	Tap Cable (in-cab) Kit, w/ power cable, Deutsch DT	\$343.00
18950	Tap Cable (in-cab) Kit, w/ power adapter, Deutsch DT	\$343.00
18967	Terminator Cable, w/TBC Plug, Deutsch DT	\$201.04
18968	Terminator Cable, w/TBC Plug, Deutsch DTM	\$223.00

## RATEKING™ XRS - ORCHARD/VINEYARD RATE CONTROLLER

19883	Tractor Harness, RateKing™ XRS, 5'	\$412.99
19882	Trailer Branch Harness, RateKing™ XRS, 15'	\$837.36
14315 C	Power (battery) Cable, 2-pin WP, 10 Amp fuse, 15'	\$146.20

## SPRAYMATE™ XRS - ORCHARD/VINEYARD RATE CONTROLLER

19958 A	Control Branch Harness, SprayMate™ XRS, 15'	\$551.93
14315 C	Power (battery) Cable, 2-pin WP, 10 Amp fuse, 15'	\$146.20

## GSC-1000™

14983	Harness Branch, servo, flow, RPM	\$279.83
14315 C	Power (battery) Cable, 2-pin WP, 10 Amp fuse, 15'	\$146.20
14536	Molded Shaft Adapter Kit, w/ 10 magnets	\$78.00
14471	RPM Sensor Kit, RPM sensor, w/ molded shaft adapter, 6 magnets	\$130.64
21779	Power Switch Assembly for consoles	\$116.29
21963	Run/Hold Switch Assembly, SprayMate™ II, MT-NH3™ II, GSC-1000™	\$116.29



## ROADMASTER™ & MT-400™ SERIES

17158	Ball Valve Adapter Cable, 3-boom 2-wire, RoadMaster™ & SprayMate II™	\$574.45
14469	Solenoid Adapter Cable, 3-Pin WPS to 1/4" QD	\$34.89
18098	Calibration Lockout Key, set of two, RoadMaster™, SprayMate™ Plus	\$4.68
14313 F	Harness, flow, control, boom, WPT-PGS, SprayMate™ II	\$308.91
14314	Ignition Cable, 72"	\$42.97
14463	*In-Line Servo Valve Adapter Cable, (MT-400™ with S)	\$40.54
14315 C	Power (battery) Cable, 2-pin WP, 10 Amp fuse, 15'	\$146.20
21778	Run/Hold Switch Assembly, SprayMate™ Plus, RoadMaster™, DrillMaster™	\$116.30
21779	Power Switch Assembly for consoles	\$116.29
17523	Remote RoadMaster™ Blast, Run/Hold Cable, w/ mini-din connector	\$73.03
01744	RoadMaster™ Blast/Run/Hold Remote Switch Box, w/ 3-pin MP connector (current)	\$246.00
17560	RoadMaster™ Blast/Run/Hold Remote Switch Box, w/ circular connector (old style)	\$246.00

## PROPLANT™

### Console

17339	Section Harness, power, 15'	\$323.76
17360	Harness, flow, servo, run/hold, 15'	\$241.61

### Harness Kit Parts - Single Drive MOUNTED

17358	Section Harness, 1 section, 20'	\$76.15
17359	Harness, flow, servo, run/hold, 1 section, 20'	\$224.53

### Harness Kit Parts - Single Drive DRAWN

17358	Section Harness, 1 section, 20'	\$76.15
17359	Harness, flow, servo, run/hold, 1 section, 20'	\$224.53

### Harness Kit Parts - Multiple Drive MOUNTED

17307	Section Branch Harness, 1-3 sections, 20'	\$198.31
17308	Section Branch Harness, flow with servo/RH, 1-3 sections	\$331.35

### Harness Kit Parts - Multiple Drive DRAWN

17307	Section Branch Harness, 1-3 sections, 20'	\$198.31
17308	Section Branch Harness, flow with servo/RH, 1-3 sections	\$331.35

## HYDRAULIC DRIVE PARTS

17320 A	Toolbar Bracket	\$331.95
17321 C	Motor Bracket	\$277.77
17351	Toolbar U-Bolt, 7"	\$24.87
17395	Bolt/Fastener Kit, hydraulic drive assembly	\$32.51
17396	Drive Chain Kit, #40, 10'	\$83.77
17554	Drive Chain Kit, #50, 10'	\$143.19
17398	Secondary Drive Fittings Kit	\$67.09
17399	Primary Drive Fittings Kit	\$377.83
17922	RPM Sensor Kit, proximity or gear tooth sensor, w/ 6" cable, mounting bracket	\$255.19
17917	Proximity Sensor, w/ 6" lead	\$175.00
17556	Sprocket, 50-16 x 40-16 drive	\$135.07
17322	Sprocket, Idler #40, 32 x 16	\$395.12
17323	Sprocket, Idler #40, 16 x 16	\$148.30
17555	Sprocket, Idler #50, 32 x 16	\$476.31
17576	Hydraulic Motor/Shutoff Valve Assembly, 4.9 CID, (no sprockets)	\$2,318.00
17394	Sprocket, #40, 32 Tooth, 3/4" Split	\$240.60
17388	Sprocket, #40, 32 Tooth, 7/8" Split	\$240.60
17558	Sprocket, #50, 28 Tooth, 3/4" Hex Split	\$324.22
17557	Sprocket, #50, 28 Tooth, 7/8" Hex Split	\$324.22
18031	Hydraulic Motor Cross Port Plug (replaces shutoff valve on motor for PWM control)	\$96.17
18348	Poppet Valve Assembly	\$197.61
15909 A	Hydraulic Motor Seal Kit	\$225.05
17370	ProPlant™ Variable Rate Token, green	\$240.60

# DRILLMASTER™

## Console

14315 C	Power (battery) Cable, 2-pin WP, 10 Amp fuse, 15'	\$146.20
21778	Run/Hold Switch Assembly, SprayMate™ Plus, RoadMaster™, DrillMaster™	\$116.30
21779	Power Switch Assembly for consoles	\$116.29

## Harness Kit for MOUNTED Single-Drive parts list

17894	Mounted Branch Harness, DrillMaster™	\$270.31
-------	--------------------------------------	----------

## Harness Kit for DRAWN Two-Drive parts list

13112	Tower Dust Cover, 10-pin MP, male	\$25.25
17096	Extension Cable, 10-pin 40' MP	\$390.09
17883	PWM Run/Hold Cable, DrillMaster™	\$120.45
18026	Drawn Left/Right Branch Harness, 2-Section, DrillMaster™	\$175.27
21612 B	Multi Section Module, DrillMaster™	\$590.62

## Harness Kit for DRAWN Three-Drive parts list

17096	Extension Cable, 10-pin 40' MP	\$390.09
17881	Right or Left Section Branch Harness, DrillMaster™	\$256.16
17882	Center Section Branch Harness, DrillMaster™	\$167.58
17883	PWM Run/Hold Cable, DrillMaster™	\$120.45
21612 B	Multi Section Module, DrillMaster™	\$590.62

## Planter Drive Kit Parts List

17321 C	Motor Bracket	\$277.77
17351	Toolbar U-Bolt, 7"	\$24.87
17394	Sprocket, #40, 32 Tooth, 3/4" Split	\$240.60
17388	Sprocket, #40, 32 Tooth, 7/8" Split	\$240.60
17558	Sprocket, #50, 28 Tooth, 3/4" Hex Split	\$324.22
17557	Sprocket, #50, 28 Tooth, 7/8" Hex Split	\$324.22
17556	Sprocket, 50-16 x 40-16 drive	\$135.07
17395	Bolt/Fastener Kit, hydraulic drive assembly	\$32.51
17396	Drive Chain Kit, #40, 10'	\$83.77
17554	Drive Chain Kit, #50, 10'	\$143.19
17576	Hydraulic Motor/Shutoff Valve Assembly, 4.9 CID, (no sprockets)	\$2,318.00
17922	RPM Sensor Kit, proximity or gear tooth sensor, w/ 6" cable, mounting bracket	\$255.19
18005	Primary Drive Fittings Kit	\$327.26
17398	Secondary Drive Fittings Kit	\$67.09
18006	Hydraulic Control Valve Remote Mount Bracket	\$64.47
18348	Poppet Valve Assembly	\$197.61

# NH3 APPLICATION REPLACEMENT PARTS

11191	Strainer Screen, NH3, #20, SS	\$53.43
11192	Strainer Gasket, NH3, Teflon	\$10.96
14851	Strainer Plug, w/ Alnico magnet, NH3	\$103.97
17696	Seal Kit for SAFi NH3 Valve, (Velan)	\$438.64
17741	SAFi Cover O-ring, (New Style)	\$7.93
17913	Strainer Gasket, NH3500, NH3, 1", teflon	\$71.61
17914	Strainer Screen, Liquifier NH3, 1.25", #20, SS	\$71.61
17915	Strainer Gasket, Liquifier NH3, 1.25", teflon	\$93.14
17972 A	KZValve® NH3 Shutoff Valve, 1"	\$1,428.59
17973 A	Seal Kit for KZ Valve, NH3, 1"	\$93.77
18183	Heat Exchanger, Liquifier, Liquifier Max, 1 1/2" MPT	\$2,642.64
18186	Shutoff Valve, Liquifier Max, NH3, 1 1/2"	\$1,699.17
18302	Strainer, w/ magnet assembly, NH3, 1 1/2"	\$407.19
18459	KZ Shutoff Valve Actuator, NH3, 1", 1 1/2"	\$819.36
18775	KZ Servo Valve Actuator, NH3, 1", 1 1/2"	\$893.17
20365	Strainer Assembly, NH3500	\$349.23
18287	Cable, 3-pin WPS to WPS adapter, (converts a WP output from a tower to a shroud)	\$48.12
10899	FM750 SS for NH3 Flowmeter, 2-40 GPM, 500 PSI, 3/4" FPT, SS & nylon Hastelloy	\$1,108.95
19101 B	Servo Valve, NH3, Liquifier Junior, ultra low rate, 3/4" x 1"	\$1,534.00
19102 B	Servo Valve, NH3, NH3500, 3/4" x 1"	\$1,516.00
19103 B	Servo Valve, NH3, Liquifier Junior, 1" x 1"	\$1,484.00

### NH3 Application Replacement Parts, cont.

18185	Servo Valve, NH3, Liquifier Max, 1 1/2" _____	\$1,699.17
18187 A	Servo Valve, NH3, Liquifier, 1" _____	\$1,433.38
18465	Heat Exchanger, Liquifier Junior, ultra low rate _____	\$2,642.62
18555	Heat Exchanger, Liquifier Junior _____	\$2,642.62
18307	Strainer, Liquifier Junior, Liquifier Junior, ultra low rate _____	\$285.21
21691 A	KZ Valve®, 1", body only _____	\$599.65
13273	Plumbing Panel Harness, NH3, (current controllers), 7' _____	\$504.23
10233	Steel Vapor Tube, 1/2" x 1' _____	\$64.75
11008	Vapor Tubing Elbow, 3/8" FPT x 3/8" _____	\$29.75
11009	Vapor Tubing Elbow, 3/4" MPT x 3/8" _____	\$30.67
11022	Nipple, 1/8" x 1 1/2", SS _____	\$25.78
11023	Bushing, 1/4" x 1/8", SS _____	\$20.05
11024	Vapor Tubing, 3/4" EVA, 25' _____	\$305.19
11025	Vapor Tubing, 1/2" EVA, 25' _____	\$222.22
11040	Accessory Kit, NH3500 _____	\$188.87
11305	Hold/Cutout Module, MT-3000™, MT-5000™ _____	\$208.48
12828	Plug, 1/8", (Low Rate Kit) _____	\$27.00
13348	Pin, Quick Release Switchbox, SS _____	\$36.66
13504	Adapter Cable, in-line M-T servo valve, 1' _____	\$101.72
13620	Power Cable, 2-pin MP, MT-NH3™, 10' _____	\$54.37
14232	Hose Barb, 1/4" x 3/8" orifice, (3/32) _____	\$15.36
17892	Low Rate Conversion Kit, NH3500 _____	\$435.44
17995	Bracket, NH3500, Low Rate Support _____	\$66.58
18000	Nipple, 3/4" X Close blk schedule 40 _____	\$7.74
18001	Nipple, 3/4" X 12" blk schedule 40 _____	\$38.53
18003	Coupling 1" x 3/4", (Low Rate Kit) _____	\$21.10
18004	Hose, NH3, 1" x 3', (Low Rate Kit) _____	\$507.89
18014	Nipple, 3/4" X 2" blk schedule 40 _____	\$8.21
18188	Hose Barb, 1/4" x 3/8" orifice, (3/64) _____	\$15.36
18221	Elbow, 3/4" MPT x 3/8", nylon _____	\$10.58
18222	Elbow, 1/4" x 1/4", nylon _____	\$10.58
19609	Liquifier Junior Upgrade Kit _____	\$73.05
20486	Tubing, NH3500, 3/8" EVA _____	\$3.60

## DIRECTCONNECT™ PARTS

### Topcon X20, X15, X10 w/30S ECU Parts

17529	Multi Section Branch Harness, NH3, 1-5 sections, 2' _____	\$251.86
17584	Adapter Cable, NH3, 1 section, 1' _____	\$195.70
17739	Multi Section Boom Master Module, 1-5 sections _____	\$342.06
17608	Adapter Cable, w/o power, Topcon 30S ECU to MT Liquid/NH3, 10' _____	\$558.94

### Topcon ASC-10 ECU Parts

18324	Main Branch Harness for Topcon _____	\$677.82
18325	Harness, speed/flow with servo/pressure, Topcon _____	\$351.91
18326	DirectConnect™ Harness, 1-6 sections _____	\$358.13
18327	DirectConnect™ Harness, 7-10 sections _____	\$315.89

### John Deere® GS2 Parts

17962	Control Harness, Liquid/NH3, 7 section, GS2,3 10' _____	\$954.00
18456	DirectConnect™ Main Harness for GreenStar™ Rate Controller _____	\$483.00
18458	DirectConnect™ Master/Relief/Agitation Cable for GreenStar™ Rate Controller _____	\$258.00
18457 A	DirectConnect™ Control/Flow for GreenStar™ Rate Controller, 1 section _____	\$322.00
18326	DirectConnect™ Harness, 1-6 sections _____	\$358.13
18327	DirectConnect™ Harness, 7-10 sections _____	\$315.89
01592	Servo Valve Signal Chopper, (REQUIRED with Micro-Trak servo valve) _____	\$259.00
17529	Multi Section Branch Harness, NH3, 1-5 sections, 2' _____	\$251.86
17584	Adapter Cable, NH3, 1 section, 1' _____	\$195.70
17739	Multi Section Boom Master Module, 1-5 sections _____	\$342.06
17643	Adapter Cable, w/o power, Greenstar™ to MT Liquid/NH3, 10' _____	\$523.00
17924	Adapter Cable, GS2, 16-pin to 37-pin CPC _____	\$355.64

**Trimble® EZ Boom® 2010 Parts**

17582	Adapter Cable, w/ power, Raven / Trimble® EZ Boom® 2010 to MT, 10'	\$608.66
17529	Multi Section Branch Harness, NH3, 1-5 sections, 2'	\$251.86
17584	Adapter Cable, NH3, 1 section, 1'	\$195.70
17739	Multi Section Boom Master Module, 1-5 sections	\$342.06
17627	DirectConnect™ Harness Kit for Trimble® EZ Boom™ 2010, liquid, 1-7 section	\$1,081.00
18330	Branch Cable, Trimble®	\$340.54

**Trimble® Field IQ™ Parts**

18328	DirectConnect™ Harness Kit for Trimble® Field IQ™, 1 section, liquid/NH3, 7'	\$427.00
18349	DirectConnect™ Trimble® Field IQ™ Harness Kit, liquid, 1-6 sections, 7'	\$726.00
18350	*DirectConnect™ Trimble® Field IQ™, Harness Kit, liquid, 1-12 sections, 7'	\$932.00
19713	Master Valve Cable, Trimble® Field IQ™, 7'	\$147.50
19721	DirectConnect™ Harness Kit for Trimble® Field IQ™, 1-6 sections, NH3, 7'	\$861.00
19722	*DirectConnect™ Harness Kit for Trimble® Field IQ™, 1-12 section, NH3, 7'	\$1,062.00
18329	Main Branch Harness, Trimble®, 1 section	\$594.24

**Raven 440/450 Parts**

17529	Multi Section Branch Harness, NH3, 1-5 sections, 2'	\$251.86
17582	Adapter Cable, w/ power, Raven / Trimble® EZ Boom® 2010 to MT, 10'	\$608.66
17584	Adapter Cable, NH3, 1 section, 1'	\$195.70
17739	Multi Section Boom Master Module, 1-5 Sections	\$342.06

**DIRECTCONNECT™ PARTS****Ag Leader® INSIGHT DirectCommand™ Parts**

17599	Multi Section Boom Master Module, Deutsch connectors, 1-10 sections	\$518.52
17941	Branch Cable, AgLeader® DirectCommand™ to NH3	\$697.57
17942	Adapter Cable, AgLeader® DirectCommand™ to Single Section	\$42.11
17943	Multi-Section Boom Master Module, AgLeader® DirectCommand™	\$355.03
17529	Multi Section Branch Harness, NH3, 1-5 Sections, 2'	\$251.86
17857	Adapter Cable, w/o power, AgLeader® DirectCommand™ to MT Liquid, 10'	\$647.33
18264	Servo Branch Harness, AgLeader® Direct Command™ Flow	\$233.32
18265	7-Boom Branch Harness, AgLeader® Direct Command™ Flow	\$290.73

**SPEED AND RUN/HOLD PARTS****Current (LR, II & Plus models)**

14324	Adapter Cable, bulkhead console speed, 3'	\$66.51
17917	Proximity Sensor, w/ 6" lead	\$175.00
13096	Speed/Flow Sensor, Hall-effect w/ MP shroud, 5'	\$132.96
14536	Molded Shaft Adapter Kit, w/ 10 magnets	\$78.00
14793	Bulkhead Console Run/Hold Adapter Cable	\$99.69
18541	Run/Hold Sensor Kit, whisker switch w/ magnetic mount, 10' extension cable	\$366.57
18529 A	Run/Hold Sensor Kit, whisker switch, (no magnetic mount)	\$294.92
18530 A	Magnet Mount for Implement Whisker Switch	\$129.75
14519	Run/Hold Foot Switch, w/ cable	\$300.13
13226	Run/Hold Sensor Cable, 5'	\$95.76
21963	Run/Hold Switch Assembly, SprayMate™ II, MT-NH3™ II, GSC-1000™	\$116.29
21778	Run/Hold Switch Assembly, SprayMate™ Plus, RoadMaster™, DrillMaster™	\$116.30
10013	Mount Bracket for speed and run/hold sensor	\$16.97
10080	Magnet Clip	\$11.19
12069	Magnet Kit, 6 magnets	\$18.33

**MISCELLANEOUS**

12853	Weatherproof Fuse Holder w/o fuse	\$28.80
12910	Plastic Tie Kit, 14", (bag of 10)	\$12.78
12911	Hex Nut for Speed and Run/Hold Sensor, 3/8", (bag of 3)	\$7.37
12912	Magnet Kit, w/ tape (6 magnets)	\$28.54
13251	Hardware Bag	\$13.54
13270	Terminal Kit, w/ weatherproof fuse holder	\$94.21
14012	WeatherPak Fuse Holder, w/ leads, w/o fuse	\$42.64

# REPLACEMENT FLOWMETERS

## Turbine Flowmeters

22032	FM250 P Flowmeter, .08 to 1.6 GPM, 290 PSI, 1/4" NPT and 1/2" HB, IXEF & SS _____	\$635.00
13269	FM500 Flowmeter, .5-5 GPM, 500 PSI, 1/2" FPT, PP & Hastelloy _____	\$494.00
11501	FM750 GFN Flowmeter, 2-40 GPM, 150 PSI, 3/4" FPT, nylon & Hastelloy _____	\$494.00
10131	FM750 SS Flowmeter, 2-40 GPM, 500 PSI, 3/4" FPT, SS & nylon & Hastelloy _____	\$910.00
13752	FM750 SS Flowmeter, w/ ceramic bearings, 2-40 GPM, 500 PSI, 3/4" FPT _____	\$910.00
17887 D	FM750 GFN LF Flowmeter, .5-12 GPM, 150 PSI, 3/4" FPT, nylon & Hastelloy _____	\$616.00
18599 A	FM750 LF SS Flowmeter, 1 - 9 gpm, 500 PSI, 3/4" FPT, SS & nylon & Hastelloy _____	\$1,031.00
13187	FM1000 SS Flowmeter, 3.5-70 GPM, 500 PSI, 1" FPT, SS & nylon & Hastelloy _____	\$988.00
14286 C	FM270 Flowmeter, 3.5-70 GPM, 225 PSI, M200 flange, PP, SS, nylon & Hastelloy _____	\$827.00
14286-P A	FM270 P Flowmeter, 3.5-70 GPM, 225 PSI, M200 flange, PP, SS, nylon & Hastelloy _____	\$527.00
18781 A	FM270 LF Flowmeter, .5-15 GPM, 225 PSI, M200 flange, PP, SS, & nylon & Hastelloy _____	\$888.25
18781-P B	FM270 P LF Flowmeter, .5-15 GPM, 225 PSI, M200 flange, PP, SS, & nylon & Hastelloy _____	\$584.00
14829-P A	FM10/100 P Flowmeter, 10-100 GPM, 225 PSI, M200 flange, SS, PP & nylon & Hastelloy _____	\$562.00
14348 E	FM1500 SS LF Flowmeter, 3.5-70 GPM, 500 PSI, 1 1/2" FPT, SS & nylon & Hastelloy _____	\$1,365.00
14348-P B	FM1500 P SS LF Flowmeter, 3.5-70 GPM (13-265 lpm) 500 PSI (35 Bar) _____	\$1,020.00
12274 C	FM1500 SS Flowmeter, 10-130 GPM, 500 PSI, 1 1/2" FPT, SS & nylon & Hastelloy _____	\$1,308.00
12274-P A	FM1500 P SS Flowmeter, 10-130 GPM (40-500 lpm) 500 PSI (35 Bar) _____	\$981.00
18078	FM2000 P Flowmeter, 19-198 GPM, 285 PSI, M200 flange, nylon & SS & ceramic _____	\$1,513.00
18229	FM3000 P Flowmeter, 40-396 GPM, 285 PSI, 3" MPT, nylon & SS & ceramic _____	\$1,988.00
10899	FM750 SS for NH3 Flowmeter, 2-40 GPM, 500 PSI, 3/4" FPT, SS & nylon Hastelloy _____	\$1,108.95
19797 A	FM750 LF SS for NH3 Flowmeter, 1 - 9 GPM, 500 PSI, 3/4" FPT, SS & nylon & Hastelloy _____	\$1,245.82
19798	FM1500 SS for NH3 Flowmeter, 10-130 GPM, 500 PSI, 1 1/2" FPT, PP & nylon & Hastelloy _____	\$1,653.78
19799 A	FM1500 SS LF for NH3 Flowmeter, 3.5-70 GPM, 500 PSI, 1 1/2" FPT, SS & nylon & Hastelloy _____	\$1,721.18

## Electromagnetic Flowmeters

18893	MM2 Flowmeter, .08 to 1.6 GPM, 290 PSI, 3/4" FPT, PP & SS _____	\$2,061.37
18448	MM3 Flowmeter, .13 to 2.6 GPM, 290 PSI, 3/4" FPT, PP & SS _____	\$2,061.37
18449	MM5 Flowmeter, .3 to 5 GPM, 290 PSI, 3/4" FPT, PP & SS _____	\$2,061.37
18450	MM13 Flowmeter, .6 to 13 GPM, 290 PSI, 3/4" FPT, PP & SS _____	\$2,061.37
18451	MM26 Flowmeter, 1.3 to 26 GPM 290 PSI, 1" FPT, PP & SS _____	\$2,061.37
18452	MM53 Flowmeter, 2.6 to 53 GPM, 290 PSI, 1" FPT, PP & SS _____	\$2,061.37
18453	MM106 Flowmeter, 5 to 106 GPM, 290 PSI, 1 1/2" FPT, PP & SS _____	\$2,061.37
19828	MM106FL Flowmeter, 5 to 106 GPM, 290 PSI, M220 flange, PP & SS _____	\$2,061.37
18454	MM158 Flowmeter, 8 to 158 GPM, 290 PSI, 2" MPT, PP & SS _____	\$2,061.37
18177	MM238 Flowmeter, 12 to 238 GPM, 290 PSI, 2" MPT, PP & SS _____	\$1,558.99
16161 A	MM528 Flowmeter, 26.5 to 528 GPM, 145 PSI, 3" MPT, PP & SS _____	\$1,558.98

## Micro-Trak Flowmeter Parts

10137	Gasket, teflon, FM750 SS & N and FM1000 SS _____	\$8.53
10605	O-Ring, FM500 _____	\$5.79
13783	O-Ring, quad for FM750 GFN _____	\$27.98
18996	O-Ring for FM750 LF GFN insert _____	\$2.01
11277	Bearing Assembly Rebuild Kit w/ ruby balls for FM750 SS, FM1000 SS and FM1500 SS, w/o turbine _	\$100.49
13753	Bearing Assembly Rebuild Kit w/ ceramic balls for FM750 SS, FM1000 SS and FM1500 SS, w/o turbine_	\$104.08
17144	Bearing Assembly Rebuild Kit w/ ruby balls for FM750 SS, FM1000 SS and FM1500 SS, w/ turbine__	\$192.51
17147	Bearing Assembly Rebuild Kit w/ ceramic balls for FM750 SS, FM1000 SS and FM1500 SS, w/ turbine__	\$192.51
17302	Bearing Assembly Rebuild Kit w/ ruby balls for FM270 and FM10/100/ w/ turbine_____	\$168.31
19795	Bearing Assembly Rebuild Kit w/ ruby balls for FM750 SS NH3, w/ turbine _____	\$305.16
19813	Bearing Assembly Rebuild Kit w/ ruby balls for FM1500 SS NH3, w/ turbine _____	\$311.21
16165 A	Rebuild Kit for FM1500 PA, w/ turbine, for NH3 _____	\$361.73
14836	Turbine for FM750 GFN, SS, FM1000 SS, FM270, FM10/100 and FM1500 SS _____	\$155.84
17885	Turbine for FM750 LF, FM270 LF and FM1500 LF _____	\$157.37
19875	Rebuild Kit for FM1500 NH3 Bearing Housing, SS, w/ bearing for NH3 _____	\$369.96
13434	VRS Interface Module _____	\$271.46
17884 A	FM750 LF GFN Insert _____	\$64.47
18922	Bearing Assembly Rebuild Kit for Bearing Housing w/bearing for FM270, FM10/100, & FM1500 ____	\$320.81
15894 A	Bearing Assembly Rebuild Kit for Poly Bearing Housing w/bearing for FM270, FM10/100, FM1500 _	\$187.34
19059	Flange Gasket and Clamp Kit, 2", (2 ea.) _____	\$53.14

Replacement Flowmeters, cont.

19770	Adapter Kit, 2" full port Banjo flange, for mag. fl. kits 01826, 01827 _____	\$38.78
19771	Adapter Kit, 2" STD port Banjo flange, for mag. fl. kit 01901,01821,01822,01823,01824,01825 ____	\$45.25
20182	FM500 Rotor, PP, w/ Nivapoint Shaft _____	\$114.86
16131 A	FM750 GFN Housing Half, w/ bearing, (one half of flowmeter) _____	\$253.00
16132 A	FM750 GFN LF Housing Half, w/ bearing, (one half of flowmeter) _____	\$309.00

**Polmac Flowmeter Parts**

11259-01	Polmac FM2000P & 3" Sensor, green _____	\$372.49
11259-02	Polmac Seeger Ring #48, 2" _____	\$20.09
11259-03	Polmac Tunnel, 2" _____	\$69.00
11259-04	Polmac Shaft Holder, 2" _____	\$16.09
11259-05	Polmac Turbine Shaft, 2" _____	\$17.41
11259-06	Polmac Seeger Ring #10, 2" _____	\$17.41
11259-07	Polmac Flowmeter Rotor Bearing, 2" _____	\$88.41
11259-08	Polmac Flowmeter Spacer Washer, 2" _____	\$18.75
11259-09	Polmac SS Turbine, 2" _____	\$494.30
11259-10	Polmac Flowmeter Housing, 2" _____	\$390.68
11259-11	Polmac Rotor Shaft, ceramic _____	\$88.41
11259-12	Polmac Rotor Bushing, ceramic _____	\$31.60
11259-13	Polmac Rotor Support, ceramic _____	\$178.16
11259-14	Polmac Rotor Support, nylon _____	\$14.74
11259-15	Polmac Flow Sensor, sq. wave, yellow _____	\$278.69
12414-01	Polmac Rotor Repair Kit, ceramic, 3" _____	\$495.69
12414-02	Polmac Flow Sensor, sinusoidal, 3", green _____	\$396.47
12414-03	Polmac Flowmeter Turbine, 3" _____	\$1,198.91
12414-04	Flowmeter Rotor Shaft, ceramic, 3' _____	\$88.41

**FLOW SENSOR CABLES**

13096	Speed/Flow Sensor, Hall-effect w/ MP shroud, 5' _____	\$132.96
14689	Flow Sensor, Hall-effect, 3-pin WP _____	\$130.36
17392	Speed/Flow Sensor, Hall-effect w/ MP shroud, 1' _____	\$102.41
18076	Speed/Flow Sensor, Hall-effect w/ Cannon connector, Hiniker _____	\$143.47
17965	Reed Flow Sensor for FM750 GFN Flowmeter (P/N 11501) _____	\$85.72
18205	Flow Sensor for FM2000 and FM3000 polmac flowmeters _____	\$504.66
19425 A	Flow Sensor for FM250 P polmac flowmeter _____	\$329.28
18105	Adapter Cable for old style polmac square wave sensor, MP shroud, 3' _____	\$189.30
20268	Adapter Cable for old style polmac analog sensor, WP shroud, 3' _____	\$189.30
17827 A	Adapter Cable for electro-magnetic flowmeter, w/ divide by 8 interface _____	\$213.58
17842	Adapter Cable for electro-magnetic flowmeter w/o divide by 8 interface _____	\$95.34
16004 A	Adapter Cable, electro-magnetic flowmeter to Raven interface cable, 10' _____	\$246.15
16005 A	Adapter Cable, electro-magnetic flowmeter to John Deere® interface cable, 10' _____	\$105.15
16006 A	Adapter Cable, electro-magnetic flowmeter to TeeJet® interface cable, 10' _____	\$124.80
01756	Flow Sensor Kit for Honeywell flow sensor _____	\$551.42

**FLOW CONTROL (SERVOS, CONTROL VALVES & PARTS)**

19059	Flange Gasket and Clamp Kit, 2", (2 ea.) _____	\$53.14
19104 A	Liquid Servo Valve Replacement Powerhead (Viton), 2016-current _____	\$405.00
19503 A	Liquid Servo Valve Replacement Powerhead, aqueous ammonia w/EPDM o-rings, 2016-current _____	\$405.00
19505	NH3 Servo Valve Replacement Powerhead, 2016-current _____	\$542.00
19811	NH3 Servo Valve Replacement Powerhead, retrofit 2005 model _____	\$542.00

**EMD Parts**

18104 C	Electric Motor Driver Module, 10 Amp PWM _____	\$390.07
18072 B	Electric Motor Driver Module, 10 Amp STD _____	\$390.07
18924 B	Electric Motor Driver Module, 10-Amp PWM w/ enable _____	\$393.97
18137	Power Cable, 3-pin WP, 10 Amp fuse, 20' _____	\$143.66
18941	Motor Lead, 2-pin WP, 4' _____	\$38.19
14501	Motor Lead Extension Cable, 2-pin WP, 10 Amp EMD, 5' _____	\$74.25
18385	Electric Motor Driver Module, 40 Amp PWM <b>CE UK</b> _____	\$808.09
18384	Electric Motor Driver Module, 40 Amp STD <b>CE UK</b> _____	\$808.09
18925	Electric Motor Driver Module, 40-Amp PWM w/ enable <b>CE UK</b> _____	\$814.06

*Flow Control (Servos, Control Valves & Parts), cont.*

18419	Power Cable, 2-pin MP 480 Power, 20' w/ 40 Amp fuse _____	\$244.94
18420	Motor Lead , 2-pin MP 480, 4' _____	\$72.18
17539	Adapter Cable, MT servo to PWM valve _____	\$45.51
17279	Adapter Cable, EMD enable _____	\$25.86
19731	Adapter Cable, 2-pin PWM, control signal reversal adapter _____	\$30.03
17871	Power Cable, 2-pin MP 280, w/ 40 Amp fuse, old style 40 Amp EMD, 20' _____	\$255.00
17872	Motor Lead, 2-pin MP 280, old style 40 Amp EMD, 4' _____	\$69.22
19087	Relay Module, single relay _____	\$266.22
18990 C	Relay Module, dual relays _____	\$364.57
18034	Adapter Cable, EMD enable for SprayMate™ II (enable signal when all sections are off) _____	\$114.85
01725	EMD Enable Kit for MT-3405™ series (enable signal when all sections are off) _____	\$565.00

## MISCELLANEOUS ADAPTER CABLES

14793	Bulkhead Console Run/Hold Adapter Cable _____	\$99.69
17108	Adapter Cable, Rawson/Mid-Tech flow sensor, 1' _____	\$48.83
14469	Solenoid Adapter Cable, 3-Pin WPS to 1/4" QD _____	\$34.89
19088	Adapter Cable, PWM hydraulic control, 3-Pin WP tower to 2-Pin Deutsch DT06-2S, 6" _____	\$56.86
19897	Adapter Cable, PWM hydraulic control, 3-Pin WP tower to 2-Pin Deutsch DT06-2S, 10' _____	\$68.54
17539	Adapter Cable, MT servo to PWM valve _____	\$45.51
17934	Adapter Cable, servo polarity reversal _____	\$35.88
18287	Adapter Cable, 3-pin WPS to WPS _____	\$48.12
18851	Adapter Cable, TeeJet® flow sensor (adapts a Teejet® flow sensor to MT flow input) _____	\$79.69
17846	*Adapter Cable, hydraulic poppet, 3-pin WPS to 2-pin MP tower _____	\$32.67
19016	Adapter Cable, 3-pin WPS section to 2-pin WPT solenoid _____	\$36.75
14778	Adapter Cable, 3-pin MPS, pins A & C to flying leads generic run/hold adapter, 30' _____	\$69.00
19731	Adapter Cable, 2-pin PWM control signal reversal adapter _____	\$30.03
19952	M12 Adapter Cable, WPS-PGS _____	\$138.44
19954	M12 Adapter Cable, MPS-PGS _____	\$135.90
15854 A	Adapter Cable, 4-wire control valve _____	\$89.83
15855 A	Adapter Cable Kit, 4-wire control valve (w/14315C power cable) _____	\$195.24

## SPEED ADAPTER CABLES

### Astro™ Adapter Cables

17338	Astro™ Adapter, 3-pin MP to MT-3000/5000 3-pin WP _____	\$84.75
17433	Astro™ Adapter, 4-pin AMP to 3-pin MP _____	\$268.95
17536	Astro™ Adapter, 3-pin WP to 3-Pin MP _____	\$54.90
18279	Astro™ Adapter, 3-pin MP to Raven/Dickey JOHN®/Amp Y-cable _____	\$158.90
18602	Astro™ Adapter, 3-pin MP to 3-pin MP/Dickey JOHN®/AMP Y-cable _____	\$158.90

### Radar Adapter Cables

14810	Radar Adapter for in-cab John Deere® MP 150 connector _____	\$73.00
14811	Radar Adapter for in-cab John Deere® MP 150 connector w/ Y-cable _____	\$84.00
14812	Radar Adapter for Dickey JOHN®/AMP connector w/ Y-cable _____	\$152.00
14813	Radar Adapter for Dickey JOHN®/Cannon connector w/ Y-cable _____	\$152.00
14814	Radar Adapter for Dickey JOHN®/Deutsch connector w/ Y-cable _____	\$152.00
14815	Radar Adapter for Dickey JOHN®/Packard connector w/ Y-cable _____	\$152.00
14816	Radar Adapter for Dickey JOHN®/Ford connector w/ Y-cable _____	\$152.00
14817	Radar Adapter for Raven/Conxall connector w/ Y-cable _____	\$152.00
19906	Radar Adapter for Raven/Conxall _____	\$90.00
14818	Radar Adapter for Magnavox/Phillips/Packard connector w/ Y-cable _____	\$152.00
14926	Radar Adapter, 4-pin DJ to 3-pin MPS (Vansco®) _____	\$84.00
17811	Radar Adapter for in-cab John Deere® 30 Series 7-pin Amp _____	\$152.00
18041	Radar Adapter for in-cab John Deere® 1-pin MP280 _____	\$32.00
18319	Radar Adapter for in-cab Case IH® MX (Britax) _____	\$152.00
18774	Radar Adapter for in-cab Case IH® FMX _____	\$152.00

\*NCNR

# ASTRO™ SERIES GPS SPEED SENSORS - OTHER MAKES & MODELS

## Astro™ II GPS Speed Sensors (1 Hz)

01413	Astro™ II, w/ 4-pin Dickey JOHN®/AMP _____	\$529.00
01414	Astro™ II, w/ 4-pin Dickey JOHN®/Packard _____	\$529.00
01415	Astro™ II, w/ 3-pin Raven/Conxall _____	\$529.00
01416	Astro™ II, w/ 4-pin Magnavox/Phillips/Packard _____	\$529.00
01417	Astro™ II, w/ 3-pin Spraying Systems #844/Deutsch _____	\$529.00
01419	Astro™ II, w/ 3-pin Spraying Systems #855/Deutsch (round shell) _____	\$529.00
01420	Astro™ II, w/ 3-pin Hiniker/Cannon _____	\$579.00
01847	Astro™ II, w/ 3-pin Amp Superseal (HARDI) _____	\$529.00

## Astro™ 5 GPS Speed Sensors (5 Hz)

01428	Astro™ 5, w/ 4-pin Dickey JOHN®/AMP _____	\$707.00
01429	Astro™ 5, w/ 4-pin Dickey JOHN®/Packard _____	\$707.00
01430	Astro™ 5, w/ 3-pin Raven/Conxall _____	\$707.00
01431	Astro™ 5, w/ 4-pin Magnavox, Phillips/Packard _____	\$707.00
01432	Astro™ 5, w/ 3-pin Spraying Systems #844/Deutsch _____	\$707.00
01433	Astro™ 5, w/ 3-pin Spraying Systems #855/Deutsch (round shell) _____	\$707.00
01435	Astro™ 5, w/ 3-pin Hiniker/Cannon _____	\$754.00
01848	Astro™ 5, w/ 3-pin Amp Superseal, (HARDI) _____	\$707.00

# RADAR INTERFACE CABLES

## Radar Interface Cables - Adapts Signal for Older Controllers ("Divide by 8")

14214	Radar Interface for in-cab John Deere® MP 150 connector _____	\$127.00
14215	Radar Interface for Dickey JOHN®/AMP connector _____	\$192.00
14216	*Radar Interface for Dickey JOHN®/Cannon connector _____	\$192.00
14217	Radar Interface for Dickey JOHN®/Deutsch connector _____	\$192.00
14218	Radar Interface for Dickey JOHN®/Ford connector _____	\$192.00
14219	Radar Interface for Dickey JOHN®/Packard connector _____	\$192.00
14220	Radar Interface for Magnavox, Phillips/Packard connector _____	\$192.00
14221	Radar Interface for Raven/Conxall connector _____	\$192.00
14222	Radar Interface for in-cab John Deere® MP 150 connector with y-cable _____	\$192.00
17880	Radar Interface for in-cab John Deere® 30 Series 7-pin Amp for LR products _____	\$199.76

## Radar Y-Cables (For use with P/N 12758 Interface Modules)

11527	Y-Cable for Dickey JOHN®/AMP radar, 1' _____	\$370.63
11529	Y-Cable for Magnavox, Phillips radars, 1' _____	\$172.43
11693	Y-Cable for Dickey JOHN®/Packard radar, 1' _____	\$239.80
12095	Y-Cable for Raven radar, 1' _____	\$269.31
12689	*Y-Cable for Dickey JOHN®/Ford radar, 1' _____	\$211.17
12798	*Y-Cable for Dickey JOHN®/Deutsch radar, 1' _____	\$298.05

## Radar Interface Adapter Cables (For use with P/N 12758 Interface Modules)

11461	Radar Module Adapter Cable, (84C, FT 84C, FT 96C, 86S, YT 85) _____	\$46.19
12817	USIM Wire Assembly, 2-pin, 5' _____	\$23.51
12953	Adapter Cable for in-cab John Deere® 8000 & 9000 Series, 1.5' _____	\$79.96
17789	Adapter Cable for in-cab John Deere® 30 Series, 7-pin Amp _____	\$152.00

## Radar Power Cables

11528	Power Cable for Dickey JOHN®/AMP radar, 6' _____	\$140.74
11530	Power Cable for Magnavox, Phillips radars, 6' _____	\$137.41
12690	*Power Cable for Dickey JOHN®/Ford radar, 6' _____	\$138.73
12800	Power Cable for Dickey JOHN®/Deutsch radar, 6' _____	\$137.38

## Vansco® Radar Parts and Adapter Cables

14019 B	Radar Interface Cable, 4-pin DJ to 3-pin MP, Vansco® _____	\$129.00
14025	Radar Interface Cable, 4-pin DJ to 3-pin WP, Vansco® _____	\$127.00
14026	*4-pin DJ Amp to Dickey JOHN®/Cannon connector, 1' _____	\$172.00
14027	4-pin DJ Amp to Dickey JOHN®/Packard connector, 1' _____	\$172.00
14028	*4-pin DJ Amp to Dickey JOHN®/Deutsch connector, 1' _____	\$172.00
14029	4-pin DJ Amp to Magnavox/Packard connector, 1' _____	\$172.00
14030	4-pin DJ Amp to Raven/Conxall connector, 1' _____	\$172.00
14031	*4-pin DJ Amp to Spraying Systems/Deutsch connector, 1' _____	\$172.00
14039	4-pin DJ Amp to Dickey JOHN®/Ford connector, 1' _____	\$172.00
14380	Cable for John Deere® Performance Center (7000, 8000, 9000, Track Series), 1' _____	\$172.00
17389	Radar Mount Kit (new style), Vansco® _____	\$59.74

\*NCNR



## RAVEN ADAPTER CABLES

14611	Adapter Cable, Raven flowmeter interface to MT, w/ 5V regulator, 18" 3-Pin Female Conxall to 3-Pin M/P 150 Shroud	\$262.11
18664	Adapter Cable, Raven flowmeter interface to MT, no regulator, 18" 3-Pin Female Conxall to 3-Pin M/P 150 Shroud	\$146.46
17528	Adapter Cable, Raven servo valve (old style) to MT, 8" 3-Pin W/P 120 Tower to 2-Pin Molded Male	\$50.16
17324	Adapter Cable, MT servo to Raven (old style), 1' 3-Pin W/P Shroud to 2-Pin Molded Male	\$67.00
17325	Adapter Cable, MT flow/speed sensor w/ 3 pin MP to Raven/Conxall, 1' 3-Pin Male Conxall to 3-Pin M/P 150 Tower	\$108.00
19905	Adapter Cable, MT to Raven NH3 fast valve, 7" 4-Pin Conxall Multi-Connection Socket to 3-Pin W/P Tower and 3-Pin W/P Shroud	\$274.88
19906	Adapter Cable, MT console to Raven Fast Valve, 3 pin M/P 150 shroud to 3 pin Conxall, 7" 3-Pin Female Conxall to 3-Pin M/P 150 Shroud	\$90.00
19907	Adapter Cable, MT to Raven NH3 fast valve AND Raven NH3 shut-off, 7" 4-Pin Conxall Multi-Connection Socket to 3-Pin W/P 120 Shroud and 4-Pin Conxall Multi-Connection Socket to 3-Pin W/P 120 Tower	\$413.99
16002 A	Adapter Cable, MT control valve to Raven, 9"	\$139.72
16003 A	Adapter Cable, MT on/off KZ Valve® to Raven, 9"	\$142.62
17442 B	MT Hall-effect flow/speed sensor to Raven, 9" 3-Pin Male Conxall to Hall-Effect Sensor	\$158.70
16088 A	Adapter Cable, MT to Raven shutoff	\$192.40
16153 A	Adapter Cable, Dual ISOMod™ to Raven 440, w/CPC conn.	\$1,081.31

## FLOWMETER KITS WITH FLOW SENSOR THAT CONNECTS TO RAVEN

01980	FM270 LF Flowmeter Kit, .5-15 GPM, 225 PSI, M200 flange, PP, SS & nylon & Hastelloy	\$989.00
01980-P A	FM270 LF Flowmeter Kit, .5-15 GPM, 225 PSI, M200 flange, PP & nylon & Hastelloy	\$693.00
01577	FM270 Flowmeter Kit, 3.5-70 GPM, 225 PSI, M200 flange, PP, SS & nylon & Hastelloy	\$919.84
01577-P A	FM270 Flowmeter Kit, 3.5-70 GPM, 225 PSI, M200 flange, PP & nylon & Hastelloy	\$645.00
01578 A	FM10/100 Kit, 10-100 GPM, 225 PSI, M200 flange, PP, SS & nylon & Hastelloy	\$919.84
01578-P A	FM10/100 Kit, 10-100 GPM, 225 PSI, M200 flange, PP & nylon & Hastelloy	\$667.00
02028	FM1500 SS Flowmeter Kit, NH3, 10-130 GPM, 500 PSI, 1 1/2" FPT, SS & nylon & Hastelloy	\$1,355.00
02029	FM1500 SS LF Flowmeter Kit, NH3, 3.5-70 GPM, 500 PSI, 1 1/2" FPT, SS & nylon & Hastelloy	\$1,418.00

## SERVO VALVES WITH RAVEN CONNECTIVITY

16129 A	Servo Valve, M200 flanged or 1 1/2" FPT w/ 1" butterfly, Raven, 2 pin molded	\$627.00
16130 A	Servo Valve, M200 flanged or 1 1/2" FPT w/ 1 1/2" butterfly, Raven, 2 pin molded	\$627.00
16148 A	Servo Valve, M200 flanged or 1 1/2" FPT w/ 1" butterfly, Deutsch, 2 pin molded	\$627.00
16149 A	Servo Valve, M200 flanged or 1 1/2" FPT w/ 1 1/2" butterfly, Deutsch, 2 pin molded	\$627.00

## Y CABLES

17501	Y Cable, 2 Pin MP 280, 1 Shroud & 2 towers, 20', (25 Amp MC dual motor)	\$122.75
18422	Y Cable, 2 Pin MP 480, 1 Shroud & 2 towers, 2', (40 Amp EMD dual motor)	\$132.31
13872	Y Cable, 3 Pin MP 150, 1 Tower & 2 shrouds, 12', (1 - speed signal in & 2 - out)	\$187.20
18048	Y Cable, 3 Pin MP 150, 1 Shroud & 2 towers, 12', (2 - R/H switches in & 1 - out)	\$99.86
16031 A	Y Cable, 2 Pin MP 150, 1 Shroud & 2 towers, 10', (7-section RateKing™ parallel boom)	\$83.00

## CONSOLE MOUNT KITS AND PARTS

10049	Console Mount Bracket, 82A - 84C size consoles	\$13.92
10050	Console Mount Washer, 82A, 84C size consoles	\$3.15
10051	Console Mount Knob, 82A - 84C size consoles	\$6.09
12888	Console Mount Knob, any black plastic consoles	\$7.17
12889	Console Mount Washer, any black plastic consoles	\$2.96
13181	Console Mount Kit, any black plastic consoles	\$34.97
10423	Console Mount Knob, RateKing™ or aluminum consoles measuring 8 - 11/16"	\$10.50
10470	Console Mount Washer, RateKing™ or aluminum consoles measuring 8 - 11/16"	\$5.71
13629 B	Console Mount Bracket, RateKing™ or aluminum consoles measuring 8 - 11/16"	\$24.11
13774	Console Mount Kit, RateKing™ or aluminum consoles measuring 8 - 11/16"	\$75.73
13254	Console Mount Kit, MT-9000™ series	\$66.75
19960 A	Console Quick Mount kit, SprayMate™ XRS or any black plastic consoles	\$105.50

## CONSOLES AND ISOMODS™

17185 A	Calc-An-Acre™ II Console _____	\$478.00
14966 J	SodPro™ II Console _____	\$777.00
14914	Shaft-Trak™ Console (low RPM) _____	\$652.00
14381	Shaft-Trak™ Console (standard) _____	\$652.00
18473	SafeGuard™ Console _____	\$1,135.00
17186 A	Flow-Trak™ II Console _____	\$865.00
19836 B	Flo-Pro™ Console _____	\$1,164.00
17996	MC-10 Manual Controller only, 10 amp _____	\$274.00
17997	MC-25 Manual Controller only, 25 amp _____	\$567.00
14935	MT-2405™ II Console _____	\$799.00
17546 P	RoadMaster™ Console (PWM control) _____	\$1,959.00
17514 R	RoadMaster™ Console (standard control) _____	\$1,959.00
14869 P	SprayMate™ II Console _____	\$998.00
18700 C	SprayMate™ Plus Console _____	\$1,496.00
19884 C	RateKing™ XRS Console _____	\$2,644.00
19955 D	SprayMate™ XRS Console _____	\$1,871.00
18715 A	RateKing™ Plus Console, 3 section _____	\$1,806.00
18701 B	RateKing™ Plus Console, 5 section _____	\$1,806.00
18716 C	RateKing™ Plus Console, 7 section _____	\$2,127.00
18717 A	RateKing™ Dual Plus Console, 3 section _____	\$3,109.00
18702 A	RateKing™ Dual Plus Console, 5 section _____	\$3,109.00
18718 A	RateKing™ Dual Plus Console, 7 section _____	\$3,592.00
17011 L	GSC-1000™ Console, PWM control _____	\$1,536.00
17010 M	GSC-1000™ Console, STD control _____	\$1,536.00
14956 B	MT-NH3™ II Console _____	\$1,455.00
17766	Trak-Record II Console _____	\$966.69
01375	*Whirlwind™ Console Kit _____	\$1,052.00
17289 H	ProPlant™ Console _____	\$1,882.00
18797 C	SafeGuard™ ISOmod™ Module _____	\$886.34
19667 A	Dual ISOmod™ Module _____	\$2,128.00
17899 G	DrillMaster™ Console _____	\$1,366.00
18154 A	FlowMate™ Console _____	\$473.00

## SYSTEM MANUALS & INSTRUCTION SHEETS (NET PRICE ONLY)

10154	System Manual, Calc-An-Acre™ 84C _____	\$15.23 NET
17192	System Manual, Calc-An-Acre™ II _____	\$15.23 NET
13184	System Manual, Calc-An-Acre™ LR _____	\$15.23 NET
12813	System Manual, Flow-Trak™ FT84C, FT96C _____	\$15.23 NET
17193	System Manual, Flow-Trak™ II _____	\$15.23 NET
12245	System Manual, MT-3000™ _____	\$15.23 NET
14904	System Manual, MT-2405 F™ II, (NH3 Specific) _____	\$15.23 NET
13773	System Manual, MT-3405 F™ _____	\$15.23 NET
17020	System Manual, MT-3405™ FTW II _____	\$15.23 NET
14946	System Manual, MT-3405 F™ II, (NH3 Specific) _____	\$15.23 NET
18080	System Manual, Twin Pump™ Controller _____	\$15.23 NET
13255	System Manual, MT-9000™ _____	\$15.23 NET
13797	System Manual, MT-9000™, (NH3 Specific) _____	\$15.23 NET
17545	System Manual, RoadMaster™, PWM _____	\$15.23 NET
17544	System Manual, RoadMaster™, STD _____	\$15.23 NET
14943	System Manual, SprayMate™ II _____	\$15.23 NET
18770 A	System Manual, SprayMate™ Plus, (2014 to current) _____	\$15.23 NET
18209	System Manual, SprayMate™ Plus, (prior to 2014) _____	\$15.23 NET
19862	System Manual, RateKing™ XRS _____	\$15.23 NET
19959 A	System Manual, SprayMate™ XRS _____	\$14.94 NET
18836 B	System Manual, RateKing™ Dual Plus _____	\$14.94 NET
18844	System Manual, SafeGuard™ ISOmod™ _____	\$15.23 NET
18864 A	System Manual, RateKing™ Plus _____	\$15.23 NET
19603 B	System Manual, Dual ISOmod™ _____	\$15.23 NET

\*NCNR

*System Manuals & Instruction Sheets, cont.*

17040	System Manual, GSC-1000™ _____	\$15.23 NET
14955	System Manual, MT-NH3™ II _____	\$15.23 NET
13604	System Manual, MT-NH3™ _____	\$15.23 NET
17767	System Manual, Trak-Record II _____	\$15.23 NET
14479	System Manual, Whirlwind™ _____	\$15.23 NET
19830	System Manual, Flo-Pro™ _____	\$15.23 NET
17329	System Manual, ProPlant™ _____	\$15.23 NET
17037	System Manual, SodPro™ II _____	\$15.23 NET
50052 A	Instruction Sheet, 7 section Parallel Boom Cable _____	\$8.51 NET
50318	System Manual, DrillMaster™ _____	\$15.23 NET
50173	Safety Manual, NH3 _____	\$15.23 NET
50346	Instruction Sheet, FlowMate™ _____	\$8.51 NET
50332	Instruction Sheet, MC-10 Manual Controller _____	\$8.51 NET
50236	Instruction Sheet, MC-25 Manual Controller _____	\$8.51 NET
50271	Instruction Sheet, MT-3407 F™ II _____	\$8.51 NET
50209	Instruction Sheet, Shaft-Trak™ _____	\$8.51 NET
50268	Instruction Sheet, Vansco® Radar _____	\$8.51 NET
50279	Instruction Sheet, Raven 440/450 NH3 DirectConnect™ _____	\$8.51 NET
50291	Instruction Sheet, Raven 440/450 Liquid DirectConnect™ _____	\$8.51 NET
50314	Instruction Sheet, Ag Leader® Insight Liquid DirectConnect™ _____	\$8.51 NET
50328	Instruction Sheet, Ag Leader® Insight NH3 DirectConnect™ _____	\$8.51 NET
50355	Instruction Sheet, Starter Fertilizer Pump Relay kit _____	\$8.51 NET
50360	Instruction Sheet, Trimble® Field-IQ™ Liquid & NH3 DirectConnect™ _____	\$8.52 NET
50362	Instruction Sheet, 40A PWM EMD _____	\$8.51 NET
50368	Instruction Sheet, John Deere® GreenStar™ Liquid & NH3 DirectConnect™ _____	\$8.51 NET
50371	System Manual, SafeGuard™ Console _____	\$8.51 NET
50374	Instruction Sheet, 8 GPM PWM Hydraulic Valve _____	\$8.51 NET
50375	Instruction Sheet, SafeGuard™ Demo Display _____	\$8.51 NET
50377	Instruction Sheet, NH3500™ Low Rate Conversion kit _____	\$8.51 NET
50380	Instruction Sheet, Shaft-Trak™ Low RPM _____	\$8.51 NET
50382	Instruction Sheet, 15 GPM PWM Hydraulic Valve _____	\$8.51 NET
50383	Instruction Sheet, MC-10 w/Power Output _____	\$8.51 NET
50384 A	Instruction Sheet, 10A PWM EMD w/Enable _____	\$8.51 NET
50385	Instruction Sheet, 40A PWM EMD w/Enable _____	\$8.51 NET
50393	Instruction Sheet, Liquifier Jr. Upgrade kit _____	\$8.51 NET
50397	Instruction Sheet, ISOmod™ Power Switch Module kit _____	\$8.51 NET
50400	Instruction Sheet, ISOmod™ Magnet Mount kit _____	\$8.51 NET
50402	Instruction Sheet, Liquifier Max Vapor Fitting Install _____	\$8.51 NET
50404	Instruction Sheet, NH3 Servo Valve Gear Head Replacement _____	\$8.51 NET
50406 B	Instruction Sheet, SprayMate™ Plus to Raven 440 Adapter, w/CPC female connector _____	\$8.34 NET
50414 A	Instruction Sheet, SprayMate™ Plus™ to Raven 440 Adapter, w/CPC male (old style) _____	\$8.51 NET
50415 A	Instruction Sheet, Magnetic Flowmeter _____	\$8.51 NET
50421 A	Instruction Sheet, 25 GPM PWM Hydraulic Valve _____	\$8.52 NET

## DEMONSTRATION DISPLAYS

**Includes electronic display, console(s) and 110 volt power supply (net price only)**

01478	*Demonstration Display, SafeGuard™ _____	\$1,859.31 NET
01479	*Demonstration Display, RoadMaster™ _____	\$975.81 NET
01483	*Demonstration Display, Shaft-Trak™ _____	\$460.58 NET
01484	*Demonstration Display, GSC-1000™ _____	\$850.90 NET
01485	*Demonstration Display, MT-NH3™ II _____	\$858.70 NET
01488	*Demonstration Display, SprayMate™ II _____	\$866.51 NET
01489	*Demonstration Display, Calc-An-Acre™ II & Flow-Trak™ II _____	\$897.74 NET
01490	*Demonstration Display w/o console or adapter _____	\$616.71 NET
01495	*Demonstration Display, RateKing™ Plus _____	\$1,195.02 NET
01497	*Demonstration Display, RateKing™ Dual Plus _____	\$1,629.60 NET
01841	*Demonstration Display, SprayMate™ Plus _____	\$1,073.46 NET
01903	*Demonstration Display, SafeGuard™ Upgrade to ISOmod™ _____	\$362.00 NET

\*NCNR

02002	*Demonstration Display, SafeGuard™ Retrofit Kit (Update to Amphenol plugs) _____	\$378.00 NET
02003	*Demonstration Display, SafeGuard™ Retrofit Kit w/ISOmod™ (Amphenol plugs) _____	\$659.00 NET
40203	*Demonstration Display Adapter Cable, SprayMate™ II, RoadMaster™ _____	\$52.41 NET
40204	*Demonstration Display Adapter Cable, MT-2405™ F II _____	\$104.31 NET
40205	*Demonstration Display Adapter Cable, MT-3405 F™ II, MT-3405 D™, MT-9000™ _____	\$49.37 NET
40206	*Demonstration Display Adapter Cable, MT-NH3™ II _____	\$39.76 NET
40209	*Demonstration Display Adapter Cable, Calc-An-Acre™ II/Flow-Trak™ II _____	\$75.35 NET
40267	*Demonstration Display Adapter Cable, SprayMate™ Plus _____	\$48.81 NET
40311	*Demonstration Display Adapter Cable, RateKing™ Plus/Dual Plus _____	\$51.69 NET
40312	*Demonstration Display Adapter Cable, RateKing™ Dual Plus Channel 2 _____	\$38.76 NET
40238	*Demonstration Display Adapter Cable, SprayMate™ XRS _____	\$47.86 NET
40319 A	*Demonstration Display Indicator Light Assembly for Unit Multifunction _____	\$26.46 NET

## DIAGNOSTIC AND SERVICE TOOLS (NET PRICE ONLY)

13521	Crimping Tool, WP _____	\$220.85 NET
13522	Crimping Tool Kit, MP _____	\$288.85 NET
13523	Terminal Removal Tool, WP _____	\$18.74 NET
13524	Terminal Removal Tool, MP _____	\$18.74 NET
01462	Speed/Flow Simulator _____	\$200.00 NET
16200 A	ISOmod™ Programming Cable Kit, M/P 150 _____	\$88.00 NET
16199 A	ISOmod™ Adapter Cable , M/P 3-pin to DB9, 7" _____	\$88.64 NET
19951	Adapter Cable, USB to RS232 _____	\$106.23 NET

## DISCONTINUED MONITORS AND CONTROLLERS

### MT-3000™ and MT-5000™

10474	Compression Fitting Kit _____	\$46.72
11311	M-T Servo Valve Cable, w/ boost wire, 5' _____	\$81.39
10415	MT-3000™ Main Wiring Harness, liquid, 12' _____	\$504.30
11039	NH3 Main Harness (MT-3000) _____	\$416.29
11037	Plumbing Panel Harness (MT-3000, MT-5000, TN-7000), 3' _____	\$129.15
10485	Pressure Tubing Extension Kit, 15' _____	\$61.65
11203	Snubber Washer Kit, w/o-ring _____	\$21.40
10419 A	Solenoid Cable (MT-3000), 3' _____	\$48.69

### Calc-An-Acre™ - Models 82A & 84C

10073	Power Cable (82A), 8' _____	\$57.53
10085	Extension Cable for speed and run/hold (82A, 84C), 20' _____	\$96.41

### Flow-Trak™ - Models 84C - 96C

10085	Extension Cable for speed and run/hold (82A, 84C), 20' _____	\$96.41
10195	Extension Cable for flow sensor (FT 84C, FT 96C), 20' _____	\$96.39

### MT-3400™ Series

14469	Solenoid Adapter Cable, 3-Pin WPS to 1/4" QD _____	\$34.89
17436	Boom Branch Harness, MT-3405 F™ II, 10' _____	\$246.71
17419	Boom Branch Harness, MT-3407 F™ II, 10' _____	\$261.45
13115	Boom Shutoff/Relief Cable, 5' _____	\$41.74
17159 A	Bulkhead Console 5-boom 2-wire Ball Valve Adapter Cable _____	\$827.94
14319	Bulkhead Console Boom Branch Harness, 10' _____	\$282.01
14320	Bulkhead Console Flow, Servo, Run/Hold Harness, 10' _____	\$196.65
14318	Bulkhead Console Power Boom Harness, 10' _____	\$514.37
14793	Bulkhead Console Run/Hold Adapter Cable _____	\$99.69
17148	Branch Harness, channel 2 liquid, MT-3405 D™, 10' _____	\$267.16
17184	Channel 2 Liquid Harness, MT-3405 D™ _____	\$416.00
01725	Master Control Kit, EMD, multi-section, MT-3405 F™ II _____	\$565.00
13116	Flow, Speed, Servo, Boom Harness, MT-3400™ 5' _____	\$300.20
13088	*LR1 Run/Hold, Boom, Boost Harness, MT-3400™ 5' _____	\$310.78
13083	Flow, Run/Hold, Servo Boom Harness, MT-3405 F™ & FTW, (pigtail version), 5' _____	\$240.50
13762	Boom, Boost Relief Harness, MT-3405 F™, (pigtail version), 5' _____	\$148.83
13763	Boom, Speed Harness, MT-3405 F™, (pigtail version), 5' _____	\$168.23
17739	Multi Section Boom Master Module, 1-5 sections _____	\$342.06
17529	Multi Section Branch Harness, NH3, 1-5 sections, 2' _____	\$251.86

*Discontinued Monitors and Controllers, cont.*

14366	Main Harness, NH3, MT-3405™ F & F II & MT-9000 w/ bulkhead connection, 10'	\$392.04
13276	Main Harness, NH3, MT-3405™ F & MT-9000, (pigtail version), 10'	\$294.60
17316	Parallel Boom Harness Kit, MT-3405 D™	\$1,247.00
17420	Servo, Flow, Boom Branch Harness, MT-3407 F™ II, 10'	\$212.21
01725	Master Control Kit, EMD, multi-section, MT-3405 F™ II	\$565.00
13115	Boom Shutoff/Relief Cable, 5'	\$41.74
14318	Bulkhead Console Power Boom Harness, 10'	\$514.37
14319	Bulkhead Console Boom Branch Harness, 10'	\$282.01
14320	Bulkhead Console Flow, Servo, Run/Hold Harness, 10'	\$196.65
14793	Bulkhead Console Run/Hold Adapter Cable	\$99.69
17148	Branch Harness, channel 2 liquid, MT-3405 D™, 10'	\$267.16
17159 A	Bulkhead Console 5-boom 2-wire Ball Valve Adapter Cable	\$827.94
17184	Channel 2 Liquid Harness, MT-3405 D™	\$416.00
17316	Parallel Boom Harness Kit, MT-3405 D™	\$1,247.00
14469	Solenoid Adapter Cable, 3-Pin WPS to 1/4" QD	\$34.89
17436	Boom Branch Harness, MT-3405 F™ II, 10'	\$246.71
17529	Multi Section Branch Harness, NH3, 1-5 sections, 2'	\$251.86
17739	Multi Section Boom Master Module, 1-5 Sections	\$342.06
18413	Boom Y cable, MT-3405™ series	\$190.00

**Twin Pump™ Controller**

14582	Harness, speed/flow with run/hold, 10'	\$149.78
14583	Harness, speed/flow with Run/hold, 30'	\$260.51
14584	Boom Branch Harness, 10'	\$270.95
14585	Boom Branch Harness, 30'	\$499.88
14588	Cable, 16 Ga 5-pin MP Ext., 15'	\$231.79
14589	Cable, 12 Ga 2-conductor WP Ext, 15'	\$120.60
14600	Power/Module Cable , 5-pin MP, Whirlwind™, 20'	\$255.15
14607	Cable, local speed	\$187.46
18018	Cable, pump, 10'	\$84.77
18019	Cable, pump, 30'	\$189.75

**MT-9000™**

13115	Boom Shutoff/Relief Cable, 5'	\$41.74
17159 A	Bulkhead Console 5-boom 2-wire Ball Valve Adapter Cable	\$827.94
14319	Bulkhead Console Boom Branch Harness, 10'	\$282.01
14320	Bulkhead Console Flow, Servo, Run/Hold Harness, 10'	\$196.65
14318	Bulkhead Console Power Boom Harness, 10'	\$514.37
13083	Flow, Run/Hold, Servo Boom Harness, MT-3405 F™ & FTW, (pigtail version), 5'	\$240.50
17739	Multi Section Boom Master Module, 1-5 sections	\$342.06
17529	Multi Section Branch Harness, NH3, 1-5 sections, 2'	\$251.86
14366	Main Harness, NH3, (MT-3405 F & F II & MT-9000 with bulkhead connection), 10'	\$392.04
13256	Pressure Sensor, w/ cable, liquid and NH3, 250 PSI (17 Bar), 5'	\$789.82
13084	Pressure, Boom, Boost Harness, (Pigtail version), 5'	\$290.42
13085	Return Flow, Speed, Boom Harness, (Pigtail version), 5'	\$263.20

**Trak Record II**

17771	Power Cable	\$54.13
17787	USB Flash Drive, 128meg	\$75.72 NET
01619	Trak-Record II, (if GPS coordinates desired requires 01437 Astro™ 5)	\$871.00

**Whirlwind™**

14600	Power/Module Cable , 5-pin MP, Whirlwind™, 20'	\$255.15
14282	Boot for 1" Whirlwind™ sensor	\$24.46
14283	Boot for 1 1/4" Whirlwind™ sensor	\$26.30
14459	*Blockage Module	\$741.81
01376	*Blockage Module Kit, w/ 15' 7-pin extension	\$639.00
01380	*Shaft RPM Module Kit, w/ 15' 7-pin extension	\$569.00
14672	*Shaft Module	\$741.81
14690	Fan Module	\$727.90
14691	*Bin Level Module	\$727.89
01544	Bin Level Sensor Kit, IR type sensor	\$165.00

\*NCNR

## SPEED AND RUN/HOLD SENSOR PARTS

### Model 82A, 84C, 86S style consoles

10074	Speed and Run/Hold Sensor Cable, (82A, 84C), 16'	\$112.05
10083	Speed and Run/Hold Sensor Kit, (82A, 84C)	\$146.72
10316	Speed Sensor Cable, (86S), 9'	\$98.11
10075	Hardware Bag, (82A, 84C)	\$14.55

### MT-3000™ / MT-5000™

10416	Speed and Run/Hold Sensor Cable, MT-3000/5000, 5'	\$74.67
10514	Magnetic Speed Sensor Kit, MT-3000/5000	\$138.62
13561	Hall-effect Sensor Adapter Cable, MT-3000/5000	\$73.87

### Astro™ GPS Speed Sensor for discontinued Micro-Trak Products

01411	Astro™ II, w/ 3-pin WP, MT-3000/5000	\$529.00
01412	Astro™ II, w/ 2-pin round, M-T old style Calc-An-Acre™, Flow-Trak™, Speed-O-Meter	\$529.00
01426	Astro™ 5, w/ 3-pin, MT-3000/5000™ with MP	\$707.00
01427	Astro™ 5, w/ 2-pin round, M-T old style Calc-An-Acre™, Flow-Trak™, Speed-O-Meter	\$707.00

### Radar/ Vehicle Interface Modules

For use with 84C, FT 84C, FT 96C, 86S, MT-3000, MT-5000, Trak-Net, ST-424

12758	Radar/GM Interface Module, 3-pin WP connector for speed	\$240.82
-------	---	----------

## FLOWMETER KITS FOR OLDER FLOW-TRAK™ MODELS FT 84C AND FT 96C AND FLO-PRO™

00105	FM750 SS Flowmeter Kit, 2-40 GPM, 500 PSI, 16' cable, 2-pin Rolco	\$1011.00
00168	FM750 GFN Flowmeter Kit, 2-40 GPM, 150 PSI, 16' cable, 2-pin Rolco	\$920.00
00257	FM750 SS Flowmeter Kit, ceramic bearings, 2-40 GPM, 500 PSI, 16' cable, Rolco	\$1,011.00
00265	FM270 Flowmeter Kit, 3.5-70 GPM, 225 PSI, 16' cable, 2-pin Rolco	\$964.00
00267	FM10/100 Flowmeter Kit, 10-100 GPM, 225 PSI, 16' cable, 2-pin Rolco	\$997.00
00195	FM1500 SS Flowmeter Kit, 10-130 GPM, 500 PSI, 16' cable, 2-pin Rolco	\$1,458.00

## FLOWMETER KITS FOR MT-3000™ AND MT-5000™

00169	FM750 GFN Flowmeter Kit, 2-40 GPM, 150 PSI, 5' cable, 3-pin WP	\$533.00
00130	FM750 SS Flowmeter Kit, 2-40 GPM, 500 PSI, 5' cable, 3-pin WP	\$923.00
00258	FM750 SS Flowmeter Kit, ceramic bearings, 2-40 GPM, 500 PSI, 5' cable, 3-pin WP	\$923.00
00201	FM1000 SS Flowmeter Kit, 3.5-70 GPM, 500 PSI, 5' cable, 3-pin WP	\$1,015.00
00266	FM270 Flowmeter Kit, 3.5-70 GPM, 225 PSI, 5' cable, 3-pin WP	\$852.00
00197	FM1500 SS Flowmeter Kit, 10-130 GPM, 500 PSI, 5' cable, 3-pin WP	\$1,335.00

## FLOW SENSORS

10417	Flow Sensor Cable (MT-3000/5000), 5'	\$95.42
10132	Flow Sensor Cable (FT 84C, FT 96C), 16'	\$114.01



# INDEX

00105	FM750 SS Flowmeter Kit, 2-40 GPM, 500 PSI, 16' cable, 2-pin Rolco	\$1011.00
00130	FM750 SS Flowmeter Kit, 2-40 GPM, 500 PSI, 5' cable, 3-pin WP	\$923.00
00168	FM750 GFN Flowmeter Kit, 2-40 GPM, 150 PSI, 16' cable, 2-pin Rolco	\$920.00
00169	FM750 GFN Flowmeter Kit, 2-40 GPM, 150 PSI, 5' cable, 3-pin WP	\$533.00
00195	FM1500 SS Flowmeter Kit, 10-130 GPM, 500 PSI, 16' cable, 2-pin Rolco	\$1,458.00
00197	FM1500 SS Flowmeter Kit, 10-130 GPM, 500 PSI, 5' cable, 3-pin WP	\$1,335.00
00201	FM1000 SS Flowmeter Kit, 3.5-70 GPM, 500 PSI, 5' cable, 3-pin WP	\$1,015.00
00257	FM750 SS Flowmeter Kit, ceramic bearings, 2-40 GPM, 500 PSI, 16' cable, Rolco	\$1,011.00
00258	FM750 SS Flowmeter Kit, ceramic bearings, 2-40 GPM, 500 PSI, 5' cable, 3-pin WP	\$923.00
00265	FM270 Flowmeter Kit, 3.5-70 GPM, 225 PSI, 16' cable, 2-pin Rolco	\$964.00
00266	FM270 Flowmeter Kit, 3.5-70 GPM, 225 PSI, 5' cable, 3-pin WP	\$852.00
00267	FM10/100 Flowmeter Kit, 10-100 GPM, 225 PSI, 16' cable, 2-pin Rolco	\$997.00
01000	Calc-An-Acre™ II Kit, w/ magnetic wheel sensor	\$615.00
01001	Calc-An-Acre™ II Kit, (select speed sensor)	\$531.00
01020	Flow-Trak™ II Kit, w/ FM750 GFN flowmeter and magnetic wheel sensor	\$1,680.00
01021	Flow-Trak™ II Customized Kit, (select speed sensor and flowmeter kits)	\$917.00
01067	MC-10 Manual Controller Kit	\$325.00
01068	MC-25 Manual Controller Kit	\$619.00
01144	MT-NH3™ II Console Kit for NH3, (requires Liquifier Kit)	\$1,534.00
01170	Flow-Trak™ II Kit, w/ FM750 GFN flowmeter, (select speed sensor)	\$1,438.00
01171	SprayMate™ II Kit, w/ FM750 GFN flowmeter, 1" servo valve (select speed sensor)	\$2,010.00
01188	SprayMate™ II Starter Fertilizer Kit, w/ FM500, 40-amp EMD, (select speed sensor)	\$2,400.00
01196	SprayMate™ II Starter Fertilizer Kit, w/ FM750 LF, 40-amp EMD, (select speed sensor)	\$2,520.00
01200	ProPlant™ Single Section Mounted Harness Kit	\$197.00
01201	ProPlant™ Single Section Drawn Harness Kit, w/ 25' extension cable	\$463.00
01202	ProPlant™ Multiple Drive Mounted Harness Kit	\$287.00
01203	ProPlant™ Multiple Drive Drawn Harness Kit, w/ 25' extension cable	\$556.00
01204	ProPlant™ Console Kit	\$1,987.00
01209	^Hydraulic Drive Kit, primary, 4.9 CID, #40 3/4"	\$4,002.00
01210	^Hydraulic Drive Kit, secondary, 4.9 CID, #40 3/4"	\$4,002.00
01211	^Hydraulic Drive Kit, primary, 4.9 CID, #40 7/8"	\$4,002.00
01212	^Hydraulic Drive Kit, secondary, 4.9 CID, #40 7/8"	\$4,002.00
01224	MT-2405 F™ II Kit, w/ FM750 GFN flowmeter, 1" servo valve, magnetic wheel sensor	\$2,007.00
01226	MT-2405 F™ II Customized Kit, (use with existing section switches)	\$850.00
01323	Shaft-Trak™ Kit, w/o shaft sensor kit	\$703.00
01330	Shaft-Trak™ Kit, w/ 1 shaft sensor	\$783.00
01331	Shaft-Trak™ Kit, w/ 2 shaft sensors	\$898.00
01332	Shaft-Trak™ Kit, w/ 3 shaft sensors	\$946.00
01333	Shaft-Trak™ Kit, w/ 4 shaft sensors	\$1,023.00
01334	Shaft-Trak™ Kit, w/ 5 shaft sensors	\$1,105.00
01335	Shaft-Trak™ Kit, w/ 6 shaft sensors	\$1,181.00
01340	SprayMate™ II Kit, w/ FM750 GFN flowmeter, 1" servo valve, magnetic wheel sensor	\$2,255.00
01341	SprayMate™ II Customized Kit, 3 section	\$1,076.00
01349	SprayMate™ Plus Customized Kit, 3 section	\$1,574.00
01352	SprayMate™ Plus Kit, w/ FM750 GFN, 1" servo valve, magnetic speed sensor	\$2,751.00
01375	*Whirlwind™ Console Kit	\$1,052.00
01376	*Blockage Module Kit, w/ 15' 7-pin extension	\$639.00
01380	*Shaft RPM Module Kit, w/ 15' 7-pin extension	\$569.00
01402	GSC-1000™ Customized Kit, STD 12V	\$1,612.00
01403	GSC-1000™ Customized Kit, PWM	\$1,612.00
01404	SodPro II™ Customized Kit, (select speed sensor)	\$828.00
01410	Astro™ II GPS Speed Sensor, 3-pin MP (1 Hz)	\$529.00
01411	Astro™ II, w/ 3-pin WP, MT-3000/5000	\$529.00
01412	Astro™ II, w/ 2-pin round, M-T old style Calc-An-Acre™, Flow-Trak™, Speed-O-Meter	\$529.00
01413	Astro™ II, w/ 4-pin Dickey JOHN®/AMP	\$529.00

\*NCNR

^One year warranty

## INDEX BY PART NUMBER

01414	Astro™ II, w/ 4-pin Dickey JOHN®/Packard _____	\$529.00
01415	Astro™ II, w/ 3-pin Raven/Conxall _____	\$529.00
01416	Astro™ II, w/ 4-pin Magnavox, Phillips/Packard _____	\$529.00
01417	Astro™ II, w/ 3-pin Spraying Systems #844/Deutsch _____	\$529.00
01419	Astro™ II, w/ 3-pin Spraying Systems #855/Deutsch (round shell) _____	\$529.00
01420	Astro™ II, w/ 3-pin Hiniker/Cannon _____	\$579.00
01425	Astro™ 5 GPS Speed Sensor, 3-pin MP (5 Hz) _____	\$707.00
01426	Astro™ 5, w/ 3-pin, MT-3000/5000™ with MP _____	\$707.00
01427	Astro™ 5, w/ 2-pin round, M-T old style Calc-An-Acre™, Flow-Trak™, Speed-O-Meter _____	\$707.00
01428	Astro™ 5, w/ 4-pin Dickey JOHN®/AMP _____	\$707.00
01429	Astro™ 5, w/ 4-pin Dickey JOHN®/Packard _____	\$707.00
01430	Astro™ 5, w/ 3-pin Raven/Conxall _____	\$707.00
01431	Astro™ 5, w/ 4-pin Magnavox, Phillips/Packard _____	\$707.00
01432	Astro™ 5, w/ 3-pin Spraying Systems #844/Deutsch _____	\$707.00
01433	Astro™ 5, w/ 3-pin Spraying Systems #855/Deutsch (round shell) _____	\$707.00
01435	Astro™ 5, w/ 3-pin Hiniker/Cannon _____	\$754.00
01437	Astro™ 5 GPS Speed Sensor, 3-pin MP for Trak-Record II _____	\$754.00
01462	Speed/Flow Simulator _____	\$200.00 NET
01463	Shaft-Trak™ Low RPM Kit, w/o sensor kit _____	\$703.00
01464	Shaft-Trak™ Low RPM Kit, w/ 1 sensor kit _____	\$783.00
01465	Shaft-Trak™ Low RPM Kit, w/ 2 sensor kits _____	\$898.00
01466	Shaft-Trak™ Low RPM Kit, w/ 3 sensor kits _____	\$946.00
01467	Shaft-Trak™ Low RPM Kit, w/ 4 sensor kits _____	\$1,023.00
01468	Shaft-Trak™ Low RPM Kit, w/ 5 sensor kits _____	\$1,105.00
01469	Shaft-Trak™ Low RPM Kit, w/ 6 sensor kits _____	\$1,181.00
01478	*Demonstration Display, SafeGuard™ _____	\$1,859.31 NET
01479	*Demonstration Display, RoadMaster™ _____	\$975.81 NET
01483	*Demonstration Display, Shaft-Trak™ _____	\$460.58 NET
01484	*Demonstration Display, GSC-1000™ _____	\$850.90 NET
01485	*Demonstration Display, MT-NH3™ II _____	\$858.70 NET
01488	*Demonstration Display, SprayMate™ II _____	\$866.51 NET
01489	*Demonstration Display, Calc-An-Acre™ II & Flow-Trak™ II _____	\$897.74 NET
01490	*Demonstration Display w/o console or adapter _____	\$616.71 NET
01495	*Demonstration Display, RateKing™ Plus _____	\$1,195.02 NET
01497	*Demonstration Display, RateKing™ Dual Plus _____	\$1,629.60 NET
01500	FM500 Flowmeter Kit, .5-5 GPM, 500 PSI, 1/2" FPT, PP & Hastelloy _____	\$520.00
01501	FM750 GFN Flowmeter Kit, 2-40 GPM, 150 PSI, 3/4" FPT, nylon & Hastelloy _____	\$520.00
01504	FM750 SS Flowmeter Kit, 2-40 GPM, 500 PSI, 3/4" FPT, SS & nylon & Hastelloy _____	\$936.00
01505	FM1000 SS Flowmeter Kit, 3.5-70 GPM, 500 PSI, 1" FPT, SS & nylon & Hastelloy _____	\$1,015.00
01506-P A	FM1500 P SS Flowmeter Kit, 10-130 GPM, 500 PSI, 1 1/2" FPT, PP & nylon & Hastelloy _____	\$1,007.00
01506	FM1500 SS Flowmeter Kit, 10-130 GPM, 500 PSI, 1 1/2" FPT, SS & nylon & Hastelloy _____	\$1,335.00
01507	FM750 SS Flowmeter Kit, w/ ceramic bearings, 2-40 GPM, 500 PSI, 3/4" FPT _____	\$936.00
01511	^FM2000 P Flowmeter Kit, 19-198 GPM, 285 PSI, M200 flange, nylon & SS & ceramic _____	\$1,539.00
01513	^FM3000 P Flowmeter Kit, 40-396 GPM, 285 PSI, 3" MPT, nylon & SS & ceramic _____	\$2,013.00
01514-P A	FM10/100 P Flowmeter Kit, 10-100 GPM, 225 PSI, M200 flange, PP & nylon & Hastelloy _____	\$588.00
01514	FM10/100 Flowmeter Kit, 10-100 GPM, 225 PSI, M200 flange, SS, PP & nylon & Hastelloy _____	\$884.00
01515-P A	FM270 P Flowmeter Kit, 3.5-70 GPM, 225 PSI, M200 flange, PP & nylon & Hastelloy _____	\$567.00
01515	FM270 Flowmeter Kit, 3.5-70 GPM, 225 PSI, M200 flange, PP, SS, nylon & Hastelloy _____	\$852.00
01519-P A	FM1500 P SS LF Flowmeter Kit, 3.5-70 GPM, 500 PSI, 1 1/2" FPT, PP & nylon & Hastelloy _____	\$1,047.00
01519	FM1500 SS LF Flowmeter Kit, 3.5-70 GPM, 500 PSI, 1 1/2" FPT, SS & nylon & Hastelloy _____	\$1,391.00
01526	^Vansco® Radar Speed Sensor with Gen. II adapter Cable _____	\$1,262.03
01527	^Vansco® Radar Speed Sensor with Gen. I adapter cable _____	\$1,262.03
01528	^Vansco Radar Speed Sensor with 4-pin AMP connector _____	\$1,233.03
01530	Wheel Speed Sensor Kit, Hall-effect Magnetic, w/ 10' extension cable, mounting bracket, 6 magnets _____	\$249.00
01531	Wheel Speed Sensor Kit, Hall-effect Magnetic, w/ 15' extension cable, mounting bracket, 6 magnets _____	\$270.00

\*NCNR

^One year warranty



## INDEX BY PART NUMBER

01533	Wheel Speed Sensor Kit, Hall-effect Magnetic, w/ mounting bracket, 6 magnets _____	\$136.00
01535	Run/Hold Sensor Kit, Hall-effect, w/ 2 magnets, 10' extension cable _____	\$211.24
01536	*Relay Kit, Flow-Trak™ 97 LR _____	\$125.75
01539	RPM Sensor Kit, RPM sensor, w/ mounting bracket, 2 magnets _____	\$141.93
01544	Bin Level Sensor Kit, IR type sensor _____	\$165.00
01554	RPM Sensor Kit, proximity or gear tooth sensor, w/ 15' extension cable, mounting bracket _____	\$389.00
01577-P A	FM270 Flowmeter Kit, 3.5-70 GPM, 225 PSI, M200 flange, PP & nylon & Hastelloy _____	\$645.00
01577	FM270 Flowmeter Kit, 3.5-70 GPM, 225 PSI, M200 flange, PP, SS & nylon & Hastelloy _____	\$919.84
01578-P A	FM10/100 Kit, 10-100 GPM, 225 PSI, M200 flange, PP & nylon & Hastelloy _____	\$667.00
01578 A	FM10/100 Kit, 10-100 GPM, 225 PSI, M200 flange, PP, SS & nylon & Hastelloy _____	\$919.84
01586	DirectConnect™ Harness Kit for AgLeader® DirectCommand®, 1 section, NH3 _____	\$774.00
01587	DirectConnect™ Harness Kit for AgLeader® DirectCommand®, 5 sections, NH3 _____	\$1,538.00
01590	RoadMaster™ Customized Kit, STD 12V _____	\$2,063.00
01591	RoadMaster™ Customized Kit, PWM control _____	\$2,063.00
01592	^Servo Valve Signal Chopper, (REQUIRED with Micro-Trak servo valve) _____	\$259.00
01596	DirectConnect™ Harness Kit for Raven 440/450, 1 section, NH3 _____	\$748.00
01597	DirectConnect™ Harness Kit for Raven 440/450, 5 section, NH3 _____	\$1,029.00
01619	Trak-Record II, (if GPS coordinates desired requires 01437 Astro™ 5) _____	\$871.00
01650	FM750 GFN LF Flowmeter Kit, .5-12 GPM, 150 PSI, 3/4" FPT, nylon & Hastelloy _____	\$641.00
01651	DirectConnect™ Harness Kit for AgLeader® DirectCommand®, liquid _____	\$506.00
01680	DrillMaster™ Mounted Harness Kit, 1 section, w/ 15' extension cable _____	\$195.00
01682	DrillMaster™ Console Kit _____	\$1,444.00
01684	DrillMaster™ Drawn Kit, 3 section, w/ 40' extension cable _____	\$1,206.00
01685	^Hydraulic Drive Kit, primary, 4.9 CID, #40 DM _____	\$2,837.00
01687	FM750 GFN Flowmeter Kit, w/ reed flow sensor, 2-40 GPM, 150 PSI, 3/4" FPT, nylon & Hastelloy _____	\$468.00
01691	DrillMaster™ Drawn Kit, 2 section, w/ 40' extension cable _____	\$1,082.00
01707	^Hydraulic Drive Kit, secondary, 4.9 CID, #40 DM _____	\$2,837.00
01725	Master Control Kit, EMD, multi-section, MT-3405 F™ II _____	\$565.00
01739	FlowMate™ Customized Kit, (select flowmeter kit) _____	\$524.00
01740	FlowMate™ Kit, w/ FM750 GFN LF _____	\$1,164.00
01741	FlowMate™ Kit, w/ FM750 GFN _____	\$1,041.00
01744	RoadMaster™ Blast/Run/Hold Remote Switch Box, w/ 3-pin MP connector (current) _____	\$246.00
01745	^PWM Hydraulic Flow Control Valve w/ Adapter Cable, 8 GPM, SAE 8 ports, 3000 PSI _____	\$769.00
01749	MM238 Flowmeter Kit, 12 to 238 GPM, 290 PSI, 2" MPT, PP & SS _____	\$1,439.00
01756	Flow Sensor Kit for Honeywell flow sensor _____	\$551.42
01757	Electric Motor Driver Kit, STD, 40 Amp _____	\$851.00
01758	Electric Motor Driver Kit, PWM, 40 Amp  _____	\$851.00
01772	Liquifier Cooler Retro Kit _____	\$3,251.00
01775	Liquifier Max Cooler Retro Kit _____	\$8,296.00
01781	Parallel Boom "Y" Cable Kit, RateKing™ Dual, 5 section _____	\$484.81
01815	Liquifier Junior Ultra-Low Rate NH3 Kit, 600-2800 lbs. (272-1270 kg) NH3/hour _____	\$5,067.00
01816	Liquifier Junior NH3 Kit, 1000-6000 lbs. (453-2722 kg) NH3/hour _____	\$5,067.00
01817	Liquifier NH3 Kit, 1500-12000 lbs. (680-5443 kg) NH3/hour _____	\$6,760.00
01818	Liquifier Max Kit, 3100-21000 lbs. (1406-9525 kg) NH3/hour _____	\$15,004.00
01821	^MM3 Flowmeter Kit, .13 to 2.6 GPM, 290 PSI, 3/4" FPT, PP & SS _____	\$2,148.00
01822	^MM5 Flowmeter Kit, .3 to 5 GPM, 290 PSI, 3/4" FPT, PP & SS _____	\$2,148.00
01823	^MM13 Flowmeter Kit, .6 to 13 GPM, 290 PSI, 3/4" FPT, PP & SS _____	\$2,148.00
01824	^MM26 Flowmeter Kit, 1.3 to 26 GPM 290 PSI, 1" FPT, PP & SS _____	\$2,148.00
01825	^MM53 Flowmeter Kit, 2.6 to 53 GPM, 290 PSI, 1" FPT, PP & SS _____	\$2,148.00
01826	^MM106 Flowmeter Kit, 5 to 106 GPM, 290 PSI, 1 1/2" FPT, PP & SS _____	\$2,148.00
01827	^MM158 Flowmeter Kit, 8 to 158 GPM, 290 PSI, 2" MPT, PP & SS _____	\$2,148.00
01828	DirectConnect™ Harness Kit for GreenStar™ Rate Controller, liquid/NH3, 1 section, 37-pin AMP CPC _____	\$743.00
01829	DirectConnect™ Harness Kit for GreenStar™ Rate Controller, liquid/NH3, 1-6 sections _____	\$1,010.00
01830	DirectConnect™ Harness Kit for GreenStar™ Rate Controller, liquid/NH3, 1-10 sections _____	\$1,241.00
01841	*Demonstration Display, SprayMate™ Plus _____	\$1,073.46 NET

\*NCNR

^One year warranty

## INDEX BY PART NUMBER

01845	Dual ISOmod™ Kit, single product rate control, w/ power cable & channel 1 harness _____	\$2,373.00
01847	Astro™ II, w/ 3-pin Amp Superseal (HARDI) _____	\$529.00
01848	Astro™ 5, w/ 3-pin Amp Superseal, (HARDI) _____	\$707.00
01851	FM750 LF SS Flowmeter Kit, 1-9 GPM, 500 PSI, 3/4" FPT, SS & nylon & Hastelloy _____	\$1,059.00
01864	^PWM Hydraulic Flow Control Valve w/ Adapter Cable, 15 GPM, SAE 10 ports, 3000 PSI _____	\$1,133.00
01866	SprayMate™ Plus Kit, w/ FM 750 GFN, 1" servo valve, (select speed sensor) _____	\$2,514.00
01878	RateKing™ Plus Customized Kit, 3 section _____	\$1,883.00
01881	RateKing™ Plus Customized Kit, 5 section _____	\$1,883.00
01882	RateKing™ Plus Kit, 5 Section, w/ FM750 GFN, 1" servo valve, magnetic wheel sensor _____	\$3,063.00
01883	RateKing™ Plus Kit, 5 Section, w/ FM750 GFN, 1" servo valve, (select speed sensor) _____	\$2,818.00
01893	RateKing™ Plus Customized Kit, 7 section _____	\$2,231.00
01894	RateKing™ Plus Kit, 7 Section, w/ FM750 GFN, 1" servo valve, (select speed sensor) _____	\$3,170.00
01895	RateKing™ Plus Kit, 7 Section, w/ FM750 GFN, 1" servo valve, magnetic wheel sensor _____	\$3,412.00
01898-P A	FM270 P LF Flowmeter Kit, .5-15 GPM, 225 PSI, M200 flange, PP & nylon & Hastelloy _____	\$609.00
01898	FM270 LF Flowmeter Kit, .5-15 GPM, 225 PSI, M200 flange, PP, SS, & nylon & Hastelloy _____	\$914.00
01899	RateKing™ Dual Plus Customized Kit, 5 section, w/ channel 1 & channel 2 harnesses _____	\$3,213.00
01901	^MM2 Flowmeter Kit, .08 to 1.6 GPM, 290 PSI, 3/4" FPT, PP & SS _____	\$2,148.00
01903	*Demonstration Display, SafeGuard™ Upgrade to ISOmod™ _____	\$362.00 NET
01904	Electric Motor Driver Kit, PWM, w/ enable, 10 Amp _____	\$569.00
01905	Electric Motor Driver Kit, PWM, w/ enable, 40 Amp _____	\$851.00
01909	RateKing™ Dual Plus Customized Kit, 3 section, w/ channel 1 & channel 2 harnesses _____	\$3,213.00
01910	RateKing™ Dual Plus Customized Kit, 7 section, w/ channel 1 & channel 2 harnesses _____	\$3,697.00
01972	SprayMate™ II Kit, w/ FM750 GFN flowmeter, 1" servo valve, Astro™ II GPS Speed Sensor _____	\$2,523.00
01973	SprayMate™ II Starter Fertilizer Kit, w/ FM500, 40-amp EMD, Astro™ II GPS Speed Sensor _____	\$2,913.00
01974	SprayMate™ II Starter Fertilizer Kit, w/ FM750LF, 40-amp EMD, Astro™ II GPS Speed Sensor _____	\$3,031.00
01975	SprayMate™ Plus Kit, w/ FM 750 GFN flowmeter, 1" servo valve, Astro™ II GPS Speed Sensor _____	\$3,029.00
01976	RateKing™ Plus Kit, 5 Section, w/ FM750 GFN, 1" servo valve, Astro™ II GPS Speed Sensor _____	\$3,329.00
01977	RateKing™ Plus Kit, 7 Section, w/ FM750 GFN, 1" servo valve, Astro™ II GPS Speed Sensor _____	\$3,683.00
01980-P A	FM270 LF Flowmeter Kit, .5-15 GPM, 225 PSI, M200 flange, PP & nylon & Hastelloy _____	\$693.00
01980	FM270 LF Flowmeter Kit, .5-15 GPM, 225 PSI, M200 flange, PP, SS & nylon & Hastelloy _____	\$989.00
01984	FM250 P Flowmeter Kit, .08-1.6 GPM, 290 PSI, 1/4" NPT and 1/2" HB, IXEF & SS _____	\$661.00
01993	Dual ISOmod™ Kit, dual product rate control, w/ power cable & channel 1 & channel 2 harnesses _____	\$2,620.00
01994	Liquid Blockage Sensor, SafeGuard™, Amphenol, PVC, short leads _____	\$181.00
01995	Liquid Blockage Sensor, SafeGuard™, Amphenol, PVC, long leads _____	\$207.00
01997	Fumigant Blockage Sensor, SafeGuard™, Amphenol, Trogamid, long leads _____	\$241.00
01998	Run/Hold Sensor Kit, whisker switch, magnetic mount, includes 18541 and 19625A _____	\$475.00
01999	SafeGuard™ Console Kit, Amphenol conn. _____	\$1,215.00
02000	SafeGuard™ ISOmod™ Kit, Amphenol conn. _____	\$1,405.00
02002	*Demonstration Display, SafeGuard™ Retrofit Kit (Update to Amphenol plugs) _____	\$378.00 NET
02003	*Demonstration Display, SafeGuard™ Retrofit Kit w/ISOmod™ (Amphenol plugs) _____	\$659.00 NET
02011	Magnet Bar Mount, ISOmod™ _____	\$46.84
02015	^MM106FL Flowmeter Kit, 5 to 106 GPM, 290 PSI, M220 flange, PP & SS _____	\$2,148.00
02016	Flo-Pro™ Customized Kit, includes 10' branch harness, 10' power cable _____	\$1,240.00
02021	RateKing™ XRS Customized Kit, 4 section _____	\$2,748.00
02026 A	SprayMate™ Plus Kit, w/Raven 440 adapter cable, CPC female connector _____	\$1,422.10
02027	SprayMate™ XRS Customized Kit, 2 section _____	\$1,934.80
02028	FM1500 SS Flowmeter Kit, NH3, 10-130 GPM, 500 PSI, 1 1/2" FPT, SS & nylon & Hastelloy _____	\$1,355.00
02029	FM1500 SS LF Flowmeter Kit, NH3, 3.5-70 GPM, 500 PSI, 1 1/2" FPT, SS & nylon & Hastelloy _____	\$1,418.00
02034	Dual ISOmod™ Kit, single product rate control, w/ channel 1 harness, w/o power cable _____	\$2,126.00
02035	Dual ISOmod™ Kit, dual product rate control, w/ channel 1 & channel 2 harnesses, w/o power cable _____	\$2,370.00
02038 A	SprayMate™ Plus Kit, w/Raven 440 adapter cable, CPC male (old style) connector _____	\$1,422.10
02054 A	SprayMate™ Plus Fertilizer Kit, w/ FM750 GFN LF, 40-amp PWM EMD, Astro II GPS Speed Sensor _____	\$3,582.00
02059 A	Dual ISOmod™ Kit, w/ Raven adapter cable, w/ power cable _____	\$2,620.00
02060 A	Dual ISOmod™ Kit, w/ Raven adapter cable, w/o power cable _____	\$2,370.00
02066 A	PWM Hydraulic Flow Control Valve w/ Adapter Cable, 25 GPM, SAE 16 ports, 3000 PSI _____	\$1,714.41

\*NCNR

^One year warranty

## INDEX BY PART NUMBER

02079 A	PWM Hydraulic Flow Control Valve w/ Adapter Cable, 48 GPM, SAE 20 ports, 3000 PSI _____	\$1,513.00
02086 A	^MM528 Flowmeter Kit, 26.5 to 528 GPM, 145 PSI, 3" MPT, 3-pin MP-150 Connector, PP & SS _	\$1,631.00
10013	Mount Bracket for speed and run/hold sensor _____	\$16.97
10049	Console Mount Bracket, 82A - 84C size consoles _____	\$13.92
10050	Console Mount Washer, 82A, 84C size consoles _____	\$3.15
10051	Console Mount Knob, 82A - 84C size consoles _____	\$6.09
10073	Power Cable (82A), 8' _____	\$57.53
10074	Speed and Run/Hold Sensor Cable, (82A, 84C), 16' _____	\$112.05
10075	Hardware Bag, (82A, 84C) _____	\$14.55
10080	Magnet Clip _____	\$11.19
10083	Speed and Run/Hold Sensor Kit, (82A, 84C) _____	\$146.72
10085	Extension Cable for speed and run/hold (82A, 84C), 20' _____	\$96.41
10131	FM750 SS Flowmeter, 2-40 GPM, 500 PSI, 3/4" FPT, SS & nylon & Hastelloy _____	\$910.00
10132	Flow Sensor Cable (FT 84C, FT 96C), 16' _____	\$114.01
10137	Gasket, teflon, FM750 SS & N and FM1000 SS _____	\$8.53
10154	System Manual, Calc-An-Acre™ 84C _____	\$15.23 NET
10195	Extension Cable for flow sensor (FT 84C, FT 96C), 20' _____	\$96.39
10233	Steel Vapor Tube, 1/2" x 1' _____	\$64.75
10262	Round Connector Replacement Kit, 2-pin, w/ both halves and pins _____	\$25.17
10316	Speed Sensor Cable, (86S), 9' _____	\$98.11
10415	MT-3000™ Main Wiring Harness, liquid, 12' _____	\$504.30
10416	Speed and Run/Hold Sensor Cable, MT-3000/5000, 5' _____	\$74.67
10417	Flow Sensor Cable (MT-3000/5000), 5' _____	\$95.42
10419 A	Solenoid Cable (MT-3000), 3' _____	\$48.69
10423	Console Mount Knob, RateKing™ or aluminum consoles measuring 8 - 11/16" _____	\$10.50
10445	Shroud Dust Cover, 3-pin WP, female _____	\$16.29
10447	Tower Dust Cover, 3-pin WP, male _____	\$16.29
10449	Extension Cable, 3-pin WP, 10' _____	\$85.79
10450	Extension Cable, 3-pin WP, 5' _____	\$76.53
10451	Shroud Dust Cover, w/ jumper wire, 3-pin WP, female _____	\$18.04
10470	Console Mount Washer, RateKing™ or aluminum consoles measuring 8 - 11/16" _____	\$5.71
10474	Compression Fitting Kit _____	\$46.72
10485	Pressure Tubing Extension Kit, 15' _____	\$61.65
10514	Magnetic Speed Sensor Kit, MT-3000/5000 _____	\$138.62
10523	Connector Replacement Kit, 3-pin WP, w/ both halves, pins and seals _____	\$37.72
10605	O-Ring, FM500 _____	\$5.79
10829	Extension Cable, 3-pin WP, 20' _____	\$108.24
10876	Extension Cable, 3-pin WP, 15' _____	\$97.81
10899	FM750 SS for NH3 Flowmeter, 2-40 GPM, 500 PSI, 3/4" FPT, SS & nylon Hastelloy _____	\$1,108.95
11008	Vapor Tubing Elbow, 3/8" FPT x 3/8" _____	\$29.75
11009	Vapor Tubing Elbow, 3/4" MPT x 3/8" _____	\$30.67
11022	Nipple, 1/8" x 1 1/2", SS _____	\$25.78
11023	Bushing, 1/4" x 1/8", SS _____	\$20.05
11024	Vapor Tubing, 3/4" EVA, 25' _____	\$305.19
11025	Vapor Tubing, 1/2" EVA, 25' _____	\$222.22
11034	Tower Dust Cover, 6-pin WP, male _____	\$22.00
11035	Shroud Dust Cover, 6-pin WP, female _____	\$22.22
11037	Plumbing Panel Harness (MT-3000, MT-5000, TN-7000), 3' _____	\$129.15
11039	NH3 Main Harness (MT-3000) _____	\$416.29
11040	Accessory Kit, NH3500 _____	\$188.87
11050	Extension Cable, 6-pin WP, 5' _____	\$138.62
11051	Extension Cable, 6-pin WP, 10' _____	\$171.86
11052	Extension Cable, 6-pin WP, 20' _____	\$241.05
11154	Connector Replacement Kit, 6-pin WP, w/ both halves, pins and seals _____	\$67.00
11191	Strainer Screen, NH3, #20, SS _____	\$53.43

\*NCNR

^One year warranty

## INDEX BY PART NUMBER

11192	Strainer Gasket, NH3, Teflon _____	\$10.96
11203	Snubber Washer Kit, w/o-ring _____	\$21.40
11259-01	^Polmac FM2000P & 3" Sensor, green _____	\$372.49
11259-02	^Polmac Seeger Ring #48, 2" _____	\$20.09
11259-03	^Polmac Tunnel, 2" _____	\$69.00
11259-04	^Polmac Shaft Holder, 2" _____	\$16.09
11259-05	^Polmac Turbine Shaft, 2" _____	\$17.41
11259-06	^Polmac Seeger Ring #10, 2" _____	\$17.41
11259-07	^Polmac Flowmeter Rotor Bearing, 2" _____	\$88.41
11259-08	^Polmac Flowmeter Spacer Washer, 2" _____	\$18.75
11259-09	^Polmac SS Turbine, 2" _____	\$494.30
11259-10	^Polmac Flowmeter Housing, 2" _____	\$390.68
11259-11	^Polmac Rotor Shaft, ceramic _____	\$88.41
11259-12	^Polmac Rotor Bushing, ceramic _____	\$31.60
11259-13	^Polmac Rotor Support, ceramic _____	\$178.16
11259-14	^Polmac Rotor Support, nylon _____	\$14.74
11259-15	^Polmac Flow Sensor, sq. wave, yellow _____	\$278.69
11277	Bearing Assembly Rebuild Kit w/ ruby balls for FM750 SS, FM1000 SS and FM1500 SS, w/o turbine _	\$100.49
11305	Hold/Cutout Module, MT-3000™, MT-5000™ _____	\$208.48
11311	M-T Servo Valve Cable, w/ boost wire, 5' _____	\$81.39
11400	Tower Dust Cover, 2-pin WP, male _____	\$13.41
11401	Shroud Dust Cover, 2-pin WP, female _____	\$13.41
11461	Radar Module Adapter Cable, (84C, FT 84C, FT 96C, 86S, YT 85) _____	\$46.19
11462	Extension Cable, 3-pin WP, 25' _____	\$118.46
11501	FM750 GFN Flowmeter, 2-40 GPM, 150 PSI, 3/4" FPT, nylon & Hastelloy _____	\$494.00
11527	Y-Cable for Dickey JOHN®/AMP radar, 1' _____	\$370.63
11528	Power Cable for Dickey JOHN®/AMP radar, 6' _____	\$140.74
11529	Y-Cable for Magnavox, Phillips radars, 1' _____	\$172.43
11530	Power Cable for Magnavox, Phillips radars, 6' _____	\$137.41
11560	Extension Cable, 2-pin WP, 5' _____	\$58.67
11561	Extension Cable, 2-pin WP, 10' _____	\$68.15
11671	Extension Cable, 2-pin WP, 15' _____	\$74.14
11672	Extension Cable, 2-pin WP, 20' _____	\$75.72
11693	Y-Cable for Dickey JOHN®/Packard radar, 1' _____	\$239.80
11829	Connector Replacement Kit, 2-pin WP, w/ both halves, pins and seals _____	\$32.62
11837	Dual Lock Fastener Kit, (4 sets of 1" X 1") _____	\$22.62 NET
12069	Magnet Kit, 6 magnets _____	\$18.33
12095	Y-Cable for Raven radar, 1' _____	\$269.31
12245	System Manual, MT-3000™ _____	\$15.23 NET
12274-P A	FM1500 P SS Flowmeter, 10-130 GPM (40-500 lpm) 500 PSI (35 Bar) _____	\$981.00
12274 C	FM1500 SS Flowmeter, 10-130 GPM, 500 PSI, 1 1/2" FPT, SS & nylon & Hastelloy _____	\$1,308.00
12414-01	^Polmac Rotor Repair Kit, ceramic, 3" _____	\$495.69
12414-02	^Polmac Flow Sensor, sinusoidal, 3", green _____	\$396.47
12414-03	^Polmac Flowmeter Turbine, 3" _____	\$1,198.91
12414-04	Flowmeter Rotor Shaft, ceramic, 3' _____	\$88.41
12689	*Y-Cable for Dickey JOHN®/Ford radar, 1' _____	\$211.17
12690	*Power Cable for Dickey JOHN®/Ford radar, 6' _____	\$138.73
12758	Radar/GM Interface Module, 3-pin WP connector for speed _____	\$240.82
12798	*Y-Cable for Dickey JOHN®/Deutsch radar, 1' _____	\$298.05
12800	Power Cable for Dickey JOHN®/Deutsch radar, 6' _____	\$137.38
12813	System Manual, Flow-Trak™ FT84C, FT96C _____	\$15.23 NET
12817	USIM Wire Assembly, 2-pin, 5' _____	\$23.51
12828	Plug, 1/8", (Low Rate Kit) _____	\$27.00
12853	Weatherproof Fuse Holder w/o fuse _____	\$28.80
12888	Console Mount Knob, any black plastic consoles _____	\$7.17

\*NCNR

^One year warranty

## INDEX BY PART NUMBER

12889	Console Mount Washer, any black plastic consoles _____	\$2.96
12910	Plastic Tie Kit, 14", (bag of 10) _____	\$12.78
12911	Hex Nut for Speed and Run/Hold Sensor, 3/8", (bag of 3) _____	\$7.37
12912	Magnet Kit, w/ tape (6 magnets) _____	\$28.54
12953	Adapter Cable for in-cab John Deere® 8000 & 9000 Series, 1.5' _____	\$79.96
13083	Flow, Run/Hold, Servo Boom Harness, MT-3405 F™ & FTW, (pigtail version), 5' _____	\$240.50
13084	Pressure, Boom, Boost Harness, (Pigtail version), 5' _____	\$290.42
13085	Return Flow, Speed, Boom Harness, (Pigtail version), 5' _____	\$263.20
13088	*LR1 Run/Hold, Boom, Boost Harness, MT-3400™ 5' _____	\$310.78
13090	Power Harness, speed, run/hold (C-97-LR) _____	\$185.66
13096	Speed/Flow Sensor, Hall-effect w/ MP shroud, 5' _____	\$132.96
13097	Power Harness, flow, speed, run/hold, Flow-Trak™ 97 LR _____	\$250.14
13100	Shroud Dust Cover, w/ jumper wire, 3-pin MP, female _____	\$16.45
13104	Tower Dust Cover, 2-pin MP, male _____	\$11.00
13105	Shroud Dust Cover, 2-pin MP, female _____	\$11.00
13106	Tower Dust Cover, 3-pin MP, male _____	\$16.45
13107	Shroud Dust Cover, 3-pin MP, female _____	\$16.45
13110	Tower Dust Cover, 6-pin MP, male _____	\$24.42
13111	Shroud Dust Cover, 6-pin MP, female _____	\$24.42
13112	Tower Dust Cover, 10-pin MP, male _____	\$25.25
13113	Shroud Dust Cover, 10-pin MP, female _____	\$25.25
13115	Boom Shutoff/Relief Cable, 5' _____	\$41.74
13116	Flow, Speed, Servo, Boom Harness, MT-3400™ 5' _____	\$300.20
13181	Console Mount Kit, any black plastic consoles _____	\$34.97
13184	System Manual, Calc-An-Acre™ LR _____	\$15.23 NET
13187	FM1000 SS Flowmeter, 3.5-70 GPM, 500 PSI, 1" FPT, SS & nylon & Hastelloy _____	\$988.00
13200	Extension Cable, 2-pin MP 150, 5' _____	\$74.21
13201	Extension Cable, 2-pin MP 150, 10' _____	\$80.11
13202	Extension Cable, 2-pin MP 150, 15' _____	\$86.60
13203	Extension Cable, 2-pin MP 150, 20' _____	\$90.39
13204	Extension Cable, 2-pin MP 150, 25' _____	\$97.80
13205	Extension Cable, 3-pin MP 150, 5' _____	\$82.01
13206	Extension Cable, 3-pin MP 150, 10' _____	\$87.55
13207	Extension Cable, 3-pin MP 150, 15' _____	\$98.43
13208	Extension Cable, 3-pin MP 150, 20' _____	\$104.69
13209	Extension Cable, 3-pin MP 150, 25' _____	\$111.73
13220	Extension Cable, 10-pin MP 150, 5' _____	\$142.53
13221	Extension Cable, 10-pin MP 150, 10' _____	\$170.20
13222	Extension Cable, 10-pin MP 150, 15' _____	\$194.62
13223	Extension Cable, 10-pin MP150, 20' _____	\$233.12
13224	Extension Cable, 10-pin MP 150, 25' _____	\$274.69
13226	Run/Hold Sensor Cable, 5' _____	\$95.76
13231	Connector Replacement Kit, 2-pin MP, w/ both halves, pins and seals _____	\$41.62
13232	Connector Replacement Kit, 3-pin MP 150, w/ both halves, pins and seals _____	\$46.79
13233	Connector Replacement Kit, 4-pin MP, w/ both halves, pins and seals _____	\$50.55
13234	Connector Replacement Kit, 6-pin MP, w/ both halves, pins, seals _____	\$47.60
13235	Connector Replacement Kit, 10-pin MP, w/ both halves, pins and seals _____	\$75.68
13251	Hardware Bag _____	\$13.54
13254	Console Mount Kit, MT-9000™ series _____	\$66.75
13255	System Manual, MT-9000™ _____	\$15.23 NET
13256	Pressure Sensor, w/ cable, liquid and NH3, 250 PSI (17 Bar), 5' _____	\$789.82
13269	FM500 Flowmeter, .5-5 GPM, 500 PSI, 1/2" FPT, PP & Hastelloy _____	\$494.00
13270	Terminal Kit, w/ weatherproof fuse holder _____	\$94.21
13273	Plumbing Panel Harness, NH3, (current controllers), 7' _____	\$504.23
13276	Main Harness, NH3, MT-3405™ F & MT-9000, (pigtail version), 10' _____	\$294.60

\*NCNR

^One year warranty

## INDEX BY PART NUMBER

13348	Pin, Quick Release Switchbox, SS _____	\$36.66
13369	Connector Replacement Kit, 15-pin, MT-3000, (harness half ONLY, pins and strain relief) _____	\$47.67
13419	Extension Cable, 3-pin MP 150, 50' _____	\$158.70
13434	^VRS Interface Module _____	\$271.46
13504	Adapter Cable, in-line M-T servo valve, 1' _____	\$101.72
13521	Crimping Tool, WP _____	\$220.85 NET
13522	Crimping Tool Kit, MP _____	\$288.85 NET
13523	Terminal Removal Tool, WP _____	\$18.74 NET
13524	Terminal Removal Tool, MP _____	\$18.74 NET
13561	Hall-effect Sensor Adapter Cable, MT-3000/5000 _____	\$73.87
13604	System Manual, MT-NH3™ _____	\$15.23 NET
13620	Power Cable, 2-pin MP, MT-NH3™, 10' _____	\$54.37
13629 B	Console Mount Bracket, RateKing™ or aluminum consoles measuring 8 - 11/16" _____	\$24.11
13752	FM750 SS Flowmeter, w/ ceramic bearings, 2-40 GPM, 500 PSI, 3/4" FPT _____	\$910.00
13753	Bearing Assembly Rebuild Kit w/ ceramic balls for FM750 SS, FM1000 SS and FM1500 SS, w/o turbine_	\$104.08
13757	Branch Harness, speed, run/hold, MT-2405 F™ II and FTW II, 10' _____	\$231.96
13758	Branch Harness, boom, power, servo, MT-2405 F™ II and FTW II, 10' _____	\$199.11
13759	Connector Replacement Kit, 3-pin MP 630, w/ both halves, pins and seals _____	\$57.23
13762	Boom, Boost Relief Harness, MT-3405 F™, (pigtail version), 5' _____	\$148.83
13763	Boom, Speed Harness, MT-3405 F™, (pigtail version). 5' _____	\$168.23
13773	System Manual, MT-3405 F™ _____	\$15.23 NET
13774	Console Mount Kit, RateKing™ or aluminum consoles measuring 8 - 11/16" _____	\$75.73
13783	O-Ring, quad for FM750 GFN _____	\$27.98
13797	System Manual, MT-9000™, (NH3 Specific) _____	\$15.23 NET
13857	^Servo Type Hydraulic Flow Control Valve, 15 GPM, 3.5 Second, SAE 8 ports, 3000 PSI _____	\$1,654.00
13858	^Servo Type Hydraulic Flow Control Valve, 35 GPM, 3.5 Second, SAE 16 ports, 3000 PSI _____	\$2,715.00
13859	^Servo Type Hydraulic Flow Control Valve, 5 GPM, 3.5 Second, SAE 8 port, 3000 PSI _____	\$1,654.00
13860	^Servo Type Hydraulic Flow Control Valve, 20 GPM, 3.5 Second, SAE 16 ports, 3000 PSI _____	\$2,715.00
13872	Y Cable, 3 Pin MP 150, 1 Tower & 2 shrouds, 12', (1 - speed signal in & 2 - out) _____	\$187.20
14012	WeatherPak Fuse Holder, w/ leads, w/o fuse _____	\$42.64
14019 B	Radar Interface Cable, 4-pin DJ to 3-pin MP, Vansco® _____	\$129.00
14025	Radar Interface Cable, 4-pin DJ to 3-pin WP, Vansco® _____	\$127.00
14026	*4-pin DJ Amp to Dickey JOHN®/Cannon connector, 1' _____	\$172.00
14027	4-pin DJ Amp to Dickey JOHN®/Packard connector, 1' _____	\$172.00
14028	*4-pin DJ Amp to Dickey JOHN®/Deutsch connector, 1' _____	\$172.00
14029	4-pin DJ Amp to Magnavox/Packard connector, 1' _____	\$172.00
14030	4-pin DJ Amp to Raven/Conxall connector, 1' _____	\$172.00
14031	*4-pin DJ Amp to Spraying Systems/Deutsch connector, 1' _____	\$172.00
14039	4-pin DJ Amp to Dickey JOHN®/Ford connector, 1' _____	\$172.00
14103	Extension Cable, 7-pin MP 150/480, 2-10 & 5 -18 gauge, 15' _____	\$364.32
14108	Tower Dust Cover, 7-pin MP, male _____	\$34.10
14109	Shroud Dust Cover, 7-pin MP, female _____	\$34.10
14142	Extension Cable, 10-pin MP 150, 50' _____	\$506.84
14146	Extension Cable, 7-pin MP 150/480, 2-10 & 5 -18 gauge, 5' _____	\$194.70
14147	Extension Cable, 7-pin MP 150/480, 2-10 & 5 -18 gauge, 10' _____	\$281.69
14214	Radar Interface for in-cab John Deere® MP 150 connector _____	\$127.00
14215	Radar Interface for Dickey JOHN®/AMP connector _____	\$192.00
14216	*Radar Interface for Dickey JOHN®/Cannon connector _____	\$192.00
14217	Radar Interface for Dickey JOHN®/Deutsch connector _____	\$192.00
14218	Radar Interface for Dickey JOHN®/Ford connector _____	\$192.00
14219	Radar Interface for Dickey JOHN®/Packard connector _____	\$192.00
14220	Radar Interface for Magnavox, Phillips/Packard connector _____	\$192.00
14221	Radar Interface for Raven/Conxall connector _____	\$192.00
14222	Radar Interface for in-cab John Deere® MP 150 connector with y-cable _____	\$192.00
14232	Hose Barb, 1/4" x 3/8" orifice, (3/32) _____	\$15.36

\*NCNR

^One year warranty

## INDEX BY PART NUMBER

14236	Extension Cable, 7-pin MP 150/480, 2-10 & 5 -18 gauge, 20'	\$442.77
14237	Extension Cable, 7-pin MP 150/480, 2-10 & 5 -18 gauge, 25'	\$516.51
14282	Boot for 1" Whirlwind™ sensor	\$24.46
14283	Boot for 1 1/4" Whirlwind™ sensor	\$26.30
14286-P A	FM270 P Flowmeter, 3.5-70 GPM, 225 PSI, M200 flange, PP, SS, nylon & Hastelloy	\$527.00
14286 C	FM270 Flowmeter, 3.5-70 GPM, 225 PSI, M200 flange, PP, SS, nylon & Hastelloy	\$827.00
14311	Main Harness, NH3, SprayMate™ & SprayMate™ II, 10'	\$202.02
14313 F	Harness, flow, control, boom, WPT-PGS, SprayMate™ II	\$308.91
14314	Ignition Cable, 72"	\$42.97
14315 C	Power (battery) Cable, 2-pin WP, 10 Amp fuse, 15'	\$146.20
14316	Extension Cable, 10-pin MP 150, 5-16 & 5-20 gauge, 10'	\$223.65
14317	Extension Cable, 10-pin MP 150, 5-16 & 5-20 gauge, 15'	\$268.87
14318	Bulkhead Console Power Boom Harness, 10'	\$514.37
14319	Bulkhead Console Boom Branch Harness, 10'	\$282.01
14320	Bulkhead Console Flow, Servo, Run/Hold Harness, 10'	\$196.65
14324	Adapter Cable, bulkhead console speed, 3'	\$66.51
14348-P B	FM1500 P SS LF Flowmeter, 3.5-70 GPM (13-265 lpm) 500 PSI (35 Bar)	\$1,020.00
14348 E	FM1500 SS LF Flowmeter, 3.5-70 GPM, 500 PSI, 1 1/2" FPT, SS & nylon & Hastelloy	\$1,365.00
14363	Extension Cable, 10-pin MP 150, 5-16 & 5-20 gauge, 5'	\$150.84
14364	Extension Cable, 10-pin MP 150, 5-16 & 5-20 gauge, 20'	\$330.30
14365	Extension Cable, 10-pin MP 150, 5-16 & 5-20 gauge, 25'	\$388.39
14366	Main Harness, NH3, MT-3405™ F & F II & MT-9000 w/ bulkhead connection, 10'	\$392.04
14380	Cable for John Deere® Performance Center (7000, 8000, 9000, Track Series), 1'	\$172.00
14381	Shaft-Trak™ Console (standard)	\$652.00
14419	Extension Cable, 10-pin MP 150, 5-16 & 5-20 gauge, 50'	\$666.77
14459	*Blockage Module	\$741.81
14463	*In-Line Servo Valve Adapter Cable, (MT-400™ with S)	\$40.54
14469	Solenoid Adapter Cable, 3-pin WPS to 1/4" QD	\$34.89
14471	RPM Sensor Kit, RPM sensor, w/ molded shaft adapter, 6 magnets	\$130.64
14473 C	Branch Harness, Shaft-Trak™, 6 sensor	\$406.25
14479	System Manual, Whirlwind™	\$15.23 NET
14482	Extension Cable, 5-pin MP 150, 5'	\$93.27
14483	Extension Cable, 5-pin MP 150, 10'	\$112.63
14484	Extension Cable, 5-pin MP 150, 15'	\$137.43
14485	Extension Cable, 5-pin MP 150, 20'	\$161.21
14486	Extension Cable, 5-pin MP 150, 25'	\$185.55
14501	Motor Lead Extension Cable, 2-pin WP, 10 Amp EMD, 5'	\$74.25
14519	Run/Hold Foot Switch, w/ cable	\$300.13
14536	Molded Shaft Adapter Kit, w/ 10 magnets	\$78.00
14553	Extra Main Harness Kit, (C-97-LR), (includes 13181, 13090 and 01530)	\$446.69
14582	Harness, speed/flow with run/hold, 10'	\$149.78
14583	Harness, speed/flow with Run/hold, 30'	\$260.51
14584	Boom Branch Harness, 10'	\$270.95
14585	Boom Branch Harness, 30'	\$499.88
14588	Cable, 16 Ga 5-pin MP Ext., 15'	\$231.79
14589	Cable, 12 Ga 2-conductor WP Ext, 15'	\$120.60
14600	Power/Module Cable , 5-pin MP, Whirlwind™, 20'	\$255.15
14607	Cable, local speed	\$187.46
14611	Adapter Cable, Raven flowmeter interface to MT, w/ 5V regulator	\$262.11
14672	*Shaft Module	\$741.81
14684	Connector Replacement Kit, 7-pin MP, w/ both halves, pins and seals	\$52.14
14689	Flow Sensor, Hall-effect, 3-pin WP	\$130.36
14690	Fan Module	\$727.90
14691	*Bin Level Module	\$727.89
14728	Pressure Gauge Bracket, MC-10, narrow console, (gauge not included)	\$50.00

\*NCNR

^One year warranty

## INDEX BY PART NUMBER

14778	Adapter Cable, 3-pin MPS, pins A & C to flying leads generic run/hold adapter, 30'	\$69.00
14793	Bulkhead Console Run/Hold Adapter Cable	\$99.69
14799	Pressure Gauge Bracket for MC-25, (gauge not included)	\$38.00
14808	Connector Replacement Kit, 5-pin MP, w/ both halves, pins and seals	\$35.36
14810	Radar Adapter for in-cab John Deere® MP 150 connector	\$73.00
14811	Radar Adapter for in-cab John Deere® MP 150 connector w/ Y-cable	\$84.00
14812	Radar Adapter for Dickey JOHN®/AMP connector w/ Y-cable	\$152.00
14813	Radar Adapter for Dickey JOHN®/Cannon connector w/ Y-cable	\$152.00
14814	Radar Adapter for Dickey JOHN®/Deutsch connector w/ Y-cable	\$152.00
14815	Radar Adapter for Dickey JOHN®/Packard connector w/ Y-cable	\$152.00
14816	Radar Adapter for Dickey JOHN®/Ford connector w/ Y-cable	\$152.00
14817	Radar Adapter for Raven/Conxall connector w/ Y-cable	\$152.00
14818	Radar Adapter for Magnavox/Phillips/Packard connector w/ Y-cable	\$152.00
14829-P A	FM10/100 P Flowmeter, 10-100 GPM, 225 PSI, M200 flange, SS, PP & nylon & Hastelloy	\$562.00
14836	Turbine for FM750 GFN, SS, FM1000 SS, FM270, FM10/100 and FM1500 SS	\$155.84
14851	Strainer Plug, w/ Alnico magnet, NH3	\$103.97
14869 P	SprayMate™ II Console	\$998.00
14885	^Servo Type Hydraulic Flow Control Valve, 10 GPM, 3.5 Second, SAE 8 ports, 3000 PSI	\$1,654.00
14904	System Manual, MT-2405 F™ II, (NH3 Specific)	\$15.23 NET
14914	Shaft-Trak™ Console (low RPM)	\$652.00
14926	Radar Adapter, 4-pin DJ to 3-pin MPS (Vansco®)	\$84.00
14935	MT-2405™ II Console	\$799.00
14943	System Manual, SprayMate™ II	\$15.23 NET
14946	System Manual, MT-3405 F™ II, (NH3 Specific)	\$15.23 NET
14955	System Manual, MT-NH3™ II	\$15.23 NET
14956 B	MT-NH3™ II Console	\$1,455.00
14966 J	SodPro™ II Console	\$777.00
14983	Harness Branch, servo, flow, RPM	\$279.83
15854 A	Adapter Cable, 4-wire control valve	\$89.83
15855 A	Adapter Cable Kit, 4-wire control valve (w/14315C power cable)	\$195.24
15861 A	Adapter Cable, CPC male (old style) connector, SprayMate™ Plus to 440, 10'	\$258.09
15871 A	Parallel Boom "Y" Cable, Dual ISOmod™	\$179.19
15891 B	IBIC Breakaway Implement Cable, w/ power connection, 30'	\$1,246.00
15894 A	Bearing Assembly Rebuild Kit for Poly Bearing Housing w/bearing for FM270, FM10/100, FM1500	\$187.34
15909 A	^Hydraulic Motor Seal Kit	\$225.05
16002 A	Adapter Cable, MT control valve to Raven, 9"	\$139.72
16003 A	Adapter Cable, MT on/off KZValve® to Raven, 9"	\$142.62
16004 A	Adapter Cable, electro-magnetic flowmeter to Raven interface cable, 10'	\$246.15
16005 A	Adapter Cable, electro-magnetic flowmeter to John Deere® interface cable, 10'	\$105.15
16006 A	Adapter Cable, electro-magnetic flowmeter to TeeJet® interface cable, 10'	\$124.80
16008 A	Adapter Cable, SprayMate™ Plus to Raven CR7	\$252.31
16013 A	Branch Cable, Dual ISOmod™, 6 section ZV (zipvalve), 10'	\$416.00
16014 A	Branch Cable, Dual ISOmod™, 12 section ZV (zipvalve), 10'	\$777.00
16031 A	Y Cable, 2 Pin MP 150, 1 Shroud & 2 towers, 10'; (7-section RateKing™ parallel boom)	\$83.00
16032 A	Parallel Boom "Y" Cable Kit, RateKing™ Dual, 7 section	\$573.00
16041 A	ISOBUS Tap Cable, 12-pin Deutsch, Case IH® 2100 Series Planter	\$255.00
16087 A	Relay Assembly, 40 Amp, with multifunction enable	\$210.78
16088 A	Adapter Cable, MT to Raven shutoff	\$192.40
16129 A	Servo Valve, M200 flanged or 1 1/2" FPT w/ 1" butterfly, Raven, 2 pin molded	\$627.00
16130 A	Servo Valve, M200 flanged or 1 1/2" FPT w/ 1 1/2" butterfly, Raven, 2 pin molded	\$627.00
16131 A	FM750 GFN Housing Half, w/ bearing, (one half of flowmeter)	\$253.00
16132 A	FM750 GFN LF Housing Half, w/ bearing, (one half of flowmeter)	\$309.00
16148 A	Servo Valve, M200 flanged or 1 1/2" FPT w/ 1" butterfly, Deutsch, 2 pin molded	\$627.00
16149 A	Servo Valve, M200 flanged or 1 1/2" FPT w/ 1 1/2" butterfly, Deutsch, 2 pin molded	\$627.00
16153 A	Adapter Cable, Dual ISOmod™ to Raven 440, w/CPC conn.	\$1,081.31

\*NCNR

^One year warranty



## INDEX BY PART NUMBER

16161 A	^MM528 Flowmeter, 26.5 to 528 GPM, 145 PSI, 3" MPT, PP & SS _____	\$1,558.98
16165 A	Rebuild Kit for FM1500 PA, w/ turbine, for NH3 _____	\$361.73
16199 A	ISOmod™ Adapter Cable , M/P 3-pin to DB9, 7" _____	\$88.64 NET
16200 A	ISOmod™ Programming Cable Kit, M/P 150 _____	\$88.00 NET
17010 M	GSC-1000™ Console, STD control _____	\$1,536.00
17011 L	GSC-1000™ Console, PWM control _____	\$1,536.00
17020	System Manual, MT-3405™ FTW II _____	\$15.23 NET
17037	System Manual, SodPro™ II _____	\$15.23 NET
17040	System Manual, GSC-1000™ _____	\$15.23 NET
17077	Power Harness, speed, run/hold _____	\$186.29
17095	Extension Cable, 10-pin MP 150, 30' _____	\$324.70
17096	Extension Cable, 10-pin 40' MP _____	\$390.09
17108	Adapter Cable, Rawson/Mid-Tech flow sensor, 1' _____	\$48.83
17144	Bearing Assembly Rebuild Kit w/ ruby balls for FM750 SS, FM1000 SS and FM1500 SS, w/ turbine ____	\$192.51
17147	Bearing Assembly Rebuild Kit w/ ceramic balls for FM750 SS, FM1000 SS and FM1500 SS, w/ turbine_	\$192.51
17148	Branch Harness, channel 2 liquid, MT-3405 D™, 10' _____	\$267.16
17158	Ball Valve Adapter Cable, 3-boom 2-wire, RoadMaster™ & SprayMate II™ _____	\$574.45
17159 A	Bulkhead Console 5-boom 2-wire Ball Valve Adapter Cable _____	\$827.94
17176	Harness, power, speed, RPM, run/hold, Calc-An-Acre™ II _____	\$207.14
17184	Channel 2 Liquid Harness, MT-3405 D™ _____	\$416.00
17185 A	Calc-An-Acre™ II Console _____	\$478.00
17186 A	Flow-Trak™ II Console _____	\$865.00
17192	System Manual, Calc-An-Acre™ II _____	\$15.23 NET
17193	System Manual, Flow-Trak™ II _____	\$15.23 NET
17194	Power Harness, flow, speed, run/hold, Flow-Trak™ II _____	\$255.15
17200	Relay Kit, Flow-Trak™ II _____	\$187.54
17269	Extension Cable, 10-pin MP 150, 45' _____	\$428.53
17279	Adapter Cable, EMD enable _____	\$25.86
17289 H	ProPlant™ Console _____	\$1,882.00
17302	Bearing Assembly Rebuild Kit w/ ruby balls for FM270 and FM10/100/ w/ turbine _____	\$168.31
17307	Section Branch Harness, 1-3 sections, 20' _____	\$198.31
17308	Section Branch Harness, flow with servo/RH, 1-3 sections _____	\$331.35
17316	Parallel Boom Harness Kit, MT-3405 D™ _____	\$1,247.00
17320 A	Toolbar Bracket _____	\$331.95
17321 C	Motor Bracket _____	\$277.77
17322	Sprocket, Idler #40, 32 x 16 _____	\$395.12
17323	Sprocket, Idler #40, 16 x 16 _____	\$148.30
17324	Adapter Cable, MT servo to Raven (old style), 1' _____	\$67.00
17325	Adapter Cable, MT flow/speed sensor w/ 3 pin MP to Raven/Conxall, 1' _____	\$108.00
17329	System Manual, ProPlant™ _____	\$15.23 NET
17338	Astro™ Adapter, 3-pin MP to MT-3000/5000 3-pin WP _____	\$84.75
17339	Section Harness, power, 15' _____	\$323.76
17351	Toolbar U-Bolt, 7" _____	\$24.87
17358	Section Harness, 1 section, 20' _____	\$76.15
17359	Harness, flow, servo, run/hold , 1 section, 20' _____	\$224.53
17360	Harness, flow, servo, run/hold, 15' _____	\$241.61
17370	ProPlant™ Variable Rate Token, green _____	\$240.60
17388	Sprocket, #40, 32 Tooth, 7/8" Split _____	\$240.60
17389	Radar Mount Kit (new style), Vansco® _____	\$59.74
17392	Speed/Flow Sensor, Hall-effect w/ MP shroud, 1' _____	\$102.41
17394	Sprocket, #40, 32 Tooth, 3/4" Split _____	\$240.60
17395	Bolt/Fastener Kit, hydraulic drive assembly _____	\$32.51
17396	Drive Chain Kit, #40, 10' _____	\$83.77
17398	Secondary Drive Fittings Kit _____	\$67.09
17399	Primary Drive Fittings Kit _____	\$377.83

\*NCNR

^One year warranty

## INDEX BY PART NUMBER

17415	Extension Cable, 7-pin MP 150/480, 2-10 & 5 -18 gauge, 50'	\$913.42
17419	Boom Branch Harness, MT-3407 F™ II, 10'	\$261.45
17420	Servo, Flow, Boom Branch Harness, MT-3407 F™ II, 10'	\$212.21
17433	Astro™ Adapter, 4-pin AMP to 3-pin MP	\$268.95
17436	Boom Branch Harness, MT-3405 F™ II, 10'	\$246.71
17442 B	MT Hall-effect flow/speed sensor to Raven	\$158.70
17444	Power Cable, 2-pin MP280, 25 Amp fuse, 10'	\$147.10
17445	Extension Cable, 2-pin MP 280, 10'	\$123.05
17446	Extension Cable, 2-pin MP 280, 20'	\$193.32
17447	Motor Cable, 2-pin MP280, 15'	\$134.35
17448	Motor Cable, 2-pin MP280, 20'	\$169.55
17449	Motor Cable, 2-pin MP280, 25'	\$204.78
17450	Motor Cable, 2-pin MP280, 30'	\$239.98
17501	Y Cable, 2 Pin MP 280, 1 Shroud & 2 towers, 20", (25 Amp MC dual motor)	\$122.75
17514 R	RoadMaster™ Console (standard control)	\$1,959.00
17523	Remote RoadMaster™ Blast, Run/Hold Cable, w/ mini-din connector	\$73.03
17528	Adapter Cable, Raven servo valve (old style) to MT, 8"	\$50.16
17529	Multi Section Branch Harness, NH3, 1-5 sections, 2'	\$251.86
17536	Astro™ Adapter, 3-pin WP to 3-Pin MP	\$54.90
17539	Adapter Cable, MT servo to PWM valve	\$45.51
17539	Adapter Cable, MT servo to PWM valve	\$45.51
17544	System Manual, RoadMaster™, STD	\$15.23 NET
17545	System Manual, RoadMaster™, PWM	\$15.23 NET
17546 P	RoadMaster™ Console (PWM control)	\$1,959.00
17554	Drive Chain Kit, #50, 10'	\$143.19
17555	Sprocket, Idler #50, 32 x 16	\$476.31
17556	Sprocket, 50-16 x 40-16 drive	\$135.07
17557	Sprocket, #50, 28 Tooth, 7/8" Hex Split	\$324.22
17558	Sprocket, #50, 28 Tooth, 3/4" Hex Split	\$324.22
17560	RoadMaster™ Blast/Run/Hold Remote Switch Box, w/ circular connector (old style)	\$246.00
17576	^Hydraulic Motor/Shutoff Valve Assembly, 4.9 CID, (no sprockets)	\$2,318.00
17582	Adapter Cable, w/ power, Raven / Trimble® EZ Boom® 2010 to MT, 10'	\$608.66
17584	Adapter Cable, NH3, 1 section, 1'	\$195.70
17599	Multi Section Boom Master Module, Deutsch connectors, 1-10 sections	\$518.52
17608	Adapter Cable, w/o power, Topcon 30S ECU to MT Liquid/NH3, 10'	\$558.94
17627	DirectConnect™ Harness Kit for Trimble® EZ Boom™ 2010, liquid, 1-7 section	\$1,081.00
17628	DirectConnect™ Harness Kit for Raven 440/450, liquid	\$1,081.00
17643	Adapter Cable, w/o power, Greenstar™ to MT Liquid/NH3, 10'	\$523.00
17674	^Lift-N-Go Kit, control box, air cylinder, brass T fitting, 30' air hose, accessory bag	\$562.58
17696	Seal Kit for SAFi NH3 Valve, (Velan)	\$438.64
17739	Multi Section Boom Master Module, 1-5 sections	\$342.06
17741	SAFi Cover O-ring, (New Style)	\$7.93 NET
17766	Trak-Record II Console	\$966.69
17767	System Manual, Trak-Record II	\$15.23 NET
17771	Power Cable	\$54.13
17782	Auto Section Cable, SprayMate II™	\$383.00
17786	Multi Section Adapter Cable, SprayMate II™, NH3, 10'	\$228.63
17787	^USB Flash Drive, 128meg	\$75.72 NET
17789	Adapter Cable for in-cab John Deere® 30 Series, 7-pin Amp	\$152.00
17811	Radar Adapter for in-cab John Deere® 30 Series 7-pin Amp	\$152.00
17827 A	Adapter Cable for electro-magnetic flowmeter, w/ divide by 8 interface	\$213.58
17842	Adapter Cable for electro-magnetic flowmeter w/o divide by 8 interface	\$95.34
17844	Multi-Section Branch Harness, NH3	\$262.79
17846	*Adapter Cable, hydraulic poppet, 3-pin WPS to 2-pin MP tower	\$32.67
17857	Adapter Cable, w/o power, AgLeader® DirectCommand™ to MT Liquid, 10'	\$647.33

\*NCNR

^One year warranty



## INDEX BY PART NUMBER

17858	Suction Cup Mounting Kit for Console _____	\$178.00
17871	Power Cable, 2-pin MP 280, w/ 40 Amp fuse, old style 40 Amp EMD, 20' _____	\$255.00
17872	Motor Lead, 2-pin MP 280, old style 40 Amp EMD, 4' _____	\$69.22
17880	Radar Interface for in-cab John Deere® 30 Series 7-pin Amp for LR products _____	\$199.76
17881	Right or Left Section Branch Harness, DrillMaster™ _____	\$256.16
17882	Center Section Branch Harness, DrillMaster™ _____	\$167.58
17883	PWM Run/Hold Cable, DrillMaster™ _____	\$120.45
17884 A	FM750 LF GFN Insert _____	\$64.47
17885	Turbine for FM750 LF, FM270 LF and FM1500 LF _____	\$157.37
17887 D	FM750 GFN LF Flowmeter, .5-12 GPM, 150 PSI, 3/4" FPT, nylon & Hastelloy _____	\$616.00
17891	DirectConnect™ T-Adapter for TeeJet® 230 BP/BoomPilot® _____	\$537.00
17892	Low Rate Conversion Kit, NH3500 _____	\$435.44
17894	Mounted Branch Harness, DrillMaster™ _____	\$270.31
17899 G	DrillMaster™ Console _____	\$1,366.00
17913	Strainer Gasket, NH3500, NH3, 1", teflon _____	\$71.61
17914	Strainer Screen, Liquifier NH3, 1.25", #20, SS _____	\$71.61
17915	Strainer Gasket, Liquifier NH3, 1.25", teflon _____	\$93.14
17917	^Proximity Sensor, w/ 6" lead _____	\$175.00
17922	RPM Sensor Kit, proximity or gear tooth sensor, w/ 6" cable, mounting bracket _____	\$255.19
17924	Adapter Cable, GS2, 16-pin to 37-pin CPC _____	\$355.64
17934	Adapter Cable, servo polarity reversal _____	\$35.88
17941	Branch Cable, AgLeader® DirectCommand™ to NH3 _____	\$697.57
17942	Adapter Cable, AgLeader® DirectCommand™ to Single Section _____	\$42.11
17943	Multi-Section Boom Master Module, AgLeader® DirectCommand™ _____	\$355.03
17962	Control Harness, Liquid/NH3, 7 section, GS2,3 10' _____	\$954.00
17965	Reed Flow Sensor for FM750 GFN Flowmeter (P/N 11501) _____	\$85.72
17972 A	^KZValve® NH3 Shutoff Valve, 1" _____	\$1,428.59
17973 A	^Seal Kit for KZValve, NH3, 1" _____	\$93.77
17985 A	Power Cable, 2-pin molex, 10 Amp fuse, 10' _____	\$71.30
17986	Motor Cable, MC-10, 2-pin molex to WP, 20' _____	\$65.07
17995	Bracket, NH3500, Low Rate Support _____	\$66.58
17996	MC-10 Manual Controller only, 10 amp _____	\$274.00
17997	MC-25 Manual Controller only, 25 amp _____	\$567.00
18000	Nipple, 3/4" X Close blk schedule 40 _____	\$7.74
18001	Nipple, 3/4" X 12" blk schedule 40 _____	\$38.53
18003	Coupling 1" x 3/4", (Low Rate Kit) _____	\$21.10
18004	Hose, NH3, 1" x 3', (Low Rate Kit) _____	\$507.89
18005	Primary Drive Fittings Kit _____	\$327.26
18006	Hydraulic Control Valve Remote Mount Bracket _____	\$64.47
18008	Electric Motor Driver Kit, STD, 10 Amp _____	\$569.00
18014	Nipple, 3/4" X 2" blk schedule 40 _____	\$8.21
18018	Cable, pump, 10' _____	\$84.77
18019	Cable, pump, 30' _____	\$189.75
18026	Drawn Left/Right Branch Harness, 2-Section, DrillMaster™ _____	\$175.27
18031	^Hydraulic Motor Cross Port Plug (replaces shutoff valve on motor for PWM control) _____	\$96.17
18034	Multi-Section EMD Adapter Cable, SprayMate™ II _____	\$114.85
18041	Radar Adapter for in-cab John Deere® 1-pin MP280 _____	\$32.00
18048	Y Cable, 3 Pin MP 150, 1 Shroud & 2 towers, 12', (2 - R/H switches in & 1 - out) _____	\$99.86
18072 B	Electric Motor Driver Module, 10 Amp STD _____	\$390.07
18076	Speed/Flow Sensor, Hall-effect w/ Cannon connector, Hiniker _____	\$143.47
18078	^FM2000 P Flowmeter, 19-198 GPM, 285 PSI, M200 flange, nylon & SS & ceramic _____	\$1,513.00
18080	System Manual, Twin Pump™ Controller _____	\$15.23 NET
18098	Calibration Lockout Key, set of two, RoadMaster™, SprayMate™ Plus _____	\$4.68 NET
18104 C	Electric Motor Driver Module, 10 Amp PWM _____	\$390.07
18105	Adapter Cable for old style polmac square wave sensor, MP shroud, 3' _____	\$189.30

\*NCNR

^One year warranty

## INDEX BY PART NUMBER

18108	Electric Motor Driver Kit, PWM, 10 Amp _____	\$569.00
18111	Shroud, w/ jumper wire, 2-Pin WP, female _____	\$15.22
18137	Power Cable, 3-pin WP, 10 Amp fuse, 20' _____	\$143.66
18154 A	FlowMate™ Console _____	\$473.00
18155 B	Power Cable, 2-pin WP, 10' _____	\$46.94
18157	Fuse & Terminal Kit, 1 Amp _____	\$16.08
18177	^MM238 Flowmeter, 12 to 238 GPM, 290 PSI, 2" MPT, PP & SS _____	\$1,558.99
18183	Heat Exchanger, Liquifier, Liquifier Max , 1 1/2" MPT _____	\$2,642.64
18185	^Servo Valve, NH3, Liquifier Max, 1 1/2" _____	\$1,699.17
18186	^Shutoff Valve, Liquifier Max, NH3, 1 1/2" _____	\$1,699.17
18187 A	^Servo Valve, NH3, Liquifier, 1" _____	\$1,433.38
18188	Hose Barb, 1/4" x 3/8" orifice, (3/64) _____	\$15.36
18205	Flow Sensor for FM2000 and FM3000 polmac flowmeters _____	\$504.66
18209	System Manual, SprayMate™ Plus, (prior to 2014) _____	\$15.23 NET
18221	Elbow, 3/4" MPT x 3/8", nylon _____	\$10.58
18222	Elbow, 1/4" x 1/4", nylon _____	\$10.58
18229	^FM3000 P Flowmeter, 40-396 GPM, 285 PSI, 3" MPT, nylon & SS & ceramic _____	\$1,988.00
18264	Servo Branch Harness, AgLeader® Direct Command™ Flow _____	\$233.32
18265	7-Boom Branch Harness, AgLeader® Direct Command™ Flow _____	\$290.73
18267	Relay, 50A 12v SPST, SprayMate™ II fertilizer kit _____	\$74.66
18279	Astro™ Adapter, 3-pin MP to Raven/Dickey JOHN®/Amp Y-cable _____	\$158.90
18280	Harness, flow, control, boom, WPS-PGS, SprayMate™ Plus _____	\$324.03
18287	Adapter Cable, 3-pin WPS to WPS _____	\$48.12
18287	Cable, 3-pin WPS to WPS adapter, (converts a WP output from a tower to a shroud) _____	\$48.12
18288	Extension Cable, 2-pin MP 280, 5' _____	\$87.82
18289	Extension Cable, 2-pin MP 280, 15' _____	\$158.25
18290	Extension Cable, 2-pin MP 280, 25' _____	\$228.54
18294 D	DirectConnect™ Liquid Fertilizer Cable for Case IH® AFS Pro 600/700, liquid, 10' _____	\$270.00
18302	Strainer, w/ magnet assembly, NH3, 1 1/2" _____	\$407.19
18307	Strainer, Liquifier Junior, Liquifier Junior, ultra low rate _____	\$285.21
18319	Radar Adapter for in-cab Case IH® MX (Britax) _____	\$152.00
18324	Main Branch Harness for Topcon _____	\$677.82
18325	Harness, speed/flow with servo/pressure, Topcon _____	\$351.91
18326	DirectConnect™ Harness, 1-6 sections _____	\$358.13
18327	DirectConnect™ Harness, 7-10 sections _____	\$315.89
18328	DirectConnect™ Harness Kit for Trimble® Field IQ™, 1 section, liquid/NH3, 7' _____	\$427.00
18329	Main Branch Harness, Trimble®, 1 section _____	\$594.24
18330	Branch Cable, Trimble® _____	\$340.54
18348	Poppet Valve Assembly _____	\$197.61
18349	DirectConnect™ Trimble® Field IQ™ Harness Kit, liquid, 1-6 sections, 7' _____	\$726.00
18350	*DirectConnect™ Trimble® Field IQ™, Harness Kit, liquid, 1-12 sections, 7' _____	\$932.00
18384	Electric Motor Driver Module, 40 Amp STD  _____	\$808.09
18385	Electric Motor Driver Module, 40 Amp PWM  _____	\$808.09
18413	Boom Y cable, MT-3405™ series _____	\$190.00
18419	Power Cable, 2-pin MP 480 Power, 20' w/ 40 Amp fuse _____	\$244.94
18420	Motor Lead , 2-pin MP 480, 4' _____	\$72.18
18421 A	Extension Cable, 2-pin MP 480, 20' _____	\$215.00
18422	Y Cable, 2 Pin MP 480, 1 Shroud & 2 towers, 2', (40 Amp EMD dual motor) _____	\$132.31
18436 A	Extension Cable, 2-pin MP 480, 15' _____	\$175.87
18448	^MM3 Flowmeter, .13 to 2.6 GPM, 290 PSI, 3/4" FPT, PP & SS _____	\$2,061.37
18449	^MM5 Flowmeter, .3 to 5 GPM, 290 PSI, 3/4" FPT, PP & SS _____	\$2,061.37
18450	^MM13 Flowmeter, .6 to 13 GPM, 290 PSI, 3/4" FPT, PP & SS _____	\$2,061.37
18451	^MM26 Flowmeter, 1.3 to 26 GPM 290 PSI, 1" FPT, PP & SS _____	\$2,061.37
18452	^MM53 Flowmeter, 2.6 to 53 GPM, 290 PSI, 1" FPT, PP & SS _____	\$2,061.37
18453	^MM106 Flowmeter, 5 to 106 GPM, 290 PSI, 1 1/2" FPT, PP & SS _____	\$2,061.37

\*NCNR

^One year warranty

## INDEX BY PART NUMBER

18454	^MM158 Flowmeter, 8 to 158 GPM, 290 PSI, 2" MPT, PP & SS _____	\$2,061.37
18456	DirectConnect™ Main Harness for GreenStar™ Rate Controller _____	\$483.00
18457 A	DirectConnect™ Control/Flow for GreenStar™ Rate Controller, 1 section _____	\$322.00
18458	DirectConnect™ Master/Relief/Agitation Cable for GreenStar™ Rate Controller, liquid/NH3 _____	\$258.00
18459	^KZ Shutoff Valve Actuator, NH3, 1", 1 1/2" _____	\$819.36
18465	Heat Exchanger, Liquifier Junior, ultra low Rate _____	\$2,642.62
18473	SafeGuard™ Console _____	\$1,135.00
18488	Cap, PP, w/ SS U-clip, no threads _____	\$7.29
18489	Plug, PP, FKM (Viton® type) o-ring, no threads _____	\$7.29
18493	Tee, PVC, w/ SS U-clip, FKM (Viton® type) o-ring _____	\$18.23
18510 C	U-clip, SS _____	\$2.34
18511	Sensor Cartridge, SafeGuard™, HDPE, green _____	\$4.13 NET
18514	Cartridge Retainer Clip _____	\$4.02
18515	Plug, PP, FKM (Viton® type) o-ring, 1/4" FPT _____	\$7.29
18516	Plug, PP, FKM (Viton® type) o-ring, 3/8" FPT _____	\$7.29
18517	Plug, PP, FKM (Viton® type) o-ring, 3/4" FPT _____	\$7.29
18521	O-ring, FKM (Viton® type) _____	\$8.00
18524	Cap, PP, w/ SS U-clip, 3/4" FPT _____	\$7.29
18525	Extension Cable, 6-pin MP150, w/ twisted pair, 15' _____	\$145.69
18529 A	Run/Hold Sensor Kit, whisker switch, (no magnetic mount) _____	\$294.92
18530 A	Magnet Mount for Implement Whisker Switch _____	\$129.75
18532 A	Harness, flow, control, boom, WPT-PGS, SprayMate™ Plus _____	\$324.03
18541	Run/Hold Sensor Kit, whisker switch, magnetic mount, 10' extension cable _____	\$366.57
18555	Heat Exchanger, Liquifier Junior _____	\$2,642.62
18599 A	FM750 LF SS Flowmeter, 1 - 9 gpm, 500 PSI, 3/4" FPT, SS & nylon & Hastelloy _____	\$1,031.00
18602	Astro™ Adapter, 3-pin MP to 3-pin MP/Dickey JOHN®/AMP Y-cable _____	\$158.90
18620	Cap, PP, w/ SS U-clip, 3/4" straight hose barb _____	\$7.29
18621	Cap, PP, w/ SS U-clip, 1" straight hose barb _____	\$7.29
18622	Plug, PP, FKM (Viton® type) o-ring, 3/4" straight hose barb _____	\$7.29
18623	Plug, PP, FKM (Viton® type) o-ring, 1" straight hose barb _____	\$7.29
18624	Plug, PP, FKM (Viton® type) o-ring, 3/8" hose barb w/ 90° elbow _____	\$7.29
18625	Plug, PP, FKM (Viton® type) o-ring, 1/2" hose barb w/ 90° elbow _____	\$7.29
18626	Plug, PP, FKM (Viton® type) o-ring, 1/4" John Guest w/90° elbow _____	\$16.11
18627	Plug, PP, FKM (Viton® type) o-ring, 3/8" John Guest w/ 90° elbow _____	\$16.48
18653	SafeGuard™ Sensor Mounting Spacer _____	\$4.34
18654	Connector Replacement Kit, 2-Pin MP 480, w/ both halves, pins and seals _____	\$46.83
18664	Adapter Cable, Raven flowmeter interface to MT, no regulator _____	\$146.46
18667	Dust Cover, 6-pin RCPTCL _____	\$12.14
18670	Plug, PP, FKM (Viton® type) o-ring, 5/16" John Guest w/ 90° elbow _____	\$17.58
18675 B	Control Branch Harness, RateKing™, 10' _____	\$377.10
18676 B	Control Branch Harness, RateKing™ Dual Plus Channel 2, 10' Dual Plus Channel 2 Harness _____	\$279.00
18687	Sensor Cartridge, SafeGuard™, PP, pink _____	\$4.13 NET
18688	Sensor Cartridge, SafeGuard™, HDPE, orange _____	\$4.13 NET
18689	Sensor Cartridge, SafeGuard™, HDPE, yellow _____	\$4.13 NET
18691	Sensor Cartridge, SafeGuard™, HDPE, blue _____	\$4.13 NET
18692	Sensor Cartridge, SafeGuard™, HDPE, red _____	\$8.76 NET
18693	Sensor Cartridge, SafeGuard™, HDPE, brown _____	\$6.93 NET
18694	Sensor Cartridge, SafeGuard™, HDPE, grey _____	\$6.93 NET
18695	Sensor Cartridge, SafeGuard™, HDPE, white _____	\$10.78 NET
18700 C	SprayMate™ Plus Console _____	\$1,496.00
18701 B	RateKing™ Plus Console, 5 section _____	\$1,806.00
18702 A	RateKing™ Dual Plus Console, 5 section _____	\$3,109.00
18715 A	RateKing™ Plus Console, 3 section _____	\$1,806.00
18716 C	RateKing™ Plus Console, 7 section _____	\$2,127.00
18717 A	RateKing™ Dual Plus Console, 3 section _____	\$3,109.00

\*NCNR

^One year warranty

## INDEX BY PART NUMBER

18718 A	RateKing™ Dual Plus Console, 7 section _____	\$3,592.00
18721	SafeGuard™ Sensor Bracket _____	\$12.43
18722	Connector Replacement Kit, 2-Pin MP 280, w/ both halves, pins and seals _____	\$28.63
18754	Pressure Sensor Cable, single, 15' _____	\$100.00
18754	Single Pressure Sensor Cable, Plus Series _____	\$100.00
18755	Dual Pressure Sensor Cable, plus console, 15' _____	\$176.97
18756	Extension Cable, 6-pin MP 150, 10' _____	\$107.35
18757	Pressure Sensor only, 150 PSI, 4 to 20mA _____	\$278.54
18758	Pressure Sensor only, 300 PSI, 4 to 20mA _____	\$278.54
18764	Pressure Harness Kit, single, w/ 15' sensor cable, 10' extension cable _____	\$149.32
18765	Pressure Harness Kit, dual, w/ 15' sensor cable, 10' extension cable _____	\$278.54
18767	Adapter Cable, power/master switch, MT-NH3™ _____	\$80.55
18770 A	System Manual, SprayMate™ Plus, (2014 to current) _____	\$15.23 NET
18774	Radar Adapter for in-cab Case IH® FMX _____	\$152.00
18775	^KZ Servo Valve Actuator, NH3, 1", 1 1/2" _____	\$893.17
18777	Harness Adapter Cable, SprayMate™ Plus Console to SprayMate™ II _____	\$100.25
18781-P B	FM270 P LF Flowmeter, .5-15 GPM, 225 PSI, M200 flange, PP, SS, & nylon & Hastelloy _____	\$584.00
18781 A	FM270 LF Flowmeter, .5-15 GPM, 225 PSI, M200 flange, PP, SS, & nylon & Hastelloy _____	\$888.25
18797 C	SafeGuard™ ISOmod™ Module _____	\$886.34
18802	Power Cable, 15 Amp fuse, 15' _____	\$344.92
18819	Section Branch Harness, 5 section WPT-PGS, 10' _____	\$285.39
18820	Section Branch Harness, 7 section WPT-PGS, 10' _____	\$326.74
18823	Extension Cable, 6-pin MP 150, 5' _____	\$67.99
18824	Extension Cable, 6-pin MP 150, 15' _____	\$127.05
18825	Extension Cable, 6-pin MP 150, 20' _____	\$178.89
18826	Extension Cable, 6-pin MP 150, 25' _____	\$186.98
18827	Extension Cable, 2-Pin MP 480, 5' _____	\$140.91
18828	Extension Cable, 2-Pin MP 480, 10' _____	\$160.96
18829	Extension Cable, 2-Pin MP 480, 25' _____	\$217.65
18830	Extension Cable, 7-Pin MP 150/480, 2-12 & 5 -20 gauge, 5' _____	\$159.41
18831	Extension Cable, 7-Pin MP 150/480, 2-12 & 5 -20 gauge, 10' _____	\$206.00
18832	Extension Cable, 7-Pin MP 150/480, 2-12 & 5 -20 gauge, 15' _____	\$243.19
18833	Extension Cable, 7-Pin MP 150/480, 2-12 & 5 -20 gauge, 20' _____	\$285.27
18834	Extension Cable, 7-Pin MP 150/480, 2-12 & 5 -20 gauge, 25' _____	\$327.11
18835	Extension Cable, 7-Pin MP 150/480, 2-12 & 5 -20 gauge, 50' _____	\$536.64
18836 B	System Manual, RateKing™ Dual Plus _____	\$14.94 NET
18844	System Manual, SafeGuard™ ISOmod™ _____	\$15.23 NET
18851	Adapter Cable, TeeJet® flow sensor (adapts a Teejet® flow sensor to MT flow input) _____	\$79.69
18864 A	System Manual, RateKing™ Plus _____	\$15.23
18872	Section Branch Harness, 3 section WPT-PGS, 10' _____	\$249.16 NET
18893	^MM2 Flowmeter, .08 to 1.6 GPM, 290 PSI, 3/4" FPT, PP & SS _____	\$2,061.37
18894	ISOBUS Tap Cable, 6-pin MP 150 _____	\$255.00
18895 A	ISOBUS Tap Cable, 12-pin Ampseal, John Deere® _____	\$255.00
18896	ISOBUS Tap Cable, 4-pin Delphi MP 630, Great Plains/Dickey JOHN® _____	\$255.00
18897	ISOBUS Tap Cable, 8-pin GT280, Case IH® _____	\$255.00
18921	IBIC Breakaway Implement Cable, no power connection, 10' _____	\$714.00
18922	Bearing Assembly Rebuild Kit for Bearing Housing w/bearing for FM270, FM10/100, & FM1500_ _____	\$320.81
18924 B	Electric Motor Driver Module, 10-Amp PWM w/ enable _____	\$393.97
18925	Electric Motor Driver Module, 40-Amp PWM w/ enable  _____	\$814.06
18927	Splitter Cable, PWM, runs up to 3 EMD's _____	\$108.41
18928	Secondary Pump Enable Relay Cable using a Multifunction Output _____	\$277.82
18941	Motor Lead, 2-pin WP, 4' _____	\$38.19
18944	Tap Cable (in-cab) Kit, w/ power cable, Deutsch DTM _____	\$255.00
18945	Tap Cable (in-cab) Kit, w/ power cable, Deutsch DT _____	\$343.00
18950	Tap Cable (in-cab) Kit, w/ power adapter, Deutsch DT _____	\$343.00

\*NCNR

^One year warranty

## INDEX BY PART NUMBER

18955	Adapter Cable Kit, ECU power _____	\$160.00
18963	O-ring, orifice plate _____	\$1.82
18967	Terminator Cable, w/TBC Plug, Deutsch DT _____	\$201.04
18968	Terminator Cable, w/TBC Plug, Deutsch DTM _____	\$223.00
18982	Power Cable, w/ 5A fuse kit, 10' _____	\$54.70
18985	Pressure Gauge Bracket, MC-10, (Deep Back, No Gauge) _____	\$69.07
18990 C	Relay Module, dual relays _____	\$364.57
18996	O-Ring for FM750 LF GFN insert _____	\$2.01
19016	Adapter Cable, 3-pin WPS section to 2-pin WPT solenoid _____	\$36.75
19017	Tee, PP, w/ SS U-clip, FKM (Viton® type) o-ring, fumigant compatible _____	\$18.23
19059	Flange Gasket and Clamp Kit, 2", (2 ea.) _____	\$53.14
19060	Sensor Cartridge, SafeGuard™, HDPE, black, high range, fumigant compatible _____	\$4.13 NET
19087	Relay Module, single relay _____	\$266.22
19088	Adapter Cable, PWM hydraulic control, 3-Pin WP tower to 2-Pin Deutsch DT06-2S, 6" _____	\$56.86
19093	Servo Valve, 1" butterfly, Viton® o-rings, 150 PSI _____	\$429.00
19094	Servo Valve, 1" high pressure butterfly, Viton® o-rings, 300 PSI _____	\$499.00
19095	Servo Valve, 1" butterfly, aqueous ammonia, EPDM o-rings, 150 PSI _____	\$429.00
19096	Servo Valve, M200 flanged or 1 1/2" FPT, 1" butterfly, Viton® o-rings, 150 PSI _____	\$600.00
19097	Servo Valve, M200 flanged or 1 1/2" FPT, 1.5" butterfly, Viton® o-rings, 150 PSI, M200 _____	\$600.00
19098	Servo Valve, M200 flanged or 1 1/2" FPT, 1" butterfly, aqua ammonia, EPDM o-rings, 150 PSI _____	\$600.00
19099	Servo Valve, M200 flanged or 1 1/2" FPT, 1 1/2" butterfly, aqua ammonia, EPDM o-rings, 150 PSI _____	\$600.00
19101 B	Servo Valve, NH3, Liquifier Junior, ultra low rate, 3/4" x 1" _____	\$1,534.00
19102 B	Servo Valve, NH3, NH3500, 3/4" x 1" _____	\$1,516.00
19103 B	Servo Valve, NH3, Liquifier Junior, 1" x 1" _____	\$1,484.00
19104 A	Liquid Servo Valve Replacement Powerhead (Viton), 2016-current _____	\$405.00
19170	Fuse Holder Kit _____	\$72.13
19295	Power Cable, 2-pin MP 480, 30' _____	\$231.94
19313 A	Extension Cable, 16-pin GT, 5' _____	\$192.77
19314 A	Extension Cable, 16-pin GT, 10' _____	\$292.45
19315 A	Extension Cable, 16-pin GT, 15' _____	\$392.41
19316 A	Extension Cable, 16-pin GT, 20' _____	\$496.33
19317 A	Extension Cable, 16-pin GT, 30' _____	\$695.98
19318 A	Extension Cable, 16-pin GT, 40' _____	\$895.51
19319 A	Extension Cable, 16-pin GT, 50' _____	\$1,095.16
19347	Extension Cable, 2-pin MP 480, 40' _____	\$356.72
19348	Extension Cable, 2-pin MP 480, 50' _____	\$383.57
19425 A	Flow Sensor for FM250 P polmac flowmeter _____	\$329.28
19444	Power Cable, 15' _____	\$99.73
19503 A	Liquid Servo Valve Replacement Powerhead, aqueous ammonia w/EPDM o-rings, 2016-current _____	\$405.00
19505	NH3 Servo Valve Replacement Powerhead, 2016-current _____	\$542.00
19507	Pressure Sensor Extension Cable, 50' _____	\$214.55
19508	Pressure Sensor Extension Cable, 25' _____	\$124.00
19603 B	System Manual, Dual ISOmod™ _____	\$15.23 NET
19604 A	Bulkhead Harness, Dual ISOmod™, 2' _____	\$701.25
19605 A	Branch Harness, Dual ISOmod™, Channel 1, 10' _____	\$328.80
19606 A	Branch Harness, Dual ISOmod™, Channel 2, 10' _____	\$329.00
19609	Liquifier Junior Upgrade Kit _____	\$73.05
19616 B	Extension Cable, 6-pin Amphenol twisted pair, 5' _____	\$92.73
19617 B	Extension Cable, 6-pin Amphenol twisted pair, 10' _____	\$126.58
19618 B	Extension Cable, 6-pin Amphenol twisted pair, 15' _____	\$161.15
19619 B	Extension Cable, 6-pin Amphenol twisted pair, 20' _____	\$195.73
19620 B	Extension Cable, 6-pin Amphenol twisted pair, 25' _____	\$230.32
19621 B	Extension Cable, 6-pin Amphenol twisted pair, 30' _____	\$264.91
19624 B	Adapter, 6-pin, M/P150 to Amphenol twisted pair, 15' _____	\$145.68
19625 A	Implement Switch Module, SafeGuard™, w/long Amphenol _____	\$308.47

\*NCNR

^One year warranty

## INDEX BY PART NUMBER

19667 A	Dual ISOmod™ Module _____	\$2,128.00
19669	Branch Harness, Dual ISOmod™, 6 section, 10' _____	\$331.00
19670	Branch Harness, Dual ISOmod™, 12 section WPT-PGS, 10' _____	\$600.00
19676 A	Adapter, 6-pin, M/P150 to Amphenol twisted pair, 25' _____	\$212.25
19681 A	Terminator, 6-pin, Amphenol tower _____	\$31.30
19682 A	Terminator, 6-pin, Amphenol shroud _____	\$22.15
19688	Tower Dust Cover, 6-pin Amphenol, male _____	\$17.89
19689	Shroud Dust Cover, 6-pin Amphenol, female _____	\$12.14
19690	Harness, SafeGuard™ ISOmod™, w/ Amphenol _____	\$791.95
19693 A	Connector Replacement Kit, 6-pin Amphenol, w/ SafeGuard™ Sensor _____	\$53.61
19694 B	Extension Cable, 6-pin Amphenol twisted pair, 2.5' _____	\$75.06
19700 C	IBIC Breakaway Implement Cable, w/ power connection, 10' _____	\$833.00
19703	Shroud Dust Cover, 16-pin GT, female _____	\$21.59
19713	Master Valve Cable, Trimble® Field IQ™, 7' _____	\$147.50
19721	DirectConnect™ Harness Kit for Trimble® Field IQ™, 1-6 sections, NH3, 7' _____	\$861.00
19722	*DirectConnect™ Harness Kit for Trimble® Field IQ™, 1-12 section, NH3, 7' _____	\$1,062.00
19727	DirectConnect™ Adapter Cable, TeeJet® ASC to RateKing™ _____	\$537.00
19731	Adapter Cable, 2-pin PWM control signal reversal adapter _____	\$30.03
19745	Extension Cable, 2-pin MP 480, 30' _____	\$237.25
19749	Section Relay Module Enable _____	\$89.83
19770	Adapter Kit, 2" full port Banjo flange, for mag. fl. kits 01826, 01827 _____	\$38.78
19771	Adapter Kit, 2" STD port Banjo flange, for mag. fl. kit 01901,01821,01822,01823,01824,01825 _____	\$45.25
19774	ISOBUS Extension Cable, 6-pin MP 150, 5' _____	\$212.15
19775	ISOBUS Extension Cable, 6-pin MP 150, 10' _____	\$232.68
19776	ISOBUS Extension Cable, 6-pin MP 150, 20' _____	\$273.63
19777	ISOBUS Extension Cable, 6-pin MP 150, 30' _____	\$314.71
19778	ISOBUS Extension Cable, 6-pin MP 150, 40' _____	\$355.79
19795	Bearing Assembly Rebuild Kit w/ ruby balls for FM750 SS NH3, w/ turbine _____	\$305.16
19797 A	FM750 LF SS for NH3 Flowmeter, 1 - 9 GPM, 500 PSI, 3/4" FPT, SS & nylon & Hastelloy _____	\$1,245.82
19798	FM1500 SS for NH3 Flowmeter, 10-130 GPM, 500 PSI, 1 1/2" FPT, PP & nylon & Hastelloy _____	\$1,653.78
19799 A	FM1500 SS LF for NH3 Flowmeter, 3.5-70 GPM, 500 PSI, 1 1/2" FPT, SS & nylon & Hastelloy _____	\$1,721.18
19811	NH3 Servo Valve Replacement Powerhead, retrofit 2005 model _____	\$542.00
19813	Bearing Assembly Rebuild Kit w/ ruby balls for FM1500 SS NH3, w/ turbine _____	\$311.21
19823	Tower Dust Cover, 16-pin GT, male _____	\$35.03
19824	Shroud Dust Cover, 2-pin MP 480, female _____	\$25.92
19825	Tower Dust Cover, 2-pin MP 480, male _____	\$22.06
19828	^MM106FL Flowmeter, 5 to 106 GPM, 290 PSI, M220 flange, PP & SS _____	\$2,061.37
19830	System Manual, Flo-Pro™ _____	\$15.23 NET
19834	Branch Harness, 10' _____	\$332.84
19835	Power Cable, 10' _____	\$79.63
19836 B	Flo-Pro™ Console _____	\$1,164.00
19837 A	Adapter Cable, pre-2017 sensors, JWPF Tower to Amphenol Shroud _____	\$17.00 NET
19838 A	Adapter Cable, pre-2017 sensors, JWPF Shroud to Amphenol Tower _____	\$17.00 NET
19857	ISOBUS Tap Cable Kit, w/ 6-pin MP150, 18894 and 18955 ECU power adapter cable _____	\$343.00
19862	System Manual, RateKing™ XRS _____	\$15.23 NET
19875	Rebuild Kit for FM1500 NH3 Bearing Housing, SS, w/ bearing for NH3 _____	\$369.96
19876	Relay Module _____	\$113.45
19877	Flo-Pro™ Relay Kit, 15 Amp max _____	\$248.00
19882	Trailer Branch Harness, RateKing™ XRS, 15' _____	\$837.36
19883	Tractor Harness, RateKing™ XRS, 5' _____	\$412.99
19884 C	RateKing™ XRS Console _____	\$2,644.00
19897	Adapter Cable, PWM hydraulic control, 3-Pin WP tower to 2-Pin Deutsch DT06-2S, 10' _____	\$68.54
19905	Adapter Cable, MT to Raven NH3 fast valve, 7" _____	\$274.88
19906	Adapter Cable, MT console to Raven Fast Valve, 3 pin M/P 150 shroud to 3 pin Conxall, 7" _____	\$90.00
19907	Adapter Cable, MT to Raven NH3 fast valve AND Raven NH3 shut-off, 7" _____	\$413.99

\*NCNR

^One year warranty



## INDEX BY PART NUMBER

19922 A	Adapter Cable, CPC female connector, SprayMate™ Plus to Raven 440, 10'	\$263.25
19928	Sensor Cartridge, SafeGuard™, HDPE, black, w/range extender, low range, fumigant compatible	\$11.92 NET
19951	Adapter Cable, USB to RS232	\$106.23 NET
19952	M12 Adapter Cable, WPS-PGS	\$138.44
19954	M12 Adapter Cable, MPS-PGS	\$135.90
19955 D	SprayMate™ XRS Console	\$1,871.00
19958 A	Control Branch Harness, SprayMate™ XRS, 15'	\$551.93
19959 A	System Manual, SprayMate™ XRS	\$14.94 NET
19960 A	Console Quick Mount kit, SprayMate™ XRS or any black plastic consoles	\$105.50
19963	Secondary Pump Enable Cable using Multifunction Output, includes 18928 & 18420 lead	\$352.00
19978 A	Cable, RateKing™ Plus to Raven Console	\$718.47
19979 A	Cable, RateKing™ Dual Plus to Raven Console	\$913.69
20182	FM500 Rotor, PP, w/ Nivapoint Shaft	\$114.86
20268	Adapter Cable for old style polmac analog sensor, WP shroud, 3'	\$189.30
20365	Strainer Assembly, NH3500	\$349.23
20486	Tubing, NH3500, 3/8" EVA	\$3.60
21612 B	Multi Section Module, DrillMaster™	\$590.62
21691 A	^KZ Valve®, 1", body only	\$599.65
21778	Run/Hold Switch Assembly, SprayMate™ Plus, RoadMaster™, DrillMaster™	\$116.30
21779	Power Switch Assembly for consoles	\$116.29
21963	Switch Assembly, run/hold, SprayMate™ II, MT-NH3™ II, GSC-1000™	\$116.29
21993	Cartridge Range Extender	\$18.63
22032	FM250 P Flowmeter, .08 to 1.6 GPM, 290 PSI, 1/4" NPT and 1/2" HB, IXEF & SS	\$635.00
40203	*Demonstration Display Adapter Cable, SprayMate™ II, RoadMaster™	\$52.41 NET
40204	*Demonstration Display Adapter Cable, MT-2405™ F II	\$104.31 NET
40205	*Demonstration Display Adapter Cable, MT-3405 F™ II, MT-3405 D™, MT-9000™	\$49.37 NET
40206	*Demonstration Display Adapter Cable, MT-NH3™ II	\$39.76 NET
40209	*Demonstration Display Adapter Cable, Calc-An-Acre™ II/Flow-Trak™ II	\$75.35 NET
40267	*Demonstration Display Adapter Cable, SprayMate™ Plus	\$48.81 NET
40311	*Demonstration Display Adapter Cable, RateKing™ Plus/Dual Plus	\$51.69 NET
40312	*Demonstration Display Adapter Cable, RateKing™ Dual Plus Channel 2	\$38.76 NET
40319 A	*Demonstration Display Indicator Light Assembly for Unit Multifunction	\$26.46 NET
40238	*Demonstration Display Adapter Cable, SprayMate™ XRS	\$47.86 NET
50052 A	Instruction Sheet, 7 section Parallel Boom Cable	\$8.51 NET
50173	Safety Manual, NH3	\$15.23 NET
50209	Instruction Sheet, Shaft-Trak™	\$8.51 NET
50236	Instruction Sheet, MC-25 Manual Controller	\$8.51 NET
50268	Instruction Sheet, Vansco® Radar	\$8.51 NET
50271	Instruction Sheet, MT-3407 F™ II	\$8.51 NET
50279	Instruction Sheet, Raven 440/450 NH3 DirectConnect™	\$8.51 NET
50291	Instruction Sheet, Raven 440/450 Liquid DirectConnect™	\$8.51 NET
50314	Instruction Sheet, Ag Leader® Insight Liquid DirectConnect™	\$8.51 NET
50318	System Manual, DrillMaster™	\$15.23 NET
50328	Instruction Sheet, Ag Leader® Insight NH3 DirectConnect™	\$8.51 NET
50332	Instruction Sheet, MC-10 Manual Controller	\$8.51 NET
50346	Instruction Sheet, FlowMate™	\$8.51 NET
50355	Instruction Sheet, Starter Fertilizer Pump Relay kit	\$8.51 NET
50360	Instruction Sheet, Trimble® Field-IQ™ Liquid & NH3 DirectConnect™	\$8.52 NET
50362	Instruction Sheet, 40A PWM EMD	\$8.51 NET
50368	Instruction Sheet, John Deere® GreenStar™ Liquid & NH3 DirectConnect™	\$8.51 NET
50371	System Manual, SafeGuard™ Console	\$8.51 NET
50374	Instruction Sheet, 8 GPM PWM Hydraulic Valve	\$8.51 NET
50375	Instruction Sheet, SafeGuard™ Demo Display	\$8.51 NET
50377	Instruction Sheet, NH3500™ Low Rate Conversion kit	\$8.51 NET
50380	Instruction Sheet, Shaft-Trak™ Low RPM	\$8.51 NET

\*NCNR

^One year warranty

## INDEX BY PART NUMBER

50382	Instruction Sheet, 15 GPM PWM Hydraulic Valve _____	\$8.51 NET
50383	Instruction Sheet, MC-10 w/Power Output _____	\$8.51 NET
50384 A	Instruction Sheet, 10A PWM EMD w/Enable _____	\$8.51 NET
50385	Instruction Sheet, 40A PWM EMD w/Enable _____	\$8.51 NET
50393	Instruction Sheet, Liquifier Jr. Upgrade kit _____	\$8.51 NET
50397	Instruction Sheet, ISOmod™ Power Switch Module kit _____	\$8.51 NET
50400	Instruction Sheet, ISOmod™ Magnet Mount kit _____	\$8.51 NET
50402	Instruction Sheet, Liquifier Max Vapor Fitting Install _____	\$8.51 NET
50404	Instruction Sheet, NH3 Servo Valve Gear Head Replacement _____	\$8.51 NET
50406 B	Instruction Sheet, SprayMate™ Plus to Raven 440 Adapter, w/CPC female connector _____	\$8.34 NET
50414 A	Instruction Sheet, SprayMate™ Plus™ to Raven 440 Adapter, w/CPC male (old style) _____	\$8.51 NET
50415 A	Instruction Sheet, Magnetic Flowmeter _____	\$8.51 NET
50421 A	Instruction Sheet, 25 GPM PWM Hydraulic Valve _____	\$8.52 NET



\*NCNR  
 ^One year warranty



800.328.9613

Toll-Free Sales and Service - U.S.A. and Canada

trakmail@micro-trak.com  
507.257.3600

www.micro-trak.com  
1305 Stadium Road  
Mankato, MN 56001-5355

102323

Copyright 2023 © Micro-Trak® Systems Inc. / All Rights Reserved