



## **2023–2024 US Dollar Price List Fluid Delivery Products**

## Product Group Codes

AA..... General Assembly  
 AAB ..... General Assembly – BSPT  
 AAP ..... General Assembly – BSPP  
 AB..... Repair Kit  
 AI3070..... Air Induction Dual Flat Spray Tips  
 AI ..... Air Induction Flat Spray Tips  
 AIC ..... Air Induction Flat Spray Tips  
 AITTJ ..... Air Induction Turbo TwinJet® Tips  
 AITX ..... Air Induction ConeJet® Hollow Cone Tips  
 AIUB..... Air Induction Underleaf Banding Tips  
 AIXR..... Air Induction XR TeeJet Tip  
 APTJ... AccuPulse® TwinJet® Tips  
 AX..... Orifice Insert for GunJet®  
 AY..... Orifice Insert for GunJet®  
 B ..... Item with BSPT Threads  
 CP..... Component Part  
 CPB..... Component Part with BSPT Threads  
 CPP..... Component Part with BSPP Threads  
 D ..... Orifice Disc  
 DC..... Disc Core  
 DDOC ..... DocJet Spray Tip  
 DE..... Orifice Disc, Stainless Steel  
 DG ..... Drift Guard® Flat Spray Tip  
 DGTJ ..... Drift Guard TwinJet® Flat Spray Tip  
 DOC..... DocJet Spray Tip  
 DX..... Orifice Tip for GunJet®  
 FL..... FullJet® Spray Tip  
 KLC..... FieldJet Boomless Nozzles  
 LI..... Literature, Promotional Items  
 OC ..... Off-Center Spray Tip  
 P ..... Item with BSPP Threads  
 PK..... Merchandising Card Pack Product  
 PW ..... High Pressure GunJet® Spray Guns  
 QCK ..... Quick Connect FloodJet® Spray Tip

QCTF ..... Quick Connect, Turbo FloodJet® Spray Tip  
 QJ ..... Quick TeeJet® System  
 QJB..... Quick TeeJet® w/ BSPT Threads  
 QJT..... Quick TeeJet® w/ TeeJet Threads  
 QJ90..... Turbo TeeJet Duo  
 SJ ..... StreamJet Fertilizer Spray Tips  
 T ..... Hollow Cone Spray Tip  
 TF ..... Turbo FloodJet® Flat Spray Tip  
 TFW ..... Extra Wide Turbo FloodJet Tip  
 TG..... Full Cone Spray Tip  
 TJ..... TwinJet Double Flat Spray Tip  
 TK..... FloodJet Flat Spray Tip  
 TKT..... FloodJet Flat Spray Tip  
 TP..... TeeJet® Spray Tips  
 TQ..... TeeJet® 150° Flat Spray Tip  
 TT ..... Turbo TeeJet® Flat Spray Tip  
 TTI ..... Turbo TeeJet® Induction Spray Tip  
 TTI60 ..... TTI TwinJet® Tip  
 TTJ ..... Turbo TwinJet Tips  
 1/4TTJ ..... TurfJet Flat Spray Tip  
 TX..... ConeJet® Hollow Cone Spray Tip  
 TY..... ConeJet® Hollow Cone Spray Tip  
 TZ..... ConeJet® Hollow Cone Spray Tip  
 VSM ..... Container Rinsing Nozzles  
 XE..... XE TeeJet® Extended Even Boomless Spray Tip  
 XP..... BoomJet® Boomless Nozzles  
 XR..... XR TeeJet® Extended Range Flat Spray Tip  
 XRC ..... XRC TeeJet Extended Range Flat Spray Tip









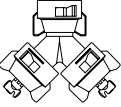

Wheaton, IL Facility

Prices effective September 1, 2023

All prices are EXW (Incoterms® 2010)  
 if shipped to Buyer within the United States,  
 and in all other circumstances DAP Buyer's  
 location (Incoterms® 2010) and are payable in U.S. Dollars



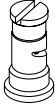

Prices are subject to change without notice and  
 are subject to freight, duty and local taxes.

TYPE (BROADCAST)		SIZE	ORIFICE INSERT/ TIP BODY MATERIAL	EXAMPLE TIP NO.	U.S. DOLLARS	
	<b>XR TeeJet<sup>®</sup></b> Extended Range Tips (Tapered Flat Fan Spray) <b>VisiFlo<sup>®</sup></b> Color-Coded	All Sizes	Stainless Steel	XR8010SS	\$ 12.38	
			Stainless Steel/Acetal	XR8001VS	10.44	
			Acetal (110° Only)	XR11002-VP	4.72	
			Ceramic/Polypropylene	XR11003-VK	8.08	
	<i>Tip with Quick TeeJet<sup>®</sup> cap and gasket assembly</i>	015 -02	Acetal (110° Only)	XR11002-VP-CE	6.53	
	<b>XRC TeeJet<sup>®</sup></b> Extended Range Tips (Tapered Flat Fan Spray) <b>VisiFlo<sup>®</sup></b> Color-Coded	All Sizes	Stainless Steel/Nylon	XRC8004-VS	11.99	
			Ceramic/Nylon	XRC11004-VK	9.77	
			Acetal/Nylon	XRC110025-VP	5.60	
	<b>Turbo TeeJet<sup>®</sup></b> Spray Tips (Tapered Flat Fan Spray) <b>VisiFlo<sup>®</sup></b> Color-Coded	01-08	Acetal	TT11001-VP	9.84	
		10-12	Acetal	TT11010-VP	11.80	
		<i>Tip with Quick TeeJet<sup>®</sup> cap and gasket assembly</i>	01-08	Acetal	TT11001-VP-CE	11.62
			10-12	Acetal	TT11010-VP-CE	14.54
	<b>Turbo TeeJet<sup>®</sup></b> Spray Tips (Tapered Flat Fan Spray) <b>VisiFlo<sup>®</sup></b> Color-Coded	015-08	Ceramic	TT11002-VK	14.34	
		<i>Tip with Quick TeeJet<sup>®</sup> cap and gasket assembly</i>	015-08	Ceramic	TT11002-VK-CE	16.11
	<b>AIXR TeeJet<sup>®</sup></b> Air Induction XR Flat Spray Tips (Tapered Flat Spray) <b>VisiFlo<sup>®</sup></b> Color-Coded	015-06	UHMWPE Polymer	AIXR11004VP	10.87	
		015-06	Ceramic/Polypropylene	AIXR11003VK	15.85	
		08-10	UHMWPE Polymer	AIXR11008VP	12.76	
		<i>Tip with Quick TeeJet<sup>®</sup> cap and gasket assembly</i>	015-06	UHMWPE Polymer	AIXR11003VP-CE	12.65
			015-06	Ceramic/Polypropylene	AIXR11005VK-CE	17.62
			08-10	UHMWPE Polymer	AIXR11010VP-CE	14.52
	<b>AI TeeJet<sup>®</sup></b> Air Induction Spray Tips (Tapered Flat Fan Spray) <b>VisiFlo<sup>®</sup></b> Color-Coded	All Sizes	Stainless Steel/Acetal	AI110015-VS	19.94	
	<b>AIC TeeJet<sup>®</sup></b> Air Induction Spray Tips (Tapered Flat Fan Spray) <b>VisiFlo<sup>®</sup></b> Color-Coded	All Sizes	Stainless Steel/Nylon	AIC11004-VS	21.62	
			Acetal/Nylon	AIC11004-VP	10.02	
			Ceramic/Nylon	AIC110025-VK	17.61	
	<b>Turbo TeeJet<sup>®</sup> Induction</b> Air Induction Spray Tips (Tapered Flat Fan Spray) <b>VisiFlo<sup>®</sup></b> Color-Coded	01-06	Acetal	TTI11004-VP	16.83	
		08-10	Acetal	TTI11008-VP	19.67	
		<i>Tip with Quick TeeJet<sup>®</sup> cap and gasket assembly</i>	01-06	Acetal	TTI11005-VP-CE	18.59
			08-10	Acetal	TTI11008-VP-CE	22.34
	<b>DG TeeJet<sup>®</sup></b> Drift Guard Tips (Tapered Flat Fan Spray) <b>VisiFlo<sup>®</sup></b> Color-Coded	All Sizes	Stainless Steel/Acetal	DG8002VS	14.44	
			Acetal	DG11002-VP	8.63	
	<b>TeeJet<sup>®</sup></b> Spray Tips (Tapered Flat Fan Spray) <b>VisiFlo<sup>®</sup></b> Color-Coded	All Sizes	Stainless Steel/Acetal	TP11001VS	9.34	
			Acetal	TP8002VP	1.38	
	<b>TeeJet<sup>®</sup></b> Spray Tips (Tapered Flat Fan Spray)	-0050 or Smaller	Brass	TP800050	6.29	
		Larger than -0050	Brass	TP800067	6.29	
		Smaller than -01	Stainless Steel	TP800067-SS	35.88	
			Stainless Steel	TP11001-SS	16.06	
-01 and Larger	Hardened Stainless Steel	TP11001-HSS	22.10			

	TYPE (BROADCAST)	SIZE	ORIFICE INSERT/ TIP BODY MATERIAL	EXAMPLE TIP NO.	U.S. DOLLARS
	<b>TwinJet</b> Spray Tips (Twin Tapered Flat Fan Spray) <b>VisiFlo</b> Color-Coded	All Sizes	Stainless Steel/Acetal	TJ60-8003VS	\$ 18.15
	<b>Turbo TeeJet Duo</b> Double Outlet QJ Adapter with 2 Turbo TeeJet® Tips (Twin Tapered Flat Fan Spray) <b>VisiFlo</b> Color-Coded	All Sizes	Acetal /Nylon	QJ90-2XTT11004-VP	29.20
	<b>Turbo TwinJet</b> Spray Tips (Twin Tapered Flat Fan Spray) <b>VisiFlo</b> Color-Coded	All Sizes	Acetal	TTJ60-11004VP	11.80
	Tip with Quick TeeJet® cap and gasket assembly	All Sizes	Acetal	TTJ60-11005VP-CE	13.58
	<b>AI Turbo TwinJet</b> (Twin Tapered Flat Fan Spray) <b>VisiFlo</b> Color-Coded	02-06	Acetal	AITTJ60-11004VP	12.24
		08-15	Acetal	AITTJ60-11008VP	14.08
	Tip with Quick TeeJet® cap and gasket assembly	02-06	Acetal	AITTJ60-11003VP-CE	14.22
		08-15	Acetal	AITTJ60-11015VP-CE	17.33
	<b>TTI60</b> TTI TwinJet® (Twin Tapered Flat Fan Spray)	02-08	Acetal	TTI60-11008VP	21.03
	<b>APTJ</b> AccuPulse® TwinJet® (Twin Tapered Flat Fan Spray)	All Sizes	Acetal	APTJ-11004VP	16.83
	Tip with Quick TeeJet® cap and gasket assembly		Acetal	APTJ-11003VP-CE	18.40
	Tip with Quick TeeJet® cap, gasket and Wilger adapter assembly		Acetal	APTJ-11005VP-CE-W	22.01
	<b>AI3070</b> Spray Tips (Dual Pattern Tapered Flat Fan Spray) <b>VisiFlo</b> Color-Coded	All Sizes	Acetal	AI3070-02VP	12.29
	Tip with Quick TeeJet® cap and gasket assembly	All Sizes	Acetal	AI3070-04VP-C	15.38
	<b>DG TwinJet</b> Drift Guard TwinJet Spray Tips (Twin Tapered Flat Fan Spray) <b>VisiFlo</b> Color-Coded	All Sizes	Stainless Steel/Acetal	DGTJ60-11004VS	22.13
	<b>Turbo FloodJet</b> Spray Tips (Wide Angle Flat Fan Spray) <b>VisiFlo</b> Color-Coded	All Sizes	Stainless Steel/Acetal	TF-VS4	19.72
			Acetal	TF-VP4	4.51
	<b>FloodJet</b> Spray Tips (Wide Angle Flat Fan Spray) <b>VisiFlo</b> Color-Coded	All Sizes	Brass	TK-3	10.27
		All Sizes	Stainless Steel	TK-SS3	18.68
		All Sizes	Stainless Steel/Acetal	TK-VS3	17.79

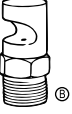

**SPRAY TIPS AND NOZZLES - BROADCAST**













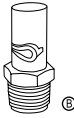

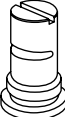

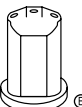
TYPE (BROADCAST)		SIZE	ORIFICE INSERT/ TIP BODY MATERIAL	EXAMPLE TIP NO.	U.S. DOLLARS
	<b>FloodJet</b> Spray Tips (Wide Angle Flat Fan Spray) <i>VisiFlo</i> Color-Coded	All Sizes	Acetal	TK-VP3	\$ 1.51
	<b>FloodJet</b> Nozzles (Wide Angle Tapered Flat Fan Spray)	See Example	Brass	1/8K-* 1/4K-* 3/8K-* 1/2K-* 3/4K-90 to 120 3/4K-140 to 210 1K-300 1K-450	7.92 12.45 19.76 27.79 45.55 84.00 157.19 183.92
			Stainless Steel	1/8K-SS 1/4K-SS 3/8K-SS 1/2K-SS 3/4K-SS80 to 120 3/4K-SS140 to 210 1K-SS300 1K-SS450	23.83 28.79 38.59 46.67 63.58 114.36 232.47 272.08
	<b>Quick Turbo FloodJet</b> Spray Nozzles (Wide Angle Tapered Flat Fan Spray) <i>VisiFlo</i> Color-Coded	All Sizes	Stainless Steel/Acetal	QCTF-VS15 to 80 QCTF-VS100 to 120	52.19 71.23
	<b>QCK Quick FloodJet</b> (Wide Angle Tapered Flat Fan Spray) <i>VisiFlo</i> Color-Coded	All Sizes	Stainless Steel/Acetal	QCK-SS20 to 40 QCK-SS50 to 80 QCK-SS100 & 120 QCK-SS150 to 210	56.12 61.36 76.55 120.99
	<b>TurfJet</b> Nozzles (Wide Angle Flat Fan Spray) <i>VisiFlo</i> Color-Coded	All Sizes	Stainless Steel/Acetal	1/4TTJ05-VS	25.55
			Acetal	1/4TTJ06-VP	13.22
	<b>FL FullJet</b> Spray Tips (Wide Angle Full Cone Spray) <i>VisiFlo</i> Color-Coded	All Sizes	Stainless Steel/Acetal	FL-5VS	17.77
			Acetal	FL-5VC	11.31

(B) Also available with BSPT connection

TYPE (BANDING & DIRECTED)		SIZE	ORIFICE INSERT/ TIP BODY MATERIAL	EXAMPLE TIP NO.	U.S. DOLLARS
	<b>AI TeeJet</b> Air Induction Even Spray Tips (Even Flat Fan Spray) <i>VisiFlo</i> Color-Coded	All Sizes	Stainless Steel/Acetal	AI95015EVS	\$ 20.41
	<b>DG TeeJet</b> Even Spray Tips (Even Flat Fan Spray) <i>VisiFlo</i> Color-Coded	All Sizes	Stainless Steel/Acetal	DG9504EVS	14.44
	<b>TeeJet</b> Spray Tips (Even Flat Fan Spray) <i>VisiFlo</i> Color-Coded	-01 And Larger	Brass	TP8001E	6.39
			Stainless Steel	TP8001E-SS	16.35
		-01 And Larger	Hardened Stainless Steel	TP8001E-HSS	22.47
			Stainless Steel/Acetal	TP8001EVS	9.34
	<b>TwinJet</b> Spray Tips (Twin Even Flat Fan Spray) <i>VisiFlo</i> Color-Coded	All Sizes	Stainless Steel/Acetal	TJ60-8003EVS	25.29
	<b>TeeJet</b> Spray Tips (Double Outlet Flat Fan Spray)	All Sizes	Brass	TQ150-01	13.63
			Stainless Steel	TQ150-01-SS	24.62
	<b>AIUB TeeJet</b> Air Induction (Underleaf Banding Spray Tips) <i>VisiFlo</i> Color-Coded	All Sizes	Stainless Steel/Acetal	AIUB8504VS	25.20
	<b>TeeJet</b> UB (Underleaf Banding Spray Tips)	All Sizes	Brass	D25143-UB-8504	22.16
			Stainless Steel	D25143-UB-8504-SS	42.15
	<b>TeeJet</b> OC Spray Tips (Off Center Flat Fan Spray)	-01 to -08, -12, -16	Brass	OC-02	16.67
			Stainless Steel	OC-SS02	24.62
	<b>TG FullJet</b> Spray Tips (Full Cone Spray)	Smaller than 1	Brass	TG-0.9	23.57
			Stainless Steel	TG-SS0.9	63.90
		1 and Larger	Brass	TG-1	13.58
			Stainless Steel	TG-SS1	29.92
	<b>TX ConeJet</b> Spray Tips (Hollow Cone Spray)	All Sizes	Brass	TX-1	8.81
			Stainless Steel	TX-SS1	55.14
	<b>TX, TXA, TXB ConeJet</b> (Hollow Cone Spray) <i>VisiFlo</i> Color-Coded	All Sizes	Ceramic/Polypropylene	TXA8004VK	8.92
				TXB8003VK	8.92
				TX-VK3	8.92
			Stainless Steel/Polypropylene	TX-VS4	9.85
	<b>TXR ConeJet</b> (Hollow Cone Spray) Color-Coded 100 Tip Pack	All Sizes	Ceramic/Polypropylene	TXR8002VK	8.70
		All Sizes	Ceramic/Polypropylene	TXR8003VK-100X	864.91
	<b>AITX ConeJet</b> Air Induction (Hollow Cone Spray) <i>VisiFlo</i> Color-Coded	All Sizes	Ceramic/Polypropylene	AITXA8001VK AITXB8004VK	19.94 19.94
	<b>TeeJet</b> Orifice Discs	All Sizes	Acetal	DVP-2	1.45
			Hardened Stainless Steel	D2	2.26
			Stainless Steel	DE2	2.04
			Ceramic	DCER-2	6.17
	<b>TeeJet</b> Cores	All Sizes	Nylon	DC23-NY	2.04
			Brass	DC23	3.90
			Hardened Stainless Steel	DC23-HSS	9.29
			Ceramic	DC25-CER	9.36



**SPRAY TIPS AND NOZZLES—BOOMLESS**

TYPE (BOOMLESS)		SIZE	ORIFICE INSERT/ TIP BODY MATERIAL	EXAMPLE TIP NO.	U.S. DOLLARS
	<b>BoomJet<sup>®</sup></b> Large Capacity Nozzles and Swivels (Boomless Flat Spray)	All Sizes	Brass	4418-3/4-2TOC 4629-3/4-TOC 5430-3/4-2TOC 5880-3/4-2TOC	\$ 331.50 255.87 343.23 387.56
	<b>TeeJet<sup>®</sup></b> OC Spray Tips (Large Capacity Off- Center Flat Spray Tips)	See Example	Brass	OC-20	69.39
			Stainless Steel	OC-SS20	134.94
	<b>XPBoomJet<sup>®</sup></b> Nozzles (Boomless Flat Spray) <b>VisiFlo<sup>®</sup></b> Color-Coded	¼" 10, 20, 25	Acetal	1/4XP25R-VP 1/4XP25L-VP	75.00 75.00
		½" 40 or 80	Acetal	1/2XP40R-VP 1/2XP40L-VP	89.33 89.33
	<b>FieldJet<sup>®</sup></b> Nozzles (Boomless Flat Spray)	All Sizes	Brass	1/4KLC 3/4KLC	63.17 88.27
			Stainless Steel	1/4KLC-SS18 3/4KLC-SS108	103.34 129.71
	<b>TFW Turbo FloodJet<sup>®</sup></b> Spray Tips (Extra Wide Angle Tapered Flat Fan Spray)	All Sizes	Brass	TFW-12	15.06
	<b>XE TeeJet<sup>®</sup></b> Spray Tips Extended Even Boomless Spray Tip	02-08	Acetal	XE15002-VP	6.07
TYPE (FERTILIZER)		SIZE	ORIFICE INSERT/ TIP BODY MATERIAL	EXAMPLE TIP NO.	U.S. DOLLARS
	<b>StreamJet<sup>®</sup></b> SJ7A Fertilizer Spray Tips (7 Orifices with Quick TeeJet <sup>®</sup> Connection) <b>VisiFlo<sup>®</sup></b> Color-Coded	All Sizes	Acetal	SJ7A-04-VP	\$16.98
	<b>StreamJet<sup>®</sup></b> SJ3 Fertilizer Spray Tips (3 Solid Stream Orifices) <b>VisiFlo<sup>®</sup></b> Color-Coded	All Sizes	Acetal	SJ3-04-VP	13.37
	<b>StreamJet<sup>®</sup></b> Fertilizer Nozzles (Solid Stream Nozzle)	0002-0080	Stainless Steel	H1/4U-SS0002	21.43
 SJ3-VR  SJ7A-VR  QJ-VR  PTC-VR  QJ-VR*	<b>StreamJet<sup>®</sup></b> Variable Rate Fertilizer Spray Tips (Solid Stream and Flow Regulators)	All	EPDM/Acetal or Nylon	SJ3-VR-X1.0 SJ7A-VR-X1.0 QJ-VR-X1.0 QJ-VR-X1.0-1/4-SS QJ-VR-X2.0-3/8-NYB PTC-VR-X1.0-1/4 PTC-VR-X1.0-1/4-10	34.03 37.65 34.53 55.94 41.43 40.13 57.62
 4908  CP4928  CP4916	<b>TeeJet<sup>®</sup></b> Flow Regulators (Orifice Regulating Plates and Components)	See Example	Brass	4908-1/4T	13.63
			Stainless Steel	4908-1/4T-SS CP4928-SS CP4916-28	60.09 52.68 4.72

(B) Also available with BSPT connection

# Quick TeeJet® CAPS (for pressures up to 300 PSI/20 bar)

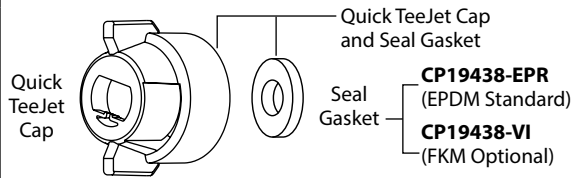

## Quick TeeJet Cap Color Code

BLACK.....	1
WHITE.....	2
RED.....	3
BLUE.....	4
GREEN.....	5
YELLOW.....	6

## Quick TeeJet Cap Color Code

BROWN.....	7
ORANGE.....	8
GRAY.....	9
VIOLET.....	10
LIGHT BLUE.....	11***
RASPBERRY RED...	12**
LIGHT GREEN.....	13**

\* Specify Color Code (see chart). Unless otherwise specified, a Black (1) Cap will be supplied.

† Gray option not offered on nylon or Hardi caps \*\*Color only offered in CP114501 Cap \*\*\* Color offered in CP114501, CP114440 & CP114442 Cap

	FOR USE WITH SPRAY TIPS (300 PSI/20 bar rating) >	PART NO.	U.S. DOLLARS
	<b>TeeJet® Flat Spray Tips (Smaller Capacities)</b>	Cap Only ..... CP114440A-*-CE	\$ 1.13
	Standard TP -0067 to -08	Cap and Seat Gasket Set (EPDM). 114441A-*-CELR	1.59
	APTJ TwinJet® -01 to -08	Cap and Seat Gasket Set (FKM) .. 114441A-*-CELVI	3.97
	XR -01 to -08	Cap Only ..... CP25611-9-PP>	1.43
	Turbo TwinJet® TTJ60	Cap and Seat Gasket Set. .... 25612-9-PP>	1.79
	AIXR TeeJet® -015 to -06	Cap Only ..... CP23307-*-CE	1.35
	DG TeeJet® -01 to -08	Cap and Seat Gasket Set. .... 23306H-*-CELR	1.85
	OC & TQ150 TeeJet®	Cap Only ..... CP25609-*-NY	1.30
	XR -10 to -15	Cap and Seat Gasket Set. .... 25610-*-NYR	1.79
	TJ TwinJet® TJ60	Cap Only ..... CP114442A-*-CE	1.30
	AI Turbo TwinJet® AITTJ60 -02 to -06	Cap and Seat Gasket Set (EPDM). 114443A-*-CELR	1.79
	DG TwinJet®	Cap and Seat Gasket Set (FKM) .. 114443A-*-CELVI	4.20
	S3J StreamJet	Cap Only ..... CP21399-*-CE	1.16
	AI TeeJet® & AIUB TeeJet®	Cap and Seat Gasket Set. .... 21398H-*-CELR	1.85
	Turbo TeeJet® Induction (TTI) straight through cap -015 to -06	Cap Only ..... CP115834A-*-CE >>>	1.30
		Cap and Seat Gasket Set (EPDM). 115835A-*-CELR >>>	1.79
		Cap and Seat Gasket Set (FKM) .. 115835A-*-CELVI >>>	4.20
	AI3070	Cap Only ..... CP98578-1-NY	2.13
	This cap has 0° offset for use with AI3070 tip only	Cap and Seat Gasket Set. .... 98579-1-NYR	2.95
	Turbo TeeJet® Induction TTI -08 to -10	Cap Only ..... CP114501A-*-CE >>	2.13
	AI Turbo TwinJet® AITTJ60 -08 to -15	Cap and Seat Gasket Set (EPDM). 114502A-*-CELR >>	2.95
	Turbo TeeJet® TT -10 to -12	Cap and Seat Gasket Set (FKM) .. 114502A-*-CELVI >>	5.36
	Turbo FloodJet®	Cap Only ..... CP25599-*-NY>>>>	1.30
	TK-VP FloodJet®	Cap and Seat Gasket Set. .... 25600-*-NYR	1.79
	TK-VS FloodJet®	Cap Only ..... CP114444A-*-CE	1.30
	TK FloodJet®	Cap and Seat Gasket Set(EPDM).. 114445A-*-CELR	1.79
	FL FullJet®	Cap and Seat Gasket Set(FKM) ... 114445A-*-CELVI	4.20
	TX ConeJet®	Cap Only ..... CP25607-9-PP >	1.43
	TG Full Cone	Cap and Seat Gasket Set. .... 25608-9-PP >	1.79
	Hose Shank	Cap Only ..... CP58350-*-CE	1.16
	AITXA	Cap and Seat Gasket Set. .... 58348H-*-CELR	1.85

> Polypropylene Caps rated to 150 psi (10 bar)  
 >> Only offered in -1, -2, -11, -12 & -13 colors  
 >>> Only offered in -1, -3, -4, -5, -6, -7, -9 & -10 colors  
 >>>> Offered in -1, -2, -3, -4, -5, -6, -7, -8 & -10 colors





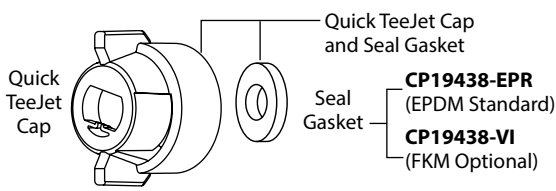



# Quick TeeJet® CAPS (for pressures up to 300 PSI/20 bar)

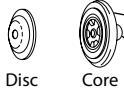

Quick TeeJet Cap Color Code		Quick TeeJet Cap Color Code	
BLACK .....	1	BROWN .....	7
WHITE .....	2	ORANGE .....	8
RED .....	3	GRAY .....	†9
BLUE .....	4	VIOLET .....	10
GREEN .....	5	LIGHT BLUE .....	11***
YELLOW .....	6	RASPBERRY RED ...	12**
		LIGHT GREEN .....	13**

\* Specify Color Code (see chart). Unless otherwise specified, a Black (1) Cap will be supplied.

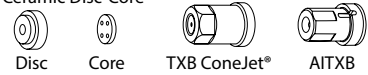
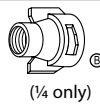
† Gray option not offered on nylon or Hardi caps \*\* Color only offered in CP114501 Cap \*\*\* Color offered in CP114501, CP114440 & CP114442 Cap

	FOR USE WITH SPRAY TIPS (300 PSI/20 bar rating)	PART NO.	U.S. DOLLARS
	 <p>Disc      Core</p> <p>Seal — CP18999-EPR Core Disc-Core (Insert Core into Seal)</p>	Cap Only ..... CP114444A-*-CE	\$ 1.30
	 <p>TXR ConeJet®</p>	Cap Only ..... CP114395-1-NYB Cap, Gasket and O-Ring Set ... 114396-1-NYR	1.30 2.13
	<p>Ceramic Disc-Core</p>  <p>Disc      Core      TXB ConeJet®      AITXB</p>	Cap Only ..... CP26277-1-NY Cap and Seat Gasket Set..... 26278-1-NYR	1.30 1.94
	Adapter Cap with EPDM Seat Gasket, Black	Quick TeeJet Outlet Adapter... QJ4676-1/8-NYR Quick TeeJet Outlet Adapter... QJ(B)4676-1/4-NYR	3.54 3.54
	Adapter Cap with EPDM Seat Gasket, Black	Quick TeeJet Outlet Adapter, 90°.. QJ4676-90-1/4-NYR Quick TeeJet Outlet Adapter, 45°.. QJ4676-45-1/4-NYR	6.70 6.70
	Shutoff Cap with EPDM/FKM Seat Gasket, Black	Cap and Seat Gasket Set (EPDM). 114447A-1-CELR Cap and Seat Gasket Set (FKM) .. 114447A-1-CELVI	3.38 5.79

# Quick TeeJet® NOZZLE BODY SYSTEMS FOR DRY BOOMS

**U.S.  
DOLLARS**

## QJS NOZZLE BODIES FOR DRY BOOMS

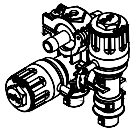

QJS-B2-\*-2-AA

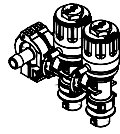

QJS-S2-\*-2-AA

QJS-B2-*-AA	-500, -750, -1000 Hose Shank, Bottom Mount, Dual Outlet Nozzle Body ...	\$ 146.26
QJS-B2-*-MM	-500, -750, -1000 Hose Shank, Bottom Mount, Dual Outlet Nozzle Body ...	54.22
QJS-B2-*-CM	-500, -750, -1000 Hose Shank, Bottom Mount, Dual Outlet Nozzle Body ...	45.20
QJS-B2-*-EM	-500, -750, -1000 Hose Shank, Bottom Mount, Dual Outlet Nozzle Body ...	323.27
QJS-S2-*-AA	-500, -750, -1000 Hose Shank, Side Mount, Dual Outlet Nozzle Body ...	148.38
QJS-S2-*-MM	-500, -750, -1000 Hose Shank, Side Mount, Dual Outlet Nozzle Body ...	56.35
QJS-S2-*-CM	-500, -750, -1000 Hose Shank, Side Mount, Dual Outlet Nozzle Body ...	47.32
QJS-S2-*-EM	-500, -750, -1000 Hose Shank, Side Mount, Dual Outlet Nozzle Body ...	325.39

Note: Hose I.D.: 500 = 1/2", 750 = 3/4", 1000 = 1"

## MULTIPLE NOZZLE BODIES WITH CHEMSAVER®

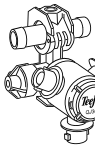

QJ363C  
QJ363E

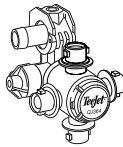

QJ364C  
QJ364E



QJ365C  
QJ365E

QJ363C-*-1-NYB	-500, -750, -1000 Nozzle Body with Single Hose Shank .....	29.09
QJ363C-*-2-NYB	-500, -750, -1000 Nozzle Body with Double Hose Shank .....	29.09
QJ364C-*-1-NYB	-500, -750, -1000 Nozzle Body with Single Hose Shank .....	29.09
QJ364C-*-2-NYB	-500, -750, -1000 Nozzle Body with Double Hose Shank .....	29.09
QJ365C-*-1-NYB	-500, -750, -1000 Nozzle Body with Single Hose Shank .....	29.09
QJ365C-*-2-NYB	-500, -750, -1000 Nozzle Body with Double Hose Shank .....	29.09
QJ363C-*-1-NYB-VI	-500, -750, -1000 Nozzle Body with Single Hose Shank .....	34.87
QJ363C-*-2-NYB-VI	-500, -750, -1000 Nozzle Body with Double Hose Shank .....	34.87
QJ364C-*-1-NYB-VI	-500, -750, -1000 Nozzle Body with Single Hose Shank .....	34.87
QJ364C-*-2-NYB-VI	-500, -750, -1000 Nozzle Body with Double Hose Shank .....	34.87
QJ365C-*-1-NYB-VI	-500, -750, -1000 Nozzle Body with Single Hose Shank .....	34.87
QJ365C-*-2-NYB-VI	-500, -750, -1000 Nozzle Body with Double Hose Shank .....	34.87

Note: Hose I.D.: 500 = 1/2", 750 = 3/4", 1000 = 1"

## MULTIPLE NOZZLE BODIES WITH FERTILIZER OUTLET AND CHEMSAVER



QJ363F

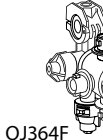

QJ364F

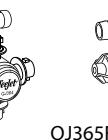

QJ365F

QJ363F-1000-*-NYB	Single or Double Hose Barb Nozzle Body .....	34.87
QJ364F-1000-*-NYB	Single or Double Hose Barb Nozzle Body .....	34.87
QJ365F-1000-*-NYB	Single or Double Hose Barb Nozzle Body .....	34.87
QJ363F-1000-*-NYB-VI	Single or Double Hose Barb Nozzle Body, FKM .....	41.86
QJ364F-1000-*-NYB-VI	Single or Double Hose Barb Nozzle Body, FKM .....	41.86
QJ365F-1000-*-NYB-VI	Single or Double Hose Barb Nozzle Body, FKM .....	41.86

## MULTIPLE NOZZLE BODIES FOR DRY BOOMS

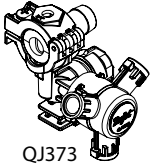

QJ373

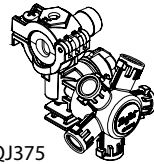

QJ375

QJ373-*-1-NYB	-500, -750, 1000 Nozzle Body with Single Hose Shank .....	19.68
QJ373-*-1R-NYB	-500, -750, 1000 Nozzle Body with Single Hose Shank .....	19.68
QJ373-*-2-NYB	-500, -750, 1000 Nozzle Body with Double Hose Shank .....	19.68
QJ375-*-1-NYB	-500, -750, 1000 Nozzle Body with Single Hose Shank .....	19.68
QJ375-*-1R-NYB	-500, -750, 1000 Nozzle Body with Single Hose Shank .....	19.68
QJ375-*-2-NYB	-500, -750, 1000 Nozzle Body with Double Hose Shank .....	19.68

Note: Hose I.D.: 500 = 1/2", 750 = 3/4", 1000 = 1"

## TRIPLE NOZZLE BODIES WITH CHEMSAVER



24230A-2

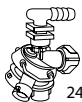

24230A-1

24230A-1-*-NYB	-406, -540, -785 Triple Nozzle Body with Single Hose Shank .....	32.02
24230A-2-*-NYB	-406, -540, -785 Triple Nozzle Body with Double Hose Shank .....	32.02
24230A-3-*-NYB	-406, -540, -785 Triple Nozzle Body with Triple Hose Shank .....	32.02

Note: Hose I.D.: 406 = 3/8", 540 = 1/2", 785 = 3/4"

## SINGLE NOZZLE BODIES WITH CHEMSAVER



19349



19350



19351



22251

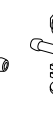

22252



QJ39685-1R



QJ39685-2



QJ39685-1L



QJ39685-3/8

19349-211-*-NYB	-406, -540, -785 Single Hose Shank Quick TeeJet Nozzle Body with Diaphragm Check Valve .....	14.91
19350-212-*-NYB	-406, -540, -785 Double Hose Shank Quick TeeJet Nozzle Body with Diaphragm Check Valve .....	14.91
19351-213-*-NYB	-406, -540, -785 Triple Hose Shank Quick TeeJet Nozzle Body with Diaphragm Check Valve .....	14.91
22251-311-*-NYB	-375, -500, -750 Single Hose Shank Quick TeeJet Nozzle Body with Diaphragm Check Valve .....	12.33
22252-312-*-NYB	-375, -500, -750 Double Hose Shank Quick TeeJet Nozzle Body with Diaphragm Check Valve .....	12.33
QJ39685-*-500-NYB	1/2" Hose ID, Quick TeeJet Nozzle Body with Diaphragm Check Valve .....	10.11
QJ39685-*-3/8-NYB	3/8", Push-to-Connect Inlet, Quick TeeJet Nozzle Body with Diaphragm Check Valve .....	20.85

Note: Hose I.D.: 375 & 406 = 3/8", 540 = 1/2", 750 & 785 = 3/4"

## HOSE SHANK NOZZLE BODIES



18635

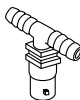

18636

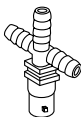







18637

18635-111-406-NYB	Single Hose Shank Quick TeeJet Nozzle Body .....	6.05
18638-111-540-NYB	Single Hose Shank Quick TeeJet Nozzle Body .....	6.05
18719-111-785-NYB	Single Hose Shank Quick TeeJet Nozzle Body .....	6.05
18636-112-406-NYB	Double Hose Shank Quick TeeJet Nozzle Body .....	6.05
18639-112-540-NYB	Double Hose Shank Quick TeeJet Nozzle Body .....	6.05
18720-112-785-NYB	Double Hose Shank Quick TeeJet Nozzle Body .....	6.05
18637-113-406-NYB	Triple Hose Shank Quick TeeJet Nozzle Body .....	6.05
18640-113-540-NYB	Triple Hose Shank Quick TeeJet Nozzle Body .....	6.05
18721-113-785-NYB	Triple Hose Shank Quick TeeJet Nozzle Body .....	6.05

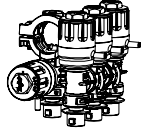
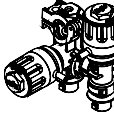
Note: Hose I.D.: 406 = 3/8", 540 = 1/2", 785 = 3/4"

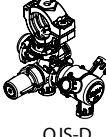
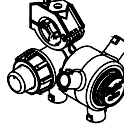
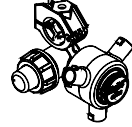
# Quick TeeJet® NOZZLE BODY SYSTEMS FOR WET BOOMS

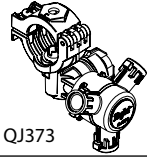
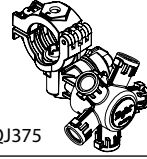
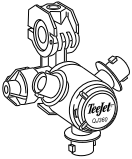
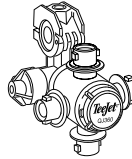
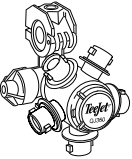
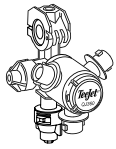
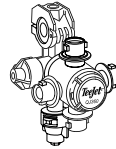
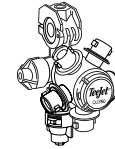
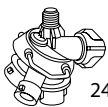
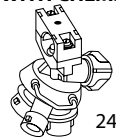
**U.S.  
DOLLARS**

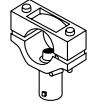
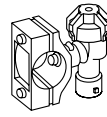
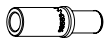







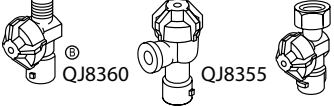
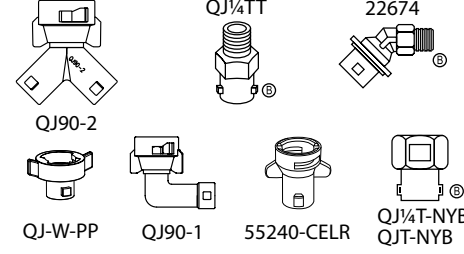
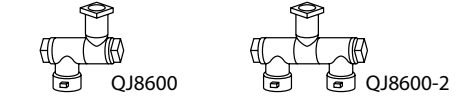
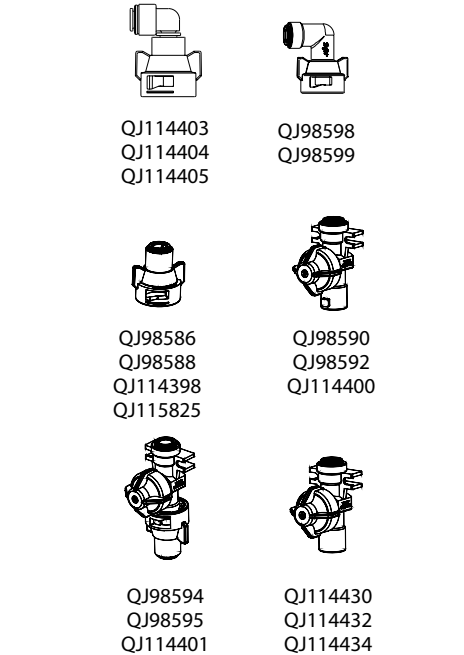

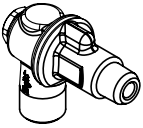
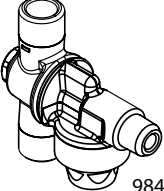
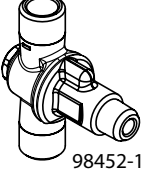
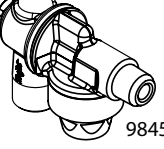

QJS NOZZLE BODIES FOR WET BOOMS				
   QJS-S2-AA      QJS-H4-AAAA      QJS-B2-AA   QJS-Y      QJS-D		QJS-B2-*-AA -20mm, -1/2", -3/4" -1" Bottom Mount, Dual Outlet Nozzle Body. . . . . QJS-B2-*-MM -20mm, -1/2", -3/4" -1" Bottom Mount, Dual Outlet Nozzle Body. . . . . QJS-B2-*-CM -20mm, -1/2", -3/4" -1" Bottom Mount, Dual Outlet Nozzle Body. . . . . QJS-S2-*-EM -20mm, -1/2", -3/4" -1" Bottom Mount, Dual Outlet Nozzle Body. . . . . QJS-S2-*-AA -20mm, -1/2", -3/4" -1" Side Mount, Dual Outlet Nozzle Body. . . . . QJS-S2-*-MM -20mm, -1/2", -3/4" -1" Side Mount, Dual Outlet Nozzle Body. . . . . QJS-S2-*-CM -20mm, -1/2", -3/4" -1" Side Mount, Dual Outlet Nozzle Body. . . . . QJS-S2-*-EM -20mm, -1/2", -3/4" -1" Side Mount, Dual Outlet Nozzle Body. . . . . QJS-F1-*-C -20mm, -1/2", -3/4", -1" Bottom Mount, Flow Meter, Nozzle Body . . . . . QJS-H4R-*-AAAA -20mm, -1/2", -3/4", -1" Bottom Mnt, High Strength, 4 Outlet . . . . . QJS-N3-*-EMM Btm Mnt, Flow Meter, High Str, 3 Outlet . . . . . QJS-D *-XM-3-P -20mm, -1/2", -3/4", -1" Bottom Mount with Turret Nozzle Body . . . . .	\$ 146.26 54.22 45.20 323.27 148.38 56.35 47.32 325.39 172.82 309.49 353.85 60.52	
<b>HIGH FLOW MULTIPLE NOZZLE BODIES</b>    QJ383F      QJ383      CP98488-VI		QJ383-*-NYB -3/4", -1" Split Eyelet High Flow Nozzle Body, FKM. . . . . QJ383F-*-NYB -3/4", -1" Split Eyelet High Flow Nozzle Body with Fertilizer Outlet, FKM . . . . . CP98488-VI 1/16" to 3/8" Inlet Adapter Gasket . . . . .	46.08 50.30 9.85	
<b>MULTIPLE NOZZLE BODIES FOR WET BOOMS</b>   QJ373      QJ375		QJ373-*-NYB -20mm, -25mm, -1/2, -3/4, -1 Split Eyelet Nozzle Body . . . . . QJ375-*-NYB -20mm, -25mm, -1/2, -3/4, -1 Split Eyelet Nozzle Body . . . . .	14.65 14.65	
<b>MULTIPLE NOZZLE BODIES WITH CHEMSAVER®</b>    QJ363C      QJ364C      QJ365C QJ363E      QJ364E      QJ365E		QJ363C-*-NYB -25 mm, -1/2", -1/2" x 7 mm, -3/4" -1" Split Eyelet Diaphragm Check Valve. . . . . QJ363E-*-NYB -20 mm Split Eyelet Diaphragm Check Valve . . . . . QJ364C-*-NYB -25 mm, -1/2", -1/2" x 7 mm, -3/4" -1" Split Eyelet Diaphragm Check Valve. . . . . QJ364E-*-NYB -20 mm Split Eyelet Diaphragm Check Valve . . . . . QJ365C-*-NYB -25 mm, -1/2", -1/2" x 7 mm, -3/4" -1" Split Eyelet Diaphragm Check Valve. . . . . QJ365E-*-NYB -20 mm Split Eyelet Diaphragm Check Valve . . . . . QJ363C-*-NYB-VI -25 mm, -1/2", -1/2" x 7 mm, -3/4" -1" Split Eyelet Diaphragm Check Valve, FKM . . . . . QJ363E-*-NYB-VI -20 mm Split Eyelet Diaphragm Check Valve, FKM . . . . . QJ364C-*-NYB-VI -25 mm, -1/2", -1/2" x 7 mm, -3/4" -1" Split Eyelet Diaphragm Check Valve, FKM. . . . . QJ364E-*-NYB-VI -20 mm Split Eyelet Diaphragm Check Valve, FKM . . . . . QJ365C-*-NYB-VI -25 mm, -1/2", -1/2" x 7 mm, -3/4" -1" Split Eyelet Diaphragm Check Valve, FKM. . . . . QJ365E-*-NYB-VI -20 mm Split Eyelet Diaphragm Check Valve, FKM . . . . .	23.30 23.30 23.30 23.30 23.30 23.30 26.84 26.84 26.84 26.84 26.84 26.84 26.84	
<b>MULTIPLE NOZZLE BODIES WITH FERTILIZER OUTLET AND CHEMSAVER</b>    QJ363F      QJ364F      QJ365F		QJ363F-1-NYB 1" Split Eyelet Diaphragm Check Valve . . . . . QJ364F-1-NYB 1" Split Eyelet Diaphragm Check Valve . . . . . QJ365F-1-NYB 1" Split Eyelet Diaphragm Check Valve . . . . . QJ363F-1-NYB-VI 1" Split Eyelet Diaphragm Check Valve, FKM. . . . . QJ364F-1-NYB-VI 1" Split Eyelet Diaphragm Check Valve, FKM. . . . . QJ365F-1-NYB-VI 1" Split Eyelet Diaphragm Check Valve, FKM. . . . .	29.07 29.07 29.07 35.50 35.50 35.50	
<b>TRIPLE NOZZLE BODIES WITH CHEMSAVER</b>   24231A      24216A		24216A-*-NYB -20 mm, -20 mm x 7, -1/2", -1/2" x 7, -3/4" -1" TeeJet Triple Nozzle Body . . . . . 24231A-NYB TeeJet Triple Nozzle Body with 1/4" Inlet. . . . .	17.55 32.90	
<b>SINGLE NOZZLE BODIES WITH CHEMSAVER</b>    QJ17560A      †QJ7241      QJ22187		QJ17560A-*-NYB -25 mm, -20 mm, -20 mm x 7 mm, -1/2", -1/2" x 7 mm, -3/4", -1" Quick TeeJet Split Eyelet with ChemSaver . . . . . QJ17560A-*-NYB-VI -25 mm, -20 mm, -20 mm x 7 mm, -1/2", -1/2" x 7 mm, -3/4", -1" Quick TeeJet Split Eyelet with ChemSaver, FKM . . . . . †QJ7421-*-NYB -1/2", -3/4", -1" Quick TeeJet Split Eyelet, less ChemSaver. . . . . QJ22187-*-NYB -1/2", -3/4", -1" Quick TeeJet Split Eyelet, less ChemSaver. . . . . † Does Not Include ChemSaver	4.58 5.34 6.07 15.24	
<b>RAPID STOP NOZZLE BODY ADAPTER</b>  CP98583		CP98583-2-*-SS Rapid Stop for QJ17560A & 24216A. . . . . CP98583-3-*-SS Rapid Stop for QJ360C, QJ360F, QJ370, QJ380, QJ380F & QJS . . . . .	12.97 12.97	

\* - Specify pipe size (1/2", 3/4", or 1")

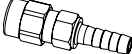
# Quick TeeJet® ADAPTERS

U.S.  
DOLLARS

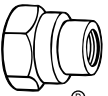
<p><b>BLANK SPLIT EYELET FOR WET BOOM</b></p>  <p>QJS-P-1</p>	<p>QJS-P-1      QJS Blank for 1" Wet Boom .....</p>	<p>\$ 6.35</p>
<p><b>SINGLE NOZZLE BODY ADAPTERS WITH CHEMSAVER®</b></p>  <p>QJ8360      QJ8355      QJT8360 QJP19011 QJ8360-1/4F-NYB</p>	<p>QJ8360-NYB      ¼" (M) Diaphragm Check Valve Quick TeeJet Nozzle Body ..... QJ8360-1/4F-NYB      ¼" (F) Diaphragm Check Valve Quick TeeJet Nozzle Body ..... QJ8355-*-NYB      ⅜", ¼" (F) Diaphragm Check Valve Quick TeeJet Nozzle Body.... QJT8360-NYB      Quick TeeJet Adapter, fits TeeJet Bodies using CP1325 Cap ..... QJP19011-NYB      Quick TeeJet Adapter, fits ⅜" BSPP (M) Thread .....</p>	<p>7.53 8.20 15.11 8.20 9.94</p>
<p><b>NOZZLE BODY ADAPTERS</b></p>  <p>QJ90-2      QJ¼TT      22674 QJ-W-PP      QJ90-1      55240-CELR      QJ¼T-NYB QJT-NYB</p>	<p>QJ90-2-NYR      Quick TeeJet Duo Nozzle Adapter with EPDM Gasket ..... QJ90-1-NYR      90° Quick TeeJet Adapter with EPDM Gasket ..... QJ1/4TT-NYB      Quick TeeJet Nozzle Body Adapter ..... QJ1/4T-NYB      Quick TeeJet Nozzle Body Adapter ..... QJT-NYB      Quick TeeJet Nozzle Body Adapter ..... 22674-1/4-NYB      Quick TeeJet 45° Nozzle Body Adapter ..... 55240-CELR      Hardi Quick TeeJet Adapter with EPDM Gasket ..... 50854-NYB      Quick TeeJet Nozzle Body 1" (25 mm) Extension ..... QJ-W-PP      Wilger to Quick TeeJet Adapter with EPDM Gasket ..... QJ-W-PP-10X      Wilger to Quick TeeJet Adapter with EPDM Gasket 10 Pk .....</p>	<p>6.70 6.70 4.14 4.14 7.67 4.14 4.14 5.83 4.22 41.24</p>
<p><b>SWIVELS</b></p>  <p>QJ8600      QJ8600-2</p>	<p>QJ8600-1/4-NYB      Quick TeeJet Single Swivel ..... QJ8600-2-1/4-NYB      Quick TeeJet Double Swivel .....</p>	<p>11.00 13.24</p>
<p><b>PUSH-TO-CONNECT FITTINGS</b></p>  <p>QJ114403      QJ98598 QJ114404      QJ98599 QJ114405 QJ98586      QJ98590 QJ98588      QJ98592 QJ114398      QJ114400 QJ115825 QJ98594      QJ114430 QJ98595      QJ114432 QJ114401      QJ114434</p>	<p>QJ98595-1/4-*      ¼" Push-to-Connect Straight Cap &amp; Body ..... QJ114401-5/16-*      ⅜" Push-to-Connect Straight Cap &amp; Body ..... QJ98594-3/8-*      ⅜" Push-to-Connect Straight Cap &amp; Body ..... QJ98592-1/4-*      ¼" Push-to-Connect Body ..... QJ114400-5/16-*      ⅜" Push-to-Connect Body ..... QJ98590-3/8-*      ⅜" Push-to-Connect Body ..... QJ98588-1/4      ¼" Push-to-Connect Straight Cap ..... QJ114398-5/16      ⅜" Push-to-Connect Straight Cap ..... QJ115825-3/16      ⅜" Push-to-Connect Straight Cap ..... QJ98586-3/8      ⅜" Push-to-Connect Straight Cap ..... QJ98598-90-1/4      ¼" Push-to-Connect 90° Fixed Cap ..... QJ98599-90-3/8      ⅜" Push-to-Connect 90° Fixed Cap ..... QJ114403-1/4      ¼" Push-to-Connect 90° Swivel Cap ..... QJ114404-5/16      ⅜" Push-to-Connect 90° Swivel Cap ..... QJ114405-3/8      ⅜" Push-to-Connect 90° Swivel Cap ..... QJ114430-1/4-*      ¼" Push-to-Connect Capless Body, PTC In &amp; PTC Out ..... QJ114432-5/16-*      ⅜" Push-to-Connect Capless Body, PTC In &amp; PTC Out ..... QJ114434-3/8-*      ⅜" Push-to-Connect Capless Body, PTC In &amp; PTC Out .....</p> <p><i>*Specify diaphragm check valve opening pressure (2, 5 or 10 psi)</i></p>	<p>25.97 25.97 25.97 17.55 17.55 17.55 8.47 8.47 8.47 8.47 10.57 10.57 21.14 21.14 21.14 24.34 24.34 24.34</p>

				U.S. DOLLARS
<b>ROLLOVERS</b>				
	98453-1/4M	(B)98450-1/4F	Double Rollover with Diaphragm Check .....	\$ 61.39
	98450-1/4M	(B, S, P)98450-1/4M	Double Rollover with Diaphragm Check .....	61.39
	98452-1/4M	(B, S, P)98450-3/8M	Double Rollover with Diaphragm Check .....	61.39
	98451-1/4M	(B)98451-1/4F	Single Rollover with Diaphragm Check .....	56.98
		(B, S, P)98451-1/4M	Single Rollover with Diaphragm Check .....	56.98
		(B, S, P)98451-3/8M	Single Rollover with Diaphragm Check .....	56.98
		(B)98452-1/4F	Double Rollover.....	48.23
		(B, S, P)98452-1/4M	Double Rollover.....	48.23
		(B, S, P)98452-3/8M	Double Rollover.....	48.23
		(B)98453-1/4F	Single Rollover.....	43.84
		(B, S, P)98453-1/4M	Single Rollover.....	43.84
		(B, S, P)98453-3/8M	Single Rollover.....	43.84
		AB98450-KIT	Rollover Spare Parts Kit (See PL98450 for details) .....	14.66
		<i>Note: B = BSPT thread, S = NPS thread, P = BSPP thread, no letter = NPT thread</i>		
<b>TEEJET TIP STRAINERS</b>				
	Strainer 5053 6051 8079	5053-*SS	Brass with Stainless Steel Screen.....	4.29
	4514 Slotted Strainer	6051-SS-*	Stainless Steel throughout .....	16.82
	4067 Cup Strainer	8079-PP-*	Polypropylene with Stainless Steel Screen .....	1.82
		5054-*SS	Extra-long, Brass with Stainless Steel Screen .....	14.71
		4067-SS-*	Cup Strainer, Stainless Steel .....	2.37
		4514-*	Slotted Strainer, Brass .....	2.04
		4514-NY-*	Slotted Strainer, Nylon .....	1.93
		9106	Fused Bronze Filter .....	4.61
<b>TEEJET CHECK VALVES</b>				
	4193B Strainer- Check Valve	4193B-*SS	Brass with Stainless Steel Screen.....	7.50
	11750 Check Valve	4193B-SS-*SS	Stainless Steel throughout .....	29.45
	39188	4193B-PP-*SS	Polypropylene with Stainless Steel Screen and FKM Ball....	5.96
		4193B-PP-*SS-*SS	Polypropylene with Stainless Steel Screen and Ball .....	10.40
		11750-*	Brass .....	9.90
		11750-SS-*	Stainless Steel .....	31.55
		11750-PP-*	Polypropylene .....	8.42
		39188-8400-406-SS	Hose Shank Check Valve, Stainless Steel.....	51.19
		39188-8400-540-SS	Hose Shank Check Valve, Stainless Steel.....	55.95
<b>TEEJET HOSE SHANKS</b>				
	4251 8400	4251-250, etc.	Brass .....	4.84
	8400-T-406	4251-250-SS, etc.	Stainless Steel .....	9.95
		8400-406,-500-NYB	Nylon.....	1.60
		8400-T-406-NYB	Nylon.....	3.50
		<i>Note: Hose I.D.: 250 = 1/4", 406 = 3/8", 500 = 1/2"</i>		
<b>TEEJET CAPS</b>				
	CP1325 CP8027	CP1325	Brass .....	2.08
	CP18032A	CP1325-SS	Stainless Steel .....	12.19
		CP8027-NYB	Nylon.....	1.40
		CP8027-1-NYB	Extra-long, Nylon .....	1.78
		CP18032A-NYB	Winged TeeJet Cap, Nylon.....	1.93
		CP20230	Brass, for use with Ceramic Discs and Cores .....	2.46
		CP3819	Brass, for use with 3/4T and 3/4TT Bodies .....	16.05
		CP3819-SS	Stainless Steel, for use with 3/4T and 3/4TT Bodies .....	45.47
<b>TEEJET ADAPTERS</b>				
	4676	4676-1/2	Brass .....	12.99
	CP6250	4676-1/8, -1/4, -3/8	Brass .....	4.24
	6406	4676-3/4	Brass .....	17.85
		4676-ENP-1/8, -1/4, -3/8	Brass, Nickel-plated .....	4.81
		4676-SS-1/8, -1/4	Stainless Steel .....	14.26
		4676-NYB-1/8, -1/4	Nylon.....	3.49
		CP6250	Brass .....	6.73
		CP6250-I	Steel.....	7.71
		6406	Brass, 1/8 Adapter.....	7.13
		6406-I	Steel, 1/8 Adapter.....	10.06

\*- Specify mesh size and/or opening pressure in PSI

(B) Also available with BSPT connection

**HOSE SHANK CONNECTORS**

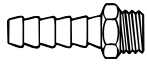

6053  
6100  
8400  
10123

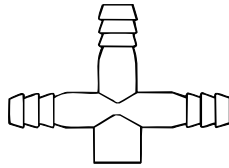

13436  
13439

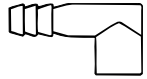

13434  
13437

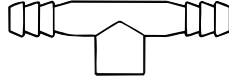

13435  
13438

6053-400, -535	Brass .....	\$ 6.50
6100-500, -675, -800	Brass .....	12.77
10123-1/4-281	Brass .....	7.06
8400-1/4-300, -406, -535-NYB	Nylon.....	1.92
8400-3/8-406, -535-NYB	Nylon.....	2.50
8400-1/2-406, -535, -660-NYB	Nylon.....	3.26
8400-3/4-535, -660, -785-NYB	Nylon.....	3.50
8400-T-406	Nylon.....	3.50
13434-406-NYB	Nylon.....	6.60
13435-406-NYB	Nylon.....	6.60
13436-406-NYB	Nylon.....	6.60
13437-540-NYB	Nylon.....	6.60
13438-540-NYB	Nylon.....	6.60
13439-540-NYB	Nylon.....	6.60

Note: Hose I.D.: 300 = 1/4", 400 & 406 = 3/8", 500 & 535 = 1/2", 660 = 5/8", 785 = 3/4"

**PIPE PLUGS**



8400

8400-1/4-PPB	Polypropylene .....	2.26
8400-1/2-NYB	Nylon.....	3.00
8400-3/4-NYB	Nylon.....	3.43

**HOSE DROPS**

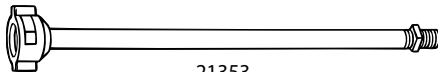

21353

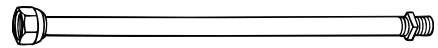

21354

21353-6-15-NYB	Quick TeeJet Hose Drop, EPDM Gasket, 15"/38 cm .....	17.84
21353-6-24-NYB	Quick TeeJet Hose Drop, EPDM Gasket, 24"/61 cm .....	17.84
21354-15-NYB	TeeJet Hose Drop, Nylon throughout, 15"/38 cm .....	11.80
21354-24-NYB	TeeJet Hose Drop, Nylon throughout, 24"/61 cm .....	13.14

**SINGLE SWIVEL TEEJET NOZZLE BODY ASSEMBLIES**

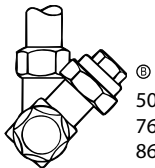

5000  
7620  
8600

5000-1/8T, -1/4T	Brass .....	26.57
5540-1/4TT	Brass .....	29.36
7620-T	Brass .....	38.88
8600-1/4T-NYB	Nylon.....	12.76

**DOUBLE SWIVEL TEEJET NOZZLE BODY ASSEMBLIES**

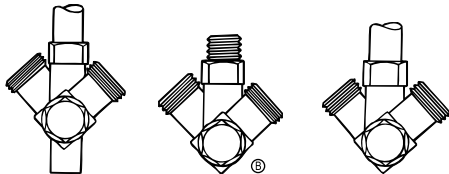

5932

6240

8600-2

6240-1/4TT	Brass .....	28.77
5932-2-1/4T	Brass .....	51.83
8600-2-1/4T-NYB	Nylon.....	15.39

**VARI-SPACING TEEJET CLAMP ASSEMBLIES**



AA111

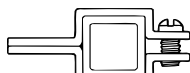

AA111-SQ

AA111-1/2, -3/4, -1	Clamp Sub-assembly.....	6.83
AA111-1-1/4	Clamp Sub-assembly.....	11.41
AA111SQ-1	Clamp Sub-assembly.....	7.84
AA111SQ-1-1/4	Clamp Sub-assembly.....	11.79
AA111SQ-1-1/2	Clamp Sub-assembly.....	14.01

**TEEJET HOSE SHANK BODY ASSEMBLIES**

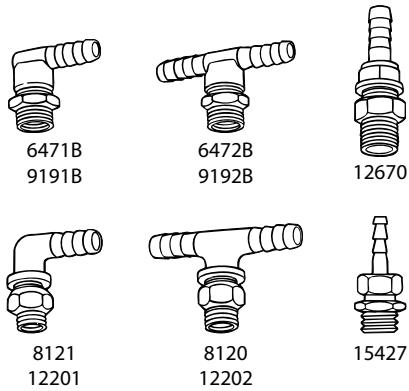

6471B-400TD	TeeJet Nozzle Body Assembly, Brass .....	\$ 18.90
6471-SS-C400TD	TeeJet Nozzle Body Assembly, Stainless Steel .....	169.04
6472B-400TD	TeeJet Nozzle Body Assembly, Brass .....	18.90
6472-SS-C400TD	TeeJet Nozzle Body Assembly, Stainless Steel .....	163.35
8120-NYB-540TD, -406TD	TeeJet Nozzle Body Assembly, Nylon .....	4.72
8121-NYB-540TD, -406TD	TeeJet Nozzle Body Assembly, Nylon .....	4.72
8124-NYB-406TD, -540TD	TeeJet Nozzle Body Assembly, Nylon .....	4.72
9191B-531TD	TeeJet Nozzle Body Assembly, Brass .....	18.90
9191-SS-C531TD	TeeJet Nozzle Body Assembly, Stainless Steel .....	196.70
9192B-531TD	TeeJet Nozzle Body Assembly, Brass .....	18.90
9192-SS-C531TD	TeeJet Nozzle Body Assembly, Stainless Steel .....	196.70
12201-CE-785TD, -1062TD	TeeJet Nozzle Body Assembly, Acetal .....	20.27
12202-CE-785TD, -1062TD	TeeJet Nozzle Body Assembly, Acetal .....	20.27
12670-406TD-NYB	TeeJet Nozzle Body Assembly, Nylon .....	9.82
12670-406TD-SS	TeeJet Nozzle Body Assembly, Stainless Steel .....	76.98
15427-1-296	TeeJet Nozzle Body Assembly, Brass .....	13.51

*Note: Hose I.D.: 296 = 1/4", 406 = 3/8", 540 = 1/2", 531 = 1/2", 785 = 3/4", 1062 = 1"*

**TEEJET SPLIT-EYELET BODY ASSEMBLIES**

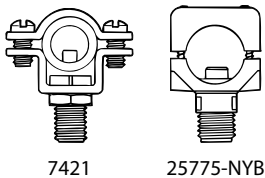

25775-1/2T-NYB, -3/4T-NYB, -1T-NYB	With Nylon Clamp and Body .....	8.24
7421-1/2T, -3/4T, -1T	With Brass Body .....	10.70
7421-1/2T-SS, -3/4T-SS, -1T-SS	With Stainless Steel Body .....	18.92
7421SS-1/2T-SS, -3/4T-SS, -1T-SS	With Stainless Steel throughout .....	31.53
7421-1/2T-NYB, -3/4T-NYB, -1T-NYB	With Nylon Body .....	5.86
7421-3/4TD	With Brass Body .....	14.80
7421-1/2TD-SS, -3/4TD-SS	With Stainless Steel Body .....	27.35

**SPLIT-EYELET CONNECTORS**

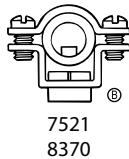

7521A-1/2x1/8, etc.	With Brass Body .....	12.82
7521C-1/2x1/8, etc.	With Stainless Steel Body .....	19.22
7521B-1/2x1/8, etc.	Stainless Steel throughout .....	32.11
8370A-1-1/4x	With Brass Body .....	22.22
8370A-1-1/2x	With Brass Body .....	28.25
8370A-2x	With Brass Body .....	33.18
8370B-1-1/4x	Stainless Steel throughout .....	52.88
8370B-1-1/2x	Stainless Steel throughout .....	62.27
8370B-2x	Stainless Steel throughout .....	66.92
8370C-1-1/4x	With Stainless Steel Body .....	41.67
8370C-1-1/2x	With Stainless Steel Body .....	48.33
8370C-2x	With Stainless Steel Body .....	52.88

**TEEJET NOZZLE BODIES WITH CHEMSAVER<sup>®</sup>**

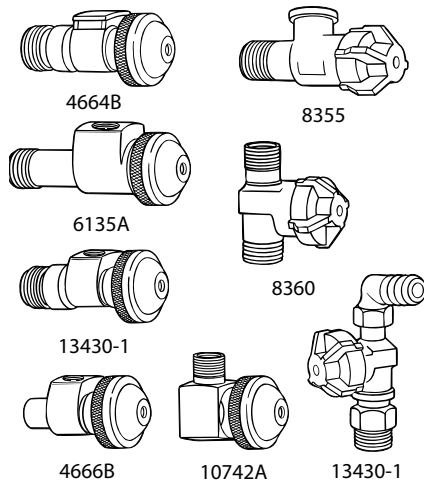

4664B	Diaphragm Check Valve, Brass .....	42.99
6135A-1/4, -3/8	Diaphragm Check Valve, Brass .....	64.12
8355-1/8-NYB, -1/4-NYB	Diaphragm Check Valve, Nylon .....	15.53
8360-NYB	Diaphragm Check Valve, Nylon .....	26.17
13430-1-NYB, -2-NYB, -3-NYB	Diaphragm Check Valve, Nylon .....	31.89
13431-NYB	Diaphragm Check Valve, Nylon .....	25.53
4666B	Brass .....	42.99
6140A-1/4, -3/8	Brass .....	76.23
10742A	Brass .....	56.88
12328-1/2-NYB, -3/4-NYB	Nylon .....	130.44

# TeeJet<sup>®</sup> TECHNOLOGIES

## BOOM COMPONENTS

**U.S.  
DOLLARS**

### VARI-SPACING CLAMPS

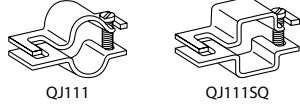

QJ111-1/2, -3/4, -1, or -1-1/4	Vari-Spacing Quick TeeJet Clamp .....	\$ 4.01
QJ111SQ-3/4, -1, -1-1/4, -1-1/2	Vari-Spacing Quick TeeJet Clamp .....	4.01
QJ111SQ-304SS	Stainless (Same sizes as QJ111SQ above) .....	8.80
QJ111HP-3/4	¾" High Profile QJ Clamp .....	15.36

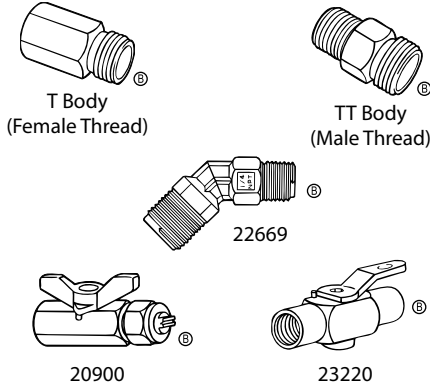

CP1335	1/8T, Brass .....	3.40
CP1336	1/8TT, Brass .....	3.40
CP1321	¼T, Brass .....	3.40
CP1321-SS	¼T-SS, Stainless Steel .....	22.35
CP12094-NYB	¼T-NY, Nylon .....	2.37
CP1322	¼TT, Brass .....	3.40
CP1322-SS	¼TT-SS, Stainless Steel .....	22.35
CP8028-NYB	¼TT-NY, Nylon .....	2.43
CP8108	¼TT, Extra-long, Brass .....	11.82
CP1323	¾T, Brass .....	5.83
CP1324	¾TT, Brass .....	3.40
CP1339	½T, Brass .....	12.32
CP1340	½TT, Brass .....	12.32
CP3817	¾T, Brass .....	27.54
CP3817-SS	¾T, Stainless Steel .....	78.67
CP3818	¾TT, Brass .....	27.54
CP3818-SS	¾TT, Stainless Steel .....	78.67
22669-1/4-PPB	45° Nozzle Body .....	2.66
23220-*	Plug Valve .....	32.84
20900-*	Ball Valve, Brass .....	86.80

# TeeJet<sup>®</sup> TECHNOLOGIES

## BOOM COMPONENTS

**U.S.  
DOLLARS**

### TEEJET CHEMSAVER<sup>®</sup> COMPONENTS

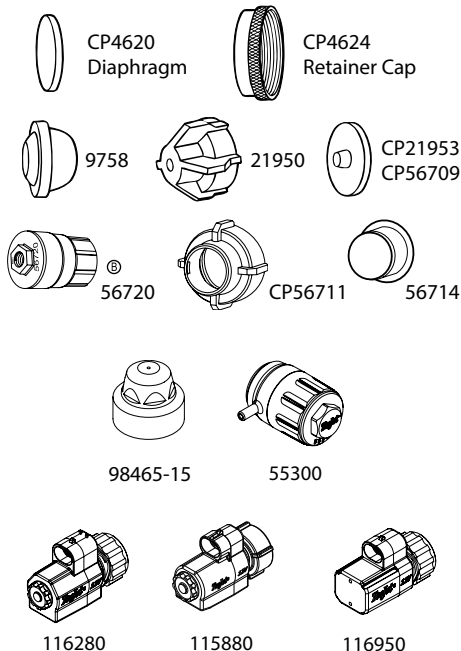

CP4620-VI	Diaphragm, FKM .....	\$ 2.30
CP4620-FA	Diaphragm, Fairprene .....	0.73
CP6227-TEF	Diaphragm, PTFE (use with 4620) .....	1.17
CP21953-EPR	Diaphragm, EPDM Rubber .....	0.73
CP21953-VI	Diaphragm, FKM .....	2.25
CP4624	Retainer Cap, Brass .....	4.24
21950-*-NYB	ChemSaver End Cap Sub-assembly .....	5.45
56720-1/8-B or F	Air ChemSaver Nozzle Body Shutoff .....	55.10
55300	Air ChemSaver Nozzle Body Shutoff .....	55.10
55300-1	Air ChemSaver Nozzle Body Shutoff for QJS .....	55.10
9758	Brass End Cap ASB .....	7.01
CP56709-VI	QJS Diaphragm, FKM .....	3.72
56714-NYB	QJS End Cap Sub-assembly .....	7.89
CP56711-NYB	Retaining Ring .....	2.04
115880-*-12	e-ChemSaver <sup>®</sup> Electric Tip Shutoff (12VDC) .....	267.40
115880-*-24	e-ChemSaver <sup>®</sup> Electric Tip Shutoff (24VDC) .....	267.40
116280-12	DynaJet <sup>®</sup> HF Valve (12VDC) .....	308.00
116280-24	DynaJet <sup>®</sup> HF Valve (24VDC) .....	308.00
116950-12	e-ChemSaver <sup>®</sup> EcoStop (12VDC) .....	179.20
116950-24	e-ChemSaver <sup>®</sup> EcoStop (24VDC) .....	179.20
58140-NYB	Manual ChemSaver .....	9.09
98465-15	Check Valve End Cap Assembly .....	24.63

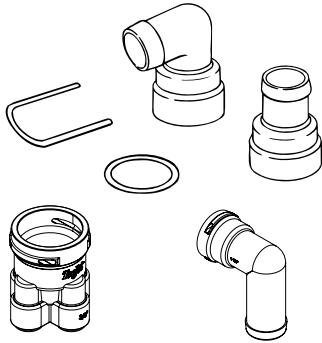

**QUICK CONNECT FITTINGS  
FOR VALVES AND MANIFOLDS**

45529-1/2	1/2" Straight Hose Barb .....	\$ 12.94
45529-3/4	3/4" Straight Hose Barb .....	12.94
45529-5/8	5/8" Straight Hose Barb .....	12.94
45529-1	1" Straight Hose Barb .....	12.94
45529-3/4M	3/4" Straight Hose Barb x Male Quick Connect .....	12.94
45529-1M	1" Straight Hose Barb x Male Quick Connect .....	12.94
45529-90-1/2	1/2" 90° Hose Barb .....	12.94
45529-90-5/8	5/8" 90° Hose Barb .....	12.94
45529-90-3/4	3/4" 90° Hose Barb .....	12.94
45529-90-1	1" 90° Hose Barb .....	12.94
45529-90-1-1/4	1-1/4" 90° Hose Barb .....	12.94
45529-C	Quick Connect Cap .....	12.94
45529-P	Quick Connect Plug .....	12.94
45529-PTC-4-3/8	3/8" Push-to-Connect, 4-Outlets .....	59.35

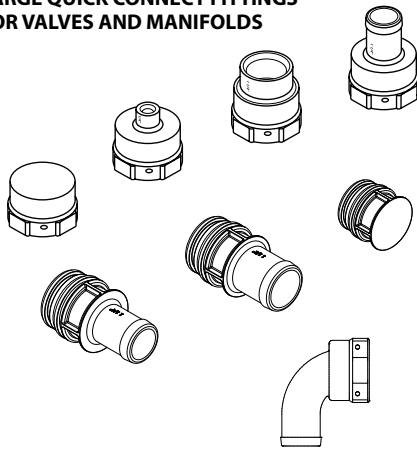
**LARGE QUICK CONNECT FITTINGS  
FOR VALVES AND MANIFOLDS**

\*Also available in BSPT Threads

\*\*All Quick Connect fittings come with clip and O-ring

(B)58456-1/4	Large Quick Connect x 1/4" Female NPT* Gauge Port .....	25.02
(B)58456-3/4	Large Quick Connect x 3/4" Female NPT* .....	25.02
(B)58456-1	Large Quick Connect x 1" Female NPT* .....	25.02
(B)58456-1-1/4	Large Quick Connect x 1 1/4" Female NPT* .....	25.02
(B)58456-1-1/2	Large Quick Connect x 1 1/2" Female NPT* .....	25.02
58456-1000	Large Quick Connect x 1"/25 mm Hose Barb .....	25.02
58456-1250	Large Quick Connect x 1 1/4"/32 mm Hose Barb .....	25.02
58456-1500	Large Quick Connect x 1 1/2"/38 mm Hose Barb .....	25.02
58456-2000	Large Quick Connect x 2"/51 mm Hose Barb .....	25.02
58456-C	Large Quick Connect Cap .....	25.02
58456-90-1000	1" Large Quick Connect 90 Degree Hose Barb .....	25.02
58456-90-1250	1-1/4" Large Quick Connect 90 Degree Hose Barb .....	25.02
58456-90-1500	1-1/2" Large Quick Connect 90 Degree Hose Barb .....	25.02
58456-90-2000	2" Large Quick Connect 90 Degree Hose Barb .....	25.02
58456-1250M	1-1/4" Hose Barb Outlet x Male Large Quick Connect .....	25.02
58456-1500M	1-1/2" Hose Barb Outlet x Male Large Quick Connect .....	25.02
58456-P	Large Quick Connect Plug .....	25.02

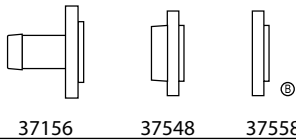
**AA440 MANIFOLD INLET/BYPASS CONNECTIONS**

CP37156-PP	1" Straight Hose Barb .....	12.67
CP(B)37548-PP	1" Threaded Inlet .....	12.67
CP37558-PP	Blank Inlet .....	12.67
CP39584-PP	1/4" Straight Hose Barb .....	12.67
CP37684-PP	1/4" Threaded Gauge Port .....	12.67
<i>(B) = BSPT</i>		

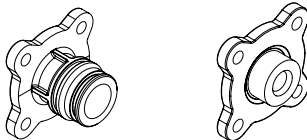
**4-BOLT MANIFOLD FLANGE FITTINGS**

CP98542-NYB	98542 Male Quick Connect End Cap .....	20.43
CP116241-1-1/4-NYB	Bolted Flange Gauge Port 1/4" NPT .....	20.43
CPB116241-1-1/4-NYB	Bolted Flange Gauge Port 1/4" BSPT .....	20.43
CP116241-1-3/8-NYB	Bolted Flange Gauge Port 3/8" NPT .....	20.43
CPB116241-1-3/8-NYB	Bolted Flange Gauge Port 3/8" BSPT .....	20.43
CP116241-NYB	Flange End Cap .....	20.43

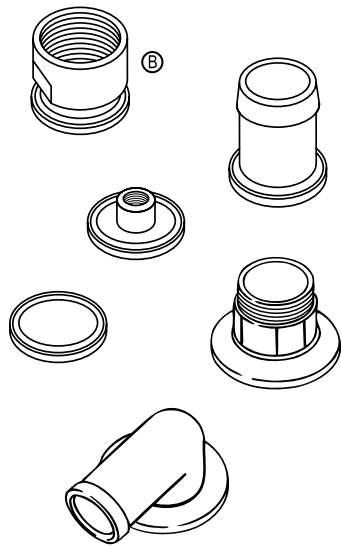
**FLANGED FITTINGS**

**50 Series Flanged Fittings:**

CP48150-PP	50 Series x 3/4" Hose Barb .....	\$ 2.98
CP45504-PP	50 Series x 1" Hose Barb .....	2.98
CP45505-PP	50 Series x 1 1/4" Hose Barb .....	2.98
CP45506-PP	50 Series x 1 1/2" Hose Barb .....	3.35
CP48151-PP	50 Series x 3/4" 90° Hose Barb .....	3.66
CP48152-PP	50 Series x 1" 90° Hose Barb .....	3.66
CP72238-PP	50 Series x 1 1/4" 90° Hose Barb .....	9.75
CP72239-PP	50 Series x 1 1/2" 90° Hose Barb .....	9.75
CP(B)48172-PP	50 Series x 3/4" Male NPT* .....	3.44
CP(B)48155-PP	50 Series x 1" Male NPT* .....	3.44
CP(B)48156-PP	50 Series x 1 1/2" Male NPT* .....	3.71
CP(B)48154-PP	50 Series x 1" Female NPT* .....	3.44
CP(B)45512-PP	50 Series x 1 1/4" Female NPT* .....	3.84
CP(B,P)45508-1/4-PP	50 Series x 1/4" Female NPT* .....	3.84
CP(B,P)45539-3/8-PP	50 Series x 3/8" Female NPT* .....	3.84
CP45507-PP	50 Series x Blank .....	3.44
CP46029-PP	50 Series x Male Quick Connect .....	7.32
CP48157-PP	50 Series x 50 Series Straight Coupling .....	7.32
CP48158-PP	50 Series x 50 Series Elbow Coupling .....	9.75
CP(B)48159-PP	50 Series x 3/4" Female NPT* .....	3.44
CP50193-PP	50 Series Tee Body .....	19.60
CP55242-PP	50 Series Tee Body Narrow .....	19.60

**75 Series Flanged Fittings:**

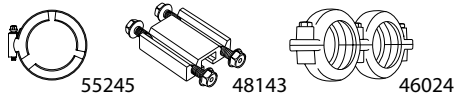
CP48160-PP	75 Series x 1 1/4" Hose Barb .....	7.89
CP46067-PP	75 Series x 1 1/2" Hose Barb .....	7.89
CP48161-PP	75 Series x 2" Hose Barb .....	7.89
CP48162-PP	75 Series x 1 1/4" 90° Hose Barb .....	13.35
CP48163-PP	75 Series x 1 1/2" 90° Hose Barb .....	13.35
CP48164-PP	75 Series x 2" 90° Hose Barb .....	13.35
CP(B)48165-PP	75 Series x 1 1/4" Male NPT* .....	6.99
CP(B)48166-PP	75 Series x 1 1/2" Male NPT* .....	6.99
CP(B)46066-PP	75 Series x 1 1/2" Female NPT* .....	9.53
CP(B)48167-PP	75 Series x 2" Male NPT* .....	6.99
CP(B)46127-1/4-PP	75 Series x 1/4" Female NPT* .....	9.53
CP(B)46127-3/8-PP	75 Series x 3/8" Female NPT* .....	9.53
CP46069-PP	75 Series x Blank .....	7.89
CP48169-PP	75 Series x 75 Series Straight Coupling .....	20.43
CP48168-PP	75 Series x 75 Series Elbow Coupling .....	18.27
CP46716-PP	75 Series x 75 Series x 75 Series Tee .....	20.91
CP46717-PP	75 Series x 75 Series x 50 Series Tee .....	19.60
CP45207-PP	75 Series x 50 Series Reducer .....	20.43
CP45251-PP	450 Tee Body .....	29.54
CP55224-PP	450 Tee Body Narrow .....	29.54

*(B) = BSPT (P) = BSPP*
*\*Also available with BSPT connection*
**FLANGE CLAMPS**

46024	#50 Series 3-Way Clamp & O-ring Kit .....	32.36
55245-50	#50 Series Stainless Steel Clamp & O-ring Kit .....	16.81
55245-75	#75 Series Stainless Steel Clamp & O-ring Kit .....	17.21
48143	Bar Mounting Kit .....	21.18
46070	#50 Series Nylon Clamp & O-ring Kit .....	25.29

**FLOW METERS**

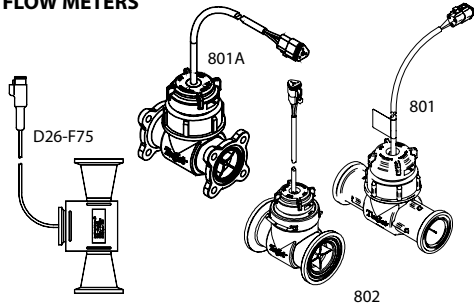

801	801 Flow Meter with 50 Series Flanged Inlets .....	\$ 983.76
801A	801 Flow Meter with 430 Bolted Manifold Inlets .....	983.76
D26-F75	D26 Flow Meter with 75 Series Flanged Inlets .....	1,129.89
802	802 Flow Meter with 75 Series Flanged Inlets .....	1,053.15

## DirectoValve® ELECTRICALLY OPERATED VALVES

**DIRECTOVALVE BALL VALVES\***

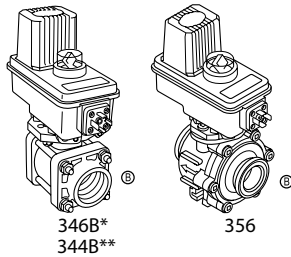

\* To include mounting bracket specify 366B  
\*\* To include mounting bracket specify 364B

(B)344BEC-2-C or D	¾", 1", Flanged or Quick Connect 2-Way Electric Shutoff Ball Valve .....	\$461.07
(B)344BEC-3-C or D	¾", 1", Flanged or Quick Connect 3-Way Electric Shutoff Ball Valve .....	564.25
(B)344BE-2-C or D	¾", 1", Flanged or Quick Connect 2-Way Electric Shutoff Ball Valve .....	461.07
(B)344BE-3-C or D	¾", 1", Flanged or Quick Connect 3-Way Electric Shutoff Ball Valve .....	564.25
356BEC-C or D	Flanged 2-Way Electric Shutoff Trunnion Valve .....	619.89
(B)346BEC-2-C or D	1¼", 1½" or Flanged 2-Way Electric Shutoff Ball Valve .....	859.91
(B)346BEC-3-C or D	1¼", 1½" or Flanged 3-Way Electric Shutoff Ball Valve .....	859.91

(B) = BSPT

**PRESSURE REGULATING VALVES\***

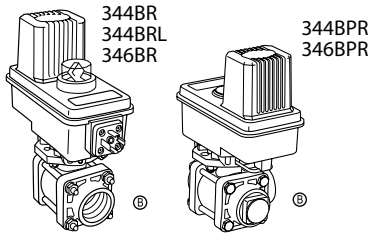

(B)344BR-2-C or D	¾", 1" or Flanged Regulating Ball Valve .....	473.85
(B)344BRL-2-C or D	¾", 1" or Flanged Linear Regulating Ball Valve .....	473.85
(B)344BPR-2-C or D	¾", 1" or Flanged Regulating Ball Valve .....	455.20
(B)346BR-2-C or D	1¼", 1½" or Flanged Regulating Ball Valve .....	991.88
(B)346BPR-2-C or D	1¼", 1½" or Flanged Regulating Ball Valve .....	991.88
(B)346BPR-3-C or D	1¼", 1½" or Flanged Regulating Ball Valve .....	991.88

Note: Regulating valves are available in 1, 3 or 6 RPM.  
PR valve cycle times are double that of R and RL regulating valves.  
(B) = BSPT

\*For 344 with mounting foot, specify 364B  
\*For 346 with mounting foot, specify 366B

## DirectoValve® REPLACEMENT SHUTOFF MOTOR HEADS

**REPLACEMENT MOTORS**

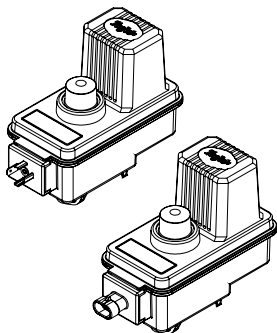

50515-22CP**	BEC Shutoff Motor, Cable, Pos Switched .....	\$ 390.57*
50515-22CN**	BEC Shutoff Motor, Cable, Neg Switched .....	390.57*
50515-22DP	BEC Shutoff Motor, DIN Pos Switched .....	390.57
50515-22DN	BEC Shutoff Motor, DIN, Neg Switched .....	390.57
50515-22P	BEC Shutoff Motor, Less Cable, Pos Switched .....	369.17
50515-22N	BEC Shutoff Motor, Less Cable, Neg Switched .....	369.17
50533-22C**	BE Shutoff Motor, Cable .....	390.57*
50533-22D	BE Shutoff Motor, DIN .....	390.57
50533-22	BE Shutoff Motor, Less Cable .....	369.17
50994-22CP**	BEC Normally Open Motor, Cable, Pos Switched .....	390.57*
50994-22CN**	BEC Normally Open Motor, Cable, Neg Switched .....	390.57*
50994-22DP	BEC Normally Open Motor, DIN, Pos Switched .....	390.57
50994-22DN	BEC Normally Open Motor, DIN, Neg Switched .....	390.57
50994-22P	BEC Normally Open Motor, Less Cable, Pos Switched .....	369.17
50994-22N	BEC Normally Open Motor, Less Cable, Neg Switched .....	369.17

\*\* Specify Cable Length of 05 (0.5m), 15 (1.5 m), 30 (3.0 m) or 60 (6.0 m)  
\*Prices Shown for 03 and 05 Cable Lengths

# DirectoValve® REPLACEMENT VALVE BODY ASSEMBLIES

**U.S.  
DOLLARS**

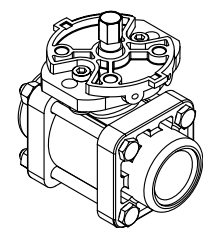

56601-2

56601-2*	344, 2-Way Poly Ball . . . . .	\$ 322.75
56601-2*-SS	344, 2-Way SS Ball . . . . .	445.31
56601-3*	344, 3-Way, Poly Ball . . . . .	395.01
56601-3*-SS	344, 3-Way SS Ball . . . . .	517.55
56601-2PR*	344, 2-Way, PR Poly Ball . . . . .	322.75
56601-2RL*	344, 2-Way, RL Poly Ball . . . . .	322.75
56601-2RL*-SS	344, 2-Way, RL SS Ball . . . . .	445.31
56603-2*	346, 2-Way, Poly Ball . . . . .	623.96
56603-2*-SS	346, 2-Way, SS Ball . . . . .	816.85
56603-3*	346, 3-Way, Poly Ball . . . . .	623.96
56603-3PR*	346, 3-Way, PR Poly Ball . . . . .	617.78
56605	356 2-Way, SS Trunnion . . . . .	425.30
56607-2*	440, 2-Way, Poly Ball . . . . .	336.51
56607-2*-SS	440, 2-Way, SS Ball . . . . .	459.06
56609-2(N)*	450, 2-Way, Poly Ball . . . . .	330.89
56609-2(N)*-SS	450, 2-Way, SS Ball . . . . .	444.56
56609-3FB*	450, Flowback, Poly Ball . . . . .	394.66
56609-3FB*-SS	450, Flowback, SS Ball . . . . .	458.43
56611-2*	460, 2-Way, SS Ball . . . . .	395.97
56611-3C*	460, 3-Way, SS Ball . . . . .	644.04
56611-3E*	460, 3-Way, SS Ball . . . . .	445.36
56611-3FB*-SS	460, Flowback, SS Ball . . . . .	445.36



## ADAPTER CABLES FOR BALL VALVES, MANIFOLDS AND E-CHEMSAVER®

**U.S.  
DOLLARS**



98546

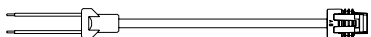

98552

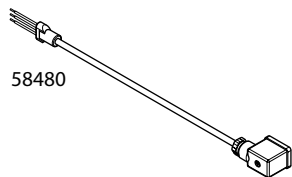

58480

98552-05	0.5 Meter MetriPack 2-wire Adapter Cable . . . . .	\$ 22.71
98552-15	1.5 Meter MetriPack 2-wire Adapter Cable . . . . .	29.27
98552-30	3.0 Meter MetriPack 2-wire Adapter Cable . . . . .	38.11
98552-60	6.0 Meter MetriPack 2-wire Adapter Cable . . . . .	46.92
98552-2-05	0.5 Meter MetriPack 2-wire Adapter Cable Sealed . . . . .	35.03
98552-2-15	1.5 Meter MetriPack 2-wire Adapter Cable Sealed . . . . .	42.11
98552-2-30	3.0 Meter MetriPack 2-wire Adapter Cable Sealed . . . . .	50.75
98552-2-60	6.0 Meter MetriPack 2-wire Adapter Cable Sealed . . . . .	56.35
98546EC-05	0.5 Meter MetriPack 3-wire Adapter Cable . . . . .	22.71
98546EC-15	1.5 Meter MetriPack 3-wire Adapter Cable . . . . .	29.27
98546EC-30	3.0 Meter MetriPack 3-wire Adapter Cable . . . . .	38.11
98546EC-60	6.0 Meter MetriPack 3-wire Adapter Cable . . . . .	46.92
58480-0	Mini-DIN Connector . . . . .	7.07
58480E(C)-05	0.5 Meter Mini-DIN with Flying Leads . . . . .	23.13
58480E(C)-05*	0.5 Meter Mini-DIN with Faston Connection . . . . .	33.96
58480E(C)-05**	0.5 Meter Mini-DIN with Connector . . . . .	44.70
58480E(C)-15	1.5 Meter Mini-DIN with Flying Leads . . . . .	28.20
58480E(C)-15*	1.5 Meter Mini-DIN with Faston Connection . . . . .	39.02
58480E(C)-15**	1.5 Meter Mini-DIN with Connector . . . . .	51.26
58480E(C)-30	3.0 Meter Mini-DIN with Flying Leads . . . . .	47.32
58480E(C)-30*	3.0 Meter Mini-DIN with Faston Connection . . . . .	58.16
58480E(C)-30**	3.0 Meter Mini-DIN with Connector . . . . .	68.89

Note: E version = 2-wire, EC version = 3-wire

# DirectoValve® ELECTRIC MANIFOLD VALVES

U.S. DOLLARS

ALL "B" TYPE DIRECTOVALVES ARE AVAILABLE WITH CABLE (C) OR DIN (D) ELECTRICAL CONNECTIONS  
 ALL "430" AND "530" DIRECTOVALVES ARE AVAILABLE WITH DIN (D) OR METRIPACK (P) CONNECTIONS  
 ALL "540" DIRECTOVALVES ARE AVAILABLE WITH METRIPACK (P) CONNECTIONS

STAINLESS STEEL BALL

POLYPROPYLENE BALL

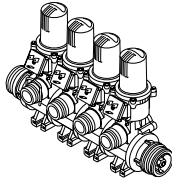
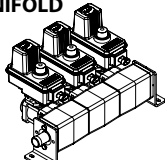
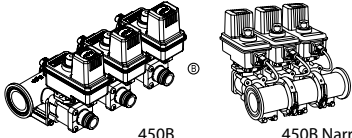
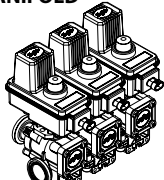
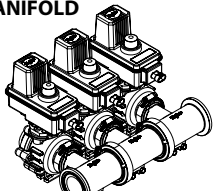
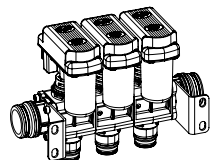
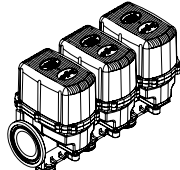
<p><b>430 2-WAY MANIFOLD</b></p> 	<p><b>Stainless Steel Ball &amp; Stem</b></p> <p>431EC-2-P or D      2-Way DirectoValve Manifold . . . . . \$ 344.54*</p> <p>432EC-2-P or D      2-Way DirectoValve Manifold . . . . . 582.97*</p> <p>433EC-2-P or D      2-Way DirectoValve Manifold . . . . . 843.06*</p> <p>434EC-2-P or D      2-Way DirectoValve Manifold . . . . . 1,127.06*</p> <p>435EC-2-P or D      2-Way DirectoValve Manifold . . . . . 1,408.85*</p> <p><i>Manifold assemblies are available with a variety of inlets/outlets.                      Contact your TeeJet dealer or sales office for more information. (B) = BSPT</i></p>		
<p><b>440B 2-WAY MANIFOLD</b></p> 	<p>(B)441BEC-C or D      DirectoValve Manifold . . . . . 698.06</p> <p>(B)442BEC-C or D      DirectoValve Manifold . . . . . 1,357.90</p> <p>(B)443BEC-C or D      DirectoValve Manifold . . . . . 2,074.78</p> <p>(B)444BEC-C or D      DirectoValve Manifold . . . . . 2,688.25</p> <p>(B)445BEC-C or D      DirectoValve Manifold . . . . . 3,348.90</p> <p><i>Manifold assemblies are available with a variety of inlets/outlets.                      Contact your TeeJet dealer or sales office for more information. (B) = BSPT</i></p>		<p>\$ 575.44</p> <p>1,112.67</p> <p>1,656.90</p> <p>2,197.84</p> <p>2,735.76</p>
<p><b>450B 2-WAY MANIFOLD</b></p>  <p>450B      450B Narrow</p>	<p>(B)451BEC-2(N)-C or D      DirectoValve Manifold . . . . . 595.30</p> <p>(B)452BEC-2(N)-C or D      DirectoValve Manifold . . . . . 1,173.28</p> <p>(B)453BEC-2(N)-C or D      DirectoValve Manifold . . . . . 1,844.96</p> <p>(B)454BEC-2(N)-C or D      DirectoValve Manifold . . . . . 2,469.82</p> <p>(B)455BEC-2(N)-C or D      DirectoValve Manifold . . . . . 3,094.67</p> <p><i>Manifold assemblies are available with a variety of inlets/outlets.                      Contact your TeeJet dealer or sales office for more information. (B) = BSPT</i></p>		<p>472.72</p> <p>974.97</p> <p>1,477.14</p> <p>1,957.58</p> <p>2,437.90</p>
<p><b>460B 2-WAY MANIFOLD</b></p> 	<p><b>Stainless Steel Ball &amp; Stem</b></p> <p>(B)461BEC-2-C or D      2-Way DirectoValve Manifold . . . . . 565.63</p> <p>(B)462BEC-2-C or D      2-Way DirectoValve Manifold . . . . . 1,156.22</p> <p>(B)463BEC-2-C or D      2-Way DirectoValve Manifold . . . . . 1,746.84</p> <p>(B)464BEC-2-C or D      2-Way DirectoValve Manifold . . . . . 2,337.46</p> <p>(B)465BEC-2-C or D      2-Way DirectoValve Manifold . . . . . 2,928.10</p> <p><i>Manifold assemblies are available with a variety of inlets/outlets.                      Contact your TeeJet dealer or sales office for more information. (B) = BSPT</i></p>		
<p><b>490B 2-WAY MANIFOLD</b></p> 	<p><b>Stainless Steel Ball &amp; Stem</b></p> <p>(B)491BEC-C or D      356 Trunnion Valve Manifold . . . . . 686.43</p> <p>(B)492BEC-C or D      356 Trunnion Valve Manifold . . . . . 1,389.76</p> <p>(B)493BEC-C or D      356 Trunnion Valve Manifold . . . . . 2,093.09</p> <p>(B)494BEC-C or D      356 Trunnion Valve Manifold . . . . . 2,796.45</p> <p>(B)495BEC-C or D      356 Trunnion Valve Manifold . . . . . 3,499.77</p> <p><i>Manifold assemblies are available with a variety of inlets/outlets.                      Contact your TeeJet dealer or sales office for more information. (B) = BSPT</i></p>		
<p><b>530A 2-WAY MANIFOLD</b></p> 	<p><b>Plunger Valve</b></p> <p>531AEC-2-P or D      2-Way DirectoValve Manifold . . . . . 344.52*</p> <p>532AEC-2-P or D      2-Way DirectoValve Manifold . . . . . 625.75*</p> <p>533AEC-2-P or D      2-Way DirectoValve Manifold . . . . . 907.26*</p> <p>534AEC-2-P or D      2-Way DirectoValve Manifold . . . . . 1,212.68*</p> <p>535AEC-2-P or D      2-Way DirectoValve Manifold . . . . . 1,515.87*</p> <p><i>Manifold assemblies are available with a variety of inlets/outlets.                      Contact your TeeJet dealer or sales office for more information.</i></p>		
<p><b>540 2-WAY MANIFOLD</b></p> 	<p><b>Plunger Valve</b></p> <p>541EC-2      2-Way DirectoValve Manifold . . . . . 442.65</p> <p>542EC-2      2-Way DirectoValve Manifold . . . . . 901.79</p> <p>543EC-2      2-Way DirectoValve Manifold . . . . . 1,360.97</p> <p>544EC-2      2-Way DirectoValve Manifold . . . . . 1,820.19</p> <p>545EC-2      2-Way DirectoValve Manifold . . . . . 2,279.32</p> <p><i>Manifold assemblies are available with a variety of inlets/outlets.                      Contact your TeeJet dealer or sales office for more information.                      Power cable not included. 98546-* cable must be ordered separately.</i></p>		

(B) Also available with BSPT connection  
 \* DIN Connection (-D) pricing shown.

# DirectoValve® ELECTRIC MANIFOLD VALVES

U.S. DOLLARS

ALL "B" TYPE DIRECTOVALVES ARE AVAILABLE WITH CABLE (C) OR DIN (D) ELECTRICAL CONNECTIONS  
ALL "430" AND "530" DIRECTOVALVES ARE AVAILABLE WITH DIN (D) OR METRIPACK (P) CONNECTIONS

STAINLESS STEEL BALL

POLYPROPYLENE BALL

## 430, 450B, 460B AND 530A FLOW BACK VALVES

### Stainless Steel Ball & Stem

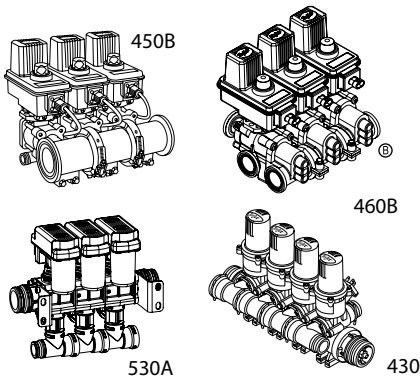

431EC-3FB-D	2-Way DirectoValve Flow Back Manifold....	\$ 372.11*	
433EC-3FB-D	2-Way DirectoValve Flow Back Manifold....	989.96*	
435EC-3FB-D	2-Way DirectoValve Flow Back Manifold....	1,649.93*	
(B)451BEC-3FB-C or D	2-Way DirectoValve Flow Back Manifold....	654.80	\$ 519.93
(B)453BEC-3FB-C or D	2-Way DirectoValve Flow Back Manifold....	2,029.45	1,624.82
(B)455BEC-3FB-C or D	2-Way DirectoValve Flow Back Manifold....	3,404.15	2,753.58
(B)461BEC-3FB-C or D	2-Way DirectoValve Flow Back Manifold....	976.61	
(B)463BEC-3FB-C or D	2-Way DirectoValve Flow Back Manifold....	2,994.07	
(B)465BEC-3FB-C or D	2-Way DirectoValve Flow Back Manifold....	5,012.36	
531AEC-FB-D	2-Way DirectoValve Flow Back Manifold....	372.09*	
533AEC-FB-D	2-Way DirectoValve Flow Back Manifold....	989.95*	
535AEC-FB-D	2-Way DirectoValve Flow Back Manifold....	1,649.91*	

Manifold assemblies are available with a variety of inlets/outlets.  
Contact your TeeJet dealer or sales office for more information. (B) = BSPT

# DirectoValve® ELECTRIC MANIFOLD 3-WAY VALVES

U.S. DOLLARS

## 430 3-WAY MANIFOLD

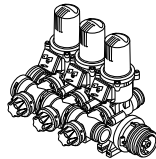

### Stainless Steel Ball & Stem

431EC-3-P or D	Shutoff/Bypass DirectoValve Manifold .....	\$ 412.75*
433EC-3-P or D	Shutoff/Bypass DirectoValve Manifold .....	1,170.52*
435EC-3-P or D	Shutoff/Bypass DirectoValve Manifold .....	1,976.22*

Manifold assemblies are available with a variety of inlets/outlets.  
Contact your TeeJet dealer or sales office for more information. (B) = BSPT

## 460B 3-WAY MANIFOLD (E)

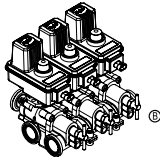

### Stainless Steel Ball & Stem

(B)461BEC-3E-C or D	Shutoff/Bypass DirectoValve Manifold .....	917.07
(B)463BEC-3E-C or D	Shutoff/Bypass DirectoValve Manifold .....	2,815.37
(B)465BEC-3E-C or D	Shutoff/Bypass DirectoValve Manifold .....	4,771.14

Manifold assemblies are available with a variety of inlets/outlets.  
Contact your TeeJet dealer or sales office for more information. (B) = BSPT

## 460B 3-WAY MANIFOLD (C)

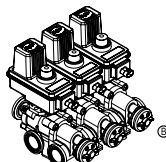

### Stainless Steel Ball & Stem

(B)461BEC-3C-C or D	Shutoff/Bypass DirectoValve Manifold .....	810.06
(B)463BEC-3C-C or D	Shutoff/Bypass DirectoValve Manifold .....	2,559.57
(B)465BEC-3C-C or D	Shutoff/Bypass DirectoValve Manifold .....	4,178.69

Manifold assemblies are available with a variety of inlets/outlets.  
Contact your TeeJet dealer or sales office for more information. (B) = BSPT

## 530A 3-WAY MANIFOLD

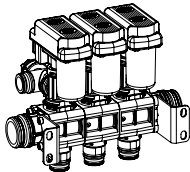

### Plunger Valve

531AEC-3-P or D	Shutoff/Bypass DirectoValve Manifold .....	391.34*
533AEC-3-P or D	Shutoff/Bypass DirectoValve Manifold .....	1,106.30*
535AEC-3-P or D	Shutoff/Bypass DirectoValve Manifold .....	1,869.19*

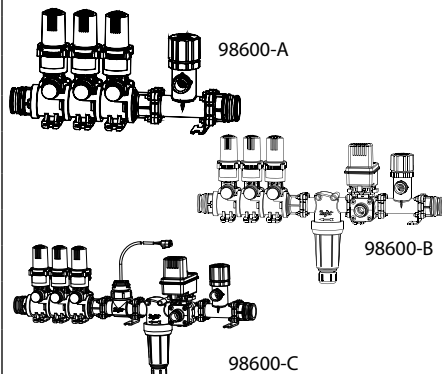

Manifold assemblies are available with a variety of inlets/outlets.  
Contact your TeeJet dealer or sales office for more information.

## 430 CONTROL VALVE ASSEMBLIES

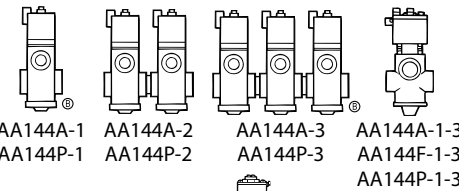

98600-A-435EC	2-Way Manifold with Pressure Relief Valve .....	1,700.25
98601-A-435EC	Flow Back Manifold with Pressure Relief Valve .....	1,834.27
98602-A-435EC	3-Way Manifold with Pressure Relief Valve .....	2,160.60
98600-B-435EC	2-Way Manifold with Strainer, PRV and Reg Valve .....	2,283.24
98601-B-435EC	Flow Back Manifold with Strainer, PRV and Reg Valve ..	2,467.72
98602-B-435EC	3-Way Manifold with Strainer, PRV and Reg Valve .....	2,743.61
98600-C-435EC	2-Way w/ Flow Meter, PRV, Str, Reg Valve .....	3,266.93
98601-C-435EC	Flow Back w/ Flow Meter, PRV, Str, Reg Valve .....	3,400.98
98602-C-435EC	3-Way w/ Flow Meter, PRV, Str, Reg Valve .....	3,727.29

Control valve assemblies are available in a variety of sizes and configurations.  
Contact your TeeJet dealer or sales office for more information.

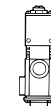
<b>TeeJet® TECHNOLOGIES</b>		<b>ELECTRIC SOLENOID VALVES</b>		<b>U.S. DOLLARS</b>
<b>DIRECTOVALVE® CONTROL VALVES ELECTRONICALLY OPERATED</b>		AA(B)144A-1	Polypropylene (100 PSI/7 bar, 10 GPM/37.9 l/min rating) . . . . .	\$ 232.88
		AA(B)144A-2	Polypropylene (100 PSI/7 bar, 10 GPM/37.9 l/min rating) . . . . .	471.74
AA144A-1 AA144P-1	AA144A-2 AA144P-2	AA(B)144A-3	Polypropylene (100 PSI/7 bar, 10 GPM/37.9 l/min rating) . . . . .	710.65
		AA(B)144P-1	Polypropylene (100 PSI/7 bar, 10 GPM/37.9 l/min rating) . . . . .	320.94
		AA(B)144P-2	Polypropylene (100 PSI/7 bar, 10 GPM/37.9 l/min rating) . . . . .	641.75
		AA(B)144P-3	Polypropylene (100 PSI/7 bar, 10 GPM/37.9 l/min rating) . . . . .	962.51
		AA(B)144A-1-3	Polypropylene (3 way, 65 PSI/4.5 bar, 8 GPM/30 l/min rating) ..	316.87
		AA(B)144P-1-3	Polypropylene (3 way, 65 PSI/4.5 bar, 8 GPM/30 l/min rating) ..	383.67
		AA(B)144F-1-3	Polypropylene (3 way, 50 PSI/3.5 bar, 8 GPM/30 l/min rating) ..	260.94
		AA145H-1	Nylon (100 PSI/7 bar, 15 GPM/56.7 l/min rating) . . . . .	533.16
 CP21737	 AA145H	CP21737-NYB	¾" Close Nipple Black Nylon (144A 144P 2-Way) . . . . .	7.08

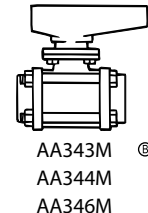
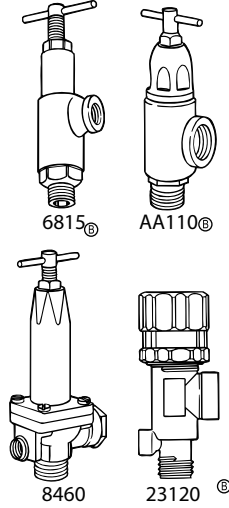
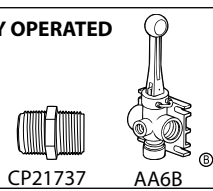
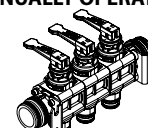
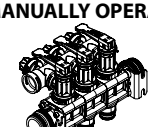
<b>TeeJet® TECHNOLOGIES</b>		<b>MANUALLY OPERATED VALVES</b>		<b>U.S. DOLLARS</b>
<b>DIRECTOVALVE BALL VALVES</b>		AA(B)343M-2-(3/8 or 1/2)-PP	Manually Operated, 2-Way, Polypropylene . . . . .	\$ 66.19
		AA(B)343M-3-(3/8 or 1/2)-PP	Manually Operated, 3-Way, Polypropylene . . . . .	80.02
		AA(B)344M-2-3/4 or 1	Manually Operated, 2-Way, Nylon . . . . .	89.81
		*AA344M-2-F	Manually Operated, 2-Way, Nylon . . . . .	89.81
		AA(B)344M-3-3/4 or 1	Manually Operated, 3-Way, Nylon . . . . .	108.60
		AA(B)344M-2-(3/4 or 1)-PP	Manually Operated, 2-Way, Polypropylene . . . . .	67.77
		AA(B)344M-3-(3/4 or 1)-PP	Manually Operated, 3-Way, Polypropylene . . . . .	81.98
		AA(B)346M-2-(1-1/4 or 1-1/2)-PP	Manually Operated, 2-Way, Polypropylene . . . . .	108.89
		AA(B)346M-3-(1-1/4 or 1-1/2)-PP	Manually Operated, 3-Way, Polypropylene . . . . .	132.03
		<i>*See page 15 for 50 Series Flanges</i>		
		<i>(B) = BSPT</i>		
<b>PRESSURE RELIEF/REGULATING VALVES</b>		AA(B)110-(1/4 or 3/8)-*-	Brass . . . . .	83.22
		AA(B)110-1	Brass . . . . .	368.07
		AA(B)110-1-DI	Ductile Iron . . . . .	284.95
		AA(B)110-1-AL	Aluminum . . . . .	236.49
		AA(B)110-1-1/4	Brass . . . . .	378.11
		AA(B)110-(1-1/4 or 1-1/2)-DI	Ductile Iron . . . . .	295.81
		AA(B)110-(1-1/4 or 1-1/2)-AL	Aluminum . . . . .	256.30
		AA(B)110-1-1/2	Brass . . . . .	378.11
		(B)6815-1/2, -3/4	Brass . . . . .	110.53
		(B)6815G-1/2-300, -3/4-300	With Guide Vane, Brass (300 PSI/20 bar) . . . . .	203.21
		(B)6815G-1/2-700, -3/4-700	With Guide Vane, Brass (700 PSI/48 bar) . . . . .	203.21
		(B)6815-1/2-HSS, -3/4-HSS	Brass with Hardened Stainless Steel Valve Seats (not 1200) ..	156.15
		8460-1/2, -3/4	Nylon . . . . .	95.25
		(B)23120-(1/2 or 3/4)-PP	Polypropylene . . . . .	51.91
		(B)23120A-(1/2 or 3/4)-PP	Polypropylene with FKM and 316-SS . . . . .	78.38
		(B)23120-1/2-PP-60-VI	Polypropylene with FKM . . . . .	78.38
		(B)23120-3/4-PP-60-VI	Polypropylene with FKM . . . . .	78.38
		<i>(B) = BSPT</i>		
<b>DIRECTOVALVE MANUALLY OPERATED CONTROL VALVE</b>		AA(B)6B	Manually Operated Control Valve . . . . .	76.61
		CP21737-NYB	¾" Close Nipple Black Nylon . . . . .	7.08
		<i>(B) = BSPT</i>		
<b>530A 2-WAY MANUALLY OPERATED MANIFOLD</b>		531AM-2	Manually Operated, 2-Way Manifold . . . . .	103.92
		532AM-2	Manually Operated, 2-Way Manifold . . . . .	145.93
		533AM-2	Manually Operated, 2-Way Manifold . . . . .	187.94
		534AM-2	Manually Operated, 2-Way Manifold . . . . .	229.94
		535AM-2	Manually Operated, 2-Way Manifold . . . . .	271.94
<b>530A 3-WAY MANUALLY OPERATED MANIFOLD</b>		531AM-3	Manually Operated, 3-Way Manifold . . . . .	146.92
		532AM-3	Manually Operated, 3-Way Manifold . . . . .	231.92
		533AM-3	Manually Operated, 3-Way Manifold . . . . .	316.93
		534AM-3	Manually Operated, 3-Way Manifold . . . . .	401.95
		535AM-3	Manually Operated, 3-Way Manifold . . . . .	488.11

ⓑ Also available with BSPT connection

# TeeJet<sup>®</sup> TECHNOLOGIES

## MANUALLY OPERATED VALVES

**U.S.  
DOLLARS**

**TEEVALVE<sup>®</sup> MANUAL CONTROL VALVE**

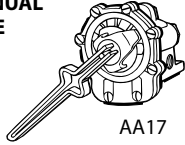

AA17

AA17Y  
AA17L

Aluminum, with 1" NPT Inlet Connection .....  
Aluminum, with ¾" NPT Inlet Connection.....

\$ 194.53  
194.53

**THROTTLING VALVES**

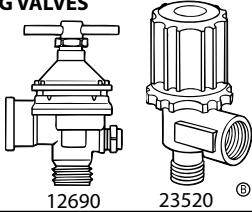

12690

23520<sup>®</sup>

12690-1/2-NYB, -3/4-NYB  
  
(B)23520-1/2-PP, -3/4-PP  
  
(B) = BSPT

Throttling Valve, Nylon .....  
  
Throttling Valve, Polypropylene.....

139.93  
  
44.98

# GunJet<sup>®</sup> SPRAY GUNS

**U.S.  
DOLLARS**

**GUNJET SPRAY GUNS**

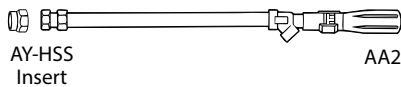

AY-HSS  
Insert

AA2

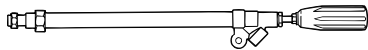

AA143-AL



AA23H

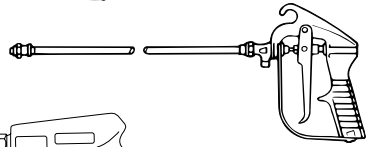

AA23L-7676<sup>®</sup>



AA30<sup>®</sup>

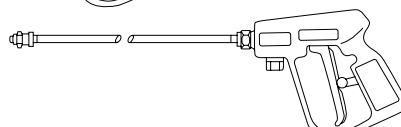

AA30L-22425<sup>®</sup>

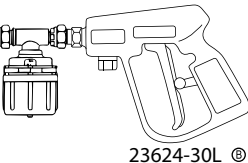

23624-30L<sup>®</sup>

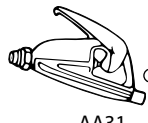

AA31<sup>®</sup>

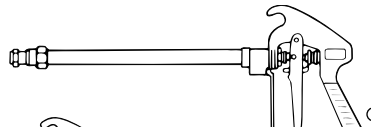

AA43L or AA43H<sup>®</sup>

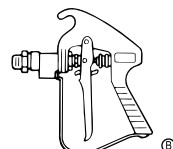

AA43L  
or AA43H



DX-HSS tip

AA2  
AA2A  
AA2-AL  
AA2A-AL  
AY-HSS  
AA143-AL-3/4, or -GH  
AA23L  
AA23H  
AA23L-7676-8  
AA23L-7676-18  
AA23L-7676-24  
AA23L-7676-36  
AA23L-7676-48  
AA(B)30L-PP  
AA(B)30L-1/4  
AA(B)30-1/4  
AA(B)30L-22425-8  
AA(B)30L-22425-18  
AA(B)30L-22425-24  
AA(B)30L-22425-36  
AA(B)30L-22425-48  
AA31  
AA31TL  
(B)23624-30L-1/4  
8604  
AA(B)43L or 43H  
AA(B)43L-AL or 43H-AL  
AA(B)43LA or 43HA  
AA(B)43LB  
AA(B)43LC-1/2, -3/4, 43HC-1/2, -3/4  
AA(B)43LD  
AA(B)43HD  
AA(B)43LA-AL or 43HA-AL  
AA(B)43LB-AL or 43HB-AL  
AA(B)43LC-1/2, -3/4, 43HC-1/2, -3/4AL  
AA(B)43LD-AL  
AA(B)43HD-AL  
DX-HSS

Brass, with AY-SS — Orifice Insert .....  
Brass, with AY-SS — Orifice Insert .....  
Aluminum, with AY-SS — Orifice Insert .....  
Aluminum, with AY-SS — Orifice Insert .....  
Orifice Insert only for #2 GunJet .....  
GunJet Aluminum .....  
Brass Inlet Body and Cap, less Tip .....  
Brass Inlet Body and Cap, less Tip .....  
(With 8"/20 cm Extension) Brass, with Cap, less Tip .....  
(With 18"/46 cm Extension) Brass, with Cap, less Tip .....  
(With 24"/61 cm Extension) Brass, with Cap, less Tip .....  
(With 36"/91 cm Extension) Brass, with Cap, less Tip .....  
(With 48"/122 cm Extension) Brass, with Cap, less Tip ....  
With Cap, less Tip .....  
With Cap, less Tip .....  
With Cap, less Tip .....  
(With 8"/20 cm Extension) Brass, with Cap, less Tip .....  
(With 18"/46 cm Extension) Brass, with Cap, less Tip .....  
(With 24"/61 cm Extension) Brass, with Cap, less Tip .....  
(With 36"/91 cm Extension) Brass, with Cap, less Tip .....  
(With 48"/122 cm Extension) Brass, with Cap, less Tip ....  
Brass, with Cap, less Tip.....  
With Trigger Lock, Brass, with Cap, less Tip .....  
MeterJet Spray Gun .....  
Inlet Strainer for No. 23L and No. 31 GunJet Spray Guns .  
Brass, with D-Disc Tip.....  
Aluminum, with D-Disc Tip .....  
Brass, with D-Disc Tip.....  
Brass, less Cap and Tip.....  
Brass .....  
Brass, less Cap and Tip.....  
Brass, less Cap and Tip.....  
Aluminum, with D-Disc Tip .....  
Aluminum, less Cap and Tip .....  
Aluminum .....  
Aluminum, less Cap and Tip .....  
Aluminum, less Cap and Tip .....  
Aluminum .....  
Aluminum, less Cap and Tip .....  
Aluminum, less Cap and Tip .....  
Spray Tip for #43 GunJet, Hardened Stainless Steel .....

\$ 264.39  
217.88  
183.15  
167.70  
14.25  
136.42  
103.09  
105.98  
153.09  
163.20  
172.98  
186.93  
222.58  
78.49  
94.62  
94.62  
149.16  
158.94  
168.47  
193.52  
217.88  
111.00  
100.52  
217.94  
23.61  
254.68  
211.59  
230.73  
206.34  
204.81  
191.41  
204.81  
202.67  
193.23  
204.81  
179.14  
186.06  
36.78



# GunJet® SPRAY GUNS AND ACCESSORIES

**U.S.  
DOLLARS**

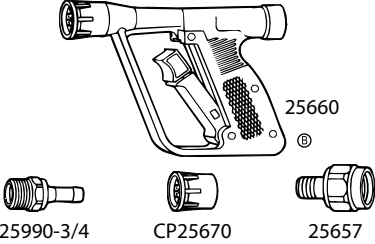
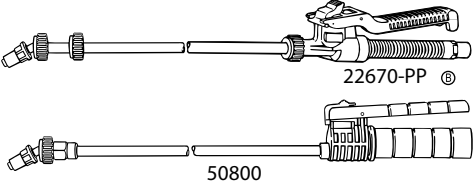
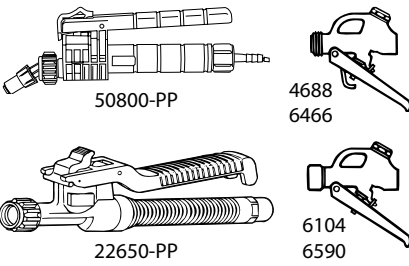
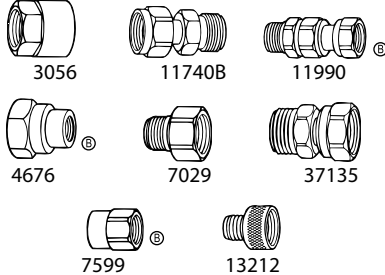
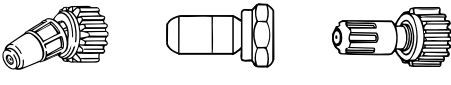
<b>GunJet® SPRAY GUNS AND ACCESSORIES</b>		<b>U.S. DOLLARS</b>	
<b>TEEJET® LAWN SPRAY GUN</b>			
	25660-1.5, 3.0, or 4.0	TeeJet Lawn Spray Gun with Nozzle . . . . .	\$ 147.72
	(B)25660-0	TeeJet Lawn Spray Gun without Nozzle . . . . .	129.38
	CP25670-* -NY	Nozzle for TeeJet Lawn Spray Gun . . . . .	20.85
	25990-3/4 and -GGH	Hose Shank Swivel . . . . .	19.14
	25657-NYB	Lawn Gun Adapter . . . . .	32.65
<i>*Note: Extension No. 22665 can be found on page 21.</i>			
<b>TRIGGERJET® SPRAY GUN WITH EXTENSION, STRAINER AND TIP</b>			
	(B)22670-PP-15-*	TriggerJet with Extension; Polypropylene, with Spray Tip . . . . .	65.88
	(B)22670-PP-24-*	TriggerJet with Extension; Polypropylene, with Spray Tip . . . . .	75.94
	(B)22570-PP-15-*	TriggerJet with Extension; Polypropylene, without Spray Tip . . . . .	59.31
	22570-PP-24-*	TriggerJet with Extension; Polypropylene, without Spray Tip . . . . .	69.11
	50800-15-PP-*	¼ or ¾ Hose Barb, 15" Extension, with Spray Tip . . . . .	24.09
	50800-21-AL-*	¼ or ¾ Hose Barb, 21" Extension, with Spray Tip . . . . .	28.79
<b>TRIGGER VALVES</b>			
	50800-PP-*	TriggerJet Spray Gun; Polypropylene . . . . .	18.51
	(B)22650-PP-*	TriggerJet Spray Gun; Polypropylene . . . . .	41.80
	4688	Brass . . . . .	70.98
	6466	Brass, with Non-locking Trigger . . . . .	76.51
	6104	Brass . . . . .	70.33
	6590	Brass, with Non-locking Trigger . . . . .	71.41
<b>SPRAY GUN ACCESSORIES</b>			
	3056	Garden Hose Adapter for No. 46 Trigger Valve, Brass . . . . .	15.58
	4676-3/4	Outlet Adapter, Brass, for #12 GunJet Spray Guns . . . . .	17.85
	7029	(F) x ½" NPT (M) Inlet Adapter with Gasket Brass for #42 and #43 GunJet Spray Guns . . . . .	19.21
	7599-1/4-ENP, -3/8-ENP	Inlet Adapter for #23 GunJet, Brass . . . . .	6.50
	11740B	¾" Garden Hose Swivel, Brass . . . . .	53.99
	11990-6	¼" NPS Swivel, Brass . . . . .	25.68
	11990-18, -19	½" NPT (M) Swivel, Brass, for #43 and #143 GunJet Spray Guns . . . . .	54.58
	13212-3/8, -1/2	Garden Hose Adapter . . . . .	8.08
<b>ADJUSTABLE CONEJET® TIPS</b>			
	38720-PPB-X8,-X12,-X18,-X26	Adjustable ConeJet Tip . . . . .	9.82
	5500-PPB-*	Polypropylene . . . . .	13.30
	5500-*	Brass . . . . .	29.11
	5780-AX	Brass . . . . .	44.98
	12430-AY-HSS	Brass with Hardened Stainless Steel Orifice and Core Insert . . . . .	85.78

\*- Specify Tip Capacity

# GunJet® SPRAY GUNS AND ACCESSORIES

**U.S.  
DOLLARS**

**TRIGGER VALVE EXTENSIONS—  
Less Tip, Strainer and Cap**

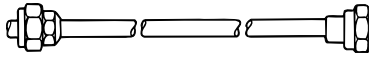

7715

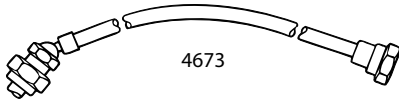

4673



6671

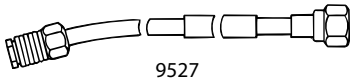

9527

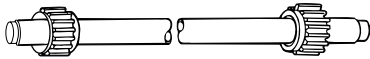

22665

7715-8	8"/20 cm Straight Extension . . . . .	\$ 17.86
7715-18	18"/46 cm Straight Extension . . . . .	22.50
7715-24	24"/61 cm Straight Extension . . . . .	24.30
7715-30	30"/76 cm Straight Extension . . . . .	29.11
7715-36	36"/91 cm Straight Extension . . . . .	30.74
7715-48	48"/122 cm Straight Extension . . . . .	37.23
4673-8	8"/20 cm Curved Extension with Adjustable Body . . . . .	29.87
4673-18	18"/46 cm Curved Extension with Adjustable Body . . . . .	34.74
4673-24	24"/61 cm Curved Extension with Adjustable Body . . . . .	36.50
4673-30	30"/76 cm Curved Extension with Adjustable Body . . . . .	40.17
4673-36	36"/91 cm Curved Extension with Adjustable Body . . . . .	42.96
4673-48	48"/122 cm Curved Extension with Adjustable Body . . . . .	49.16
6671-8	8"/20 cm Curved Extension with Fixed Nozzle Body . . . . .	20.87
6671-18	18"/46 cm Curved Extension with Fixed Nozzle Body . . . . .	25.43
6671-24	24"/61 cm Curved Extension with Fixed Nozzle Body . . . . .	26.29
6671-30	30"/76 cm Curved Extension with Fixed Nozzle Body . . . . .	29.71
6671-36	36"/91 cm Curved Extension with Fixed Nozzle Body . . . . .	33.80
6671-48	48"/122 cm Curved Extension with Fixed Nozzle Body . . . . .	39.08
9527-8	8"/20 cm High Pressure Curved Extension . . . . .	56.21
9527-18	18"/46 cm High Pressure Curved Extension . . . . .	65.04
9527-24	24"/61 cm High Pressure Curved Extension . . . . .	66.64
9527-36	36"/91 cm High Pressure Curved Extension . . . . .	86.38
9527-48	48"/122 cm High Pressure Curved Extension . . . . .	93.45
22665-15-PP	TriggerJet Extension (15"/38 cm) . . . . .	16.85
22665-24-PP	TriggerJet Extension (24"/61 cm) . . . . .	28.04

# TeeJet® TECHNOLOGIES

## TANK AGITATION AND CONTAINER RINSING NOZZLES

**U.S.  
DOLLARS**

**JET AGITATORS & EDUCTORS**



6290

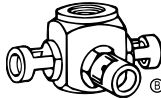

6290SC

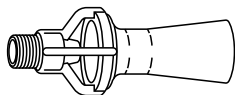

Y33180-PP, Y9270-PP & 46550-PP

6290-*	Brass . . . . .	\$ 66.29
6290-SS	Stainless Steel . . . . .	168.21
6290SC-*	With Suction Caps, Brass . . . . .	60.35
6290SC-SS	With Suction Caps, Stainless Steel . . . . .	240.20
Y33180-PP and Y9270-PP	Eductor Nozzle. . . . .	92.18
46550-1/4-PP	Eductor Nozzle. . . . .	64.68
46550-1-1/2-PP	Eductor Nozzle. . . . .	170.84

**TANK & CONTAINER RINSING NOZZLES**

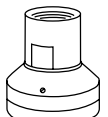

55270

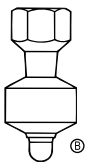

D41892

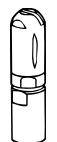

23240

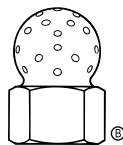

VSM

(B)55270-1/2-11-POM	Tank Rinsing Nozzle . . . . .	124.66
(B)55270-3/4-18-POM	Tank Rinsing Nozzle . . . . .	124.66
D41892-(B)1/2-POM-6	Rotary Tank Rinsing Nozzle . . . . .	272.62
23240-3-316SS-5.7-316SS	Container Rinsing Nozzle . . . . .	977.93
23240-3-316SS-7-316SS	Container Rinsing Nozzle . . . . .	1,017.19
(B)VSM-1/2	Nylon 28, 44, 90 Container Rinsing Nozzle . . . . .	60.75

# TeeJet<sup>®</sup> TECHNOLOGIES LINE STRAINERS

## AA122 LINE STRAINERS

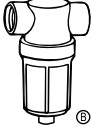
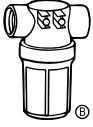
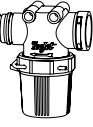
	STRAINER NO.	PIPE CONN. NPT (F)	MATERIAL		U.S. DOLLARS (STRAINER & SCREEN)	SCREEN NO.	MESH	U.S. DOLLARS (SCREEN ONLY)		
			HEAD	BOWL						
 AA122	AA(B)122-1/2-PP	1/2"	Polypropylene	Polypropylene	\$ 26.69	CP23174-1-304SS	16	\$9.27		
	AA(B)122ML-1/2-PP (B)37270-122-1/2-PP					CP23174-2-304SS	30			
 37270-122-PP						29.08	CP23174-7-304SS	200	17.04	
						105.96				
 AA122ML	AA(B)122-3/4-PP	3/4"					26.69	CP45102-3-SSPP	50	10.22
	AA(B)122ML-3/4-PP						29.08	CP45102-4-SSPP	80	
	(B)37270-122-3/4-PP						105.96	CP45102-5-SSPP	100	
 AA122ML-QC	AA122ML-QC	Quick Connect					54.33	CP45102-3-SSPP	50	10.22
								CP45102-4-SSPP	80	
								CP45102-5-SSPP	100	

## AA124A LINE STRAINERS

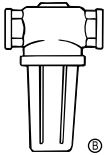
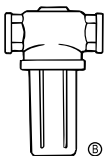
	STRAINER NO.	PIPE CONN. NPT (F)	MATERIAL		U.S. DOLLARS (STRAINER & SCREEN)	SCREEN NO.	MESH	U.S. DOLLARS (SCREEN ONLY)	
			HEAD	BOWL					
 AA124A	AA(B)124A-3/4-I	3/4"	Nylon		\$ 137.12	CP16903-1-SSPP	16	\$ 19.80	
	AA(B)124A-3/4-AL					Aluminum	30		
	AA(B)124A-1-I	1"			Cast Iron	50			
AA(B)124A-1-AL	Aluminum				80				
 AA124	AA(B)124-1-1/4-I	1 1/4"			Cast Iron	222.43	CP15941-1-SSPP	16	27.88
	AA(B)124-1-1/4-AL				Aluminum	211.64	CP15941-2-SSPP	30	
	AA(B)124-1-1/2-I	1 1/2"			Cast Iron	213.87	CP15941-3-SSPP	50	
	AA(B)124-1-1/2-AL				Aluminum	211.64	CP15941-4-SSPP	80	
	AA(B)124-2-I	2"			Cast Iron	485.24	CP14634-1-SS	16	92.78
	AA(B)124-2-AL				Aluminum	485.24	CP14634-2-SS	30	
	AA(B)124-2-1/2-I	2 1/2"	Cast Iron	485.24	CP14634-3-SS	50			
	AA(B)124-2-1/2-AL		Aluminum	485.24	CP14634-4-SS	80			

# TeeJet<sup>®</sup> TECHNOLOGIES LINE STRAINERS

## AA124ML LINE STRAINERS WITH MOUNTING LUGS

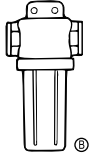
	STRAINER NO.	PIPE CONN. NPT (F)	MATERIAL		U.S. DOLLARS (STRAINER & SCREEN)	SCREEN NO.	MESH	U.S. DOLLARS (SCREEN ONLY)										
			HEAD	BOWL														
 AA124ML	AA(B)124ML-3/4-AL	¾"	Aluminum	Nylon	\$ 159.63	CP16903-1-SSPP*	16	\$ 19.80										
	AA(B)124ML-1-AL	1"				CP16903-3-SSPP*	30		CP16903-4-SSPP*	50	CP16903-5-SSPP*	80						
	AA(B)124ML-1-1/4-AL	1¼"				CP15941-1-SSPP*	16		CP15941-2-SSPP*	30	CP15941-3-SSPP*	50	CP15941-4-SSPP*	80				
	AA(B)124ML-1-1/2-AL	1½"			245.53	Nylon	245.53	CP15941-1-SSPP*	16	CP15941-2-SSPP*	30	CP15941-3-SSPP*	50	CP15941-4-SSPP*	80			
	AA(B)124ML-2-AL	2"						567.20	Nylon	567.20	CP14634-1-SS	16	CP14634-2-SS	30	CP14634-3-SS	50	CP14634-4-SS	80
	AA(B)124ML-2-1/2-AL	2½"									CP14634-1-SS	16	CP14634-2-SS	30	CP14634-3-SS	50	CP14634-4-SS	80

\*With Polypropylene frame

## AA126-PP FLUSH-OUT STRAINER WITH MOUNTING LUGS

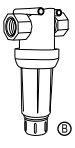
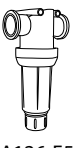
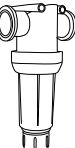
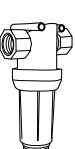
	STRAINER NO.	PIPE CONN. NPT (F)	MATERIAL		U.S. DOLLARS (STRAINER & SCREEN)	SCREEN NO.	MESH	U.S. DOLLARS (SCREEN ONLY)													
			HEAD	BOWL																	
 AA126-3 or 4	AA126ML-F50	50 Series Flange	Polypropylene	Polypropylene	\$ 49.26	CP16903-1-SSPP*	16	\$ 19.80													
	 AA126-F50	AA(B)126ML-3				¾" NPT	CP16903-3-SSPP*		30	CP16903-4-SSPP*	50	CP16903-5-SSPP*	80	CP16903-6-SSPP*	100	CP16903-7-SSPP*	200				
 AA126-F75		AA(B)126ML-4				1" NPT	Polypropylene		Polypropylene	100.79	CP15941-1-SSPP*	16	27.88								
	 AA126-5 or 6	AA126ML-F75				75 Series Flange					CP15941-2-SSPP*	30		CP15941-3-SSPP*	50	CP15941-4-SSPP*	80	CP15941-5-SSPP*	100	CP15941-6-SSPP*	120
AA(B)126ML-5		1¼" NPT				100.79					Polypropylene	100.79		CP15941-1-SSPP*	16	27.88					
AA(B)126ML-6		1½" NPT												CP15941-2-SSPP*	30		CP15941-3-SSPP*	50	CP15941-4-SSPP*	80	CP15941-5-SSPP*
			CP15941-1-SSPP*	16	CP15941-2-SSPP*			30						CP15941-3-SSPP*	50		CP15941-4-SSPP*	80	CP15941-5-SSPP*	100	CP15941-6-SSPP*
	CP15941-1-SSPP*		16	CP15941-2-SSPP*	30			CP15941-3-SSPP*						50	CP15941-4-SSPP*		80	CP15941-5-SSPP*	100	CP15941-6-SSPP*	120

## AA124A SELF-CLEANING LINE STRAINERS

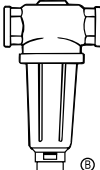

	STRAINER NO.	PIPE CONN. NPT (F)	MATERIAL		U.S. DOLLARS (STRAINER & SCREEN)	SCREEN NO.	MESH	U.S. DOLLARS (SCREEN ONLY)		
			HEAD	BOWL						
 AA124A-SC	AA(B)124A-3/4SC-AL	¾"	Aluminum	Nylon	\$ 170.04	CP12285-1-SS	16	\$ 30.47		
	AA(B)124A-1SC-AL	1"				CP12285-4-SS	30		CP12285-2-SS	50
	AA(B)124-1-1/4SC-AL	1¼"	Aluminum	Nylon	294.48	CP12290-1-SS	16	53.28		
	AA(B)124-1-1/2SC-AL	1½"				CP12290-2-SS	30		CP12290-3-SS	50

# TeeJet<sup>®</sup> TECHNOLOGIES LINE STRAINERS

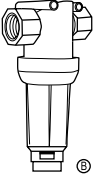
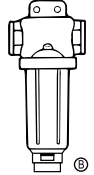
## SELF-CLEANING LINE STRAINERS WITH MOUNTING LUGS

	STRAINER NO.	PIPE CONN. NPT (F)	MATERIAL		U.S. DOLLARS (STRAINER & SCREEN)	SCREEN NO.	MESH	U.S. DOLLARS (SCREEN ONLY)
			HEAD	BOWL				
 AA126ML-3 or 4SC	AA(B)126MLSC-3	3/4"	Polypropylene		\$ 76.14	CP12285-1-SS	16	\$ 30.47
	AA(B)124ML-3/4SC-AL		Aluminum	Nylon	198.66			
	AA(B)126MLSC-4	1"	Polypropylene		76.14	CP12285-2-SS	50	
	AA(B)124ML-1SC-AL		Aluminum	Nylon	198.66	CP12285-3-SS	80	
 AA124ML-SC	AA126MLSC-F50	Flange	Polypropylene		76.14	CP12285-6-SS	100	
	AA(B)126MLSC-5	1 1/4"	Polypropylene		127.69	CP12290-1-SS	16	
	AA(B)124ML-1-1/4SC-AL		Aluminum	Nylon	341.58	CP12290-2-SS		
	AA(B)126MLSC-6	1 1/2"	Polypropylene		127.69	CP12290-3-SS	50	
	AA(B)124ML-1-1/2SC-AL		Aluminum	Nylon	341.58	CP12290-4-SS	80	
AA126MLSC-F75	Flange	Polypropylene		127.69	CP12290-8-SS	100		

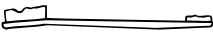
# TeeJet<sup>®</sup> TECHNOLOGIES SPRAYER CALIBRATION AND ACCESSORIES

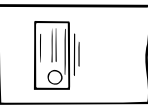
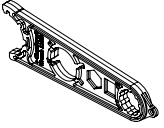
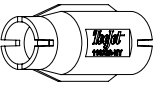
				U.S. DOLLARS
<b>CALIBRATION ITEMS</b>				
 CP20016-NY	 CP24034A-PP	CP24034A-PP TeeJet Calibration Container..... CP20016-NY TeeJet Cleaning Brush.....		\$ 61.44 13.63
<b>SPRAY CHECK PAPERS</b>				
 20301-	20301-1N Water Sensitive Spray Paper 1" x 3" Cards; 50 Cards/Pkg ..... 20301-2N Water Sensitive Spray Paper 2" x 3" Cards; 50 Cards/Pkg ..... 20301-3N Water Sensitive Spray Paper 1" x 20" Strips; 25 Strips/Pkg .....			64.53 107.15 199.81
<b>ACCESSORIES</b>				
 CP116231-NYB	 CP116232-NY	CP116231-NYB e-ChemSaver <sup>®</sup> Wrench ..... CP116232-NY Quick TeeJet <sup>®</sup> Cap Tool .....		8.24 10.26

PART NO.	DESCRIPTION	U.S. DOLLARS	PART NO.	DESCRIPTION	U.S. DOLLARS
AB115880*-KIT	SPARE PARTS KIT	\$ 74.16	AB530M-2-KIT	REPAIR KIT, 530M 2-WAY	\$ 82.10
AB115880*-FR-KIT	FIELD REPAIR KIT	201.02	AB55140-30L-KIT	REPAIR KIT	21.90
AB11990-14/16-KIT	REPAIR KIT, SWIVEL	12.70	AB55140-30L-VI-KIT	FKM REPAIR KIT	30.33
AB11990-17/19-KIT	REPAIR KIT, SWIVEL	14.33	AB55295-1-KIT	SPARE PARTS KIT, 55280-1	74.16
AB11990-20/21-KIT	REPAIR KIT, SWIVEL	12.70	AB55295-2-KIT	SPARE PARTS KIT, 55280-2	74.16
AB11990-6/13-KIT	REPAIR KIT, SWIVEL	12.94	AB55295-4-KIT	SPARE PARTS KIT, 55280-4	74.16
AB11990-60/65-KIT	REPAIR KIT, SWIVEL	5.70	AB55300-1-KIT	AIR CHEMSAVER, BODY REPAIR KIT	34.53
AB122ML-QC-VI-KIT	122ML SPARE PARTS KIT	20.07	AB55300-2-KIT	AIR CHEMSAVER, PISTON REPAIR KIT	35.76
AB12328-KIT	SPARE PARTS KIT, 12328	54.24	AB55300-KIT	AIR CHEMSAVER, BODY REPAIR KIT	30.22
AB12690-KIT	REPAIR KIT, 12690	31.11	AB56720-KIT	SPARE PARTS KIT	31.89
AB126ML-50-EPR-KIT	126 REPAIR KIT	8.08	AB60-SS-KIT	SPARE PARTS KIT, SS	61.68
AB126ML-50-VI-KIT	126 REPAIR KIT	20.52	AB60W-KIT	SPARE PARTS KIT 60W	41.78
AB126ML-F75-EPR-KIT	126 REPAIR KIT	11.05	AB6104-KIT	REPAIR KIT, TRIGGER VALVE	16.21
AB126ML-F75-VI-KIT	126 REPAIR KIT	25.09	AB6466-KIT	PARTS KIT, TRIGGER TEEJET	16.21
AB12AS-KIT	SUPER REPAIR KIT, 12A	45.84	AB6590-KIT	PARTS KIT, TRIGGER VALVE	16.21
AB12S-AL-KIT	SUPER PARTS KIT, 12-AL	52.78	AB6815-300-KIT	REPAIR KIT, 6815	21.06
AB12S-KIT	SUPER REPAIR KIT, 12	45.84	AB6815-50-KIT	REPAIR KIT 6815-50LB	30.85
AB13833-KIT	REPAIR KIT 13833	40.80	AB6815-700-KIT	REPAIR KIT, 6815	22.46
AB13845-KIT	SPARE PARTS KIT GUNJET	38.79	AB6815-AL-700-KIT	REPAIR KIT, 6815-AL	20.63
AB144P-1-3-KIT	REPAIR KIT	36.38	AB6815-AL-HSS-1200-KIT	REPAIR KIT, 6815-AL-HSS	40.41
AB145H-1-KIT	PARTS KIT DIRECTOVALVE	94.53	AB6815-AL-HSS-300-KIT	REPAIR KIT, 6815-AL-HSS	28.58
AB145H-VI-KIT	PARTS KIT DIRECTOVALVE	107.97	AB6815-AL-HSS-700-KIT	REPAIR KIT, 6815-AL-HSS	33.67
AB15950-KIT	SPARE PARTS KIT	38.50	AB6815G-300-KIT	REPAIR KIT, 6815G	27.88
AB16027-KIT	SPARE PARTS KIT	20.61	AB6815G-700-KIT	REPAIR KIT, 6815G	33.20
AB21550-KIT	SPARE PARTS KIT	24.09	AB6815G-AL-300-KIT	REPAIR KIT, 6815G-AL	26.74
AB23240-316SS-316SS-KIT	SPARE PARTS KIT	314.55	AB6815G-AL-700-KIT	REPAIR KIT, 6815G-AL	31.92
AB23600-1-KIT	METERJET REPAIR KIT	38.73	AB6815G-AL-HSS-300-KIT	REPAIR KIT, 6815G-AL-HSS	69.02
AB23600-2-KIT	METERJET REPAIR KIT	38.73	AB6815G-AL-HSS-700-KIT	REPAIR KIT, 6815G-AL-HSS	74.13
AB23623-31-KIT	SPARE PARTS KIT	65.45	AB6815G-HSS-300-KIT	REPAIR KIT, 6815G-HSS	69.02
AB23624-30L-1/4-KIT	SPARE PARTS KIT	61.44	AB6815G-HSS-700-KIT	REPAIR KIT, 6815G-HSS	74.13
AB23770-SS-KIT	SPARE PARTS KIT, SS	38.40	AB6815-HSS-1200-KIT	REPAIR KIT, 6815-HSS	44.12
AB23990-KIT	SPARE PARTS KIT	8.63	AB6815-HSS-300-KIT	REPAIR KIT, 6815-HSS	31.20
AB23H-SS-KIT	SPARE PARTS KIT GUNJET	43.12	AB6815-HSS-700-KIT	REPAIR KIT, 6815-HSS	36.84
AB23L-7676-KIT	PARTS REPAIR KIT	26.00	AB9840-KIT	PARTS KIT, PR.REL.VLV	27.11
AB23L-SS-KIT	SPARE PARTS KIT GUNJET	38.47	AB98450-KIT	ROLLOVER VALVE PARTS KIT	14.66
AB23PC-KIT	SPARE PARTS KIT GUNJET	14.77	AB98499-KIT	430 ACC MOUNTING KIT	10.22
AB24055-KIT	SPARE PARTS KIT	9.84	ABAIXR-KIT	AIXR O-RING 25PCS	23.61
AB25-AL-KIT	SUPER REPAIR KIT, 2AL	62.46	ABCK43A-AL-KIT	CONVERSION KIT AL.	31.61
AB25-KIT	SUPER REPAIR KIT, 2	54.91	ABCK43A-KIT	CONVERSION KIT BR.	31.61
AB30-20940-KIT	SPARE PARTS KIT	60.70	ABCK43-AL-KIT	CONVERSION KIT AL.	38.34
AB30A-50736-KIT	A VERSION GUNJET KIT	60.70	ABCK43-KIT	CONVERSION KIT BR.	38.34
AB30A-VI-KIT	A VERSION GUNJET KIT	40.85	ABPW4000A-KIT	SPARE PARTS KIT	29.57
AB30AW-KIT	A VERSION GUNJET KIT	23.74	ABPW4000AS-KIT	REPAIR KIT	29.57
AB30L-KIT	30L GUNJET REPAIR KIT	17.44	ABPW4000ASW-KIT	REPAIR KIT	29.57
AB30L-VI-KIT	30L FKM REPAIR KIT	40.85	ABPW4000AW-KIT	SPARE PARTS KIT	29.57
AB30-VI-KIT	GUNJET REPAIR KIT	40.85	PK-AB12A-KIT	REPAIR KIT	30.94
AB30W-KIT	GUNJET REPAIR KIT	23.74	PK-AB12-AL-KIT	REPAIR KIT	44.35
AB31-9525-KIT	SPARE PARTS KIT, GUNJET	21.73	PK-AB12-KIT	REPAIR KIT	30.94
AB31-KIT	SPARE PARTS KIT, GUNJET	18.42	PK-AB143-AL-KIT	REPAIR KIT	44.03
AB343M-2-PP-KIT	SPARE PARTS KIT	53.07	PK-AB143-KIT	REPAIR KIT	44.03
AB343M-3-PP-KIT	SPARE PARTS KIT	63.63	PK-AB144-1-3-KIT	REPAIR KIT	48.03
AB344-2-KIT	344M-2 REPAIR KIT	54.33	PK-AB144-1-KIT	REPAIR KIT	41.86
AB344-3-KIT	344M-3 REPAIR KIT	65.60	PK-AB144-1-VI-KIT	REPAIR KIT, FKM	62.59
AB344AE-KIT	344A & B REPAIR KIT	82.19	PK-AB144A-1-3-KIT	REPAIR KIT	48.03
AB346B-KIT	SPARE PARTS KIT	73.06	PK-AB144A-1-3-VI-KIT	REPAIR KIT, FKM	68.82
AB346M-2-PP-KIT	SPARE PARTS KIT	75.07	PK-AB144A-1-KIT	REPAIR KIT	41.86
AB346M-3-PP-KIT	SPARE PARTS KIT	96.55	PK-AB144A-1-VI-KIT	REPAIR KIT, FKM	62.59
AB356-KIT	356 TRUN VLV KIT	100.76	PK-AB144P-1-KIT	REPAIR KIT	62.59
AB36-SS-KIT	REPAIR KIT, 36 VLV, SS	28.24	PK-AB145H-KIT	REPAIR KIT	75.35
AB430-KIT	PARTS KIT, 430	53.26	PK-AB17-KIT	REPAIR KIT	54.02
AB43-11767-KIT	SPARE PARTS KIT, GUNJET	37.94	PK-AB18-AL-KIT	REPAIR KIT	34.01
AB43-12605-KIT	SPARE PARTS KIT, GUNJET	37.94	PK-AB18-KIT	REPAIR KIT	30.94
AB43B-KIT	SPARE PARTS KIT, GUNJET	12.95	PK-AB22650-PP-KIT	REPAIR KIT	14.41
AB43BS-KIT	SUPER REPAIR KIT 43B	77.91	PK-AB22670-PP-KIT	REPAIR KIT	19.31
AB43C-KIT	SPARE PARTS KIT, GUNJET	12.95	PK-AB23120-60-VI-KIT	REPAIR KIT	25.63
AB43CS-KIT	SUPER REPAIR KIT 43C	77.91	PK-AB23120A-KIT	REPAIR KIT	30.07
AB43D-KIT	SPARE PARTS KIT, GUNJET	12.95	PK-AB23120-KIT	REPAIR KIT	25.63
AB43DS-KIT	SUPER REPAIR KIT 43D	77.91	PK-AB23H-KIT	REPAIR KIT	35.45
AB460B-KIT	SPARE PARTS KIT	87.49	PK-AB23L-KIT	REPAIR KIT	31.34
AB47-11767-KIT	SPARE PARTS KIT GUNJET	75.03	PK-AB25660-KIT	REPAIR KIT	28.14
AB47-12605-KIT	SPARE PARTS KIT	75.03	PK-AB2A-AL-KIT	REPAIR KIT	26.64
AB47-KIT	SPARE PARTS KIT 47	78.42	PK-AB2A-KIT	REPAIR KIT	24.32
AB47-SS-KIT	SPARE PARTS KIT 47	78.42	PK-AB2-AL-KIT	REPAIR KIT	26.64
AB530EC-2-KIT	REPAIR KIT, 530EC 2-WAY	70.36	PK-AB2-KIT	REPAIR KIT	30.29
AB530EC-3-KIT	REPAIR KIT, 530EC 3-WAY	81.54			



**SPARE PARTS KITS**

PART NO.	DESCRIPTION	U.S. DOLLARS	PART NO.	DESCRIPTION	U.S. DOLLARS
PK-AB30-KIT	REPAIR KIT	\$ 28.91	PK-AB60-KIT	REPAIR KIT	\$ 54.38
PK-AB30L-PP-KIT	REPAIR KIT	23.95	PK-AB6815-300-KIT	REPAIR KIT	24.09
PK-AB31-KIT	REPAIR KIT	26.84	PK-AB6815-AL-300-KIT	REPAIR KIT	22.71
PK-AB36-KIT	REPAIR KIT	31.00	PK-AB6B-KIT	REPAIR KIT	32.18
PK-AB43-AL-KIT	REPAIR KIT	58.38	PK-AB8460-50-KIT	REPAIR KIT 8460-*-50	34.41
PK-AB43-KIT	REPAIR KIT	58.38	PK-AB8460-KIT	REPAIR KIT	34.41
PK-AB4688-KIT	REPAIR KIT	22.27			



**SALES LITERATURE**

**U.S. DOLLARS**

LI-PL23FD	Price List, Fluid Delivery USD .....	\$ 0.00
LI-PL23FD-EURO	Price List, Fluid Delivery Euro .....	0.00
LI-PL23PF	Price List, Precision Farming USD .....	0.00
LI-PL23PF-EURO	Price List, Precision Farming Euro .....	0.00
LI-TJ112-R5	Bulletin, AIXR Tips US .....	0.00
LI-TJ113-R2	Bulletin, Flow Back Valves .....	0.00
LI-TJ114-R4	Bulletin, TTI .....	0.00
LI-TJ123-R5	Bulletin, TwinJet® US .....	0.00
LI-TJ134-R2	Bulletin, AI3070 US .....	0.00
LI-TJ137	Bulletin, QJ PTC Fittings .....	0.00
LI-TJ147-R1	Bulletin, QJS Nozzle Bodies .....	0.00
LI-TJ157	Bulletin, AI3070 Article .....	0.00
LI-TJ169	Bulletin, TXR US .....	0.00
LI-TJ169M	Bulletin, TXR Metric .....	0.00
LI-TJ173-R1	Bulletin, Spray Tank Demo .....	0.00
LI-TJ191	Bulletin, QJ370 Nozzle Body .....	0.00
LI-TJ196-R2	Bulletin, QJ-VR & PTC-VR Tips US .....	0.00
LI-TJ201	Bulletin, TTI60 US .....	0.00
LI-TJ202-R1	Bulletin, SJ3-VR US .....	0.00
LI-TJ203-R1	Bulletin, SJ7A-VR US .....	0.00
LI-TJ204	Bulletin, DynaJet Tips .....	0.00
LI-TJ207-R5	Bulletin, TTI Xtend .....	0.00
LI-TJ208-R5	Bulletin, TTI Engenia .....	0.00
LI-TJ212-R5	Bulletin, PWM Spray Tip Selection, US Units .....	0.00
LI-TJ212M-R5	Bulletin, PWM Spray Tip Selection, Metric Units .....	0.00
LI-TJ222-R2	Bulletin, Enlist Tips .....	0.00
LI-TJ227-R1	Bulletin, 530 Manifold .....	0.00
LI-TJ334-R3	Bulletin, Liberty .....	0.00
LI-TJ369-R1	Bulletin, Spray Select .....	0.00
LI-TJ371-R1	Bulletin, PWM Spray Tip Selection, Turf, US Units .....	0.00
LI-TJ371M-R1	Bulletin, PWM Spray Tip Selection, Turf, Metric Units .....	0.00
LI-TJ378-R1	Tank Sticker, US, 20", ISO Standard .....	0.00
LI-TJ378M-R1	Tank Sticker, Metric, 50 cm, ISO Standard .....	0.00
LI-TJ384-R1	Bulletin, Droplet Size & Rate Chart, US, ISO Standard .....	0.00
LI-TJ405-R1	Bulletin, AccuPulse® TwinJet® Tips US Units .....	0.00
LI-TJ419	Bulletin, Droplet Size & Rate Chart, US, 15", ISO Standard .....	0.00
LI-TJ420	Tank Sticker, Droplet Size & Rate Chart, US, 15", ISO Standard .....	0.00
LI-TJ428	Tavium Application Updates .....	0.00



# COMPREHENSIVE LIST

PART NO.	DESCRIPTION	U.S.DOLLARS	PART NO.	DESCRIPTION	U.S.DOLLARS
1/2ATW-AL100	STRAINER,ALUMINUM	\$ 114.57	1/4B-SS10-10W	WHIRLJET NOZ.,ST.STL	\$ 64.73
1/2ATW-AL16	STRAINER,ALUMINUM	114.57	1/4B-SS10-15W	WHIRLJET NOZ.,ST.STL	64.73
1/2ATW-AL200	STRAINER,ALUMINUM	114.57	1/4B-SS15	WHIRLJET NOZ.,ST.STL	61.38
1/2ATW-AL30	STRAINER,ALUMINUM	114.57	1/4B-SS15-15W	WHIRLJET NOZ.,ST.STL	64.73
1/2ATW-AL50	STRAINER,ALUMINUM	114.57	1/4B-SS2	WHIRLJET NOZ.,ST.STL	61.38
1/2ATW-AL80	STRAINER,ALUMINUM	114.57	1/4B-SS2-2W	WHIRLJET NOZ.,ST.STL	64.73
1/2ATW-B100	STRAINER,BRASS	145.77	1/4B-SS2-3W	WHIRLJET NOZ.,ST.STL	64.73
1/2ATW-B16	STRAINER,BRASS	145.77	1/4B-SS2-5W	WHIRLJET NOZ.,ST.STL	64.73
1/2ATW-B200	STRAINER,BRASS	145.77	1/4B-SS3	WHIRLJET NOZ.,ST.STL	61.38
1/2ATW-B30	STRAINER,BRASS	145.77	1/4B-SS3-3W	WHIRLJET NOZ.,ST.STL	64.73
1/2ATW-B50	STRAINER,BRASS	145.77	1/4B-SS3-8W	WHIRLJET NOZ.,ST.STL.	64.73
1/2ATW-B80	STRAINER,BRASS	145.77	1/4B-SS5	WHIRLJET NOZ.,ST.STL	61.38
1/2K-120	FLOODJET NOZ.,BRASS	27.79	1/4B-SS5-10W	WHIRLJET NOZ.,ST.STL	64.73
1/2K-40	FLOODJET NOZ.,BRASS	27.79	1/4B-SS5-15W	WHIRLJET NOZ.,ST.STL	64.73
1/2K-50	FLOODJET NOZ.,BRASS	27.79	1/4B-SS5-5W	WHIRLJET NOZ.,ST.STL	64.73
1/2K-60	FLOODJET NOZ.,BRASS	27.79	1/4B-SS5-8W	WHIRLJET NOZ.,ST.STL.	64.73
1/2K-70	FLOODJET NOZ.,BRASS	27.79	1/4B-SS8	WHIRLJET NOZ.,ST.STL	61.38
1/2K-80	FLOODJET NOZ.,BRASS	27.79	1/4B-SS8-10W	WHIRLJET NOZ.,ST.STL	64.73
1/2K-90	FLOODJET NOZ. BRASS	27.79	1/4K-10	FLOODJET NOZ.,BRASS	12.45
1/2K-SS120	FLOODJET NOZ.,ST.STL	46.67	1/4K-12	FLOODJET NOZ.,BRASS	12.45
1/2K-SS40	FLOODJET NOZ.,ST.STL	46.67	1/4K-15	FLOODJET NOZ.,BRASS	12.45
1/2K-SS50	FLOODJET NOZ.,ST.STL	46.67	1/4K-18	FLOODJET NOZ.,BRASS	12.45
1/2K-SS60	FLOODJET NOZ.,ST.STL	46.67	1/4K-2	FLOODJET NOZ.,BRASS	12.45
1/2K-SS70	FLOODJET NOZ.,ST.STL	46.67	1/4K-2.5	FLOODJET NOZ.,BRASS	12.45
1/2K-SS80	FLOODJET NOZ.,ST.STL	46.67	1/4K-20	FLOODJET NOZ.,BRASS	12.45
1/2K-SS90	FLOODJET NOZ. ST.STL	46.67	1/4K-22	FLOODJET NOZ.,BRASS	12.45
1/2XP40L-VP	XP BOOMJET NOZZLE	89.33	1/4K-24	FLOODJET NOZ.,BRASS	12.45
1/2XP40R-VP	XP BOOMJET NOZZLE	89.33	1/4K-27	FLOODJET NOZ.,BRASS	12.45
1/2XP80L-VP	XP BOOMJET NOZZLE	89.33	1/4K-3	FLOODJET NOZ.,BRASS	12.45
1/2XP80R-VP	XP BOOMJET NOZZLE	89.33	1/4K-5	FLOODJET NOZ.,BRASS	12.45
1/4-625	EYELET CONN.,BRASS	12.99	1/4K-7.5	FLOODJET NOZ.,BRASS	12.45
1/4A-1	WHIRLJET NOZ.,BRASS	20.63	1/4K-SS10	FLOODJET NOZ.,ST.STL	28.79
1/4A-3	WHIRLJET NOZ.,BRASS	20.63	1/4K-SS12	FLOODJET NOZ.,ST.STL	28.79
1/4A-5	WHIRLJET NOZ.,BRASS	20.63	1/4K-SS15	FLOODJET NOZ.,ST.STL	28.79
1/4AB-10	CHECK VALVE,BRASS	70.44	1/4K-SS18	FLOODJET NOZ.,ST.STL	28.79
1/4AB-20	CHECK VALVE,BRASS	70.44	1/4K-SS2	FLOODJET NOZ.,ST.STL	28.79
1/4AB-30	CHECK VALVE,BRASS	70.44	1/4K-SS2.5	FLOODJET NOZ.,ST.STL	28.79
1/4AB-40	CHECK VALVE,BRASS	70.44	1/4K-SS20	FLOODJET NOZ.,ST.STL	28.79
1/4AB-5	CHECK VALVE,BRASS	70.44	1/4K-SS22	FLOODJET NOZ.,ST.STL	28.79
1/4AB-SS10	CHECK VALVE,ST.STL.	138.57	1/4K-SS24	FLOODJET NOZ.,ST.STL	28.79
1/4AB-SS20	CHECK VALVE,ST.STL.	138.57	1/4K-SS27	FLOODJET NOZ.,ST.STL	28.79
1/4AB-SS30	CHECK VALVE,ST.STL.	138.57	1/4K-SS3	FLOODJET NOZ.,ST.STL	28.79
1/4AB-SS40	CHECK VALVE ST.STL.	138.57	1/4K-SS4	FLOODJET NOZ.,ST.STL	28.79
1/4AB-SS5	CHECK VALVE,ST.STL.	138.57	1/4K-SS5	FLOODJET NOZ.,ST.STL	28.79
1/4B-1	WHIRLJET NOZ.,BRASS	23.25	1/4K-SS7.5	FLOODJET NOZ.,ST.STL	28.79
1/4B-1-10	WHIRLJET NOZ.,BRASS	23.25	1/4KLC-18	FIELDJET NOZ.,BRASS	63.17
1/4B-10	WHIRLJET NOZ.,BRASS	23.25	1/4KLC-36	FIELDJET NOZ.,BRASS	63.17
1/4B-10-15W	WHIRLJET NOZ.,BRASS	28.03	1/4KLC-5	FIELDJET NOZ.,BRASS	63.17
1/4B-10-5W	WHIRLJET NOZ.,BRASS	28.03	1/4KLC-9	FIELDJET NOZ.,BRASS	63.17
1/4B-2	WHIRLJET NOZ.,BRASS	23.25	1/4KLC-SS18	FIELDJET NOZ.,ST.STL	103.34
1/4B-2-2W	WHIRLJET NOZ.,BRASS	28.03	1/4KLC-SS36	FIELDJET NOZ.,ST.STL	103.34
1/4B-2-5W	WHIRLJET NOZ.,BRASS	28.03	1/4KLC-SS5	FIELDJET NOZ.,ST.STL	103.34
1/4B-3-1W	WHIRLJET NOZ.,BRASS	28.03	1/4KLC-SS9	FIELDJET NOZ.,ST.STL	103.34
1/4B-3-8W	WHIRLJET NOZ.,BRASS	28.03	1/4MEG-0002	WASHJET NOZZLE HSS	11.54
1/4B-5	WHIRLJET NOZ.,BRASS	23.25	1/4MEG-0003	WASHJET NOZZLE,HSS	11.54
1/4B-5-10	WHIRLJET NOZ.,BRASS	23.25	1/4MEG-0004	WASHJET NOZZLE,HSS	11.54
1/4B-8	WHIRLJET NOZ.,BRASS	23.25	1/4MEG-0005	WASHJET NOZZLE,HSS	11.54
1/4B-8-15W	WHIRLJET NOZ.,BRASS	28.03	1/4MEG-0006	WASHJET NOZZLE,HSS	11.54
1/4B-8-5	WHIRLJET NOZ.,BRASS	23.25	1/4MEG-0007	WASHJET NOZZLE,HSS	11.54
1/4B-SS0.5-10W	WHIRLJET NOZ.,ST.STL.	64.73	1/4MEG-0008	WASHJET NOZZLE,HSS	11.54
1/4B-SS1	WHIRLJET NOZ.,ST.STL	61.38	1/4MEG-0009	WASHJET NOZZLE,HSS	11.54
1/4B-SS1-10W	WHIRLJET NOZ.,ST.STL	64.73	1/4MEG-0010	WASHJET NOZZLE,HSS	11.54
1/4B-SS1-15W	WHIRLJET NOZ.,ST.STL	64.73	1/4MEG-0015	WASHJET NOZZLE,HSS	11.54
1/4B-SS1-5W	WHIRLJET NOZ.,ST.STL	64.73	1/4MEG-0020	WASHJET NOZZLE,HSS	11.54



PART NO.	DESCRIPTION	U.S.DOLLARS	PART NO.	DESCRIPTION	U.S.DOLLARS
1/4MEG-0025	WASHJET NOZZLE,HSS	11.54	1/4MEG-5020	WASHJET NOZZLE,HSS	11.54
1/4MEG-0030	WASHJET NOZZLE,HSS	11.54	1/4MEG-6502	WASHJET NOZZLE,HSS	11.54
1/4MEG-0040	WASHJET NOZZLE,HSS	11.54	1/4MEG-6503	WASHJET NOZZLE,HSS	11.54
1/4MEG-0502	WASHJET NOZZLE,HSS	11.54	1/4MEG-6504	WASHJET NOZZLE,HSS	11.54
1/4MEG-0503	WASHJET NOZZLE,HSS	11.54	1/4MEG-6505	WASHJET NOZZLE,HSS	11.54
1/4MEG-0504	WASHJET NOZZLE,HSS	11.54	1/4MEG-6506	WASHJET NOZZLE,HSS	11.54
1/4MEG-0505	WASHJET NOZZLE,HSS	11.54	1/4MEG-6507	WASHJET NOZZLE,HSS	11.54
1/4MEG-0506	WASHJET NOZZLE,HSS	11.54	1/4MEG-6508	WASHJET NOZZLE,HSS	11.54
1/4MEG-0507	WASHJET NOZZLE,HSS	11.54	1/4MEG-6509	WASHJET NOZZLE,HSS	11.54
1/4MEG-0508	WASHJET NOZZLE,HSS	11.54	1/4MEG-6510	WASHJET NOZZLE,HSS	11.54
1/4MEG-0509	WASHJET NOZZLE,HSS	11.54	1/4MEG-6515	WASHJET NOZZLE,HSS	11.54
1/4MEG-0515	WASHJET NOZZLE,HSS	11.54	1/4MEG-6520	WASHJET NOZZLE,HSS	11.54
1/4MEG-0520	WASHJET NOZZLE,HSS	11.54	1/4Q-100	STRAINER,BRASS	25.41
1/4MEG-0525	WASHJET NOZZLE,HSS	11.54	1/4Q-200	STRAINER,BRASS	25.41
1/4MEG-0540	WASHJET NOZZLE,HSS	11.54	1/4Q-24	STRAINER,BRASS	25.41
1/4MEG-1501	WASHJET NOZZLE,HSS	11.54	1/4Q-50	STRAINER,BRASS	25.41
1/4MEG-1502	WASHJET NOZZLE,HSS	11.54	1/4TTJ02-VS	TURFJET	25.55
1/4MEG-1503	WASHJET NOZZLE,HSS	11.54	1/4TTJ04-VS	TURFJET	25.55
1/4MEG-1504	WASHJET NOZZLE,HSS	11.54	1/4TTJ05-VS	TURFJET	25.55
1/4MEG-1505	WASHJET NOZZLE,HSS	11.54	1/4TTJ06-VP	POLY TURFJET	13.22
1/4MEG-1506	WASHJET NOZZLE,HSS	11.54	1/4TTJ06-VS	TURFJET	25.55
1/4MEG-1507	WASHJET NOZZLE,HSS	11.54	1/4TTJ08-VP	POLY TURFJET	13.22
1/4MEG-1508	WASHJET NOZZLE,HSS	11.54	1/4TTJ08-VS	TURFJET	25.55
1/4MEG-1509	WASHJET NOZZLE,HSS	11.54	1/4TTJ10-VP	POLY TURFJET	13.22
1/4MEG-1510	WASHJET NOZZLE,HSS	11.54	1/4TTJ10-VS	TURFJET	25.55
1/4MEG-1515	WASHJET NOZZLE,HSS	11.54	1/4TTJ15-VP	POLY TURFJET	13.22
1/4MEG-1520	WASHJET NOZZLE,HSS	11.54	1/4TTJ15-VS	TURFJET	25.55
1/4MEG-1525	WASHJET NOZZLE,HSS	11.54	1/4XP10L-VP	XP BOOMJET NOZZLE	75.00
1/4MEG-2502	WASHJET NOZZLE,HSS	11.54	1/4XP10R-VP	XP BOOMJET NOZZLE	75.00
1/4MEG-25025	WASHJET NOZZLE,HSS	11.54	1/4XP20L-VP	XP BOOMJET NOZZLE	75.00
1/4MEG-2503	WASHJET NOZZLE,HSS	11.54	1/4XP20R-VP	XP BOOMJET NOZZLE	75.00
1/4MEG-2504	WASHJET NOZZLE,HSS	11.54	1/4XP25L-VP	XP BOOMJET NOZZLE	75.00
1/4MEG-2505	WASHJET NOZZLE,HSS	11.54	1/4XP25R-VP	XP BOOMJET NOZZLE	75.00
1/4MEG-2506	WASHJET NOZZLE,HSS	11.54	1/8A-SS1	WHIRLJET NOZ.,ST.STL	56.36
1/4MEG-25065	WASHJET NOZZLE,HSS	11.54	1/8B-10	WHIRLJET NOZ.,BRASS	19.01
1/4MEG-2507	WASHJET NOZZLE,HSS	11.54	1/8B-5	WHIRLJET NOZ.,BRASS	19.01
1/4MEG-2508	WASHJET NOZZLE,HSS	11.54	1/8BX-SS1-3W	WHIRLJET NOZ.ST.STL.	88.31
1/4MEG-2509	WASHJET NOZZLE,HSS	11.54	1/8K-.50	FLOODJET NOZ.,BRASS	7.92
1/4MEG-2510	WASHJET NOZZLE,HSS	11.54	1/8K-.75	FLOODJET NOZ.,BRASS	7.92
1/4MEG-2515	WASHJET NOZZLE,HSS	11.54	1/8K-1	FLOODJET NOZ.,BRASS	7.92
1/4MEG-2520	WASHJET NOZZLE,HSS	11.54	1/8K-1.5	FLOODJET NOZ.,BRASS	7.92
1/4MEG-2525	WASHJET NOZZLE,HSS	11.54	1/8K-10	FLOODJET NOZ.,BRASS	7.92
1/4MEG-4001	WASHJET NOZZLE,HSS	11.54	1/8K-12	FLOODJET NOZ.,BRASS	7.92
1/4MEG-4002	WASHJET NOZZLE,HSS	11.54	1/8K-15	FLOODJET NOZ.,BRASS	7.92
1/4MEG-4003	WASHJET NOZZLE,HSS	11.54	1/8K-18	FLOODJET NOZ.,BRASS	7.92
1/4MEG-4004	WASHJET NOZZLE,HSS	11.54	1/8K-2	FLOODJET NOZ.,BRASS	7.92
1/4MEG-4005	WASHJET NOZZLE,HSS	11.54	1/8K-2.5	FLOODJET NOZ.,BRASS	7.92
1/4MEG-4006	WASHJET NOZZLE,HSS	11.54	1/8K-20	FLOODJET NOZ.,BRASS	7.92
1/4MEG-4007	WASHJET NOZZLE,HSS	11.54	1/8K-3	FLOODJET NOZ.,BRASS	7.92
1/4MEG-4008	WASHJET NOZZLE,HSS	11.54	1/8K-4	FLOODJET NOZ.,BRASS	7.92
1/4MEG-4009	WASHJET NOZZLE,HSS	11.54	1/8K-5	FLOODJET NOZ.,BRASS	7.92
1/4MEG-4010	WASHJET NOZZLE,HSS	11.54	1/8K-7.5	FLOODJET NOZ.,BRASS	7.92
1/4MEG-4015	WASHJET NOZZLE,HSS	11.54	1/8K-SS.50	FLOODJET NOZ.,ST.STL	23.83
1/4MEG-4020	WASHJET NOZZLE,HSS	11.54	1/8K-SS.75	FLOODJET NOZ.,ST.STL	23.83
1/4MEG-4025	WASHJET NOZZLE,HSS	11.54	1/8K-SS1	FLOODJET NOZ.,ST.STL	23.83
1/4MEG-5003	WASHJET NOZZLE,HSS	11.54	1/8K-SS1.5	FLOODJET NOZ.,ST.STL	23.83
1/4MEG-5004	WASHJET NOZZLE,HSS	11.54	1/8K-SS10	FLOODJET NOZ.,ST.STL	23.83
1/4MEG-5005	WASHJET NOZZLE,HSS	11.54	1/8K-SS12	FLOODJET NOZ.,ST.STL	23.83
1/4MEG-5006	WASHJET NOZZLE,HSS	11.54	1/8K-SS15	FLOODJET NOZ.,ST.STL	23.83
1/4MEG-5007	WASHJET NOZZLE,HSS	11.54	1/8K-SS18	FLOODJET NOZ.,ST.STL	23.83
1/4MEG-5008	WASHJET NOZZLE,HSS	11.54	1/8K-SS2	FLOODJET NOZ.,ST.STL	23.83
1/4MEG-5009	WASHJET NOZZLE,HSS	11.54	1/8K-SS2.5	FLOODJET NOZ.,ST.STL	23.83
1/4MEG-5010	WASHJET NOZZLE,HSS	11.54	1/8K-SS20	FLOODJET NOZ.,ST.STL	23.83
1/4MEG-5015	WASHJET NOZZLE,HSS	11.54	1/8K-SS3	FLOODJET NOZ.,ST.STL	23.83



# COMPREHENSIVE LIST

PART NO.	DESCRIPTION	U.S.DOLLARS	PART NO.	DESCRIPTION	U.S.DOLLARS
1/8K-SS4	FLOODJET NOZ.,ST.STL	23.83	10565-NY	BR CORE ASBY NY SEAT	42.50
1/8K-SS5	FLOODJET NOZ.,ST.STL	23.83	10742A	1/4 DIAPH.CHECK VALVE BR	56.88
1/8K-SS7.5	FLOODJET NOZ.,ST.STL	23.83	10742A-1/8-VI	1/8-VI DIA CHECKVALVE VITON	60.87
1/8MEG-0002	WASHJET NOZZLE,HSS	10.96	10742A-AL	1/4 DIAPH.CHECK VALVE AL	54.82
1/8MEG-0003	WASHJET NOZZLE,HSS	10.96	11370-1/4X1/4	JET STABILIZER,BRASS	10.08
1/8MEG-0004	WASHJET NOZZLE,HSS	10.96	11370-1/8X1/8	JET STABILIZER,BRASS	8.38
1/8MEG-0005	WASHJET NOZZLE,HSS	10.96	11370-SS-1/4X1/4	JET STABILIZER, SS	37.47
1/8MEG-0006	WASHJET NOZZLE,HSS	10.96	11370-SS-1/8X1/8	JET STABILIZER, SS	23.53
1/8MEG-0007	WASHJET NOZZLE,HSS	10.96	114396-1-NYR	QT CAP NY LT BLACK W/GASKET & O-RING	2.13
1/8MEG-0008	WASHJET NOZZLE,HSS	10.96	114396-7-NYR	QT CAP NY LT BROWN W/GASKET & O-RING	2.13
1/8MEG-0009	WASHJET NOZZLE,HSS	10.96	114429-2-NYB	1/2" UPPER CLAMP 6MM HEX	2.75
1/8MEG-0010	WASHJET NOZZLE,HSS	10.96	114429-3-NYB	3/4" UPPER CLAMP 6MM HEX	2.75
1/8MEG-0011	WASHJET NOZZLE,HSS	10.96	114429-4-NYB	1" UPPER CLAMP 6MM HEX	2.75
1/8MEG-0015	WASHJET NOZZLE,HSS	10.96	114429-5-NYB	25MM UPPER CLAMP 6MM HEX	2.75
1/8MEG-0020	WASHJET NOZZLE,HSS	10.96	114429-NYB	20MM UPPER CLAMP 6MM HEX	2.75
1/8MEG-0502	WASHJET NOZZLE,HSS	10.96	114441A-1-CELR	25612 REP. Q.T.CAP CE BLACK &GASKET	1.59
1/8MEG-0503	WASHJET NOZZLE,HSS	10.96	114441A-1-CELVI	25612 REP. Q.T. CAP CE BLACK & VITON GASKET	3.97
1/8MEG-0504	WASHJET NOZZLE,HSS	10.96	114441A-10-CELR	25612 REP. Q.T. CAP CE VIOLET & GASKET	1.59
1/8MEG-0505	WASHJET NOZZLE,HSS	10.96	114441A-10-CELVI	25612 REP. Q.T. CAP CE VIOLET & VITON GASKET	3.97
1/8MEG-0506	WASHJET NOZZLE,HSS	10.96	114441A-11-CELR	25612 REP. Q.T. CAP CE LIGHT BLUE & GASKET	1.59
1/8MEG-0507	WASHJET NOZZLE,HSS	10.96	114441A-11-CELVI	25612 REP. Q.T. CAP CE LIGHT BLUE & VITON GASKET	3.97
1/8MEG-0508	WASHJET NOZZLE,HSS	10.96	114441A-2-CELR	25612 REP. Q.T. CAP CE WHITE & GASKET	1.59
1/8MEG-0509	WASHJET NOZZLE,HSS	10.96	114441A-2-CELVI	25612 REP. Q.T. CAP CE WHITE & VITON GASKET	3.97
1/8MEG-1502	WASHJET NOZZLE,HSS	10.96	114441A-3-CELR	25612 REP. Q.T. CAP CE RED &GASKET	1.59
1/8MEG-1503	WASHJET NOZZLE,HSS	10.96	114441A-3-CELVI	25612 REP. Q.T. CAP CE RED & VITON GASKET	3.97
1/8MEG-1504	WASHJET NOZZLE,HSS	10.96	114441A-4-CELR	25612 REP. Q.T. CAP CE BLUE & GASKET	1.59
1/8MEG-1505	WASHJET NOZZLE,HSS	10.96	114441A-4-CELVI	25612 REP. Q.T. CAP CE BLUE & VITON GASKET	3.97
1/8MEG-1506	WASHJET NOZZLE,HSS	10.96	114441A-5-CELR	25612 REP. Q.T. CAP CE GREEN & GASKET	1.59
1/8MEG-1507	WASHJET NOZZLE,HSS	10.96	114441A-5-CELVI	25612 REP. Q.T. CAP CE GREEN & VITON GASKET	3.97
1/8MEG-1508	WASHJET NOZZLE,HSS	10.96	114441A-6-CELR	25612 REP. Q.T. CAP CE YELLOW & GASKET	1.59
1/8MEG-1509	WASHJET NOZZLE,HSS	10.96	114441A-6-CELVI	25612 REP. Q.T. CAP CE YELLOW & VITON GASKET	3.97
1/8MEG-1510	WASHJET NOZZLE,HSS	10.96	114441A-7-CELR	25612 REP. Q.T. CAP CE BROWN & GASKET	1.59
1/8MEG-1515	WASHJET NOZZLE,HSS	10.96	114441A-7-CELVI	25612 REP. Q.T. CAP CE BROWN & VITON GASKET	3.97
1/8MEG-2501	WASHJET NOZZLE,HSS	10.96	114441A-8-CELR	25612 REP. Q.T.CAP CE ORANGE & GASKET	1.59
1/8MEG-2502	WASHJET NOZZLE,HSS	10.96	114441A-8-CELVI	25612 REP. Q.T. CAP CE ORANGE & VITON GASKET	3.97
1/8MEG-2503	WASHJET NOZZLE,HSS	10.96	114441A-9-CELR	25612 REP. Q.T. CAP CE GREY & GASKET	1.59
1/8MEG-2504	WASHJET NOZZLE,HSS	10.96	114441A-9-CELVI	25612 REP. Q.T. CAP CE GRAY & VITON GASKET	3.97
1/8MEG-2505	WASHJET NOZZLE,HSS	10.96	114443A-1-CELR	25598 REP. Q.T. CAP CE BLACK & GASKET	1.79
1/8MEG-2506	WASHJET NOZZLE,HSS	10.96	114443A-1-CELVI	25598 REP. Q.T. CAP CE BLACK & VITON GASKET	4.20
1/8MEG-2507	WASHJET NOZZLE,HSS	10.96	114443A-10-CELR	25598 REP. Q.T. CAP CE VIOLET & GASKET	1.79
1/8MEG-25075	WASHJET NOZZLE,HSS	10.96			
1/8MEG-2508	WASHJET NOZZLE,HSS	10.96			
1/8MEG-2509	WASHJET NOZZLE,HSS	10.96			
1/8MEG-2510	WASHJET NOZZLE,HSS	10.96			
1/8MEG-2515	WASHJET NOZZLE,HSS	10.96			
1/8MEG-4002	WASHJET NOZZLE,HSS	10.96			
1/8MEG-4003	WASHJET NOZZLE,HSS	10.96			
1/8MEG-4004	WASHJET NOZZLE,HSS	10.96			
1/8MEG-4005	WASHJET NOZZLE,HSS	10.96			
1/8MEG-4006	WASHJET NOZZLE,HSS	10.96			
1/8MEG-4007	WASHJET NOZZLE,HSS	10.96			
1/8MEG-4008	WASHJET NOZZLE,HSS	10.96			
1/8MEG-4009	WASHJET NOZZLE,HSS	10.96			
1/8MEG-4010	WASHJET NOZZLE,HSS	10.96			
1/8MEG-5005	WASHJET NOZZLE,HSS	10.96			
1/8MEG-6504	WASHJET NOZZLE,HSS	10.96			
1/8MEG-6506	WASHJET NOZZLE,HSS	10.96			
1/8MEG-6508	WASHJET NOZZLE,HSS	10.96			
10123-1/4-281	TEEJET HOSE SHANK,BR	7.06			
10516	CORE BODY ASB,BR,12	26.00			
10516-AL	CORE BODY ASB,AL,12	25.05			
10565-1-NY	CORE ASB BRASS & NY	42.50			
10565-1-NY-AL	CORE ASB ALUM & NY	42.50			
10565-AL/NY	AL CORE ASBY NY SEAT	42.50			

PART NO.	DESCRIPTION	U.S.DOLLARS	PART NO.	DESCRIPTION	U.S.DOLLARS
114443A-10-CELR	25598 REP. Q.T. CAP CE VIOLET & VITON GASKET	4.20	114445A-6-CELR	25608 REP. Q.T. CAP CE YELLOW & VITON GASKET	4.20
114443A-11-CELR	25598 REP. Q.T. CAP CE LIGHT BLUE & GASKET	1.79	114445A-7-CELR	25608 REP. Q.T. CAP CE BROWN & GASKET	1.79
114443A-11-CELVI	25598 REP. Q.T. CAP CE LIGHT BLUE & VITON GASKET	4.20	114445A-7-CELVI	25608 REP. Q.T. CAP CE BROWN & VITON GASKET	4.20
114443A-2-CELR	25598 REP. Q.T. CAP CE WHITE & GASKET	1.79	114445A-8-CELR	25608 REP. Q.T. CAP CE ORANGE & GASKET	1.79
114443A-2-CELVI	25598 REP. Q.T. CAP CE WHITE & VITON GASKET	4.20	114445A-8-CELVI	25608 REP. Q.T. CAP CE ORANGE & VITON GASKET	4.20
114443A-3-CELR	25598 REP. Q.T. CAP CE RED & GASKET	1.79	114445A-9-CELR	25608 REP. Q.T. CAP CE GREY & GASKET	1.79
114443A-3-CELVI	25598 REP. Q.T. CAP CE RED & VITON GASKET	4.20	114445A-9-CELVI	25608 REP. Q.T. CAP CE GRAY & VITON GASKET	4.20
114443A-4-CELR	25598 REP. Q.T. CAP CE BLUE & GASKET	1.79	114447A-1-CELR	19843 REP. Q.T. CAP CE BLACK & GASKET	3.38
114443A-4-CELVI	25598 REP. Q.T. CAP CE BLUE & VITON GASKET	4.20	114447A-1-CELVI	19843 REP. Q.T. CAP CE BLACK & VITON GASKET	5.79
114443A-5-CELR	25598 REP. Q.T. CAP CE GREEN & GASKET	1.79	114455-1	QJS-N ELBOW SUB-ASSY	32.03
114443A-5-CELVI	25598 REP. Q.T. CAP CE BLUE & VITON GASKET	4.20	114455-1-6	QJS-N 1" ELBOW SUB-ASSY 6MM	32.03
114443A-6-CELR	25598 REP. Q.T. CAP CE YELLOW & GASKET	1.79	114455-1/2-6	QJS-N 1/2" ELBOW SUB-ASSY 6MM	32.03
114443A-6-CELVI	25598 REP. Q.T. CAP CE YELLOW & VITON GASKET	4.20	114455-1/2-NYB	QJS-N ELBOW SUB-ASSY	32.03
114443A-7-CELR	25598 REP. Q.T. CAP CE BROWN & GASKET	1.79	114455-20MM-6	QJS-N 20MM ELBOW SUB-ASSY 6MM	32.03
114443A-7-CELVI	25598 REP. Q.T. CAP CE BROWN & VITON GASKET	4.20	114455-20MM-NYB	QJS-N 20MM ELBOW SUB-ASSY	32.03
114443A-8-CELR	25598 REP. Q.T. CAP CE ORANGE & GASKET	1.79	114455-25MM	QJS-N 25MM ELBOW SUB-ASSY	32.03
114443A-8-CELVI	25598 REP. Q.T. CAP CE ORANGE & VITON GASKET	4.20	114455-25MM-6	QJS-N 25MM ELBOW SUB-ASSY 6MM	32.03
114443A-9-CELR	25598 REP. Q.T. CAP CE GRAY & GASKET	1.79	114455-3/4-6	QJS-N 3/4" ELBOW SUB-ASSY 6MM	32.03
114443A-9-CELVI	25598 REP. Q.T. CAP CE GRAY & VITON GASKET	4.20	114455-3/4-NYB	QJS-N ELBOW SUB-ASSY	32.03
114445A-1-CELR	25608 REP. Q.T. CAP CE BLACK & GASKET	1.79	114465-25MM-NYB	SPLIT EYELET SUB-ASSEMBLY	66.84
114445A-1-CELVI	25608 REP. Q.T. CAP CE BLACK & VITON GASKET	4.20	114466-1-NYB	Split Eyelet Sub-Assembly	135.48
114445A-10-CELR	25608 REP. Q.T. CAP CE VIOLET & GASKET	1.79	114466-1/2-NYB	SPLIT EYELET SUB-ASSEMBLY	135.48
114445A-10-CELVI	25608 REP. Q.T. CAP CE VIOLET & VITON GASKET	4.20	114466-20MM-NYB	SPLIT EYELET SUB-ASSEMBLY	135.48
114445A-11-CELR	25608 REP. Q.T. CAP CE LIGHT BLUE & GASKET	1.79	114466-25MM-NYB	SPLIT EYELET SUB-ASSEMBLY	135.48
114445A-11-CELVI	25608 REP. Q.T. CAP CE LIGHT BLUE & VITON GASKET	4.20	114466-3/4-NYB	SPLIT EYELET SUB-ASSEMBLY	135.48
114445A-2-CELR	25608 REP. Q.T. CAP CE WHITE & GASKET	1.79	114469-1-6-NYB	QJS-I 1" SIDE MOUNT 6MM	61.88
114445A-2-CELVI	25608 REP. Q.T. CAP CE WHITE & VITON GASKET	4.20	114469-1-NYB	QJS-I 1" SIDE MOUNT	61.88
114445A-3-CELR	25608 REP. Q.T. CAP CE RED & GASKET	1.79	114469-1/2-6-NYB	QJS-I 1/2" SIDE MOUNT 6MM	61.88
114445A-3-CELVI	25608 REP. Q.T. CAP CE RED & VITON GASKET	4.20	114469-1/2-NYB	QJS-I 1/2" SIDE MOUNT	61.88
114445A-4-CELR	25608 REP. Q.T. CAP CE BLUE & GASKET	1.79	114469-20MM-6-NYB	QJS-I 20MM SIDE MOUNT 6MM	61.88
114445A-4-CELVI	25608 REP. Q.T. CAP CE BLUE & VITON GASKET	4.20	114469-20MM-NYB	QJS-I 20MM SIDE MOUNT	61.88
114445A-5-CELR	25608 REP. Q.T. CAP CE GREEN & GASKET	1.79	114469-25MM-6-NYB	QJS-I 25MM SIDE MOUNT 6MM	61.88
114445A-5-CELVI	25608 REP. Q.T. CAP CE GREEN & VITON GASKET	4.20	114469-25MM-NYB	QJS-I 25MM SIDE MOUNT	61.88
114445A-6-CELR	25608 REP. Q.T. CAP CE YELLOW & GASKET	1.79	114469-28MM-NYB	QJS-I 28MM SIDE MOUNT	61.88
			114469-3/4-6-NYB	QJS-I 3/4" SIDE MOUNT 6MM	61.88
			114469-3/4-NYB	QJS-I 3/4" SIDE MOUNT	61.88
			114502A-1-CELR	Q.T. CAP CE BLACK	2.95
			114502A-1-CELVI	Q.T. CAP CE BLACK VITON GASKET	5.36
			114502A-11-CELR	Q.T. CAP CE LIGHT BLUE	2.95
			114502A-11-CELVI	Q.T. CAP CE LIGHT BLUE VITON GASKET	5.36
			114502A-12-CELR	Q.T. CAP CE RASBERRY RED	2.95
			114502A-12-CELVI	Q.T. CAP CE RASBERRY RED VITON GASKET	5.36
			114502A-13-CELR	Q.T. CAP CE LIGHT GREEN	2.95
			114502A-13-CELVI	Q.T. CAP CE LIGHT GREEN VITON GASKET	5.36
			114502A-2-CELR	Q.T. CAP CE WHITE	2.95
			114502A-2-CELVI	Q.T. CAP CE WHITE VITON GASKET	5.36
			115594-22CP05	EC SHUT-OFF MOTOR ASB	390.57
			115594-25CP03	BEC RPL MOTOR	390.57
			115594-25CP05	BEC RPL MOTOR	390.57

PART NO.	DESCRIPTION	U.S.DOLLARS	PART NO.	DESCRIPTION	U.S.DOLLARS
115594-25CP05PC	BEC RPL MOTOR	412.53	115880-4-24	115880-4-24 DYNAJET VALVE	267.40
115594-25CP05QC	BEC RPL MOTOR	412.53	115880-4-24-05	115880-4-24 DYNAJET VALVE	282.12
115594-25CP05RC	BEC RPL MOTOR	412.53	115880-6-12	115880-6-12 DYNAJET VALVE	267.40
115594-25CP15	BEC RPL MOTOR	404.93		WILGER	
115594-25CP15TU	BEC RPL MOTOR	427.61	115880-6-24	115880-6-24 DYNAJET VALVE	267.40
115594-25CP60	BEC RPL MOTOR	443.60		WILGER	
115594-25P	BEC RPL MOTOR	369.17	115880-7-12	115880-7-12 DYNAJET VALVE	267.40
115595-1-NYB	1" WET BOOM CLAMP	8.23		ARAG	
115835A-1-CELR	TTI CAP CE BLACK & GASKET	1.79	116240-LM	LQC MALE TEE	25.02
115835A-1-CELVI	TTI CAP CE BLACK & VITON WASHER	4.20	116244	50F TEE W/ PTC	125.41
			116245-NYB	CLIP RETENTION CAP SUB-ASSEMBLY	14.79
115835A-10-CELR	TTI CAP CE VIOLET & GASKET	1.79			
115835A-10-CELVI	TTI CAP CE VIOLET & VITON GASKET	4.20	116280-12	116280 DYNAJET HF VALVE 12V ASSEMBLY	308.00
			116280-24	116280 DYNAJET HF VALVE 24V ASSEMBLY	308.00
115835A-3-CELR	TTI CAP CE RED & GASKET	1.79	116280-7-12	116280 DYNAJET HF VALVE 12V ASSEMBLY F/ ARAG	308.00
115835A-3-CELVI	TTI CAP CE RED & VITON GASKET	4.20	116280-7-24	116280 DYNAJET HF VALVE 24V ASSEMBLY F/ ARAG	308.00
115835A-4-CELR	TTI CAP CE BLUE & GASKET	1.79	116882-NYB	#373 TURRET BODY SUB-ASSEMBLY	22.38
115835A-4-CELVI	TTI CAP CE BLUE & VITON GASKET	4.20	116883-NYB	#375 TURRET BODY SUB-ASSEMBLY	23.36
115835A-5-CELR	TTI CAP CE GREEN & GASKET	1.79	116892-2	QJS SIDE END BODY, RIGHT SUB-ASSEMBLY	21.37
115835A-5-CELVI	TTI CAP CE GREEN & VITON GASKET	4.20	116893-2	QJS SIDE END BODY, LEFT SUB-ASSEMBLY	21.37
115835A-6-CELR	TTI CAP CE YELLOW & GASKET	1.79	116925-3-1	RPL/ASB L/MTR 4 BOLT 1"	322.75
115835A-6-CELVI	TTI CAP CE YELLOW & VITON GASKET	4.20	116925-3-1-SS	PL/ASB L/MTR 4 BOLT 1" SS BALL	445.31
115835A-7-CELR	TTI CAP CE BROWN & GASKET	1.79	116925-3-3/4	RPL/ASB L/MTR 4 BOLT 3/4"	322.75
115835A-7-CELVI	TTI CAP CE BROWN & VITON GASKET	4.20	116925-3-3/4-SS	RPL/ASB L/MTR 4 BOLT 3/4" SS BALL	445.31
115835A-9-CELR	TTI CAP CE GREY & GASKET	1.79	116925-3-F	RPL/ASB L/MTR 4 BOLT 50F	322.75
115835A-9-CELVI	TTI CAP CE GREY & VITON GASKET	4.20	116925-3-F-SS	RPL/ASB L/MTR 4 BOLT 50F SS BALL	445.31
115870-16-532AM-2	530AM 2-WAY SPECIAL ASSEMBLY	296.87	116925-3-Q	RPL/ASB L/MTR 4 BOLT QC	322.75
115870-16-533AM-2	530AM 2-WAY SPECIAL ASSEMBLY	357.30	116925-3-Q-SS	RPL/ASB L/MTR 4 BOLT QC SS BALL	445.31
115870-16-534AM-2	530AM 2-WAY SPECIAL ASSEMBLY	417.71	116950-12	116950 E-CHEMSAVER ES 12V ASSEMBLY	179.20
115870-16-535AM-2	530AM 2-WAY SPECIAL ASSEMBLY	478.18	116950-12-05	116950 E-CHEMSAVER ES W/0.5M CABLE	212.88
115870-18-534AM-2	530AM 2-WAY SPECIAL ASSEMBLY	213.50	116950-12-15	116950 E-CHEMSAVER ES W/1.5M CABLE	225.55
115870-5-533AM-2	530AM MANUAL 2-WAY PLUNGER VALVE ASSEMBLY	171.47	116950-12-30	116950 E-CHEMSAVER ES W/3.0 CABLE	233.85
115870-5-534AM-2	530AM MANUAL 2-WAY PLUNGER VALVE ASSEMBLY	213.50	116950-12-60	116950 E-CHEMSAVER ES W/6.0 CABLE	239.24
115870-8-532AM-2	530AM 2-WAY SPECIAL ASSEMBLY	195.90	116950-24	116950 E-CHEMSAVER ES 24V ASSEMBLY	179.20
115871	530AM MANUAL 2-WAY PLUNGER VALVE ASSEMBLY	61.24	116950-7-12	116950 E-CHEMSAVER ES 12V ASSEMBLY F/ARAG	179.20
115871-NYB	530AM MANUAL 2-WAY PLUNGER VALVE ASSEMBLY	64.29	116950-7-24	116950 E-CHEMSAVER ES 24V ASSEMBLY F/ARAG	179.20
115880-1-12	115880-1-12 DYNAJET VALVE	267.40	11717-1/4X1/4	SWIVEL CONNECT,BRASS	22.22
115880-1-12-05	115880-1-12 DYNAJET VALVE	282.12	11740B	GARDEN HOSE SWIVEL	53.99
115880-1-12-15	115880-1-12 DYNAJET VALVE	288.43	11740B-GHX3/4	GARDEN HOSE SWIVEL	53.99
115880-1-12-200	115880-1-12 DYNAJET VALVE	425.00	11750-10	TEEJET CHECK VALV,BR	9.90
115880-1-12-30	115880-1-12 DYNAJET VALVE	296.93	11750-20	TEEJET CHECK VALV,BR	9.90
115880-1-12-60	115880-1-12 DYNAJET VALVE	314.69	11750-5	TEEJET CHECK VALV,BR	9.90
115880-1-24	115880-1-24 DYNAJET VALVE	267.40	11750-AL-10	TEEJET CHECK VALV,AL	10.66
115880-1-24-05	115880-1-24 DYNAJET VALVE	282.12	11750-AL-5	TEEJET CHECK VALV,AL	10.66
115880-1-24-60-FC	115880-1-24 DYNAJET VALVE	339.52	11750-PP-10	TEEJET CHECK CTRL,PP	8.42
115880-2-12	115880-2-12 DYNAJET VALVE	267.40	11750-PP-5	#5 LB. SPRING TEEJET CHECK VALV,PP	8.42
115880-2-12-05	115880-1-12 DYNAJET VALVE	282.12	11750-SS-10	TEEJET CHECK VALV,SS	31.55
115880-2-12-30	115880-2-12 DYNAJET VALVE	296.93			
115880-2-24	115880-2-24 DYNAJET VALVE	267.40			
115880-2-24-05	115880-2-24 DYNAJET VALVE	282.12			
115880-4-12	115880-4-12 DYNAJET VALVE	267.40			
115880-4-12-05	115880-1-12 DYNAJET VALVE	282.12			

PART NO.	DESCRIPTION	U.S.DOLLARS	PART NO.	DESCRIPTION	U.S.DOLLARS
11750-SS-20	TEEJET CHECK VALV,SS	31.55	12430-AY-HSS120	ADJ.CONEJET,HSS ORIF	85.78
11750-SS-5	TEEJET CHECK VALV,SS	31.55	12430-AY-HSS16	ADJ.CONEJET,HSS ORIF	85.78
118530-5-533AEC-2-D	530 2-WAY SPECIAL ASSEMBLY	890.81	12430-AY-HSS180	ADJ.CONEJET,HSS ORIF	85.78
118530-6-532AEC-2-P	530 2-WAY SPECIAL ASSEMBLY	803.63	12430-AY-HSS20	ADJ.CONEJET,HSS ORIF	85.78
118530-6-533AEC-2-P	530 2-WAY SPECIAL ASSEMBLY	1130.31	12430-AY-HSS240	ADJ.CONEJET,HSS ORIF	85.78
118530-6-534AEC-2-P	530 2-WAY SPECIAL ASSEMBLY	1454.51	12430-AY-HSS30	ADJ.CONEJET,HSS ORIF	85.78
118530-6-535AEC-2-P	530 2-WAY SPECIAL ASSEMBLY	1777.99	12430-AY-HSS45	ADJ.CONEJET,HSS ORIF	85.78
118531-EC-D	530AEC-2 VALVE RPL, DIN	277.05	12430-AY-HSS60	ADJ.CONEJET,HSS ORIF	85.78
118531-EC-P	530AEC-2 VALVE RPL, MP	255.63	12430-AY-HSS90	ADJ.CONEJET,HSS ORIF	85.78
118560	PRESSURE RELIEF VALVE ASSEMBLY	89.24	12431-BRHSS	CORE&INS,BRHSS,12430	38.69
118570	THROTTLING VALVE ASSEMBLY	84.66	12431-TC	CORE&INSRT,TC,12430	85.68
11880-1-110-3/8-50	PRV WITH THD BONNET FOR SPRAY TANK	101.91	12521A-1/2X1/4	SPLIT-EYELET CONN.BR	15.55
1194	STRAINER BODY,BRASS	8.69	12521A-1/2X1/8	SPLIT-EYELET CONN.BR	15.55
11950	TEEJET JET STABIL,BR	9.47	12521A-1X1/4	SPLIT-EYELET CONN.BR	15.55
11950-AL	TEEJET JET STABIL,AL	9.47	12521A-1X1/8	SPLIT-EYELET CONN.BR	15.55
11950-SS	TEEJET JET STABIL,SS	24.52	12521A-3/4X1/4	SPLIT-EYELET CONN.BR	15.55
11990-10	SWIVEL,BRASS	25.68	12521A-3/4X1/8	SPLIT-EYELET CONN.BR	15.55
11990-12	SWIVEL,BRASS	25.68	12521B-1/2X1/4	SPLT-EYLT.CON.ALL SS	36.75
11990-13	SWIVEL,BRASS	25.68	12521B-1/2X1/8	SPLT-EYLT.CON.ALL SS	36.75
11990-14	SWIVEL,BRASS	34.11	12521B-1X1/4	SPLT-EYLT.CON.ALL SS	36.75
11990-15	SWIVEL,BRASS	34.11	12521B-1X1/8	SPLT-EYLT.CON.ALL SS	36.75
11990-16	SWIVEL,BRASS	34.11	12521B-3/4X1/4	SPLT-EYLT.CON.ALL SS	36.75
11990-16-BRSS	SWIVEL BRASS & SS	54.02	12521B-3/4X1/8	SPLT-EYLT.CON.ALL SS	36.75
11990-17	SWIVEL,BRASS	54.58	12521C-1/2X1/4	SPLIT-EYELET CONN.SS	23.05
11990-18	SWIVEL,BRASS	54.58	12521C-1/2X1/8	SPLIT-EYELET CONN.SS	23.05
11990-19	SWIVEL,BRASS	54.58	12521C-1X1/4	SPLIT-EYELET CONN.SS	23.05
11990-20	SWIVEL BRASS	32.37	12521C-1X1/8	SPLIT-EYELET CONN.SS	23.05
11990-21	SWIVEL BRASS	32.37	12521C-3/4X1/4	SPLIT-EYELET CONN.SS	23.05
11990-6	SWIVEL,BRASS	25.68	12521C-3/4X1/8	SPLIT-EYELET CONN.SS	23.05
11990-60	SWIVEL,BRASS	25.68	12670-406TD-NYB	TEEJET HOSE BODY,ASB	9.82
11990-61	SWIVEL,BRASS	25.68	12670-406TD-SS	TEEJET HOSE BODY, ASB	76.98
11990-62	SWIVEL,BRASS	25.68	12686-100	STR.ASB,BRASS,1/8VVL	3.54
11990-63	SWIVEL,BRASS	25.68	12686-200	STR.ASB,BRASS,1/8VVL	3.54
11990-64	SWIVEL,BRASS	25.68	12686-50	STR.ASB,BRASS,1/8VVL	3.54
11990-65	SWIVEL,BRASS	25.68	12686-SS-100	STR.ASB,SS,1/8VVL-	12.02
11990-7	SWIVEL,BRASS	25.68	12686-SS-200	STR.ASB,SS,1/8VVL-	12.02
11990-8	SWIVEL,BRASS	25.68	12686-SS-50	STR.ASB,SS,1/8VVL-	12.02
11990-9	SWIVEL,BRASS	25.68	12687-100	STR.ASB,BRASS,1/4VVL	3.54
12073-1/4T	TEEJET SW.BDY.ASB,BR	31.04	12687-200	STR.ASB,BRASS,1/4VVL	3.54
12073-1/8T	TEEJET SW.BDY.ASB,BR	31.04	12687-24	STR.ASB,BRASS,1/4VVL	3.54
12074-1/4TT	TEEJET SW.BDY.ASB,BR	31.04	12687-50	STR.ASB,BRASS,1/4VVL	3.54
12077-1/4T	TEEJET SW.BDY.ASB,BR	44.80	12687-SS-100	STR.ASB,SS,1/4VVL-	12.10
12201-CE-1062TD	TEEJET HOSE CONN.ASB	20.27	12687-SS-20	STR.ASB,SS,1/4VVL-	12.10
12201-CE-785TD	TEEJET HOSE CONN.ASB	20.27	12687-SS-200	STR.ASB,SS,1/4VVL-	12.10
12202-CE-1062TD	TEEJET HOSE CONN.ASB	20.27	12687-SS-50	STR.ASB,SS,1/4VVL-	12.10
12202-CE-785TD	TEEJET HOSE CONN.ASB	20.27	12690-1/2-NYB	THROTTLING VALVE,NYL	139.93
12328-1/2	DIA.CHECK VLVE.BRASS	329.49	12690-3/4-NYB	THROTTLING VALVE,NYL	139.93
12328-1/2-AL	DIA.CHECK VLVE.ALUM.	220.91	12795-1	THROTTLING VALVE,BR.	289.29
12328-1/2-NYB	DIA.CHECK VLVE,NYLON	130.44	12795-1-1/2	THROTTLING VALVE,BR.	393.54
12328-3/4	DIA.CHECK VLVE.BRASS	329.49	12795-1-1/2-AL	THROTTLING VALVE,AL	278.96
12328-3/4-AL	DIA.CHECK VLVE.ALUM	220.91	12795-1-1/2-DI	THROTTLING VALVE,DI	289.02
12328-3/4-NYB	DIA.CHECK VLVE,NYLON	130.44	12795-1-1/4	THROTTLING VALVE,BR.	300.01
12328-NYB-SS-1/2	DIA. CHECK VALVE,NYLON & SS	173.49	12795-1-1/4-AL	THROTTLING VALVE,AL	220.33
12328-NYB-SS-3/4	DIA. CHECK VALVE,NYLON & SS	173.49	12795-1-1/4-DI	THROTTLING VALVE,DI	232.66
12329-CE	BONNET SUB-ASB.NY.	60.14	12795-1-AL	THROTTLING VALVE,AL	208.08
12338-1/2-NYB	BODY ASB,NYLON,12328	46.08	12795-1-DI	THROTTLING VALVE,DI	225.71
12338-3/4-NYB	BODY ASB,NYLON,12328	46.08	12931-NYB	DIAPH.TEEJET NOZ,NY	26.36
12381-15-PP	JET AGITOR.BR.W/PP	89.03	13212-1/2	GARDEN HOSE ADAP.BR.	8.08
12381-20-PP	JET AGITOR.BR.W/PP	89.03	13212-3/8	GARDEN HOSE ADAP.BR.	8.08
12381-25-PP	JET AGITOR.BR.W/PP	89.03	13417	TUBE&TIP BRASS,6960	24.52
12381-40-PP	JET AGITOR.BR.W/PP	89.03	13418	TUBE&AIR TIP BR.6960	23.66
12381-50-PP	JET AGITOR.BR.W/PP	89.03	13430-1L-406-NYB	H.SHANK DIAPH.NOZ,NY	31.89
			13430-1L-540-NYB	H.SHANK DIAPH.NOZ,NY	31.89
			13430-1R-406-NYB	H.SHANK DIAPH.NOZ,NY	31.89

PART NO.	DESCRIPTION	U.S.DOLLARS	PART NO.	DESCRIPTION	U.S.DOLLARS
13430-1R-540-NYB	H.SHANK DIAPH.NOZ,NY	31.89	19350-212-785-NYB	BODY SUB ASM,QJ212	14.91
13430-2-406-NYB	H.SHANK DIAPH.NOZ,NY	31.89	19350-212-785-NYB-VI	BODY SUB ASM, QJ212, VITON	16.40
13430-2-540-NYB	H.SHANK DIAPH.NOZ,NY	31.89	19351-213-406-NYB	BODY SUB ASM,QJ213	14.91
13430-3-406-NYB	H.SHANK DIAPH.NOZ,NY	31.89	19351-213-406-NYB-VI	BODY SUB ASM, QJ213, VITON	16.40
13430-3-540-NYB	H.SHANK DIAPH.NOZ,NY	31.89	19351-213-540-NYB	BODY SUB ASM,QJ213	14.91
13431-NYB	DIAPH.TEEJET ASB,NY.	25.53	19351-213-540-NYB-VI	BODY SUB ASM, QJ213, VITON	16.40
13434-406-NYB	SINGLE HOSE SHANK CONN,NY.	6.60	19351-213-785-NYB	BODY SUB ASM,QJ213	14.91
13435-406-NYB	DOUBLE HOSE SHANK CONN,NY.	6.60	19351-213-785-NYB-VI	BODY SUB ASM, QJ213, VITON	16.40
13436-406-NYB	TRIPLE HOSE SHANK CONN,NY.	6.60	19845-25-PP	TIP STRAINER RED, POLYPRO	2.25
13437-540-NYB	SINGLE HOSE SHANK CONN,NY.	6.60	19845-50-PP	TIP STRAINER BLUE ,POLYPRO	2.25
13438-540-NYB	DOUBLE HOSE SHANK CONN,NY.	6.60	1K-300	FLOODJET NOZ.,BRASS	157.19
13439-540-NYB	TRIPLE HOSE SHANK CONN,NY.	6.60	1K-450	FLOODJET NOZ.,BRASS	183.92
14269	GARDEN HOSE ADAP.ASB	20.63	1K-SS300	FLOODJET NOZ.,ST.STL	232.47
15427-1-296	TEEJET HOSE SHANK	13.51	1K-SS450	FLOODJET NOZ.,ST.STL	272.08
15457-2-031	MULTIPLE ORIFICE TIP	15.94	1QPW-100	STRAINER,MONEL	29.35
15457-3-031	MULTIPLE ORIFICE TIP	19.56	1QPW-24	STRAINER,ST STL	29.35
15905	144A-1 COIL SUB/ASBL	91.76	1QPW-50	STRAINER,ST STL	29.35
15950	HIGH PRES.SWIVEL BR.	101.20	1TW-100	STRAINER,CAST IRON	247.06
15950-SS	HIGH PRES.SWIVEL SS	156.90	1TW-16	STRAINER,CAST IRON	247.06
16131-125	PRE-ORIFICE BR.3/4KQ	3.86	1TW-200	STRAINER,CAST IRON	247.06
16131-140	PRE-ORIFICE BR.3/4KQ	3.86	1TW-30	STRAINER,CAST IRON	247.06
16131-156	PRE-ORIFICE BR.3/4KQ	3.86	1TW-50	STRAINER,CAST IRON	247.06
16131-172	PRE-ORIFICE BR.3/4KQ	3.86	1TW-80	STRAINER,CAST IRON	247.06
16131-185	PRE-ORIFICE BR.3/4KQ	3.86	1TW-B50	STRAINER,BRASS	625.29
16131-199	PRE-ORIFICE BR.3/4KQ	3.86	20291	DIAPH.CK.VLV.BRASS	52.63
16131-46	PRE-ORIFICE BR.3/4KQ	3.86	20291-1-VI	#8 LB. SPRING DIAPH CK VLV BRASS W/VITON DIAPH	54.19
16131-62	PRE-ORIFICE BR.3/4KQ	3.86	20301-1N	3X1 (26X76MM) WTR SENS PAPER	64.53
16131-78	PRE-ORIFICE BR.3/4KQ	3.86	20301-2N	3X2 (52X76MM) WTR SENS PAPER	107.15
16917-144A-1-VI	DIRECTOVALVE	274.38	20301-3N	20X1(26X500MM) WTR SENS PAPER	199.81
16946-AY-TCHSS20	CAP/INSERT-SUB-ASB	89.73	20570-1-1/2-PPB	CLIP EYELET L/TIP,BLACK	10.16
16946-AY-TCHSS30	CAP/INSERT-SUB-ASB	89.73	20570-1-1/4-PP	CLIP EYELET L/TIP,GREY	10.16
16946-AY-TCHSS45	CAP/INSERT-SUB-ASB	89.73	20570-1-PP	CLIP EYELET L/TIP,GREY	10.16
16946-AY-TCHSS60	CAP/INSERT-SUB-ASB	89.73	20570-2-PPB	CLIP EYELET L/TIP,BLACK	15.81
18081-124-1-1/2-AL	LINE STRAINER ALUM.	314.23	20570D-1-1/2-PPB	CLIP EYELET L/TIP	11.36
18623-1	SUB/ASSBLY FOR 145H	79.15	20570D-1-1/4-PP	CLIP EYELET L/TIP	11.36
18635-111-406-NYB	SINGLE HOSE SHANK,NY	6.05	20570D-1-PP	CLIP EYELET L/TIP	11.36
18636-112-406-NYB	DOUBLE HOSE SHANK,NY	6.05	20570D-2-PPB	CLIP EYELET L/TIP	17.57
18637-113-406-NYB	TRIPLE HOSE SHANK,NY	6.05	20897	GARDEN HOSE ADAPTER	11.00
18638-111-540-NYB	SINGLE HOSE SHANK,NY	6.05	20900-1/4FXT	BALL VALVE BRASS	86.80
18639-112-540-NYB	DOUBLE HOSE SHANK,NY	6.05	20900-1/4MXT	BALL VALVE BRASS	86.80
18640-113-540-NYB	TRIPLE HOSE SHANK,NY	6.05	21353-6-15-NYB	HOSE DROP NYLON	17.84
18642-NYB-406	SINGLE HS CONN,1/4F	5.70	21353-6-24-NYB	HOSE DROP NYLON	17.84
18643-NYB-406	DOUBLE HS CONN,1/4F	5.70	21354-15-NYB	HOSE DROP NYLON	11.80
18644-NYB-406	TRIPLE HS CONN,1/4F	5.70	21354-24-NYB	HOSE DROP NYLON	13.14
18645-NYB-540	SINGLE HS CONN,1/4F	5.70	21398H-1-CELR	QT CAP & GASKET BLACK	1.85
18646-NYB-540	DOUBLE HS CONN,1/4F	5.70	21398H-10-CELR	QT CAP & GASKET VIOLET	1.85
18647-NYB-540	TRIPLE HS CONN,1/4F	5.70	21398H-2-CELR	QT CAP & GASKET WHITE	1.85
18719-111-785-NYB	SINGLE HOSE SHANK,NY	6.05	21398H-3-CELR	Q.T.CAP&GASKET S-ASB RED	1.85
18720-112-785-NYB	DOUBLE HOSE SHANK,NY	6.05	21398H-4-CELR	Q.T.CAP&GASKET S-ASB BLUE	1.85
18721-113-785-NYB	TRIPLE HOSE SHANK,NY	6.05	21398H-5-CELR	Q.T.CAP&GASKET S-ASB GREEN	1.85
18724-NYB-785	1/4F SINGLE HS CONN	5.70	21398H-6-CELR	Q.T.CAP&GASKET S-ASB YELLOW	1.85
18725-NYB-785	DOUBLE HS CONN,1/4F	5.70	21398H-7-CELR	Q.T. CAP & GASKET BROWN	1.85
18726-NYB-785	TRIPLE HS CONN,1/4F	5.70	21398H-8-CELR	Q.T. CAP & GASKET ORANGE	1.85
19186-1-144	DIRECTOVALVE,POLYPRO	333.25	21950-10-NYB	END CAP SUB-AS.10PSI	5.45
19349-211-406-NYB	BODY SUB ASM,QJ211	14.91	21950-10-PP	END CAP SUB-AS.10PSI POLY	5.45
19349-211-406-NYB-VI	BODY SUB ASM, QJ211, VITON	16.40	21950-15-NY	END CAP 15PSI,RED	5.45
19349-211-540-NYB	BODY SUB ASM,QJ211	14.91	21950-2-NYB	ENDCAP,YELLOW,2 PSI	5.45
19349-211-540-NYB-VI	BODY SUB ASM, QJ211, VITON	16.40	21950-2-PP	END CAP SUB-ASB.2PSI POLY	5.45
19349-211-785-NYB	BODY SUB ASM,QJ211	14.91	21950-20-NYB	END CAP SUB-AS.20PSI	5.45
19349-211-785-NYB-VI	BODY SUB ASM, QJ211, VITON	16.40	21950-30-NYB	END CAP SUB-AS.30PSI	5.45
19350-212-406-NYB	BODY SUB ASM,QJ212	14.91	21950-5-NYB	ENDCAP,5 PSI	5.45
19350-212-406-NYB-VI	BODY SUB ASM, QJ212, VITON	16.40	21950-8-NYB	END CAP SUB-ASB.8PSI	5.45
19350-212-540-NYB	BODY SUB ASM,QJ212	14.91			
19350-212-540-NYB-VI	BODY SUB ASM, QJ212, VITON	16.40			

PART NO.	DESCRIPTION	U.S.DOLLARS	PART NO.	DESCRIPTION	U.S.DOLLARS
21950-8-PP	END CAP SUB-ASB.8PSI POLY	5.45	22650-PP-1/4	TRGRJT 1/4"NPT INLET	41.80
22251-311-375-MC	QJ300 SINGLE W MNL CHMSVR	21.11	22650-PP-300	TRGRJT 1/4"HOSE INLT	41.80
22251-311-375-NYB	QJ300 SINGLE VARI-QUICK SUB-ASB.	12.33	22650-PP-406	TRGRJT 3/8"HOSE INLT	41.80
22251-311-375-NYB-VI	QJ300 SINGLE VARI-QUICK SUB-ASB.	13.84	22665-15-PP	EXTENSION ASB.22670	16.85
22251-311-375-PP	QJ300 SINGLE VARI-QUICK S/ASB.PP	24.89	22665-24-PP	EXTENSION ASB.22670	28.04
22251-311-500-MC	QJ300 SINGLE W MNL CHM SVR	21.11	22669-1/4-PPB	TEEJET ADAPT.POLYPRO	2.66
22251-311-500-NYB	QJ300 SINGLE VARI-QUICK SUB-ASB.	12.33	22670-PP-15-1/4	TRIGGERJET SPRAY GUN	65.88
22251-311-500-NYB-VI	QJ300 SINGLE VARI-QUICK SUB-ASB.	13.84	22670-PP-15-300	15 300 TRIGGERJET POLYPRO W/EXTENSION & SPRAY TIP	65.88
22251-311-500-PP	QJ300 SINGLE VARI-QUICK S/ASB.PP	24.89	22670-PP-15-406	TRIGGERJET SPRAY GUN	65.88
22251-311-750-MC	QJ300 SINGLE W MNL CHMSVR	21.11	22670-PP-24-1/4	24 1/4 TRIGGERJET POLYPRO W/EXTENSION AND 8 TIP	75.94
22251-311-750-NYB	QJ300 SINGLE VARI-QUICK SUB-ASB.	12.33	22670-PP-24-300	TRIGGERJET SPRAY GUN	75.94
22251-311-750-NYB-VI	QJ300 SINGLE VARI-QUICK SUB-ASB.	13.84	22670-PP-24-406	TRIGGERJET SPRAY GUN	75.94
22251-311-750-PP	QJ300 SINGLE VARI-QUICK S/ASB.PP	24.89	22674-1/4-NYB	45 DEG.QT ADAPTER NY	4.14
22252-312-375-MC	QJ300 DOUBLE W MNL CHMSVR	21.11	22995-30-1/4-VI	SPOT GUN APPLICATOR	177.44
22252-312-375-NYB	QJ300 DOUBLE VARI-QUICK SUB-ASB.	12.33	23119-8360-NYB	DIAPH.TEEJET NYLON	24.68
22252-312-375-NYB-VI	QJ300 DOUBLE BODY SUB ASM, QJ312, VITON	13.82	23120-1/2-PP	PRES.RELIEF VALVE PP	51.91
22252-312-375-PP	QJ300 DOUBLE VARI-QUICK S/ASB.PP	24.89	23120-1/2-PP-60	PRES.RELIEF VALVE 60 PSI	51.91
22252-312-500-MC	QJ300 DOUBLE W MNL CHMSVR	21.11	23120-1/2-PP-60-VI	PRES.RELIEF VALVE PP 60 PSI	78.38
22252-312-500-NYB	QJ300 DOUBLE VARI-QUICK SUB-ASB.	12.33	23120-3/4-PP	PRES.RELIEF VALVE PP	51.91
22252-312-500-NYB-VI	QJ300 DOUBLE BODY SUB ASM, QJ312, VITON	13.82	23120-3/4-PP-60	PRES.RELIEF VALVE 60 PSI	51.91
22252-312-500-PP	QJ300 DOUBLE VARI-QUICK S/ASB.PP	24.89	23120-3/4-PP-60-VI	PRES.RELIEF VALVE PP 60 PSI	78.38
22252-312-750-MC	QJ300 DOUBLE W MNL CHMSVR	21.11	23120A-1/2-PP	PRES.RELIEF VALVE PP	78.38
22252-312-750-NYB	QJ300 DOUBLE VARI-QUICK SUB-ASB.	12.33	23120A-3/4-PP	PRES.RELIEF VALVE PP	78.38
22252-312-750-NYB-VI	QJ300 DOUBLE BODY SUB ASM, QJ312, VITON	13.82	23168-HSS	ADJ.CONEJET SUB-ASB	70.63
22252-312-750-PP	QJ300 DOUBLE VARI-QUICK S/ASB.PP	24.89	23170-1-122-1/2	1/2" NPT LESS SCREEN	17.48
22426-18	EXTENSION ASB.AA30L	79.81	23170-1-122-3/4	3/4" NPT LESS SCREEN	17.48
22426-24	EXTENSION ASB.AA30L	85.96	23170-1-122-3/4-NYC	3/4" NPT LESS SCREEN	24.39
22426-36	EXTENSION ASB.AA30L	96.28	23170-1-B122-1/2	1/2" BSPT LESS SCRNR	17.48
22426-48	EXTENSION ASB.AA30L	223.30	23170-1-B122-3/4	3/4" BSPT LESS SCREEN	17.48
22426-8	EXTENSION ASB.AA30L	69.53	23209-1-31	INSERT SUB AS L/STRN	27.11
22470A-1/4	ISOLATOR ASSEMBLY	128.17	23209-1-35	INSERT SUB-AS.L/STRN	27.11
22470A-1/4NPTX1/4BSPT	ISOLATOR KIT	128.28	23209-1-42	INSERT SUB-AS.L/STRN	27.11
22470A-1/8	ISOLATOR ASSEMBLY	128.17	23209-1-52	INSERT SUB-AS.L/STRN	27.11
22570-PP-15-1/4	TRIGGERJET W/EXT. PP	59.31	23209-1-62	INSERT SUB-AS.L/STRN	27.11
22570-PP-15-1/4-X18	TRIGGERJET WITH X18	65.88	23209-16	INSERT SUB.W/100MSTR	36.73
22570-PP-15-300	TRIGGERJET W/EXT. PP	59.31	23209-2-20	INSERT SUB W/50M STR	36.73
22570-PP-15-300-X18	TRIGGERJET WITH X18	65.88	23209-2-26	INSERT SUB W/50M STR	36.73
22570-PP-15-406	TRIGGERJET W/EXT. PP	59.31	23209-2-31	INSERT SUB W/50M STR	36.73
22570-PP-15-406-X18	TRIGGERJET WITH X18	65.88	23209-2-35	INSERT SUB W/50M STR	36.73
22570-PP-24-1/4	TRIGGERJET W/EXT. PP	69.11	23209-2-42	INSERT SUB W/50M STR	36.73
22570-PP-24-1/4-X18	TRIGGERJET WITH X18	75.94	23209-2-62	INSERT SUB W/50M STR	36.73
22570-PP-24-1/4-X26	TRIGGERJET WITH X26	75.94	23209-20	INSERT SUB W/100MSTR	36.73
22570-PP-24-300	TRIGGERJET W/EXT. PP	69.11	23209-26	INSERT SUB.W/100MSTR	36.73
22570-PP-24-300-X18	TRIGGERJET WITH X18	75.94	23209-31	INSERT SUB-AS.W/STRN	36.73
22570-PP-24-406	TRIGGERJET W/EXT. PP	69.11	23220-1/4FX1/4F	PLUG VALVE ASB.BRASS	32.84
22570-PP-24-406-X18	TRIGGERJET WITH X18	75.94	23220-1/4FX1/4M	PLUG VALVE ASB.BRASS	32.84
22650-1-PP-406-X18	TRIGGERJET 3/8 SPRAYGUN CONEJET 18	54.74	23220-1/4FXT	PLUG VALVE ASB.BRASS	32.84
			23220-1/4MX1/4F	PLUG VALVE ASB.BRASS	32.84
			23220-1/4MXT	PLUG VALVE ASB.BRASS	32.84
			23220-1/8FX1/8F	PLUG VALVE ASB.BRASS	32.84
			23240-3-316SS-5.7-316SS	KEG WASHING NOZ 316S	977.93
			23240-3-316SS-7-316SS	KEG WASHING NOZ.316S	1017.19
			23306H-1-CELR	Q.T.CAP&GASKET SUB-ASB BLACK	1.85
			23306H-10-CELR	Q.T.CAP&GASKET SUB-ASB VIOLET	1.85
			23306H-2-CELR	Q.T.CAP&GASKET SUB-ASB WHITE	1.85
			23306H-3-CELR	Q.T.CAP&GASKET SUB-ASB RED	1.85
			23306H-4-CELR	Q.T.CAP&GASKET SUB-ASB BLUE	1.85
			23306H-5-CELR	Q.T.CAP&GASKET SUB-ASB GREEN	1.85
			23306H-6-CELR	Q.T.CAP&GASKET SUB-ASB YELLOW	1.85

PART NO.	DESCRIPTION	U.S.DOLLARS	PART NO.	DESCRIPTION	U.S.DOLLARS
23306H-7-CELR	Q.T.CAP&GASKET SUB-ASB BROWN	1.85	24216A-3/4-NYB	TURRET NOZZLE	17.55
23306H-8-CELR	Q.T.CAP&GASKET SUB-ASB ORANGE	1.85	24216A-3/4-NYB-VI	24216A TURRET NOZZLE VITON	19.54
23520-1/2-PP	THROTTLING VALVE PP	44.98	24217-1-CE	QT BODY&INDEX PLATE	16.69
23520-3/4-PP	THROTTLING VALVE PP	44.98	24230A-1-406-NYB	QT HOSESHK,TRIPLE NZ	32.02
23535-1	MANUAL VALVE MANIFOLD WITH STR	496.23	24230A-1-540-NYB	QT HOSESHK,TRIPLE NZ	32.02
23535-4	MANUAL VALVE MANIFOLD W/ STR	637.40	24230A-1-785-NYB	QT HOSESHK,TRIPLE NZ	32.02
23600-1	METERJET ASSEMBLY	124.38	24230A-2-406-NYB	QT HOSESHK,TRIPLE NZ	32.02
23600-2	METERJET ASSEMBLY	124.38	24230A-2-540-NYB	QT HOSESHK,TRIPLE NZ	32.02
23600L-1	METERJET ASSEMBLY	124.38	24230A-2-785-NYB	QT HOSESHK,TRIPLE NZ	32.02
23600L-2	METERJET ASSEMBLY	124.38	24230A-3-406-NYB	QT HOSESHK,TRIPLE NZ	32.02
23621-COMMAT	MAIN STEM SUB-ASB.	32.06	24230A-3-540-NYB	QT HOSESHK,TRIPLE NZ	32.02
23622-COMMAT	MAIN STEM SUB-ASB.	31.75	24230A-3-785-NYB	QT HOSESHK,TRIPLE NZ	32.02
23623-31	GUNJET SPRAY GUN	197.99	24231A-1-NYB	BODY SUB-ASB.24230	32.90
23623-31-1/4F	GUNJET SPRAY GUN	197.99	24231A-1-VI	BODY SUB-ASB. 24230, VITON	47.10
23623L-31	GUNJET SPRAY GUN	197.99	24231A-NYB	BODY SUB-ASB.24230	32.90
23623L-31-1/4F	GUNJET SPRAY GUN	197.99	24231A-VI	BODY SUB-ASB. 24230, VITON	47.10
23624-30L-1/4	GUNJET SPRAY GUN	217.94	25596-1-NYR	Q.T.BLACK CAP&GASKET S-ASB	1.79
23624L-30L-1/4	GUNJET SPRAY GUN	217.94	25596-2-NYR	Q.T.WHITE CAP&GASKET S-ASB	1.79
23770-SS	ROW APPLICATOR KT,SS	117.61	25596-3-NYR	Q.T.RED CAP&GASKET S-ASB	1.79
23800A-1/4	ISOLATOR KIT AA744	169.75	25596-4-NYR	Q.T.BLUE CAP&GASKET S-ASB	1.79
23800A-1/8	ISOLATOR KIT,AA744	169.75	25596-5-NYR	Q.T.GREEN CAP&GASKET S-ASB	1.79
23830	DOUBLE ROLLOVER VLV.	45.10	25596-6-NYR	Q.T.YELLOW CAP&GASKET S-ASB	1.79
23830-1/4F	DOUBLE ROLLOVER VLV.	45.10	25596-7-NYR	Q.T.BROWN CAP&GASKET S-ASB	1.79
23830-1/4F-VI	DBL ROLLOVER VLV.VI	51.57	25596-8-NYR	Q.T.ORANGE CAP&GASKET S-ASB	1.79
23830-1/4M	DOUBLE ROLLOVER VLV.	45.10	25600-1-NYR	Q.T.BLACK CAP&GASKET S-ASB	1.79
23830-1/4M-VI	DBL ROLLOVER VLV.VI	51.57	25600-2-NYR	Q.T.WHITE CAP&GASKET S-ASB	1.79
23830-VI	DBL ROLLOVER VLV. VI	51.57	25600-3-NYR	Q.T.RED CAP&GASKET S-ASB	1.79
23831	SINGLE ROLLOVER VLV.	40.80	25600-4-NYR	Q.T.BLUE CAP&GASKET S-ASB	1.79
23831-1/4F	SINGLE ROLLOVER VLV.	40.80	25600-5-NYR	Q.T.GREEN CAP&GASKET S-ASB	1.79
23831-1/4F-VI	SIGL ROLLOVER VLV,VI	47.25	25600-6-NYR	Q.T.YELLOW CAP&GASKET S-ASB	1.79
23831-1/4M	SINGLE ROLLOVER VLV.	40.80	25600-7-NYR	Q.T.BROWN CAP&GASKET S-ASB	1.79
23831-1/4M-VI	SGLE ROLLOVER VLV,VI	47.25	25600-8-NYR	Q.T.ORANGE CAP&GASKET S-ASB	1.79
23831-VI	SNGL ROLLOVER VLV,VI	47.25	25608-9-PP	QT GRAY CAP&GASKET POLYPR	1.79
23990-1/4-055	ADJUSTABLE WASHJET	57.81	25610-1-NYR	Q.T.BLACK CAP&GASKET S-ASB	1.79
23990-1/4-06	ADJUSTABLE WASHJET	57.81	25610-2-NYR	Q.T.WHITE CAP&GASKET S-ASB	1.79
24216A-1-AC3	TURRET NOZZLE W/55300 AIR CHMSVR	64.66	25610-3-NYR	Q.T.RED AP&GASKET S-ASB	1.79
24216A-1-NYB	TURRET NOZZLE	17.55	25610-4-NYR	Q.T.BLUE CAP&GASKET S-ASB	1.79
24216A-1-NYB-VI	24216A TURRET NOZZLE VITON	19.54	25610-5-NYR	Q.T.GREEN CAP&GASKET S-ASB	1.79
24216A-1/2-AC3	TURRET NOZZLE W/55300 AIR CHMSVR	64.66	25610-6-NYR	Q.T.YELLOW CAP&GASKET S-ASB	1.79
24216A-1/2-NYB	TURRET NOZZLE	17.55	25610-7-NYR	Q.T.BROWN CAP&GASKET S-ASB	1.79
24216A-1/2-NYB-VI	24216A TURRET NOZZLE VITON	19.54	25610-8-NYR	Q.T.ORANGE CAP&GASKET S-ASB	1.79
24216A-1/2M-AC3	TURRET NOZZLE W/55300 AIR CHMSVR	64.66	25612-9-PP	QT GRAY CAP & GASKET POLYPR	1.79
24216A-1/2M-NYB	TURRET NOZZLE	17.55	25657-NYB	ADAPTER,25660	32.65
24216A-1/2M-NYB-VI	24216A TURRET NOZZLE VITON	19.54	25660-0	GUNJET LESS NOZZLE	129.38
24216A-1/2X7-AC3	TURRET NOZZLE W/55300 AIR CHMSVR	64.66	25660-1-4.0	GUNJET SPRAY GUN W/ 25990-3_4 INLET	166.82
24216A-1/2X7-NYB	TURRET NOZZLE	17.55	25660-1.5	GUNJET SPRAY GUN	147.72
24216A-1/2X7-NYB-VI	24216A TURRET NOZZLE VITON	19.54	25660-3.0	GUNJET SPRAY GUN	147.72
24216A-20MM-AC3	TURRET NOZZLE W/55300 AIR CHMSVR	64.66	25660-4.0	GUNJET SPRAY GUN	147.72
24216A-20MM-NYB	TURRET NOZZLE	17.55	25663	SEATING SUB-ASB. 4/25660	9.76
24216A-20MM-NYB-VI	24216A TURRET NOZZLE VITON	19.54	25675-NY	TRIGGER SUB-ASSEMBLY NYLON	29.15
24216A-20MMX7-AC3	TURRET NOZZLE W/55300 AIR CHMSVR	64.66	25775-1/2T-NYB	EYELET CONNECTER ASB	8.24
24216A-20MMX7-NYB	TURRET NOZZLE	17.55	25775-1/2T-NYB-VI	EYELET CONNECTOR ASB, VITON	8.70
24216A-20MMX7-NYB-VI	24216A TURRET NOZZLE VITON	19.54	25775-1T-NYB	EYELET CONNECTER ASB	8.24
24216A-3/4-AC3	TURRET NOZZLE W/55300 AIR CHMSVR	64.66	25775-1T-NYB-VI	EYELET CONNECTOR ASB, VITON	8.70
			25775-3/4T-NYB	EYELET CONNECTER ASB	8.24
			25775-3/4T-NYB-VI	EYELET CONNECTOR ASB, VITON	8.70
			25788-3/8F	ADAPTER	8.08
			25888-1-NYB	EYELET CONNECTER ASB	10.35
			25888-1/2-NYB	EYELET CONNECTER ASB	10.35
			25888-3/4-NYB	EYELET CONNECTER ASB	10.35
			25990-3/4-NYB	SWIVEL ASB NYLON	19.14
			25990-GGH-NYB	SWIVEL ASB NYLON	19.14
			26278-1-NYR	Q.T.BLACK CAP&GASKET S-ASB	1.94



PART NO.	DESCRIPTION	U.S.DOLLARS	PART NO.	DESCRIPTION	U.S.DOLLARS
26278-3-NYR	Q.T.RED CAP&GASKET S-ASB	1.94	344BE-23-C15	SHUTOFF VALVE 3/4"	475.41
26324-144F	DIRECTOVALVE	266.35	344BE-23-C15OB	SHUTOFF VALVE 3/4"	497.37
27500E-3/4-18-TEF	TANK WASH NOZ.TEFLON	367.10	344BE-23-CLB	SHUTOFF VALVE 3/4"	482.97
3/4ATW-B100	STRAINER,BRASS	145.77	344BE-23-COB	SHUTOFF VALVE 3/4"	482.97
3/4ATW-B16	STRAINER,BRASS	145.77	344BE-23-CPG	SHUTOFF VALVE 3/4"	482.97
3/4ATW-B200	STRAINER,BRASS	145.77	344BE-23-D	SHUTOFF VALVE 3/4	461.07
3/4ATW-B30	STRAINER,BRASS	145.77	344BE-23S-C	SHUTOFF VALVE SS 3/4	583.62
3/4ATW-B50	STRAINER,BRASS	145.77	344BE-24-C	SHUTOFF VALVE 1"	461.07
3/4ATW-B80	STRAINER,BRASS	145.77	344BE-24-C15OG	SHUTOFF VALVE 1"	497.37
3/4K-100	FLOODJET NOZ.,BRASS	45.55	344BE-24-CJ	SHUTOFF VALVE 1"	472.13
3/4K-110	FLOODJET NOZ.,BRASS	45.55	344BE-24-COB	SHUTOFF VALVE 1"	482.97
3/4K-120	FLOODJET NOZ.,BRASS	45.55	344BE-24-COC	SHUTOFF VALVE 1"	482.97
3/4K-140	FLOODJET NOZ. BRASS	84.00	344BE-24-CPS	SHUTOFF VALVE 1"	482.97
3/4K-160	FLOODJET NOZ. BRASS	84.00	344BE-24-CUA	SHUTOFF VALVE 1"	482.97
3/4K-180	FLOODJET NOZ.,BRASS	84.00	344BE-24-CVX	SHUTOFF VALVE 1"	482.97
3/4K-210	FLOODJET NOZ.,BRASS	84.00	344BE-24-D	SHUTOFF VALVE 1"	461.07
3/4K-90	FLOODJET NOZ.,BRASS	45.55	344BE-24S-C	SHUTOFF VALVE SS 1"	583.62
3/4K-SS100	FLOODJET NOZ.,ST.STL	63.58	344BE-24S-CPG	SHUTOFF VALVE SS 1"	621.87
3/4K-SS110	FLOODJET NOZ.,ST.STL	63.58	344BE-24S-CPS	SHUTOFF VALVE SS 1"	621.87
3/4K-SS120	FLOODJET NOZ.,ST.STL	63.58	344BE-24S-D	SHUTOFF VALVE SS 1"	583.62
3/4K-SS140	FLOODJET NOZ.,ST.STL	114.36	344BE-2F-C	SHUTOFF VALVE FLANGE	461.07
3/4K-SS160	FLOODJET NOZ.,ST.STL	114.36	344BE-2F-CUB	SHUTOFF VALVE FLANGE	482.97
3/4K-SS180	FLOODJET NOZ.,ST.STL	114.36	344BE-2F-D	SHUTOFF VALVE 50F	461.07
3/4K-SS210	FLOODJET NOZ.,ST.STL	114.36	344BE-2F-P	SHUTOFF VALVE 50F LESS CABLE	439.66
3/4K-SS80	FLOODJET NOZ.,ST.STL	63.58	344BE-2FS-D	SHUTOFF VALVE SS 50F	583.62
3/4K-SS90	FLOODJET NOZ.,ST.STL	63.58	344BE-33-C	SHUTOFF/BYPASS 3/4"	564.25
3/4KLC-108	FIELDJET NOZ.,BRASS	88.27	344BE-33-C03	SHUTOFF/BYPASS 3/4"	564.25
3/4KLC-50	FIELDJET NOZ.,BRASS	88.27	344BE-33-CN	SHUTOFF/BYPASS NEG 3/4"	564.25
3/4KLC-72	FIELDJET NOZ.,BRASS	88.27	344BE-33-CPG	SHUTOFF/BYPASS 3/4"	586.23
3/4KLC-SS108	FIELDJET NOZ.,ST.STL	129.71	344BE-33-D	SHUTOFF/BYPASS 3/4	564.25
3/4KLC-SS50	FIELDJET NOZ.,ST.STL	129.71	344BE-33S-C	SHUTOFF/BYPASS SS3/4	686.89
3/4KLC-SS72	FIELDJET NOZ.,ST.STL	129.71	344BE-34-C	SHUTOFF/BYPASS 1"	564.25
3/4Q-100	STRAINER,BRASS	96.32	344BE-34-D	SHUTOFF/BYPASS 1"	564.25
3/4Q-16	STRAINER,BRASS	96.32	344BE-34S-C	SHUTOFF/BYPASS SS 1"	686.89
3/4Q-50	STRAINER,BRASS	96.32	344BE-3F-C60TU	SHUTOFF/BYPASS 50F	605.45
3/4QPW-100	STRAINER,STAINLESS	25.72	344BE-3F-D	SHUTOFF/BYPASS 50F	564.25
3/4QPW-24	STRAINER,STAINLESS	25.72	344BE-3QS-D	SHUTOFF/BYPASS SS Q	686.89
3/4QPW-50	STRAINER,STAINLESS	25.72	344BEC-23-C	SHUTOFF VALVE 3/4"	461.07
3/4TW-100	STRAINER,CAST IRON	247.06	344BEC-23-C03J	SHUTOFF VALVE 3/4"	472.01
3/4TW-16	STRAINER,CAST IRON	247.06	344BEC-23-C03OB	SHUTOFF VALVE 3/4"	482.97
3/4TW-200	STRAINER,CAST IRON	247.06	344BEC-23-C03OC	SHUTOFF VALVE 3/4"	482.97
3/4TW-30	STRAINER,CAST IRON	247.06	344BEC-23-C15	SHUTOFF VALVE 3/4"	475.41
3/4TW-50	STRAINER,CAST IRON	247.06	344BEC-23-C15VX	SHUTOFF VALVE 3/4	497.37
3/4TW-80	STRAINER,CAST IRON	247.06	344BEC-23-C60	SHUTOFF VALVE 3/4	514.11
3/4TW-B100	STRAINER,BRASS	625.29	344BEC-23-CJ	SHUTOFF VALVE 3/4"	472.01
3/4TW-B16	STRAINER,BRASS	625.29	344BEC-23-CK	SHUTOFF VALVE 3/4"	472.01
3/4TW-B200	STRAINER,BRASS	625.29	344BEC-23-CN	SHUTOFF NEG VLV 3/4"	461.07
3/4TW-B30	STRAINER,BRASS	625.29	344BEC-23-CN15	SHUTOFF VALVE 3/4"	475.41
3/4TW-B50	STRAINER,BRASS	625.29	344BEC-23-CN15PG	SHUTOFF NEG VLV 3/4"	497.37
3/4TW-B80	STRAINER,BRASS	625.29	344BEC-23-COC	SHUTOFF VALVE 3/4"	482.97
3/8K-30	FLOODJET NOZ.,BRASS	19.76	344BEC-23-COG	SHUTOFF VALVE 3/4"	482.97
3/8K-35	FLOODJET NOZ.,BRASS	19.76	344BEC-23-CPC	SHUTOFF VALVE 3/4"	482.97
3/8K-40	FLOODJET NOZ.,BRASS	19.76	344BEC-23-CPG	SHUTOFF VALVE 3/4"	482.97
3/8K-45	FLOODJET NOZ.,BRASS	19.76	344BEC-23-CQB	SHUTOFF VALVE 3/4"	482.97
3/8K-SS30	FLOODJET NOZ.,ST.STL	38.59	344BEC-23-CVX	SHUTOFF VALVE 3/4"	482.97
3/8K-SS35	FLOODJET NOZ.,ST.STL	38.59	344BEC-23-D	SHUTOFF VALVE 3/4"	461.07
3/8K-SS40	FLOODJET NOZ.,ST.STL	38.59	344BEC-23-DN	SHUTOFF VALVE 3/4"	461.07
3/8K-SS45	FLOODJET NOZ.,ST.STL	38.59	344BEC-23-P	SHUTOFF VALVE 3/4" LESS CABLE	439.66
3/8PT	TEEJET EYELET ASB,BR	39.50	344BEC-23S-C	SHUTOFF VALVE SS 3/4	583.62
3056-1/2	ADAPTER,GHT,BRASS	15.58	344BEC-23S-C60	SHUTOFF VALVE SS 3/4	636.69
3056-1/4	ADAPTER,GHT,BRASS	15.58	344BEC-23S-CN15	SHUTOFF VALVE SS 3/4	597.99
3056-1/8	ADAPTER,GHT,BRASS	15.58	344BEC-23S-CN60	SHUTOFF VALVE SS 3/4	636.69
3056-3/8	ADAPTER,GHT,BRASS	15.58	344BEC-23S-COC	SHUTOFF VALVE SS 3/4	605.62
344BE-23-C	SHUTOFF VALVE 3/4"	461.07	344BEC-23S-COG	SHUTOFF VALVE SS 3/4	605.62



# COMPREHENSIVE LIST

PART NO.	DESCRIPTION	U.S.DOLLARS	PART NO.	DESCRIPTION	U.S.DOLLARS
344BEC-23S-COK	SHUTOFF VLVE SS 3/4	605.62	344BEC-2Q-CN	SHUTOFF VALVE QC NEG	461.07
344BEC-23S-CPC	SHUTOFF VALVE SS 3/4	605.62	344BEC-2Q-D	SHUTOFF VALVE QC	461.07
344BEC-23S-CUX	SHUTOFF VALVE SS 3/4	605.62	344BEC-2QS-CJ	SHUTOFF VALVE SS QC	594.70
344BEC-23S-CVX	SHUTOFF VALVE SS 3/4	605.62	344BEC-2QS-D	SHUTOFF VALVE SS QC	583.62
344BEC-23S-D	SHUTOFF VALVE SS 3/4	583.62	344BEC-33-C	SHUTOFF/BYPASS 3/4"	564.25
344BEC-23S-Q	SHUTOFF VALVE SS 3/4	583.62	344BEC-33-C03	SHUTOFF/BYPASS 3/4"	564.25
344BEC-24-C	SHUTOFF VALVE 1"	461.07	344BEC-33-C03OG	SHUTOFF/BYPASS 3/4"	586.23
344BEC-24-C03	SHUTOFF VALVE 1"	461.07	344BEC-33-C15	SHUT OFF BYPASS	578.60
344BEC-24-C03J	SHUTOFF VALVE 1"	472.01	344BEC-33-C15VX	SHUTOFF/BYPASS 3/4"	600.58
344BEC-24-C15TU	SHUTOFF VALVE 1"	497.37	344BEC-33-C60	SHUTOFF/BYPASS 3/4"	617.32
344BEC-24-C60	SHUTOFF VALVE 1"	514.11	344BEC-33-CJ	SHUTOFF/BYPASS 3/4"	575.30
344BEC-24-CJ	SHUTOFF VALVE 1"	472.01	344BEC-33-CK	SHUT OFF BYPASS	575.30
344BEC-24-CK	SHUTOFF VALVE 1"	472.01	344BEC-33-CN	SHUTOFF/BYPASS 3/4"	564.25
344BEC-24-CN	SHUTOFF VALVE 1"	461.07	344BEC-33-COB	SHUTOFF/BYPASS 3/4"	586.23
344BEC-24-COB	SHUTOFF VALVE 1"	482.97	344BEC-33-COC	SHUTOFF / BYPASS 3/4"	586.23
344BEC-24-COC	SHUTOFF VALVE 1"	482.97	344BEC-33-CPB	SHUTOFF/BYPASS 3/4"	586.23
344BEC-24-CPC	SHUTOFF VALVE 1"	482.97	344BEC-33-CPC	SHUTOFF/BYPASS 3/4"	586.23
344BEC-24-CPG	SHUTOFF VALVE 1"	482.97	344BEC-33-COC	SHUTOFF/BYPASS 3/4"	586.23
344BEC-24-CPU	SHUTOFF VALVE 1"	482.97	344BEC-33-CUX	SHUTOFF/BYPASS 3/4"	586.23
344BEC-24-CSB	SHUTOFF VALVE 1"	482.97	344BEC-33-CVX	SHUTOFF/BYPASS 3/4"	586.23
344BEC-24-CUX	SHUTOFF VALVE 1"	482.97	344BEC-33-D	SHUTOFF/BYPASS 3/4"	564.25
344BEC-24-CVG	SHUTOFF VALVE 1"	482.97	344BEC-33-P	Shutoff/Bypass 3/4" Less Cable	565.30
344BEC-24-CVX	SHUTOFF VALVE 1"	482.97	344BEC-33S-C	SHUTOFF/BYPASS SS 3/4"	686.89
344BEC-24-D	SHUTOFF VALVE 1"	461.07	344BEC-33S-C15	SHUTOFF/BYPASS SS 3/4"	701.26
344BEC-24-DN	SHUTOFF VALVE 1"	461.07	344BEC-33S-C60	SHUTOFF/BYPASS SS 3/4"	739.93
344BEC-24-P	SHUTOFF VALVE 1" LESS CABLE	439.66	344BEC-33S-COB	SHUTOFF/BYPASS SS 3/4"	708.88
344BEC-24S-C	SHUTOFF VALVE SS 1"	583.62	344BEC-33S-D	SHUTOFF/BYPASS SS 3/4"	686.89
344BEC-24S-C03	SHUTOFF VALVE SS 1"	583.62	344BEC-34-C	SHUTOFF/BYPASS 1"	564.25
344BEC-24S-C15	SHUTOFF VALVE SS 1"	598.00	344BEC-34-C03	SHUTOFF/BYPASS 1"	564.25
344BEC-24S-C60	SHUTOFF VALVE SS 1"	636.69	344BEC-34-C60	SHUTOFF/BYPASS 3/4"	617.32
344BEC-24S-C60TU	SHUTOFF VALVE SS 1"	658.64	344BEC-34-C60VX	SHUTOFF/BYPASS 3/4"	639.25
344BEC-24S-CK	SHUTOFF VALVE SS 1"	609.05	344BEC-34-CJ	SHUTOFF/BYPASS 1"	575.30
344BEC-24S-CN	SHUTOFF VALVE SS 1"	583.62	344BEC-34-CN	SHUTOFF/BYPASS 1"	564.25
344BEC-24S-CN15	SHUTOFF VALVE SS 1"	597.99	344BEC-34-CN15	SHUTOFF/BYPASS 1"	578.60
344BEC-24S-COB	SHUTOFF VALVE SS 1"	605.62	344BEC-34-COB	SHUTOFF/BYPASS 1"	586.23
344BEC-24S-COC	SHUTOFF VALVE SS 1"	605.62	344BEC-34-COC	SHUTOFF/BYPASS 1"	586.23
344BEC-24S-CVX	SHUTOFF VALVE SS 1"	605.62	344BEC-34-COG	SHUTOFF/BYPASS 1"	586.23
344BEC-24S-P	SHUTOFF VALVE SS 1" LESS CABLE	562.23	344BEC-34-CPB	SHUTOFF/BYPASS 1"	586.23
344BEC-2F-C	SHUTOFF VALVE 50F	461.07	344BEC-34-CPC	SHUTOFF/BYPASS 1"	586.23
344BEC-2F-C03	SHUTOFF VALVE 50F	461.07	344BEC-34-CPS	SHUTOFF/BYPASS 1"	586.23
344BEC-2F-C03VX	SHUTOFF VALVE 50F	482.97	344BEC-34-CPU	SHUTOFF/BYPASS 1"	586.23
344BEC-2F-C15	SHUTOFF VALVE 50F	475.41	344BEC-34-CVX	SHUTOFF/BYPASS 1"	586.23
344BEC-2F-CJ	SHUTOFF VALVE 50F	472.01	344BEC-34-D	SHUTOFF/BYPASS 1"	564.25
344BEC-2F-COB	SHUTOFF VALVE 50F	482.97	344BEC-34S-C	SHUTOFF/BYPASS SS 1"	686.89
344BEC-2F-COC	SHUTOFF VALVE 50F	482.97	344BEC-34S-C15	SHUTOFF/BYPASS SS 1"	701.26
344BEC-2F-CPB	SHUTOFF VALVE 50F	482.97	344BEC-34S-C60	SHUTOFF/BYPASS SS 1"	739.93
344BEC-2F-CPU	SHUTOFF VALVE 50F	482.97	344BEC-34S-CJ	SHUTOFF/BYPASS SS 1"	697.88
344BEC-2F-CQB	SHUTOFF VALVE 50F	482.97	344BEC-34S-CN	SHUTOFF/BYPASS SS 1"	686.89
344BEC-2F-CUX	SHUTOFF VALVE 50F	482.97	344BEC-34S-D	SHUTOFF/BYPASS SS 1"	686.89
344BEC-2F-CVX	SHUTOFF VALVE 50F	482.97	344BEC-3F-C	SHUTOFF/BYPASS 50F	564.25
344BEC-2F-CWR	SHUTOFF VALVE 50F	482.97	344BEC-3F-C15	SHUTOFF/BYPASS 50F	578.60
344BEC-2F-D	SHUTOFF VALVE 50F	461.07	344BEC-3F-C60	SHUTOFF/BYPASS 50F	617.32
344BEC-2FS-C	SHUTOFF VALVE SS 50F	583.62	344BEC-3F-C60OU	SHUTOFF/BYPASS 50F	639.27
344BEC-2FS-C15	SHUTOFF VALVE SS 50F	597.69	344BEC-3F-COC	SHUTOFF/BYPASS 50F	586.23
344BEC-2FS-C60	SHUTOFF VALVE SS 50F	679.15	344BEC-3F-CPB	SHUTOFF/BYPASS 50F	586.24
344BEC-2FS-CN15AB	SHUTOFF VALVE SS 50F	605.62	344BEC-3F-CPC	SHUTOFF VALVE 50F	575.30
344BEC-2FS-CN15J	SHUTOFF NEG VLV SS 50F	609.05	344BEC-3F-D	SHUTOFF/BYPASS 50F	564.25
344BEC-2FS-CVR	SHUTOFF VALVE SS 50F	605.62	344BEC-3F-DN	SHUTOFF/BYPASS 50F	564.25
344BEC-2FS-CVX	SHUTOFF VALVE SS 50F	605.62	344BEC-3FS-C	SHUTOFF/BYPASS SS50F	686.89
344BEC-2FS-CWR	SHUTOFF VALVE 50F SS	605.62	344BEC-3FS-C03OG	SHUTOFF/BYPASS SS50F	708.83
344BEC-2FS-CWX	SHUTOFF VALVE 50F SS	605.62	344BEC-3FS-COC	SHUTOFF/BYPASS SS50F	708.83
344BEC-2FS-D	SHUTOFF VALVE SS 50F DIN	583.62	344BEC-3FS-COG	SHUTOFF/BYPASS SS50F	708.83
344BEC-2Q-C	SHUTOFF VALVE QC	461.07	344BEC-3FS-D	SHUTOFF/BYPASS SS50F	686.89
			344BEC-3Q-C	SHUTOFF/BYPASS 50F	564.25

PART NO.	DESCRIPTION	U.S.DOLLARS	PART NO.	DESCRIPTION	U.S.DOLLARS
344BEC-3Q-CN	SHUTOFF/BYPASS QC NEG	564.25	344BPR-33-03C60	3RPM 12SEC PR REG	508.22
344BEC-3Q-COC	SHUTOFF/BYPASS QC	586.23	344BPR-33-03CCS	3RPM 12SEC PR REG	477.15
344BEC-3Q-CVE	SHUTOFF/BYPASS QC	586.23	344BPR-33-03CEC	3RPM 12SEC PR REG	477.15
344BEC-3Q-D	SHUTOFF/BYPASS 50F	564.25	344BPR-33-03CUK	3RPM 12SEC PR REG	477.15
344BEC-3QS-C	SHUTOFF VALVE SS	686.89	344BPR-33-06C	6RPM 6SEC PR REG	455.20
344BEC-3QS-DN	SHUTOFF/BYPASS SS QC	686.89	344BPR-33-06C15	6RPM 3SEC PR REG	469.60
344BEC-BF-D	SHUTOFF VALVE F50	493.16	344BPR-33-06C60	6RPM 3SEC PR REG	508.22
344BEC-BQ-D	SHUTOFF VALVE QC	493.16	344BPR-33-06CCS	6RPM 3SEC PR REG	477.15
344BLPR-33S-06C	LF 6RPM 3SEC	568.41	344BPR-33-06CFC	6RPM 6SEC PR REG	477.15
344BPR-23-01C	1RPM 36SEC PR REG	455.20	344BPR-33-06CUB	6RPM 6SEC PR REG	477.15
344BPR-23-01C15	1RPM 36SEC PR REG	476.00	344BPR-33-06CUG	6RPM 6SEC PR REG	477.15
344BPR-23-01CCC	1RPM 36SEC PR REG	477.15	344BPR-33-06CUK	6RPM 6SEC PR REG	477.15
344BPR-23-01CCS	1RPM 36SEC PR REG	477.15	344BPR-33-06D	6RPM 6SEC PR REG	455.20
344BPR-23-01CEC	1 RPM 36SEC PR REG	477.15	344BPR-34-01C	1RPM 36SEC PR REG	455.20
344BPR-23-01CES	1RPM 36SEC PR REG	477.15	344BPR-34-03C	3RPM 12SEC PR REG	455.20
344BPR-23-01CFC	1RPM 36SEC PR REG	477.15	344BPR-34-03C60	3RPM 12SEC PR REG	508.22
344BPR-23-01CVX	1RPM 36SEC PR REG	477.15	344BPR-34-03CCS	3RPM 12SEC PR REG	477.15
344BPR-23-01D	1 RPM 36SEC PR REG	455.20	344BPR-34-03CFC	3RPM 12SEC PR REG	477.15
344BPR-23-03C	3RPM 12SEC PR REG	455.20	344BPR-34-03CSC	3RPM 12SEC PR REG	477.15
344BPR-23-03C15	3RPM 12SEC PR REG	476.00	344BPR-34-03D	3RPM 12SEC PR REG	455.20
344BPR-23-03CCC	3RPM 12SEC PR REG	477.15	344BPR-34-06C	6RPM 6SEC PR REG	455.20
344BPR-23-03CCS	3RPM 12SEC PR REG	477.15	344BPR-34-06CCS	6RPM 2SEC PR REG	477.15
344BPR-23-03CEC	3RPM 12SEC PR REG	477.15	344BPR-34-06CFC	6RPM 2SEC PR REG	477.15
344BPR-23-03CES	3RPM 12SEC PR REG	477.15	344BPR-34-06CUG	6RPM 6SEC PR REG	477.15
344BPR-23-03D	3RPM 12SEC PR REG	455.20	344BPR-3F-01C	3RPM 12SEC PR REG	455.20
344BPR-23-06C	6RPM 6SEC PR REG	455.20	344BPR-3F-03C	3RPM 12 SEC PR REG	455.20
344BPR-23-06CCS	6RPM 6SEC PR REG	477.15	344BPR-3F-03CCS	3RPM 12SEC PR REG	477.15
344BPR-23-06CFC	6RPM 6SEC PR REG	477.15	344BPR-3F-03CGC	3RPM 12SEC PR REG	477.15
344BPR-24-01C	1RPM 36SEC PR REG	455.20	344BPR-3F-03D	3RPM 12SEC PR REG	455.20
344BPR-24-01CCC	1RPM 36SEC PR REG	477.15	344BPR-3F-06	6RPM 6SEC PR REG LESS CABLE	413.13
344BPR-24-01CCS	1RPM 36SEC PR REG	477.15	344BPR-3F-06C	6RPM 6SEC PR REG	455.20
344BPR-24-01CGC	1RPM 36SEC PR REG	477.15	344BPR-3F-06C15	6RPM 6SEC PR REG	469.60
344BPR-24-01D	1RPM 36SEC PR REG	455.20	344BPR-3F-06CCS	6RPM 6SEC PR REG	477.15
344BPR-24-03C	3RPM 12SEC PR REG	455.20	344BPR-3F-06CUG	6RPM 6SEC PR REG	477.15
344BPR-24-03CCC	3RPM 12SEC PR REG	477.15	344BPR-3F-06D	6 RPM 6SEC PR REG	455.20
344BPR-24-03CCS	3RPM 12SEC PR REG	477.15	344BPR-3Q-01D	1RPM 36SEC PR REG	456.23
344BPR-24-03CEC	3RPM 12SEC PR REG	477.15	344BPR-3Q-03COB	3RPM 12SEC PR REG	477.15
344BPR-24-03CFC	3RPM 12SEC PR REG	477.15	344BPR-3Q-03D	3RPM 12SEC PR REG	456.23
344BPR-24-03CFS	3RPM 12SEC PR REG	477.15	344BPR-3Q-06CFC	6 RPM 6SEC PR REG	477.15
344BPR-24-03D	3RPM 12SEC PR REG	455.20	344BPR-3Q-06D	6RPM 6SEC PR REG	455.20
344BPR-24-06C	6RPM 6SEC PR REG	455.20	344BR-23-01C	1RPM 18SEC R REG	473.85
344BPR-24-06CCS	6RPM 6SEC PR REG	477.15	344BR-23-01CCC	1RPM 18SEC R REG	495.81
344BPR-24-06CCU	6RPM 6SEC PR REG	477.15	344BR-23-03C	3RPM 6SEC R REG	473.85
344BPR-2F-01C	1RPM 36SEC PR REG	455.20	344BR-23-03C15FS	3RPM 6SEC R REG	510.23
344BPR-2F-01C03CS	1RPM 36SEC PR REG	477.15	344BR-23-03CUK	3RPM 6SEC R REG	495.81
344BPR-2F-01CEC	1RPM 36SEC PR REG	477.15	344BR-23-06C	6RPM 3SEC R REG	473.85
344BPR-2F-03C	3RPM 12SEC PR REG	455.20	344BR-23-06COB	6RPM 3SEC R REG	495.81
344BPR-2F-03CCC	3RPM 12SEC PR REG	477.15	344BR-23S-03C	3RPM 6SEC R REG SS	557.25
344BPR-2F-03CCS	3RPM 12SEC PR REG	477.15	344BR-23S-06C	6RPM 3SEC R REG SS	568.41
344BPR-2F-03COC	3RPM 12SEC PR REG	477.15	344BR-24-01C	1RPM 18SEC R REG	473.85
344BPR-2F-03CUB	3RPM 12SEC PR REG	477.15	344BR-24-01C60	1RPM 18SEC R REG 6.0M	526.87
344BPR-2F-03CUK	3RPM 12SEC PR REG	477.15	344BR-24-01CCS	1RPM 18SEC R REG	495.81
344BPR-2F-03D	3RPM 12SEC PR REG	455.20	344BR-24-01COB	1RPM 18SEC R REG	495.81
344BPR-2F-06C	6RPM 6SEC PR REG	455.20	344BR-24-01COC	1RPM 18SEC R REG	495.81
344BPR-2F-06CCS	6RPM 6SEC PR REG	477.15	344BR-24-01COU	1RPM 18SEC R REG	495.81
344BPR-2F-06CUK	6RPM 6DEC PR REG	477.15	344BR-24-03C	3RPM 6SEC R REG	473.85
344BPR-2F-06D	6RPM 6SEC PR REG	455.20	344BR-24-03C15	3RPM 6SEC R REG	488.21
344BPR-2Q-03CGC	3RPM 12SEC PR REG	477.15	344BR-24-03CCS	3RPM 6SEC R REG	495.81
344BPR-2Q-03COB	3RPM 12SEC PR REG	477.15	344BR-24-03CEC	3RPM 6SEC R REG	495.81
344BPR-2Q-06C	6RPM 6SEC PR REG	455.20	344BR-24-03CES	3RPM 6SEC R REG	495.81
344BPR-33-01C	1RPM 36SEC PR REG	455.20	344BR-24-03CFS	3RPM 6SEC R REG	495.81
344BPR-33-01D	1RPM 36SEC PR REG	455.20	344BR-24-03COB	3RPM 6SEC R REG	495.81
344BPR-33-03C	3RPM 12SEC PR REG	455.20	344BR-24-06C	6RPM 3SEC R REG	473.85
344BPR-33-03C15	6RPM 6SEC PR REG	469.60	344BR-24-06CCS	6RPM 3SEC R REG	495.81

PART NO.	DESCRIPTION	U.S.DOLLARS	PART NO.	DESCRIPTION	U.S.DOLLARS
344BR-24-06CEC	6RPM 3SEC R REG	495.81	344BR-3F-06CUG	6RPM 3SEC R REG	599.53
344BR-24-06CPG	6RPM 3SEC R REG	495.81	344BR-3FS-03C	3RPM 6SEC R REG SS	672.19
344BR-24-06CUG	6RPM 3SEC R REG	495.81	344BR-3FS-06C	6RPM 3SEC R REG SS	672.19
344BR-24-06CUK	6RPM 3SEC R REG	495.81	344BR-3FS-06C60	6RPM 3SEC R REG SS	773.60
344BR-24S-01C	1RPM 18SEC R REG SS	568.41	344BR-3FS-06CUG	6RPM 3SEC R REG SS	694.18
344BR-24S-01D	1RPM 18SEC R REG SS	568.41	344BR-3Q-03D	3RPM 6SEC R REG	577.63
344BR-24S-03CCC	3RPM 6SEC R REG SS	590.40	344BR-3QS-06C	6RPM 3SEC R REG SS	659.02
344BR-24S-03CCS	3RPM 6SEC R REG SS	590.40	344BR-3QS-06CUG	6RPM 3SEC R REG SS	694.18
344BR-24S-03CES	3RPM 6SEC R REG SS	590.40	344BR-B4-01C	1RPM 18SEC R BYP	493.16
344BR-24S-06C	6RPM 3SEC R REG SS	568.41	344BR-B4-03C15FC	3RPM 6 SEC R BYP	529.46
344BR-24S-06CPG	6RPM 3SEC R REG SS	590.40	344BR-BQ-01D	1RPM 18SEC R REG	493.16
344BR-24S-06CUG	6RPM 3SEC R REG SS	590.40	344BR-BQ-03D	3RPM 6 SEC R BYP	493.16
344BR-24S-06CUK	6RPM 3SEC R REG SS	590.40	344BRL-23-01C	1RPM 18SEC RL REG	473.85
344BR-24S-06D	6RPM 3SEC R REG SS	568.41	344BRL-23-01C60	1RPM 18SEC 3/4 NPT	526.86
344BR-2F-01C	1RPM 18SEC R REG	473.85	344BRL-23-01CCC	1RPM 18SEC RL REG	495.81
344BR-2F-01COC	1RPM 18SEC R REG	495.81	344BRL-23-01CCS	1RPM 18SEC RL REG	495.81
344BR-2F-01D	1RPM 18SEC R REG	473.85	344BRL-23-01CEC	1RPM 18SEC RL REG	495.81
344BR-2F-03C	3RPM 6SEC R REG	473.85	344BRL-23-01D	1RPM 18SEC RL REG	473.85
344BR-2F-03CCS	3RPM 6 SEC R REG	495.81	344BRL-23-03C	3RPM 6SEC RL REG	473.85
344BR-2F-03CEC	3RPM 6SEC R REG	495.81	344BRL-23-03C15CS	3RPM 6SEC RL REG	510.22
344BR-2F-03CES	3RPM 6SEC R REG	495.81	344BRL-23-03CCC	3RPM 6SEC RL REG	495.81
344BR-2F-03CUK	3RPM 6SEC R REG	495.81	344BRL-23-03CCS	3RPM 6SEC RL REG	495.81
344BR-2F-03D	3RPM 6SEC R REG	473.85	344BRL-23-03CEC	3RPM 6SEC RL REG	495.81
344BR-2F-06C	6RPM 3SEC R REG	473.85	344BRL-23-06C	6RPM 3SEC RL REG	473.85
344BR-2F-06C15QB	6RPM 3SEC R REG	510.23	344BRL-23-06C15	6RPM 3SEC RL REG	488.21
344BR-2F-06C60EC	6RPM 3SEC R REG	548.88	344BRL-23-06C15EC	6RPM 3SEC RL REG	510.22
344BR-2F-06CEC	6RPM 3SEC R REG	495.81	344BRL-23-06CCS	6RPM 3SEC RL REG	495.81
344BR-2F-06D	6RPM 3SEC R REG	473.85	344BRL-23-06CEC	6RPM 3SEC RL REG	495.81
344BR-2FS-01C	1RPM 18SEC R REG SS	568.41	344BRL-23-06CUG	6RPM 3SEC RL REG	495.81
344BR-2FS-03C	3RPM 6SEC R REG SS	568.41	344BRL-23S-01C	1RPM 18SEC RL REG SS	568.67
344BR-2FS-03CCS	3RPM 6SEC R REG SS	590.40	344BRL-23S-01CCC	1RPM 18SEC RL REG SS	590.40
344BR-2FS-03D	3RPM 6SEC R REG SS	568.41	344BRL-23S-01CFC	1RPM 18SEC RL REG SS	590.40
344BR-2FS-06D	6RPM 3SEC R REG SS	568.41	344BRL-23S-03C	3RPM 6SEC RL REG SS	568.41
344BR-2Q-01C15	1RPM 18SEC R REG	488.21	344BRL-23S-03C03	3RPM 6SEC RL REG SS	568.41
344BR-2Q-01D	1 RPM 18SEC R REG	460.04	344BRL-23S-03CGS	3RPM 6SEC RL REG SS	590.40
344BR-33-01C	1 RPM 18 SEC R REG	577.63	344BRL-23S-06C	6RPM 3SEC RL REG SS	568.41
344BR-33-03C	3RPM 6SEC R REG	577.63	344BRL-23S-06C15	6RPM 3SEC RL REG SS	582.79
344BR-33-06C	6RPM 3 SEC R REG	577.63	344BRL-23S-06C60	6RPM 3SEC RL REG SS	621.46
344BR-33-06CUG	6RPM 3 SEC R REG	599.53	344BRL-23S-06CGS	6RPM 3SEC RL REG SS	590.40
344BR-33S-01C	1RPM 18SEC R REG SS	672.19	344BRL-24-01C	1RPM 18SEC RL REG	473.85
344BR-33S-03C	3RPM 6SEC R REG SS	672.19	344BRL-24-01C03	1RPM 18SEC RL REG	473.85
344BR-33S-06C	6RPM 3SEC R REG SS	672.19	344BRL-24-01C60CS	1RPM 18SEC RL REG	548.85
344BR-33S-06CA	6RPM 3SEC R REG SS	683.25	344BRL-24-01CCC	1RPM 18SEC RL REG	495.81
344BR-33S-06D	6 RPM 3SEC R REG SS	568.41	344BRL-24-01CCS	1RPM 18SEC RL REG	495.81
344BR-34-01C	1RPM 18SEC R REG	577.63	344BRL-24-01CES	1RPM 18SEC RL REG	495.81
344BR-34-03C	3RPM 6 SEC R REG	577.63	344BRL-24-01CFC	1RPM 18SEC RL REG	495.81
344BR-34-03CCS	3RPM 6 SEC R REG	599.53	344BRL-24-01COB	1RPM 18SEC RL REG	495.81
344BR-34-03CEC	3RPM 6 SEC R REG	599.53	344BRL-24-01COC	1RPM 18SEC RL REG	495.81
344BR-34-06C	6RPM 3SEC R REG	577.63	344BRL-24-01D	1RPM 18SEC RL REG	473.85
344BR-34-06CUG	6RPM 3SEC R REG	599.53	344BRL-24-03C	3RPM 6SEC RL REG	473.85
344BR-34-06CUK	6RPM 3SEC R REG	599.53	344BRL-24-03C03CC	3RPM 6SEC RL REG	495.81
344BR-34S-03C	3RPM 6SEC R REG SS	672.19	344BRL-24-03C03GS	3RPM 6SEC RL REG	495.81
344BR-34S-03CCC	3RPM 6SEC R REG SS	694.19	344BRL-24-03C15	3RPM 6SEC RL REG	488.21
344BR-34S-03CCS	3RPM 6SEC R REG SS	694.19	344BRL-24-03CCC	3RPM 6SEC RL REG	495.81
344BR-34S-03CUG	3RPM 6SEC R REG SS	694.19	344BRL-24-03CCS	3RPM 6SEC RL REG	495.81
344BR-34S-06C	6RPM 3SEC R REG SS	665.53	344BRL-24-03CDC	3RPM 6SEC RL REG	495.81
344BR-34S-06CCS	6RPM 3SEC R REG SS	713.21	344BRL-24-03CEC	3RPM 6SEC RL REG	495.81
344BR-34S-06CUG	6RPM 3SEC R REG SS	694.19	344BRL-24-03D	3 RPM 6 SEC RL REG	473.85
344BR-34S-06CUK	6RPM 3SEC R REG SS	694.19	344BRL-24-06C	6RPM 3SEC RL REG	473.85
344BR-3F-01C	3RPM 6SEC R REG	577.63	344BRL-24-06CCS	6RPM 3 SEC RL REG	495.81
344BR-3F-03C	3RPM 6SEC R REG	577.63	344BRL-24-06CUG	6RPM 3SEC RL REG	495.81
344BR-3F-03C15	3RPM 6SEC R REG	592.04	344BRL-24S-01C	1RPM 18SEC RL REG SS	568.67
344BR-3F-03D	3RPM 6SEC R REG	577.63	344BRL-24S-01CCC	1RPM 18SEC RL REG SS	590.40
344BR-3F-06C	6RPM 3SEC R REG	577.63	344BRL-24S-01CES	1RPM 18SEC RL REG SS	590.40

PART NO.	DESCRIPTION	U.S.DOLLARS	PART NO.	DESCRIPTION	U.S.DOLLARS
344BRL-24S-03C	3RPM 6SEC RL REG SS	568.41	344BRL-BQS-03C	3RPM 6SEC RL BYP SS BALL	588.08
344BRL-24S-03C60	3RPM 6SEC RL REG SS	621.46	344BRL-BQS-03C15	3RPM 6SEC RL BYP SS BALL	602.45
344BRL-24S-03C60IK	3RPM 6SEC RL REG SS	643.44	344BRL-BQS-03CCS	3RPM 6SEC RL BYP SS BALL	610.10
344BRL-24S-03CCC	3RPM 6SEC RL REG SS	590.40	344BRL-TH-01CCCC	1RPM 18SEC RL THR	495.81
344BRL-24S-03CCS	3RPM 6SEC RL REG SS	590.40	344BRL-TH-01CCS	1RPM 18SEC RL THR	495.81
344BRL-24S-03CFS	3RPM 6SEC RL REG SS	590.40	344BRL-TH-01CGC	1RPM 18SEC RL THR	495.81
344BRL-24S-03CGS	3RPM 6SEC RL REG SS	590.40	344BRL-TH-01D	1RPM 18SEC RL THR	473.85
344BRL-24S-06C15	6RPM 3SEC RL REG SS	582.79	344BRL-TH-03C	3RPM 6SEC RL THR	473.85
344BRL-24S-06CCC	6 RPM 3 SEC RL REG	590.40	344BRL-TH-03CCC	3RPM 6SEC RL THR	495.81
344BRL-24S-06CCS	6SEC RL REG SS	590.40	344BRL-TH-03CCS	3RPM 6SEC RL THR	495.81
344BRL-24S-06CUX	6RPM 3SEC RL REG	590.40	344BRL-TH-03D	3RPM 6SEC RL THR	473.85
344BRL-2F-01C	1RPM 18SEC RL REG	473.85	344BRL-TH-03P	3RPM 6SEC RL THR LESS CABLE	452.45
344BRL-2F-01C60	1RPM 18SEC RL REG	526.86	346BE-25-C	SHUT OFF VALVE 1-1/4	859.91
344BRL-2F-01CCC	1RPM 18SEC RL REG	495.81	346BE-25-C15	SHUT OFF VALVE 1-1/4	874.30
344BRL-2F-01CCS	1RPM 18SEC RL REG	495.81	346BE-26-C	SHUTOFF VALVE 1-1/2	859.91
344BRL-2F-01CEC	1RPM 18SEC RL REG	495.81	346BE-26-COC	SHUTOFF VALVE 1-1/2	881.84
344BRL-2F-01CUK	1RPM 18SEC RL REG	495.81	346BE-26-D	SHUTOFF VALVE 1-1/2	859.91
344BRL-2F-01CVX	1RPM 18SEC RL REG	495.81	346BE-2F75-D	SHUTOFF/BYPASS	859.91
344BRL-2F-01D	1RPM 18SEC RL REG	473.85	346BE-2F75-P	SHUTOFF VALVE 75F LESS CABLE	838.52
344BRL-2F-03C	3RPM 6SEC RL REG	473.85	346BE-2M-C	430 MASTER SHUTOFF	1013.83
344BRL-2F-03C03GS	3RPM 6SEC RL REG	495.81	346BE-2M-D	430 MASTER SHUTOFF	1013.83
344BRL-2F-03C60IG	3RPM 6SEC RL REG	548.88	346BE-35-C	SHUTOFF/BYPASS 1-1/4	859.91
344BRL-2F-03CCS	3RPM 6SEC RL REG	495.81	346BE-36-C	SHUTOFF/BYPASS 1-1/2	859.91
344BRL-2F-03CEC	3RPM 6SEC RL REG	495.81	346BE-36-C60	SHUTOFF/BYPASS 1-1/2	912.97
344BRL-2F-03CFC	3RPM 6SEC RL REG	495.81	346BE-36-D	SHUTOFF/BYPASS 1-1/2	859.91
344BRL-2F-03CGC	3RPM 6SEC RL REG	495.81	346BE-3F75-D	SHUTOFF/BYPASS	859.91
344BRL-2F-03CPU	3RPM 6SEC RL REG	495.81	346BEC-25-C	SHUTOFF VALVE 1-1/4	859.91
344BRL-2F-03CUG	3RPM 6SEC RL REG	495.81	346BEC-25-C03	SHUTOFF VALVE 1-1/4	859.91
344BRL-2F-03CUK	3RPM 6SEC RL REG	495.81	346BEC-25-C03OG	SHUTOFF VALVE 1-1/4	881.84
344BRL-2F-03D	3RPM 6SEC RL REG	473.85	346BEC-25-C15	SHUTOFF VALVE 1-1/4	874.32
344BRL-2F-06C	6RPM 3SEC RL REG	473.85	346BEC-25-C60	SHUTOFF VALVE 1-1/4	912.97
344BRL-2F-06CFC	6RPM 3SEC RL REG	495.81	346BEC-25-COC	SHUTOFF VALVE 1-1/4	881.84
344BRL-2F-06CHC	6RPM 3SEC RL REG	495.81	346BEC-25-CPB	SHUTOFF VALVE 1-1/4	881.84
344BRL-2F-06CUG	6RPM 3SEC RL REG	495.81	346BEC-25-CPC	SHUTOFF VALVE 1-1/4	873.11
344BRL-2F-06CUK	6RPM 3SEC RL REG	495.81	346BEC-25-CUG	SHUTOFF VALVE 1-1/4	881.84
344BRL-2F-06D	6 RPM 3SEC RL REG	473.85	346BEC-25-D	SHUT-OFF VALVE 1-1/4	859.91
344BRL-2FS-01C	1RPM 18SEC RL REG SS	568.41	346BEC-25-P	SHUTOFF VALVE 1-1/4 LESS CABLE	838.52
344BRL-2FS-03C	3RPM 6SEC RL REG SS	568.41	346BEC-25S-C	SHUTOFF VALVE 1-1/4-SS	1016.22
344BRL-2FS-03C60IG	3RPM 6SEC RL REG SS	643.44	346BEC-25S-C15	SHUTOFF VALVE 1-1/4 SS	1030.62
344BRL-2FS-03CCD	3RPM 6SEC RL REG SS	590.40	346BEC-25S-CVX	SHUTOFF VALVE SS 1-1/4	1038.16
344BRL-2FS-03CCS	3RPM 6SEC RL REG SS	590.40	346BEC-26-C	SHUTOFF VALVE 1-1/2	859.91
344BRL-2FS-03D	3RPM 6SEC RL REG SS	568.41	346BEC-26-C03	SHUTOFF VALVE 1-1/2	859.91
344BRL-2Q-03C	3RPM 6SEC RL REG	473.85	346BEC-26-C03OG	SHUTOFF VALVE 1-1/2	881.84
344BRL-2Q-03D	3RPM 6SEC RL REG	473.85	346BEC-26-C15	SHUTOFF VALVE 1-1/2	874.30
344BRL-2QS-03CCC	3RPM 6SEC RL REG SS	590.40	346BEC-26-C60	SHUTOFF VALVE 1-1/2	912.97
344BRL-2QS-06CFC	6RPM 3SEC RL REG SS	590.40	346BEC-26-COC	SHUTOFF VALVE 1-1/2	881.84
344BRL-B3-03CCS	3RPM 6SEC RL BYP	515.16	346BEC-26-CPB	SHUTOFF VALVE 1-1/2	881.84
344BRL-B3-03D	3RPM 6SEC RP BYP	493.16	346BEC-26-CPC	SHUTOFF VALVE 1-1/2	881.84
344BRL-BF-03C	3RPM 6SEC RL BYP F50	493.16	346BEC-26-CUX	SHUTOFF VALVE 1-1/2	881.84
344BRL-BF-03D	3RPM 6SEC RL BYP F50	493.16	346BEC-26-CVX	SHUTOFF VALVE 1-1/2	881.84
344BRL-BQ-01C	1RPM 18SEC RL BYP	493.16	346BEC-26-D	SHUTOFF VALVE 1-1/2	859.91
344BRL-BQ-01C03EC	1RPM 18SEC RL BYP	515.16	346BEC-26S-C	SHUTOFF VALVE1-1/2SS	1016.22
344BRL-BQ-01CCC	1RPM 18SEC RL BYP	515.16	346BEC-26S-C03	SHUTOFF VALVE1-1/2SS	1016.22
344BRL-BQ-01CCS	1RPM 18SEC RL BYP	515.16	346BEC-26S-C15	SHUTOFF VALVE1-1/2SS	1030.60
344BRL-BQ-01D	1RPM 18SEC RL BYP	493.16	346BEC-26S-C60	SHUTOFF VALVE1-1/2SS	1069.27
344BRL-BQ-01P	1RPM 18SEC RL BYP - LESS CABLE	471.75	346BEC-26S-CJ	SHUTOFF VALVE1-1/2SS	870.84
344BRL-BQ-03C	3RPM 6SEC RL BYP	493.16	346BEC-26S-CN15	SHUTOFF VALVE 1-1/2SS	1030.60
344BRL-BQ-03CCS	3RPM 6SEC RL BYP	515.16	346BEC-26S-CVX	SHUTOFF VALVE SS 1-1/2	1017.79
344BRL-BQ-03CEC	3RPM 6SEC RL BYP	515.16	346BEC-26S-P	SHUTOFF VALVE1-1/2SS LESS CABLE	994.81
344BRL-BQ-03CGC	3RPM 6SEC RL BYP	515.16	346BEC-2F-C	SHUTOFF VALVE 50F	859.91
344BRL-BQ-03D	3RPM 6SEC RL BYP	493.16	346BEC-2F-C15	SHUTOFF VALVE FLANGE	874.30
344BRL-BQ-03P	3RPM 6SEC RL BYP - LESS CABLE	471.75	346BEC-2F-COC	SHUTOFF VALVE FLANGE	881.84
344BRL-BQ-06D	6 RPM 3 SEC RL BYP	493.16			
344BRL-BQS-01D	1RPM 18SEC RL BYP SS BALL	588.08			

PART NO.	DESCRIPTION	U.S.DOLLARS	PART NO.	DESCRIPTION	U.S.DOLLARS
346BEC-2F-CVX	SHUTOFF VALVE FLANGE	881.84	346BPR-2F75-03C60	3 RPM 12SEC REG 75F	1044.92
346BEC-2F-D	SHUTOFF VALVE FLANGE	859.91	346BPR-2F75-03CCS	3RPM 12SEC REG 75F	1013.83
346BEC-2F75-C	SHUTOFF VALVE 75F	859.91	346BPR-2F75-03CES	3RPM 12SEC REG 75F	1013.83
346BEC-2F75-C15	SHUTOFF VALVE 75F	874.30	346BPR-2F75-03CGC	3 RPM 12SEC REG 75F	1013.83
346BEC-2F75-CVX	SHUTOFF VALVE 75F	881.84	346BPR-2F75-03CHC	3RPM 12SEC REG 75F	1013.83
346BEC-2F75-D	SHUTOFF VALVE 75F	859.91	346BPR-2F75-03D	3RPM 12SEC REG 75F	991.88
346BEC-2F75-DN	SHUTOFF VALVE 75F, NEG	859.91	346BPR-2F75-06C	6RPM 6SEC REG 75F	991.88
346BEC-2F75S-C	SHUT-OFF VALVE 75F	1016.22	346BPR-2F75-06CCS	6RPM 6SEC REG 75F	1014.63
346BEC-2F75S-CQC	SHUT-OFF VALVE 75F	1038.21	346BPR-2F75-06CGS	6RPM 6SEC REG 75F	1123.93
346BEC-2FS-C	SHUTOFF VALVE 50F	1016.75	346BPR-2F75-06CHC	6RPM 6SEC REG 75F	1013.83
346BEC-2FS-CPU	SHUTOFF VALVE 50F	1038.21	346BPR-2F75-06D	6RPM 6SEC REG 75F	991.88
346BEC-2FS-D	SHUTOFF VALVE F	1016.22	346BPR-2F75S-03C	3 RPM 12 SEC F75 SS	1128.52
346BEC-2M-C	430 MASTER SHUTOFF M50	1013.83	346BPR-2F75S-06CGC	6 RPM 6 SEC F75 SS	1158.58
346BEC-2M-D	430 MASTER SHUTOFF M50	1013.83	346BPR-35-01C	1RPM 36SEC PR REG	991.88
346BEC-35-C	SHUTOFF/BYPASS 1-1/4	859.91	346BPR-35-03C	3RPM 12SEC REG 1-1/4	991.88
346BEC-35-C03OG	SHUTOFF/BYPASS 1-1/4	881.84	346BPR-35-03CCD	3RPM 12SEC REG 1-1/4	1013.83
346BEC-35-C15	SHUTOFF/BYPASS 1-1/4	874.32	346BPR-35-06C	6RPM 6SEC REG 1-1/4	991.88
346BEC-35-CJ	SHUTOFF 1-1/4 VALVE	870.87	346BPR-35-06CCS	6RPM 6SEC REG 1-1/4	1013.83
346BEC-35-COG	SHUTOFF/BYPASS 1-1/4	881.84	346BPR-35-06COC	6RPM 6SEC REG 1-1/4	1013.83
346BEC-35-CVX	SHUTOFF/BYPASS 1-1/4	881.84	346BPR-35-06CUG	6RPM 6SEC REG 1-1/4	1013.83
346BEC-35-D	SHUTOFF/BYPASS 1-1/4	859.91	346BPR-35-06CUK	6RPM 6SEC REG 1-1/4	1013.83
346BEC-35-DN	SHUTOFF/BYPASS NEG 1-1/4	859.91	346BPR-36-01C	1RPM 36Sec PR REG	991.88
346BEC-36-C	SHUTOFF/BYPASS 1-1/2	859.91	346BPR-36-03C	3RPM 12SEC REG 1-1/2	991.88
346BEC-36-C15	SHUTOFF/BYPASS 1-1/2	874.32	346BPR-36-03CCS	3RPM 12SEC REG 1-1/2	1013.83
346BEC-36-C60	SHUTOFF/BYPASS 1-1/2	912.97	346BPR-36-03CFC	6RPM 6SEC REG 1-1/2	1013.83
346BEC-36-CK	SHUTOFF/BYPASS 1-1/2	870.97	346BPR-36-03D	3RPM 12SEC PR REG 1-1/2	991.88
346BEC-36-CPS	SHUTOFF/BYPASS 3-WAY VALVE	846.58	346BPR-36-06C	6RPM 6SEC REG 1-1/2	991.88
346BEC-36-CVX	SHUTOFF/BYPASS 1-1/2	881.84	346BPR-36-06CCS	6RPM 6SEC REG 1-1/2	1013.83
346BEC-36-D	SHUTOFF/BYPASS 1-1/2	859.91	346BPR-36-06COC	6RPM 6SEC REG 1-1/2	1013.83
346BEC-3F-C	SHUTOFF/BYPASS 50F	859.91	346BPR-36-06CUG	6RPM 6SEC REG 1-1/2	1013.83
346BEC-3F-CK	SHUTOFF/BYPASS 1-1/4	859.91	346BPR-36-06CUK	6RPM 6SEC REG 1-1/2	1013.83
346BEC-3F-COB	SHUTOFF/BYPASS 50F	881.84	346BPR-36-06D	6RPM 6SEC REG 1-1/2	991.88
346BEC-3F-CVS	SHUTOFF/BYPASS 50F	881.90	346BPR-36S-03CJ	3RPM 12SEC PR REG SS 1-1/2	1139.44
346BEC-3F-CVX	SHUTOFF/BYPASS F	881.90	346BPR-3F-01C	1RPM 36SEC REG 50F	991.88
346BEC-3F-D	SHUTOFF/BYPASS 50F	859.91	346BPR-3F-03C	3RPM 12SEC PR REG 50F	991.88
346BEC-3F75-C	SHUTOFF-BYPASS 75F	859.91	346BPR-3F-03C15	3RPM 12SEC REG 50F	1006.26
346BEC-3F75-C15TU	SHUTOFF-BYPASS 75F	896.25	346BPR-3F-03CGC	3RPM 12SEC PR REG 50F	1013.83
346BEC-3F75-CPG	SHUTOFF / BYPASS 75F	881.90	346BPR-3F-03COB	3RPM 12SEC REG 50F	1013.83
346BEC-3F75-CPK	SHUTOFF-BYPASS 75F	881.90	346BPR-3F-03CUK	3BPR 12SEC REG 50F	1013.83
346BEC-3F75-CQB	SHUTOFF/BYPASS 75F	881.90	346BPR-3F-03D	3RPM 12SEC REG 50F	991.88
346BEC-3F75-CQC	SHUTOFF/ BYPASS 75F	881.90	346BPR-3F-06C	6RPM 6SEC REG 50F	991.88
346BEC-3F75-CVX	SHUTOFF-BYPASS 75F	881.90	346BPR-3F-06C03CC	6RPM 6SEC REG 50F	1013.83
346BEC-3F75-D	SHUTOFF-BYPASS 75F	859.91	346BPR-3F-06CGC	6RPM 6SEC REG 50F	1013.83
346BEC-3F75-DN	SHUTOFF-BYPASS 75F	859.91	346BPR-3F-06CUK	6RPM 6SEC REG 50F	1013.83
346BPR-25-01C	1RPM 36SEC REG 1-1/4	991.88	346BPR-3F-06D	6RPM 6SEC REG 50F	991.88
346BPR-25-03CES	3RPM 12SEC REG 1-1/4	1013.83	346BPR-3F75-01CCS	1PRM 36SEC REG 75F	1013.83
346BPR-25-06C	6RPM 6SEC REG 1-1/4	991.88	346BPR-3F75-03C60	3RPM 12SEC REG 75	1044.92
346BPR-25-06CCS	6RPM 6SEC REG 1-1/4	1013.83	346BPR-3F75-03CCS	3RPM 12SEC REG 75F	1013.83
346BPR-26-01C	1RPM 36SEC REG 1-1/2	991.88	346BPR-3F75-03D	3RPM 12SEC REG 75F	991.88
346BPR-26-03C	3RPM 12SEC REG 1-1/2	991.88	346BPR-3F75-06C	6RPM 6SEC REG 75F	991.88
346BPR-26-03CCC	3RPM 12SEC REG 1-1/2	1013.83	346BPR-3F75-06C60	6RPM 6SEC REG 75F	1044.92
346BPR-26-06C	6RPM 6SEC REG 1-1/2	991.88	346BPR-3F75-06CCS	3RPM 6SEC REG 75F	1013.83
346BPR-26-06CCC	6RPM 6SEC REG 1-1/2	1013.83	346BPR-3F75-06D	3RPM 6SEC REG 75F	991.88
346BPR-26-06CCS	6RPM 6SEC REG 1-1/2	1013.83	346BR-25-01C	1RPM 18SEC REG 1-1/4	991.88
346BPR-2F-01C	1RPM 36SEC 50F	991.88	346BR-25-01C03EC	1RPM 18SEC REG 1-1/4	1013.83
346BPR-2F-01CCS	1RPM 36SEC 50F	1013.83	346BR-25-03C	3RPM 6SEC REG 1-1/4	991.88
346BPR-2F-03C	3RPM 12SEC REG 50F	991.88	346BR-25-03C60CS	3RPM 6SEC REG 1-1/4	1066.88
346BPR-2F-03COC	3RPM 12SEC REG 50F	1013.83	346BR-25-03CA	3RPM 6SEC REG 1-1/4	1003.01
346BPR-2F-06C	6RPM 6SEC REG 50F	991.88	346BR-25-03CCS	3RPM 6SEC REG 1-1/4	1013.83
346BPR-2F-06C03	6RPM 6SEC REG 50F	991.88	346BR-25-03D	3RPM 6SEC REG 1-1/4	991.88
346BPR-2F-06CCS	6RPM 6SEC REG 50F	1013.83	346BR-25-06C	6RPM 3SEC REG 1-1/4	991.88
346BPR-2F-06CUG	6RPM 6SEC REG 50F	1013.83	346BR-25-06CCS	6RPM 3SEC REG 1-1/4	1013.83
346BPR-2F-06D	6RPM 6SEC REG 50F	991.88	346BR-25S-01C	1RPM 18SEC REG 1-1/4	1148.16
346BPR-2F75-03C	3RPM 12SEC REG 75F	991.88	346BR-25S-03C	3 RPM 6SEC REG 1-1/4	1148.16

PART NO.	DESCRIPTION	U.S.DOLLARS	PART NO.	DESCRIPTION	U.S.DOLLARS
346BR-25S-03C60IG	3RPM 6SEC REG 1-1/4	1223.21	346BR-2FS-06C	6RPM 3SEC REG 50F	1148.16
346BR-25S-03CA	3RPM 6SEC REG 1-1/4	1159.30	346BR-2FS-06D	6RPM 3SEC REG 50F	1148.16
346BR-25S-03CCS	3RPM 6SEC REG 1-1/4	1170.17	346BR-35-01C	3RPM 6SEC REG 1-1/4	991.88
346BR-26-01C	1RPM 18SEC REG 1-1/2	991.88	346BR-35-03C	3RPM 6SEC REG 1-1/4	991.88
346BR-26-01C03EC	18 SEC REG 1-1/2	1013.83	346BR-35-03CCS	3RPM 6SEC REG 1-1/4	1013.83
346BR-26-01CCC	1RPM 6SEC REG 1-1/2	1013.83	346BR-35-06C	6RPM 3SEC REG 1-1/4	991.88
346BR-26-01CCS	1RPM 6SEC REG 1-1/2	1013.83	346BR-35-06CCS	6RPM 3SEC REG 1-1/4	1013.83
346BR-26-01D	1RPM 18SEC REG 1-1/2	991.88	346BR-35-06CUG	6RPM 3SEC REG 1-1/4	1013.83
346BR-26-03C	3RPM 6SEC REG 1-1/2	991.88	346BR-36-01C	1RPM 18SEC REG 1-1/2	991.88
346BR-26-03CCC	3RPM 6SEC REG 1-1/2	1013.83	346BR-36-03C	3RPM 6SEC REG 1-1/2	991.88
346BR-26-03CCS	3RPM 6SEC REG 1-1/2	1013.83	346BR-36-03C60	3RPM 6SEC REG 1-1/2	1044.94
346BR-26-03D	3RPM 6SEC REG 1-1/2	991.88	346BR-36-03CCS	6RPM 3SEC REG 1-1/2	1013.83
346BR-26-06C	6RPM 3SEC REG 1-1/2	991.88	346BR-36-03COB	6RPM 3SEC REG 1-1/2	1013.83
346BR-26-06CCC	6RPM 3SEC REG 1-1/2	1013.83	346BR-36-06C	6RPM 3SEC REG 1-1/2	991.88
346BR-26-06CUG	6RPM 3SEC REG 1-1/2	1013.83	346BR-36-06CUG	6RPM 3SEC REG 1-1/2	1013.83
346BR-26-06CUK	6RPM 3SEC REG 1-1/2	1013.83	346BR-3F-01C	1RPM 18SEC REG 50F	991.88
346BR-26-06CUQ	6RPM 3SEC REG 1-1/2	1013.83	346BR-3F-03C	3RPM 6SEC REG 50F	991.88
346BR-26S-03C	3RPM 6SEC REG 1-1/2 SS	1148.16	346BR-3F-03D	3RPM 6SEC REG 50F	991.88
346BR-26S-03C15	3RPM 6SEC REG 1-1/2 SS	1006.27	346BR-3F-06C	6RPM 3SEC REG 50F	991.88
346BR-26S-03C15CS	3RPM 6SEC REG 1-1/2 SS	1183.66	346BR-3F75-01C	1RPM 18SEC REG 75F	991.88
346BR-26S-03C60	3RPM 6SEC REG 1-1/2 SS	1202.11	346BR-3F75-01D	3RPM 6SEC REG 75F	991.88
346BR-26S-03CCS	3RPM 6SEC REG 1-1/2 SS	1170.17	346BR-3F75-03C	3RPM 6SEC REG 75F	991.88
346BR-26S-03CEC	3RPM 6SEC REG 1-1/2 SS	1170.17	346BR-3F75-03C60	SHUTOFF-BYPASS 75F	912.97
346BR-26S-03D	3RPM 6SEC REG 1-1/2 SS	1148.16	346BR-3F75-03CCS	3RPM 6SEC REG 75F	1013.89
346BR-26S-06C	6RPM 3SEC REG 1-1/2 SS	1148.16	346BR-3F75-03CEC	3RPM 6SEC REG 75F	1013.89
346BR-26S-06C15CS	6RPM 3SEC REG 75F SS	1183.66	346BR-3F75-03COB	3RPM 6SEC REG 75F	1013.89
346BR-2F-01C	1RPM 18SEC REG 50F	991.88	346BR-3F75-03CUG	3RPM 6SEC REG 75F	994.00
346BR-2F-01C15	1RPM 18SEC REG 50F	1006.26	346BR-3F75-03D	3RPM 6SEC REG 75F	991.88
346BR-2F-01CCS	1RPM 18SEC REG 50F	1013.83	346BR-3F75-06C	6RPM 3SEC REG 75F	991.88
346BR-2F-03C	3RPM 6SEC REG 50F	991.88	356BE-C	356 TRUNNION VALVE	619.89
346BR-2F-03C60IG	3RPM 6SEC REG 50F	1066.88	356BE-CPB	356 TRUNNION VALVE	641.78
346BR-2F-03CCC	3RPM 6SEC REG 50F	1013.83	356BE-D	356 TRUNNION VALVE	619.89
346BR-2F-03CCS	3RPM 6SEC REG 50F	1013.83	356BEC-C	356 TRUNNION VALVE	619.89
346BR-2F-03CUG	3RPM 6SEC REG 50F	1013.83	356BEC-C03	356 TRUNNION VALVE	619.89
346BR-2F-03D	3RPM 6SEC REG 50F	991.88	356BEC-C03PG	356 TRUNNION VALVE	641.78
346BR-2F-06C	6RPM 3SEC REG 50F	991.88	356BEC-C15	356 TRUNNION VALVE	634.27
346BR-2F-06CCC	6RPM 3SEC REG 50F	1013.83	356BEC-C15PU	356 TRUNNION VALVE	656.16
346BR-2F75-01C	1RPM 18SEC REG 75F	991.88	356BEC-C60	356 TRUNNION VALVE	672.93
346BR-2F75-01CCS	1RPM 18 SEC REG 75F	1013.83	356BEC-C60OC	356 TRUNNION VALVE	694.83
346BR-2F75-01D	1RPM 18SEC REG 75F	991.88	356BEC-C60VX	356 TRUNNION VALVE	694.83
346BR-2F75-03C	3RPM 6SEC REG 75F	991.88	356BEC-CN	356 TRUNNION VALVE	619.89
346BR-2F75-03C30UK	3RPM 6SEC REG 75F	1027.19	356BEC-COC	356 TRUNNION VALVE	641.78
346BR-2F75-03C60	3RPM 6SEC REG 75F	1044.92	356BEC-CPB	356 TUNNION VALVE	641.78
346BR-2F75-03CCC	3RPM 6SEC REG 75F	1013.83	356BEC-CPC	356 TRUNNION VALVE	641.78
346BR-2F75-03CCS	3RPM 6SEC REG 75F	1013.83	356BEC-CPG	356 TRUNNION VALVE	641.78
346BR-2F75-03CEC	3RPM 6SEC REG 75F	1013.83	356BEC-CPU	356 TRUNNION VALVE	641.78
346BR-2F75-03D	3RPM 6SEC REG 75F	991.88	356BEC-CSC	356 TRUNNION VALVE	641.78
346BR-2F75-06C	6RPM 3SEC REG 75F	991.88	356BEC-CTB	356 TRUNNION VALVE	641.78
346BR-2F75-06CUG	6RPM 3SEC REG 75F	1013.83	356BEC-CUW	356 TRUNNION VALVE	641.78
346BR-2F75-06D	6RPM 3SEC REG 75F	991.88	356BEC-CVV	356 TRUNNION VALVE	641.78
346BR-2F75S-01D	1RPM 18SEC REG 75F SS	1148.16	356BEC-CVX	356 TRUNNION VALVE	641.78
346BR-2F75S-03C	3RPM 6SEC REG 75F SS	1148.16	356BEC-CWX	356 TRUNNION VALVE	641.78
346BR-2F75S-03C60	3RPM 6SEC REG 75F SS	1202.11	356BEC-D	356 TRUNNION VALVE	619.89
346BR-2F75S-03CCS	3RPM 6SEC REG 75F SS	1169.29	356BEC-DN	356 TRUNNION VALVE	619.89
346BR-2F75S-03CEC	3RPM 6SEC REG 75F SS	1169.29	356BEC-P	356 TRUNNION VALVE LESS CABLE	598.49
346BR-2F75S-03CES	3RPM 6SEC REG 75F SS	1169.29	356BR-03C	3RPM 6SEC R REG VALV	660.91
346BR-2F75S-03CFC	3RPM 6SEC REG 75F SS	1169.29	36275-1/2X1/2	ADJ JOINT, BRASS	174.09
346BR-2F75S-03CGC	3RPM 6SEC REG 75F SS	1169.29	36275-1/4x1/4	1/4MX1/4F ADJ JOINT, BRASS	80.70
346BR-2F75S-03D	3RPM 6SEC REG 75F SS	1148.16	36275-1/4X1/4-SS	ADJ JOINT, ST.STL.	147.15
346BR-2F75S-06C15CS	6RPM 3SEC REG 75F SS	1183.66	36314-PP-2-100-SS	STRAINER ASB W/CV	6.73
346BR-2F75S-06CGC	6RPM 3SEC REG 75F SS	1169.29	364BEC-23-C	SHUTOFF VALVE W/ MNTG FT 3/4"	461.07
346BR-2FS-03C	3RPM 6SEC REG 50F	1148.16	364BEC-2F-P	SHUTOFF VALVE W/MNTG FT F50	461.07
346BR-2FS-03C60IG	3RPM 6SEC REG 50F	1223.21			
346BR-2FS-03D	3RPM 6SEC REG 50F	1148.16			

PART NO.	DESCRIPTION	U.S.DOLLARS	PART NO.	DESCRIPTION	U.S.DOLLARS
364BPR-3F-03D	3RPM 12SEC PR REG VALVE W/ MNTG FT F50	455.20	38615A-3-540-NYB	QT HOSESHK,TRIPLE LP	32.02
364BR-2LQ-06D	6RPM 3SEC R REG VALVE W/ MNTG FT LQC	473.85	38615A-3-785-NYB	QT HOSESHK,TRIPLE LP	32.02
36541-1-NYR	QT CAP/GASKET / BLACK	1.79	38616-311-375-NYB	VARI-QUICK S/ASB.LP	12.33
36541-3-NYR	QT CAP/GASKET / RED	1.79	38616-311-375-PP	VARI-QUICK S/ASB.LP	15.14
36541-4-NYR	QT CAP/GASKET/BLUE	1.79	38616-311-500-NYB	VARI-QUICK S/ASB.LP	12.33
36541-5-NYR	QT CAP/GASKET/GREEN	1.79	38616-311-500-PP	VARI-QUICK S/ASB.LP	15.14
36541-6-NYR	QT CAP/GASKET/YELLOW	1.79	38616-311-750-NYB	VARI-QUICK S/ASB.LP	12.33
36541-9-NYR	QT CAP/GASKET / GREY	1.79	38616-311-750-PP	VARI-QUICK S/ASB.LP	15.14
366BEC-25-C	SHUTOFF VALVE W/ MNTG FT 1-1/4"	859.91	38617-312-375-NYB	VARI-QUICK S/ASB.LP	12.33
366BEC-2F75-P	SHUTOFF VALVE W/MNTG FT F75	859.91	38617-312-375-PP	VARI-QUICK S/ASB.LP	15.14
366BEC-3LQ-DN	SHUTOFF NEG VALVE W/ MNTG FT LQC	859.91	38617-312-500-NYB	VARI-QUICK S/ASB.LP	12.33
366BR-2LQ-06D	6RPM 3SEC R REG VALVE W/ MNTG FT LQC	991.88	38617-312-500-PP	VARI-QUICK S/ASB.LP	15.14
37149	3 PIN DIN CONN	22.91	38617-312-750-NYB	VARI-QUICK S/ASB.LP	12.33
37149-1	4 PIN DIN CONN	16.68	38617-312-750-PP	VARI-QUICK S/ASB.LP	15.14
37270-122-1/2-PP-100	STRAINER POLYPRO	105.96	38618A-1-NYB	TURRET NOZZLE,LP	31.18
37270-122-1/2-PP-16	STRAINER POLYPRO	105.96	38618A-1/2-NYB	TURRET NOZZLE	31.18
37270-122-1/2-PP-200	STRAINER POLYPRO	105.96	38618A-3/4-NYB	TURRET NOZZLE,LP	31.18
37270-122-1/2-PP-30	STRAINER POLYPRO	105.96	38720-PPB-X12	ADJ CONEJET TIP	9.82
37270-122-1/2-PP-50	STRAINER POLYPRO	105.96	38720-PPB-X18	ADJ CONEJET TIP	9.82
37270-122-1/2-PP-80	STRAINER POLYPRO	105.96	38720-PPB-X26	ADJ CONEJET TIP	9.82
37270-122-3/4-PP-100	STRAINER POLYPRO	105.96	38720-PPB-X8	ADJ CONEJET TIP	9.82
37270-122-3/4-PP-30	STRAINER POLYPRO	105.96	39188-8400-406-SS	HOSE SHANK ASBLY	51.19
37270-122-3/4-PP-50	STRAINER POLYPRO	105.96	39188-8400-406-SS-10	HOSE SHANK ASBLY 10#	51.19
37270-122-3/4-PP-80	STRAINER POLYPRO	105.96	39188-8400-540-SS	HOSE SHANK ASBLY	55.95
37270-122-3/4-PP-100	STRAINER POLYPRO	105.96	39188-8400-540-SS-10	HOSE SHANK ASBLY 10#	55.95
37270-122-3/4-PP-30	STRAINER POLYPRO	105.96	39189-8400-406-SS	11/16X406 HOSE SHANK	29.59
37270-122-3/4-PP-50	STRAINER POLYPRO	105.96	39189-8400-540-SS	11/16X540 HOSE SHANK	32.36
37270-122-3/4-PP-80	STRAINER POLYPRO	105.96	39831-05	POSITIVE CTRL CABLE	8.98
37740-PP-1/4	TRIGGERJET SPRAY GUN	39.43	39831-15	POSITIVE CTRL CABLE	23.38
37740-PP-300	TRIGGERJET SPRAY GUN	39.43	39831-30	POSITIVE CTRL CABLE	37.27
37740-PP-406	TRIGGERJET SPRAY GUN	39.43	39831-40	POSTITIVE CTRL CABLE	50.52
38082-05	DIN CON CBL 1/2 METR	45.40	39831-50	POSITIVE CTRL CABLE	59.74
38082-05-CS	DIN CON CBL 1/2 METR	66.96	39831-60	POSITIVE CTRL CABLE	62.03
38082-05-EC	DIN CON CBLE 1.5 M	66.96	39910-1-VI	MOUNTING KIT	49.11
38082-05-OB	DIN CON CBL 1/2 METR	66.96	39910-2-VI	MOUNTING KIT	85.01
38082-05-OC	DIN CON CBL 1/2 METR	66.96	39910-3-VI	MOUNTING KIT	127.92
38082-05-OO	DIN CON CBL 1/2 METR	66.96	39910-4-VI	MOUNTING KIT	167.44
38082-05-UG	DIN CON CBL 1/2 METR	66.96	39910-5-VI	MOUNTING KIT	204.01
38082-05-VX	DIN CON CBL 1/2 METR	66.96	39910-6-VI	MOUNTING KIT	236.51
38082-05-WB	DIN CON CBL 1/2 METR	66.96	39920-144A	DIRECTOVALVE,VIWPLUG	274.38
38082-15	DIN CON CBLE 1.5 M	77.34	4067-SS-100	TEEJET CUP STR.,SS	2.37
38082-15-CS	DIN CON CBLE	98.89	4067-SS-20	TEEJET CUP STR.,SS	2.37
38082-30	DIN CON CABL,3 METER	77.34	4067-SS-200	TEEJET CUP STR.,SS	2.37
38082-30-UK	DIN CON CABLE 3 METER	98.89	4067-SS-50	TEEJET CUP STR.,SS	2.37
38082-60	DIN CON CABLE 6METER	77.34	4183B-1/4TA	TEEJET ANGLE BODY,BR	67.52
38166-7715-24	EXTENSION ASB.,BRASS	41.34	4193A-20-100SS	TEEJET CHK VLV, W/20 LB. SPRING #100 MESH SCREEN-BRASS	7.50
38183-124-1-1/2-AL	STRAINER L/SCR.ALUM	183.93	4193A-20-200SS	TEEJET CK VLV , W/20 LB. SPRING #200 MESH SCREEN-BRASS	7.50
38183-124-1-1/2-I	STRAINER L/SCR.IRON	186.15	4193A-20-24SS	TEEJET CK VLV ,W/20 LB. SPRING #24 MESH SCREEN-BRASS	7.50
38183-124-1-1/4-AL	STRAINER L/SCR.ALUM	183.93	4193A-20-50SS	TEEJET CK VLV , W/20 LB. SPRING #50 MESH SCREEN-BRASS	7.50
38185-124A-1-I	STRAINER L/SCR.IRON	117.50	4193A-40-100SS	TEEJET CK.VLV, W/40 LB. SPRING 100 MESH SCREEN-BRASS	7.50
38612-211-406-NYB	BODY SUB ASB QJ211LP	14.91	4193A-40-200SS	TEEJET CK.VLV, W/40 LB. SPRNG 200 MESH SCREEN-BRASS	7.50
38612-211-540-NYB	BODY SUB ASB QJ211LP	14.91	4193A-40-24SS	TEEJET CK VLV, W/40 LB. SPRING 24 MESH SCREEN-BRASS	7.50
38612-211-785-NYB	BODY SUB ASB QJ211LP	14.91	4193A-40-50SS	TEEJET CK VLV, W/40 LB. SPRING 50 MESH SCREEN-BRASS	7.50
38613-212-406-NYB	BODY SUB ASB QJ212LP	14.91	4193A-AL-20-50SS	TEEJET CHECK VALVE, AL	7.25
38613-212-540-NYB	BODY SUB ASB QJ212LP	14.91	4193A-AL-40-50SS	TEEJET CHECK VALVE, AL	7.25
38613-212-785-NYB	BODY SUB ASB QJ212LP	14.91	4193A-PP-2-24SS	TEEJET CHECK VALVE, PP	5.96
38614-213-406-NYB	BODY SUB ASB QJ213LP	14.91			
38614-213-540-NYB	BODY SUB ASB QJ213LP	14.91			
38614-213-785-NYB	BODY SUB ASB QJ213LP	14.91			
38615A-1-540-NYB	QT HOSESHK,TRIPLE LP	32.02			
38615A-1-785-NYB	QT HOSESHK,TRIPLE LP	32.02			
38615A-2-540-NYB	QT HOSESHK,TRIPLE LP	32.02			
38615A-2-785-NYB	QT HOSESHK,TRIPLE LP	32.02			



PART NO.	DESCRIPTION	U.S.DOLLARS	PART NO.	DESCRIPTION	U.S.DOLLARS
4193A-PP-2-50SS	#2 LB. SPRING TEEJET CHECK VALVE, PP	5.96	4193B-PP-10-24SS	TEEJET CK VLV , PP W/10 LB. SPRING-#24 MESH SCREEN WHITE	5.96
4193A-PP-20-100SS	TEEJET CHECK VALVE, PP	5.96	4193B-PP-10-50SS	TEEJET CK VLV , PP W/10 LB. SPRING 50 MESH BLUE	5.96
4193A-PP-20-200SS	TEEJET CHECK VALVE, PP	5.96	4193B-PP-10-80SS	TEEJET CK VLV , PP	5.96
4193A-PP-20-24SS	#20 LB. SPRING TEEJET CHECK VALVE, PP	5.96	4193B-PP-10-SS-100SS	TEEJET CK VLV, PP #10 LB. SPRING W/SS BALL#100 MESH BODY GREEN - HOT BALL	10.40
4193A-PP-20-50SS	#20 LB. SPRING W/50 MESH TEEJET CHECK VALVE, PP	5.96	4193B-PP-10-SS-200SS	TEEJET CK VLV , PP #10 LB. SPRING W/SS BALL#200 MESH SCREEN PINK	10.40
4193A-PP-20-SS-100SS	STRAINER W/SS BALL	10.40	4193B-PP-10-SS-24SS	TEEJET CK VLV , PP #10 LB. SPRING W/SS BALL#24 MESH SCREEN WHITE	10.40
4193A-PP-20-SS-200SS	CHECK VLV. W/SS BALL	10.40	4193B-PP-10-SS-50SS	TEEJET CK VLV , PP #10 LB. SPRING W/SS BALL#50 MESH SCREEN BLUE	10.40
4193A-PP-20-SS-24SS	STRAINER W/SS BALL	10.40	4193B-PP-10-SS-80SS	TEEJET CK VLV , PP #10 LB. SPRING W/SS BALL#80 MESH SCREEN YELLOW	10.40
4193A-PP-20-SS-50SS	STRAINER W/SS BALL (HOT-BALL)	10.40	4193B-PP-5-100SS	TEEJET CK VLV , PP W/5 LB. SPRING #100 MESH SCREEN GREEN	5.96
4193A-PP-20-SS-80SS	STRAINER W/SS BALL	10.40	4193B-PP-5-200SS	TEEJET CK VLV, #5 LB. SPRING W/200 MESH PINK	5.96
4193A-PP-40-100SS	#40 LB. SPRING TEEJET CHECK VALVE, PP	5.96	4193B-PP-5-24SS	TEEJET CK VLV , PP- W/5 LB. SPRING-#24 MESH SCREEN WHITE	5.96
4193A-PP-40-200SS	40 LB. SPRING RED COLOR -200 MESH TEEJET CHECK VALVE, PP	5.96	4193B-PP-5-50SS	TEEJET CK VLV , PP W/5 LB. SPRING, #50 MESH SCREEN BLUE	5.96
4193A-PP-40-24SS	TEEJET CHECK VALVE, PP	5.96	4193B-PP-5-80SS	TEEJET CK VLV , PP	5.96
4193A-PP-40-50SS	TEEJET CHECK VALVE, PP	5.96	4193B-PP-5-SS-100SS	TEEJET CK VLV, PP #5 LB. SPRING W/SS BALL#100 MESH BODY GREEN HOT BALL	10.40
4193A-PP-40-SS-100SS	TEEJET CHECK VALVE, PP	10.40	4193B-PP-5-SS-200SS	TEEJET CK VLV, PP #5 LB. SPRING W/SS BALL#200 MESH PINK-HOT BALL	10.40
4193A-PP-40-SS-50SS	TEEJET CHECK VALVE, PP	10.40	4193B-PP-5-SS-24SS	TEEJET CK VLV , PP #5 LB. SPRING W/SS BALL#24 MESH SCREEN WHITE	10.40
4193A-SS-20-100SS	TEEJET CHECK VALVE, SS	29.45	4193B-PP-5-SS-50SS	TEEJET CK VLV, PP #5 LB. SPRING W/SS BALL#50 MESH SCREEN HOT BALL	10.40
4193A-SS-20-200SS	TEEJET CHECK VALVE, SS	29.45	4193B-PP-5-SS-80SS	TEEJET CK VLV , PP #5 LB. SPRING W/SS BALL#80 YELLOW	10.40
4193A-SS-20-24SS	TEEJET CHECK VALVE, SS	29.45	4193B-SS-10-100SS	TEEJET CK VLV, SS #10 LB. SPRING 100 MESH	29.45
4193A-SS-20-50SS	TEEJET CHECK VALVE, SS	29.45	4193B-SS-10-200SS	TEEJET CK VLV, SS #10 LB. SPRING 200 MESH	29.45
4193A-SS-40-100SS	TEEJET CHECK VALVE, SS	29.45	4193B-SS-10-24SS	TEEJET CHECK VALVE, SS	29.45
4193A-SS-40-200SS	TEEJET CHECK VALVE, SS	29.45	4193B-SS-10-50SS	TEEJET CHECK VALVE, SS	29.45
4193A-SS-40-24SS	TEEJET CHECK VALVE, SS	29.45	4193B-SS-5-100SS	TEEJET CHECK VALVE, SS	29.45
4193A-SS-40-50SS	TEEJET CHECK VALVE, SS	29.45	4193B-SS-5-200SS	TEEJET CHECK VALVE, SS	29.45
4193B-10-100SS	TEEJET CK VLV , BR #10 LB. SPRING #100 MESH SCREEN	7.50	4193B-SS-5-24SS	TEEJET CHECK VALVE, SS	29.45
4193B-10-200SS	TEEJET CK VLV , BR #10 LB. SPRING #200 MESH SCREEN	7.50	4193B-SS-5-50SS	TEEJET CHECK VALVE, SS	29.45
4193B-10-24SS	TEEJET CK VLV , BR #10 LB. SPRING #24 MESH SCREEN	7.50	4193B-SS-5-80SS	TEEJET CHECK VALVE, SS	29.45
4193B-10-50SS	TEEJET CK VLV , BR #10 LB. SPRING #50 MESH SCREEN	7.50	4202-2-1/4T	TEEJET SW.BDY ASB,BR	36.00
4193B-10-80SS	TEEJET CK VLV , BR #10 LB. SPRING #80 MESH SCREEN	7.50	4251-250	TEEJET HOSE SHANK, BR	4.84
4193B-5-100SS	TEEJET CK VLV , BR #5 LB. SPRING #100 MESH SCREEN	7.50	4251-250-SS	TEEJET HOSE SHANK, SS	9.95
4193B-5-200SS	TEEJET CK VLV , BR #5 LB. SPRING #200 MESH SCREEN	7.50	4251-312	TEEJET HOSE SHANK, BR	4.84
4193B-5-24SS	TEEJET CK VLV , BR #5 LB. SPRING #24 MESH SCREEN	7.50	4251-312-SS	TEEJET HOSE SHANK, SS	9.95
4193B-5-50SS	TEEJET CHECK VALVE , BR W/5 LB. SPRING #50 MESH SCREEN	7.50	4251-375	TEEJET HOSE SHANK, BR	4.84
4193B-5-80SS	TEEJET CK VLV , BR #5 LB. SPRING #80 MESH SCREEN	7.50	4251-375-SS	TEEJET HOSE SHANK, SS	9.95
4193B-AL-10-100SS	TEEJET CHECK VALVE, AL #10 LB. SPRING 100 MESH	7.25	4251-400	TEEJET HOSE SHANK, BR	4.84
4193B-AL-10-200SS	TEEJET CHECK VALVE, AL	7.25	4251-400-SS	TEEJET HOSE SHANK, SS	9.95
4193B-AL-10-24SS	TEEJET CHECK VALVE, AL	7.25	4251-437	TEEJET HOSE SHANK, BR	4.84
4193B-AL-10-50SS	TEEJET CHECK VALVE, AL	7.25			
4193B-AL-10-80SS	TEEJET CHECK VALVE, AL	7.25			
4193B-AL-5-100SS	TEEJET CHECK VALVE, AL	7.25			
4193B-AL-5-200SS	TEEJET CHECK VALVE, AL	7.25			
4193B-AL-5-24SS	TEEJET CHECK VALVE, AL	7.25			
4193B-AL-5-50SS	TEEJET CHECK VALVE, AL	7.25			
4193B-AL-5-80SS	TEEJET CHECK VALVE, AL	7.25			
4193B-PP-10-100SS	TEEJET CK VLV , PP W/10 LB. SPRING 100 MESH GREEN	5.96			
4193B-PP-10-200SS	#200 MESH TEEJET CHECK VALVE , PP-PINK	5.96			

PART NO.	DESCRIPTION	U.S.DOLLARS	PART NO.	DESCRIPTION	U.S.DOLLARS
4251-500	TEEJET HOSE SHANK, BR	4.84	432EC-3F75-DN	430EC-3 MANIFOLD	802.39
4251-500-SS	TEEJET HOSE SHANK, SS	9.95	432EC-3FB-D	430EC-3FB MANIFOLD	680.86
430E-2-D	430E-2 RPL ASSY	277.05	432EC-3FBF75-D	430EC-3FB MANIFOLD	661.02
430E-3-D	430E-3 RPL ASSY	382.33	433E-2-D	430E-2 MANIFOLD	907.26
430E-3FB-D	430E-3FB RPL ASSY	328.26	433E-3-D	430E-3 MANIFOLD	1170.52
430EC-2-D	430EC-2 RPL ASSY	277.05	433E-3F75-D	430E-3 MANIFOLD	1170.52
430EC-2-P	430EC-2 RPL ASSY	255.63	433E-3FB-D	430E-3FB MANIFOLD	989.96
430EC-3-D	430EC-3 RPL ASSY	382.33	433EC-2-D	430EC-2 MANIFOLD	907.26
430EC-3FB-D	430EC-3FB RPL ASSY	328.26	433EC-2-P	430EC-2 MANIFOLD	843.06
4310E-2-D	430E-2 MANIFOLD	3028.44	433EC-2F75-D	430EC-2 MANIFOLD	907.26
4310EC-2-D	4310EC-2-D	3028.44	433EC-3-D	430EC-3 MANIFOLD	1170.52
4310EC-2-P	4310EC-2-P 2WAY METRI-PACK MANIFOLD	2814.41	433EC-3-P	430EC-3 MANIFOLD	1047.06
4310EC-3-D	430EC-3 MANIFOLD	3884.66	433EC-3F75-D	430EC-3 MANIFOLD	1170.52
4310EC-3F75-D	430EC-3 F75 MANIFOLD	3884.66	433EC-3F75-P	430 BYPASS MANIFOLD	925.74
4310EC-3FB-D	430EC-3 MANIFOLD	3299.55	433EC-3FB-D	430EC-3FB MANIFOLD	989.96
4310EC-3FBF75-D	430EC-3FB F75 MANIFOLD	3299.55	433EC-3FBF75-D	430EC-3FB MANIFOLD	989.96
4311E-3FB-D	430E-3FB MANIFOLD	3639.57	434E-2-D	430E-2 MANIFOLD	1212.69
4311EC-2-D	430EC-2 MANIFOLD	3334.79	434E-2F75-D	430E-2 MANIFOLD	1212.69
4311EC-2-P	4311EC-2-P 2-WAY METRI-PACK MANIFOLD	3099.36	434E-3-D	430E-3 MANIFOLD	1566.19
4311EC-2F75-D	430EC-2 F75 MANIFOLD	3334.79	434E-3FB-D	430E-3FB MANIFOLD	1319.86
4311EC-3FB-D	430EC-3FB MANIFOLD	3512.02	434EC-2-D	430EC-2 MANIFOLD	1212.69
4311EC-3FBF75-D	430EC-3FB F75 MANIFOLD	3710.82	434EC-2-P	430EC-2 MANIFOLD	1127.06
4311EC-3FBF75-DN	430EC FB F75 NEGATIVE SWITCH	3710.82	434EC-2-PN	430EC-2 MANIFOLD	1212.69
4312E-3FB-D	430E-3FB MANIFOLD	3968.92	434EC-2F75-D	430EC 2WAY F75 MANIFOLD	1212.69
4312EC-2-D	430EC-2 MANIFOLD	3637.95	434EC-2F75-P	430EC-2 METRI-PACK MANIFOLD	1127.06
4312EC-2-P	4312EC-2-P 2-WAY METRI-PACK MANIFOLD	3381.12	434EC-3-D	430EC-3 MANIFOLD	1566.19
4312EC-2F75-D	430EC 2WAY F75 MANIFOLD	3637.95	434EC-3-P	430EC-3 MANIFOLD	1480.58
4312EC-3-D	430EC-3 MANIFOLD	4670.36	434EC-3F75-D	430EC-3 MANIFOLD	1566.19
4312EC-3FBF75-D	430EC-3FB F75 MANIFOLD	3916.82	434EC-3FB-D	430EC-3FB MANIFOLD	1319.86
4313E-3FB-D	430E-3FB MANIFOLD	4300.76	434EC-3FBF75-D	430EC-3FB F75 MANIFOLD	1319.86
4313EC-2-P	4313EC-2-P 2-WAY METRI-PACK MANIFOLD	3663.51	435E-2-D	430E-2 MANIFOLD	1515.88
4313EC-3FB-D	430EC-3FB MANIFOLD	4300.76	435E-3-D	430E-3 MANIFOLD	1976.22
4314EC-2-P	4314EC-2-P 2-WAY METRI-PACK MANIFOLD	3945.91	435E-3FB-D	430E-3FB MANIFOLD	1649.93
4315EC-2-D	430EC-2 MANIFOLD	4549.34	435EC-2-D	430EC-2 MANIFOLD	1515.88
4315EC-2-P	4315EC-2-P 2-WAY METRI-PACK MANIFOLD	4228.29	435EC-2-P	435EC-2-P 2-WAY METRI-PACK MANIFOLD	1408.85
431E-2-D	430E-2 MANIFOLD	344.54	435EC-2F75-D	430EC-2 MANIFOLD F75	1515.88
431E-3-D	430E-3 MANIFOLD	412.75	435EC-2F75-P	430EC-2 METRI-PACK MANIFOLD F75	1408.85
431E-3F75-D	430 3-WAY F75 MANIFOLD	412.75	435EC-3-D	430EC-3 MANIFOLD	1976.22
431E-3FB-D	430E-3FB MANIFOLD	372.11	435EC-3F75-D	430EC-3F MANIFOLD	1976.22
431EC-2-D	430EC-2 MANIFOLD	344.54	435EC-3FB-D	430EC-3FB MANIFOLD	1649.93
431EC-2-P	431EC-2-P 2-WAY MANIFOLD BALL VALVE	323.13	435EC-3FBF75-D	430EC-3FB F75 MANIFOLD	1649.93
431EC-2F75-D	430 2WAY F75 MANIFOLD	344.54	435EC-3FBF75-DN	430EC FB F75 NEGATIVE SWITCH	1649.93
431EC-3-D	430EC-3 MANIFOLD	412.75	435EC-3FBF75-P	430EC-3FB F75 MANIFOLD	3751.82
431EC-3F75-D	430 3-WAY F75 MANIFOLD	412.75	436E-2-D	430E-2 MANIFOLD	1818.39
431EC-3F75-P	430 3-WAY F75 MANIFOLD	391.35	436E-3-D	430E-3 MANIFOLD	2347.74
431EC-3FB-D	430EC-3FB MANIFOLD	372.11	436E-3FB-D	430E-3FB MANIFOLD	1990.93
431EC-3FBF75-D	430 FLOWBACK F75 MANIFOLD	372.11	436EC-2-D	430EC-2 MANIFOLD	1818.39
432E-2-D	430E-2 MANIFOLD	625.76	436EC-2-P	436EC-2-P 2-WAY MANIFOLD BALL VALVE	1689.97
432E-2F75-D	430E 2WAY F75 MANIFOLD	625.76	436EC-2F75-D	430EC 2WAY F75 MANIF	1818.39
432E-3-D	430E-3 MANIFOLD	802.39	436EC-2F75-P	430EC 2WAY F75 MANIFOLD	1690.00
432E-3F75-D	430E 3WAY F75 MANIFOLD	802.39	436EC-3-D	430EC-3 MANIFOLD	2347.74
432E-3FB-D	430E-3FB MANIFOLD	680.86	436EC-3F75-D	430EC-3 F75 MANIFOLD	2347.74
432EC-2-D	430EC-2 MANIFOLD	625.76	436EC-3FB-D	430EC-3FB MANIFOLD	1990.93
432EC-2-P	430EC-2 METRI-PACK MANIFOLD	582.97	436EC-3FBF75-D	430 MANIFOLD	1990.93
432EC-2F75-D	430EC-2 MANIFOLD	625.76	437E-2-D	430E-2 MANIFOLD	2122.20
432EC-2F75-P	430EC-2 METRI-PACK MANIFOLD	582.97	437E-3-D	430E-3 MANIFOLD	2739.29
432EC-3-D	430EC-3 MANIFOLD	802.39	437E-3FB-D	430E-3FB MANIFOLD	2309.83
432EC-3F75-D	430EC-3 MANIFOLD	802.39	437EC-2-D	430EC-2 MANIFOLD	2122.20
			437EC-2-P	437EC-2-P 2-WAY MANIFOLD BALL VALVE	1972.38
			437EC-2F75-D	430EC-2 F75 MANIFOLD	2122.20

PART NO.	DESCRIPTION	U.S.DOLLARS	PART NO.	DESCRIPTION	U.S.DOLLARS
437EC-3-D	430EC-3 MANIFOLD	2739.29	441BEC-F4T4T-C	440 MANIFOLD F	575.44
437EC-3FB-D	430EC-3FB MANIFOLD	2309.83	441BEC-F4T4T-COC	440 MANIFOLD	597.39
437EC-3FBF75-D	430EC-3FB MANIFOLD	2309.83	441BEC-Q4HB-C	440 MANIFOLD	575.44
437EC-3FBF75-DN	430EC FB F75 NEGATIVE SWITCH	2309.83	442BEC-34T1T-C	MANIFOLD BALL VAVLE	1112.67
438E-2-D	430E-2 MANIFOLD	2425.35	442BEC-34T4T-C	MANIFOLD BALL VALVE	1112.67
438E-2F75-D	430E-2 MANIFOLD	2425.35	442BEC-34T4T-C60	440 MANIFOLD	1218.76
438E-3-D	430E-3 MANIFOLD	3120.83	442BEC-34T4T-CVX	440 MANIFOLD	1156.68
438E-3FB-D	430E-3FB MANIFOLD	2639.49	442BEC-34TB-C	440 MANIFOLD	1112.67
438EC-2-D	430EC-2 MANIFOLD	2425.35	442BEC-3B4T-C	440 MANIFOLD	1112.67
438EC-2-P	438EC-2-P 2-WAY MANIFOLD BALL VALVE	2254.12	442BEC-3B4T-CN15	440 MANIFOLD	1141.35
438EC-2F75-D	430EC-2 F75 MANIFOLD	2425.35	442BEC-3S4T4T-C	440 MANIFOLD	1357.90
438EC-3-D	430EC-3 MANIFOLD	3120.83	442BEC-3S4T4T-C15	440 MANIFOLD	1386.67
438EC-3F75-D	430EC-3 MANIFOLD	3120.83	442BEC-44T1T-CVX	440 MANIFOLD	1156.68
438EC-3FB-D	430EC-3FB MANIFOLD	2639.49	442BEC-44T4T-C	440 MANIFOLD	1112.67
439E-2-D	430E-2 MANIFOLD	2728.51	442BEC-44T4T-CK	440 MANIFOLD	1134.58
439E-3-D	430E-3 MANIFOLD	3502.38	442BEC-44T4T-COC	440 MANIFOLD	1156.68
439E-3FB-D	430E-3FB MANIFOLD	3029.15	442BEC-44T4T-CVX	440 MANIFOLD	1156.68
439EC-2-D	430EC-2 MANIFOLD	2728.51	442BEC-44TB-CPG	440 MANIFOLD	1156.68
439EC-2-P	430EC-2 MANIFOLD	2535.89	442BEC-4S4T4T-C	440 MANIFOLD SS	1357.90
439EC-2F75-D	430EC-2 MANIFOLD	2728.51	442BEC-4S4T4T-COC	440 MANIFOLD SS	1379.92
439EC-3-D	430EC-3 MANIFOLD	3502.38	442BEC-4S4T4T-D	440 MANIFOLD	1357.90
439EC-3FB-D	430EC-3FB MANIFOLD	3029.15	442BEC-F4T4T-C	440 MANIFOLD	1112.67
439EC-3FBF75-D	430EC-3FB MANIFOLD	3029.15	442BEC-F4T4T-COC	440 MANIFOLD	1156.68
439EC-3FBF75-DN	430EC FB F75 NEGATIVE SWITCH	3029.15	442BEC-F4T4T-CPB	440 MANIFOLD	1156.68
440BE-3-C	440 REPLACEMENT VALV	480.73	442BEC-FS4T1T-C	440 MANIFOLD	1357.90
440BE-4-C	REPLACEMENT/VALV ASB	480.73	442BEC-Q4H1T-C	440 MANIFOLD	1112.67
440BE-4-CPC	REPLACEMENT/VLVE ASB	502.70	442BEC-Q4T4T-C	440 MANIFOLD	1112.67
440BE-4-CUC	REPLACEMENT/VALV ASB	502.70	442BEC-QS4T4T-CVX	440 MANIFOLD SS	1379.92
440BE-4S-C	440 MANIFOLD SS	603.34	443BE-34T4T-C	440 MANIFOLD	1656.90
440BE-4S-CPG	440 MANIFOLD SS	625.35	443BE-44T4T-C	440 MANIFOLD	1656.90
440BEC-3-C	REPLACEMENT/VLVE ASB	480.73	443BE-44T4T-CJ	440 MANIFOLD	1689.97
440BEC-3S-C	440 MANIFOLD SS	603.34	443BE-QS5H4T-C15	440 MANIFOLD SS	2067.93
440BEC-4-C	REPLACEMENT/VLVE ASB	480.73	443BE-QS5HB-C15	440 MANIFOLD SS	2067.93
440BEC-4-COB	REPLACEMENT/VLVE ASB	502.70	443BEC-34H1T-C	440 MANIFOLD	1656.90
440BEC-4-COC	REPLACEMENT/VLVE ASB	502.70	443BEC-34H4T-C	440 MANIFOLD	1656.90
440BEC-4S-C	440 MANIFOLD SS	603.34	443BEC-34HB-C	440 MANIFOLD	1656.90
440BEC-F-C	REPLACEMENT/VLVE ASB	480.73	443BEC-34HB-P	440 MANIFOLD LESS CABLE	1592.71
440BEC-F-C15	REPLACEMENT/VLVE ASB	494.84	443BEC-34T1T-C	440 MANIFOLD	1656.90
440BEC-FS-C	REPLACEMENT/VLVE SS	603.34	443BEC-34T1T-CJ	440 MANIFOLD	1689.97
440BEC-Q-C	REPLACEMENT/VLVE ASB	480.73	443BEC-34T1T-COB	440 MANIFOLD	1722.73
440BEC-Q-CJ	REPLACEMENT/VLVE ASB	491.77	443BEC-34T1T-CVX	440 MANIFOLD	1722.73
440BEC-Q-COC	440BEC-Q-C REPLACEMENT VALVE ASB	502.70	443BEC-34T4T-C	440 MANIFOLD	1656.90
440BEC-QS-CN	REPLACEMENT/VLVE SS	603.34	443BEC-34T4T-C15	440 MANIFOLD	1700.02
4418-3/4-2TOC06	BOOMJET NOZ,BRASS	331.50	443BEC-34T4T-C60	440 MANIFOLD	1816.02
4418-3/4-2TOC10	BOOMJET NOZ,BRASS	331.50	443BEC-34T4T-C60VX	440 MANIFOLD	1881.85
4418-3/4-2TOC150	BOOMJET NOZ,BRASS	331.50	443BEC-34T4T-CJ	440 MANIFOLD	1689.97
4418-3/4-2TOC20	BOOMJET NOZ,BRASS	331.50	443BEC-34T4T-CK	440 MANIFOLD	1689.97
4418-3/4-2TOC30	BOOMJET NOZ,BRASS	331.50	443BEC-34T4T-CLS	440 MANIFOLD	1722.73
4418-3/4-2TOC300	BOOMJET NOZ,BRASS	331.50	443BEC-34T4T-CVX	440 MANIFOLD	1722.73
4418-3/4-2TOC40	BOOMJET NOZ,BRASS	331.50	443BEC-34T4T-P	440 MANIFOLD	1592.70
4418-3/4-2TOC60	BOOMJET NOZ,BRASS	331.50	443BEC-34TB-C	440 MANIFOLD	1656.90
4418-3/4-2TOC80	BOOMJET NOZ,BRASS	331.50	443BEC-34TB-C15	440 MANIFOLD	1700.02
441BE-44T4T-C	440 MAINFOLD	575.44	443BEC-34TB-COB	440 MANIFOLD	1722.73
441BE-F4T4T-C	440 MANIFOLD	575.44	443BEC-34TB-COC	440 MANIFOLD	1722.73
441BEC-34T1T-C	440 MANIFOLD	575.44	443BEC-35H4T-C	440 MANIFOLD	1656.90
441BEC-34T4T-C	440 MANIFOLD	575.44	443BEC-35H4T-C	440 MANIFOLD	1656.90
441BEC-44T1T-CVX	440 MANIFOLD	597.39	443BEC-35H4T-C	440 MANIFOLD	1656.90
441BEC-44T4T-C	440 MANIFOLD	575.44	443BEC-35H4T-C	440 MANIFOLD	1656.90
441BEC-44T4T-C15	440 MANIFOLD	589.76	443BEC-35H4T-C	440 MANIFOLD	1656.90
441BEC-44T4T-COC	440 MANIFOLD	597.39	443BEC-35H4T-C	440 MANIFOLD	1656.90
441BEC-44T4T-CVX	440 MANIFOLD	597.39	443BEC-35H4T-C	440 MANIFOLD	1656.90
441BEC-4S4T4T-C	440 MANIFOLD SS	698.06	443BEC-35H4T-C	440 MANIFOLD	1656.90
			443BEC-35H4T-C	440 MANIFOLD SS	2024.78
			443BEC-35H4T-CVX	440 MANIFOLD SS	2090.65
			443BEC-35HB-C15	440 MANIFOLD SS	2067.93
			443BEC-35T1T-C	440 MANIFOLD SS	2024.78
			443BEC-35T1T-C60	440 MANIFOLD SS	2183.90
			443BEC-3S4T4T-C	440 MANIFOLD SS	2024.78
			443BEC-3S4T4T-C15	440 MANIFOLD SS	2067.93
			443BEC-3S4T4T-CVX	440 MANIFOLD SS	2090.65

PART NO.	DESCRIPTION	U.S.DOLLARS	PART NO.	DESCRIPTION	U.S.DOLLARS
443BEC-3S4TB-C	440 MANIFOLD SS	2024.78	444BEC-44T4T-CJ	440 MANIFOLD	2241.98
443BEC-3S4TB-C15	440 MANIFOLD SS	2067.93	444BEC-44T4T-COC	440 MANIFOLD	2285.70
443BEC-3SB4T-C15	440 MANIFOLD SS	2067.93	444BEC-4S4T1T-C	440 MANIFOLD SS	2688.25
443BEC-44H4H-C	440 MANIFOLD	1656.90	444BEC-4S4T4T-C	440 MANIFOLD SS	2688.25
443BEC-44H4T-C	440 MANIFOLD	1656.90	444BEC-4S4T4T-CN15	440 MANIFOLD SS	2745.76
443BEC-44HB-C	440 MANIFOLD	1656.90	444BEC-4S4T4T-COC	440 MANIFOLD SS	2710.26
443BEC-44T1T-C	440 MANIFOLD	1656.90	444BEC-4S5H4T-C03	440 MANIFOLD SS	2688.25
443BEC-44T1T-CUX	440 MANIFOLD	1722.73	444BEC-F4T4T-C	440 MANIFOLD	2197.84
443BEC-44T1T-CVX	440 MANIFOLD	1722.73	444BEC-F54HB-C	440 MANIFOLD SS	2688.25
443BEC-44T1T-P	440 MANIFOLD LESS CABLE	1592.70	444BEC-F54T4T-C15	440 MANIFOLD SS	2745.76
443BEC-44T4H-C	440 MANIFOLD	1656.90	444BEC-Q1T4T-C	440 MANIFOLD	2197.84
443BEC-44T4T-C	440 MANIFOLD	1656.90	444BEC-Q1T4T-P	440 MANIFOLD	2112.23
443BEC-44T4T-C15	440 MANIFOLD	1700.02	444BEC-Q5H1T-C	440 MANIFOLD	2197.84
443BEC-44T4T-C60VX	440 MANIFOLD 1"	1881.85	444BEC-QS5HB-C15	440 MANIFOLD SS	2745.76
443BEC-44T4T-CJ	440 MANIFOLD	1689.97	445BE-44T4T-C	440 MANIFOLD	2735.76
443BEC-44T4T-COB	440 MANIFOLD	1722.73	445BE-45H1T-C	440 MANIFOLD	2735.76
443BEC-44T4T-COC	440 MANIFOLD	1722.73	445BE-45S5H1T-C	440 MANIFOLD SS	3348.90
443BEC-44T4T-COG	440 MANIFOLD	1722.73	445BE-QS5H4T-C15	440 MANIFOLD SS	3420.69
443BEC-44T4T-CPG	440 MANIFOLD	1722.73	445BE-QS5HB-C15	440 MANIFOLD SS	3420.69
443BEC-44T4T-CVX	440 MANIFOLD	1722.73	445BEC-34T1T-COB	440 MANIFOLD	2845.47
443BEC-44T4T-P	440 MANIFOLD LESS CABLE	1592.71	445BEC-34T1T-COC	440 MANIFOLD	2845.47
443BEC-44T5H-C	440 MANIFOLD	1656.90	445BEC-34T4T-C	440 MANIFOLD	2735.76
443BEC-44TB-C	440 MANIFOLD	1656.90	445BEC-34T4T-C15	440 MANIFOLD	2807.64
443BEC-44TB-COC	440 MANIFOLD	1722.73	445BEC-34T4T-CK	440 MANIFOLD	2790.73
443BEC-45H4T-C	440 MANIFOLD	1656.90	445BEC-34TB-C	440 MANIFOLD	2735.76
443BEC-4B4T-CTS	440 MANIFOLD	1722.73	445BEC-34TB-C15	440 MANIFOLD	2750.16
443BEC-4S4T4T-C	440 MANIFOLD SS	2024.78	445BEC-3S4T4T-C	440 MQANIFOLD SS	3348.90
443BEC-4S4T4T-C03	440 MANIFOLD SS	2024.78	445BEC-3S4T4T-C15	440 MQANIFOLD SS	3420.65
443BEC-4S4T4T-C60	440 MANIFOLD SS	2076.78	445BEC-3S4T4T-CVX	440 MANIFOLD SS	3458.87
443BEC-4S4T4T-CPS	440 MANIFOLD SS	2090.65	445BEC-3S4T4T-D	440 MQANIFOLD SS	3348.90
443BEC-4S4T4T-CVX	440 MANIFOLD SS	2090.65	445BEC-3SB4T-C15	440 MANIFOLD SS	3420.65
443BEC-4S4TB-C	440 MANIFOLD SS	2024.78	445BEC-44H4H-C	440 MANIFOLD	2735.76
443BEC-4S4TB-COC	440 MANIFOLD SS	2049.65	445BEC-44H4T-C	440 MANIFOLD	2735.76
443BEC-F4H1T-D	440 MANIFOLD	1656.90	445BEC-44T4T-C	440 MANIFOLD	2735.76
443BEC-F4HB-C	440 MANIFOLD	1656.90	445BEC-44T4T-C03PC	440 MANIFOLD	2845.47
443BEC-F4HB-CPC	440 MANIFOLD	1722.73	445BEC-44T4T-CJ	440 MANIFOLD	2790.73
443BEC-F4HB-D	440 MANIFOLD	1656.90	445BEC-44T4T-CK	440 MANIFOLD	2790.73
443BEC-F4T4T-C	440 MANIFOLD	1656.90	445BEC-44T4T-COC	440 MANIFOLD	2845.47
443BEC-F4T4T-COC	440 MANIFOLD	1722.73	445BEC-44T4T-CPG	440 MANIFOLD	2845.47
443BEC-F4T4T-CVX	440 MANIFOLD	1722.73	445BEC-44T4T-CVX	440 MANIFOLD	2845.47
443BEC-F5H4T-C	440 MANIFOLD	1656.90	445BEC-45H5H-C60	450 MANIFOLD	3000.94
443BEC-F54T4T-C	440 MANIFOLD SS	2024.78	445BEC-45HB-C	440 MANIFOLD	2735.76
443BEC-F54T4T-COB	440 MANIFOLD SS	2090.59	445BEC-45H4H-C60J	440 MANIFOLD SS	3669.26
443BEC-Q4T4T-C	440 MANIFOLD	1656.90	445BEC-4S4HB-COG	440 MANIFOLD SS	3458.87
443BEC-Q4T4T-CJ	440 MANIFOLD	1689.97	445BEC-4S4T4T-C	440 MANIFOLD SS	3348.90
443BEC-Q4TB-C	440 MANIFOLD	1656.90	445BEC-4S5H5H-C	440 MANIFOLD SS	3348.90
443BEC-Q5H1T-C	440 MANIFOLD	1656.90	445BEC-F4H4H-C	440 MANIFOLD	2735.76
443BEC-QS4T4T-C	440 MANIFOLD	2024.78	445BEC-F4HB-D	440 MANIFOLD	2735.76
443BEC-QS5HB-C15	440 MANIFOLD SS	2067.93	445BEC-F4T4T-C	440 MANIFOLD	2735.76
443BEC-QSB4T-C60	440 MANIFOLD SS	2076.78	445BEC-F4T4T-COC	440 MANIFOLD	2845.47
444BE-44T4T-C	440 MANIFOLD	2197.84	445BEC-F4TB-D	440 MANIFOLD	2735.76
444BE-QS5H4T-C15	440 MANIFOLD	2745.76	445BEC-Q4HB-D	440 MANIFOLD	2735.76
444BE-QS5HB-C15	440 MANIFOLD SS	2745.76	445BEC-Q5H1T-C	440 MANIFOLD	2735.76
444BEC-34H1T-C	440 MANIFOLD	2197.84	445BEC-Q5HB-COC	440 MANIFOLD	2845.47
444BEC-34T1T-C	440 MANIFOLD	2197.84	445BEC-QS5H4T-C15	440 MANIFOLD SS	3420.69
444BEC-34T1T-CVX	440 MANIFOLD	2219.80	445BEC-QS5HB-C15	440 MANIFOLD SS	3420.69
444BEC-34T4T-C	440 MANIFOLD	2197.84	446BEC-3S4TB-C15	440 MANIFOLD SS	4092.76
444BEC-34T4T-C60PC	440 MANIFOLD	2454.11	45100-1-122ML-1/2	1/2" NPT LESS SCREEN	19.88
444BEC-34T4T-COC	440 MANIFOLD	2285.44	45100-1-122ML-3/4	3/4" NPT LESS SCREEN	19.88
444BEC-34T4T-COU	440 MANIFOLD	2285.44	45100-1-B122ML-1/2	1/2" BSPT LESS SCRIN	19.88
444BEC-3S4T4T-CJ	440 MANIFOLD SS	2732.41	45100-1-B122ML-3/4	3/4" BSPT LESS SCRIN	19.88
444BEC-3SB4T-C15	440 MANIFOLD SS	2703.02	4514-10	TEEJET SLOT.STR,BR.	2.04
444BEC-44T4T-C	440 MANIFOLD	2197.84	4514-20	TEEJET SLOT.STR,BR.	2.04
444BEC-44T4T-C60	440 MANIFOLD	2409.97	4514-32	TEEJET SLOT.STR,BR.	2.04

PART NO.	DESCRIPTION	U.S.DOLLARS	PART NO.	DESCRIPTION	U.S.DOLLARS
4514-40	TEEJET SLOT.STR,BR.	2.04	451BEC-2NQ-C60-R6	451BEC -2N R6 CB MOTOR	563.98
4514-AL-20	TEEJET SLOT.STR,AL.	1.97	451BEC-2NQ-COB	450N MANIFOLD	494.61
4514-AL-32	TEEJET SLOT.STR,AL.	1.97	451BEC-2NQ-P	450N MANIFOLD	442.46
4514-NY-10	#10 GENTIAN BLUE TEEJET SLOT. STR,NYLON	1.93	451BEC-2Q-C	450 MANIFOLD	472.72
4514-NY-20	#20 FLAME RED TEEJET SLOT. STR,NYLON	1.93	451BEC-2Q-CJ	450 MANIFOLD	483.77
4514-NY-32	#32 BROWN RED TEEJET SLOT. STR,NYLON	1.93	451BEC-2Q-COB	450 MANIFOLD	494.61
451BE-2NFS-CGC	450N MANIFOLD SS BALL	617.28	451BEC-2Q-COC	450 MANIFOLD	494.61
451BE-3FBQS-COB	450 FLOWBACK MNFD	676.82	451BEC-2Q-CVX	450 Manifold	494.61
451BEC-23-C	450 MANIFOLD	472.72	451BEC-2Q-D	450 MANIFOLD	472.72
451BEC-23-C03OG	450 MANIFOLD 3/4"	494.61	451BEC-2Q-P	450 MANIFOLD	451.31
451BEC-23-COB	450 MANIFOLD 3/4"	494.61	451BEC-3FB3-C	450 FLOWBACK MNFD	519.93
451BEC-23-CVX	450 MANIFOLD	494.61	451BEC-3FB3-C15	450 FLOWBACK MNFD	534.33
451BEC-23S-C	450 MANIFOLD SS	595.30	451BEC-3FB4-C	450 FLOWBACK MNFD	519.93
451BEC-23S-C15PB	450 MANIFOLD SS	631.66	451BEC-3FB4-COC	450 FLOWBACK MNFD	541.95
451BEC-23S-CK	450 MANIFOLD SS	606.30	451BEC-3FB4-CVX	450 FLOWBACK MNFD	541.95
451BEC-24-C	450 MANIFOLD	472.72	451BEC-3FB4S-C	450 FLOWBACK MNFD	654.80
451BEC-24-C15	MANIFOLD BALL VALVE	487.07	451BEC-3FBF-C	450 FLOWBACK MNFD	519.93
451BEC-24-C15TU	450 MANIFOLD	509.08	451BEC-3FBF-C15	450 FLOWBACK MNFD	534.33
451BEC-24-COB	450 MANIFOLD	494.61	451BEC-3FBF-C60VX	450 FLOWBACK MNFD	594.98
451BEC-24-COC	BALL VALVE ASSEMBLY	494.61	451BEC-3FBF-COC	450 FLOWBACK MNFD	541.95
451BEC-24-COG	450 MANIFOLD	494.61	451BEC-3FBF-CPG	450 FLOWBACK MNFD	541.95
451BEC-24-CPB	450 MANIFOLD	494.61	451BEC-3FBF-CVR	450 FLOWBACK MNFLD	541.95
451BEC-24-CPG	450 MANIFOLD 1"	494.61	451BEC-3FBF-CVX	450 FLOWBACK MNFLD	541.95
451BEC-24-CUX	451 MANIFOLD	494.61	451BEC-3FBF-CWR	450 FLOWBACK MNFD	541.95
451BEC-24-CVX	450 MANIFOLD	494.61	451BEC-3FBF-D	450 FLOWBACK MNFD	519.93
451BEC-24-D	450 MANIFOLD	472.72	451BEC-3FBFS-C	450 FLOWBACK MNFD	654.80
451BEC-24S-C	450 MANIFOLD SS	595.30	451BEC-3FBFS-CVR	450 FLOWBACK MANIFOLD	676.83
451BEC-24S-CVX	450 MANIFOLD SS 1"	617.28	451BEC-3FBFS-CVX	450 FLOWBACK MNFLD	676.83
451BEC-2F-C	450 MANIFOLD	472.72	451BEC-3FBQ-C	450 FLOWBACK MNFD	519.93
451BEC-2F-C03PG	450 MANIFOLD	494.61	451BEC-3FBQ-C15	450 FLOWBACK MNFD	534.33
451BEC-2F-C15	450 MANIFOLD	487.07	451BEC-3FBQ-C60	450 MANIFOLD	611.18
451BEC-2F-C15OB	450 MANIFOLD	509.02	451BEC-3FBQ-COB	450 MANIFOLD	541.95
451BEC-2F-C15VX	450 MANIFOLD	509.02	451BEC-3FBQ-COC	450 FLOWBACK MANIFOLD	541.95
451BEC-2F-C60	450 MANIFOLD	525.76	451BEC-3FBQ-D	450 FLOWBACK MNFD	519.93
451BEC-2F-COB	450 MANIFOLD	494.61	45222-AMP-F	CONNECTOR SUB ASB	22.07
451BEC-2F-COC	450 MANIFOLD	494.61	45222-AMP-M	CONNECTOR SUB ASSBLY	22.07
451BEC-2F-CPC	450 MANIFOLD	494.61	45222-DEU-F	CONNECTOR SUB ASBLY	22.07
451BEC-2F-CPG	450 MANIFOLD	494.61	45222-DEU-M	CONNECTOR SUB ASBLY	22.07
451BEC-2F-CPU	450 MANIFOLD	494.61	45222-FAS-F	CONNECTOR SUB ASBLY	11.12
451BEC-2F-CUX	450 MANIFOLD	494.61	45222-FAS-M	CONNECTOR SUB ASBLY	11.12
451BEC-2F-CVX	450 MANIFOLD	494.61	45222-JST-F	CONNECTOR SUB ASBLY	22.07
451BEC-2F-D	450 MANIFOLD	472.72	45222-PEW-F	CONNECTOR SUB ASBLY	22.07
451BEC-2F-P	450 MANIFOLD LESS CABLE	451.31	45222-PEW-M	CONNECTOR SUB ASBLY	22.07
451BEC-2FS-C	450 MANIFOLD SS	595.30	45223-AMP-F	CONNECTOR SUB ASBLY	22.07
451BEC-2FS-C03PB	450 MANIFOLD SS	617.28	45223-AMP-M	CONNECTOR SUB ASBLY	22.07
451BEC-2FS-C15PB	450 MANIFOLD SS	631.62	45223-DEU-F	CONNECTOR SUB ASBLY	22.07
451BEC-2FS-CVX	450 MANIFOLD SS	617.28	45223-DEU-M	CONNECTOR SUB ASBLY	22.07
451BEC-2FS-CWX	450 MANIFOLD SS	617.28	45223-FAS-F	CONNECTOR SUB ASBLY	11.12
451BEC-2N4-C	450N MANIFOLD	472.72	45223-FAS-M	CONNECTOR SUB ASBLY	11.12
451BEC-2N4-C15	450N MANIFOLD	487.07	45223-JST-F	CONNECTOR SUB ASBLY	22.07
451BEC-2N4-COC	450N MANIFOLD	494.61	45223-PEM-M	CONNECTOR SUB ASBLY	22.07
451BEC-2NF-C	450N MANIFOLD	472.72	45223-PEW-F	CONNECTOR SUB ASBLY	22.07
451BEC-2NF-COC	450N MANIFOLD	494.61	45223-PEW-M	CONNECTOR SUB ASBLY	22.07
451BEC-2NF-CVR	450N MANIFOLD	494.61	45224-PEW-F	TOWER CONNECTOR	22.07
451BEC-2NF-CVX	450N MANIFOLD	494.61	45224-PEW-M	SHROUD CONNECTOR	22.07
451BEC-2NFS-C	450N MANIFOLD SS	595.31	452BE-2NFS-CGC	450N MANIFOLD SS BALL	1251.64
451BEC-2NFS-CVX	450 MANIFOLD SS	617.28	452BEC-23-C	450 MANIFOLD	974.97
451BEC-2NFS-CWX	450N MANIFOLD SS	617.28	452BEC-23-C60	450 MANIFOLD	1081.02
451BEC-2NFS-P	450N MANIFOLD SS	573.92	452BEC-23-CSC	450 MANIFOLD	1018.90
451BEC-2NQ-C	450 MANIFOLD	472.72	452BEC-23S-C	450 MANIFOLD	1220.22
451BEC-2NQ-C60	450N MANIFOLD	563.98	452BEC-24-C	450 MANIFOLD	974.97
			452BEC-24-C15	450 MANIFOLD	1003.72
			452BEC-24-C15VX	450 MANIFOLD	1047.72
			452BEC-24-COC	450 MANIFOLD	1018.90

PART NO.	DESCRIPTION	U.S.DOLLARS	PART NO.	DESCRIPTION	U.S.DOLLARS
452BEC-24-CPG	450 MANIFOLD	1018.90	453BEC-23-C15	450 MANIFOLD	1520.25
452BEC-24-CUX	450 MANIFOLD	1018.90	453BEC-23-C60	450 MANIFOLD	1636.25
452BEC-24S-C	450 MANIFOLD	1220.22	453BEC-23-CK	450 MANIFOLD	1488.00
452BEC-24S-CUX	450 MANIFOLD	1264.25	453BEC-23-COB	450 MANIFOLD	1542.93
452BEC-2F-C	450 MANIFOLD	974.97	453BEC-23-CVJ	450 MANIFOLD	1542.93
452BEC-2F-C03PG	450 MANIFOLD	1018.90	453BEC-23-CVX	450 MANIFOLD	1542.93
452BEC-2F-C15	452 MANIFOLD	1003.72	453BEC-23S-C	450 MANIFOLD	1844.96
452BEC-2F-CN15	450 MANIFOLD	1003.72	453BEC-23S-C60	450 MANIFOLD	2004.11
452BEC-2F-COB	450 MANIFOLD	1018.90	453BEC-23S-C60J	450 MANIFOLD	2037.14
452BEC-2F-COC	450 MANIFOLD	1018.90	453BEC-24-C	450 MANIFOLD	1477.14
452BEC-2F-COG	450 MANIFOLD	1018.90	453BEC-24-C03OG	450 MANIFOLD	1542.93
452BEC-2F-CPG	450 MANIFOLD	1018.90	453BEC-24-C03VX	450 MANIFOLD	1542.93
452BEC-2F-CVX	450 MANIFOLD	1018.90	453BEC-24-C15	450 MANIFOLD	1520.25
452BEC-2F-P	450 MANIFOLD LESS CABLE	1017.78	453BEC-24-C15VX	450 MANIFOLD	1586.00
452BEC-2FS-C	450 MANIFOLD	1220.22	453BEC-24-C60	450 MANIFOLD	1636.25
452BEC-2FS-C15	450 MANIFOLD	1248.95	453BEC-24-CK	450 MANIFOLD	1510.14
452BEC-2FS-CN	450 MANIFOLD	1220.22	453BEC-24-COB	450 MANIFOLD	1542.93
452BEC-2FS-CVX	450 MANIFOLD SS	1264.25	453BEC-24-COC	450 MANIFOLD	1542.93
452BEC-2N3-C	450N MANIFOLD	974.97	453BEC-24-CPG	450 MANIFOLD	1542.93
452BEC-2N3-CVX	450N MANIFOLD	1018.90	453BEC-24-CVX	450 MANIFOLD	1542.93
452BEC-2N3S-C	450N MANIFOLD	1220.17	453BEC-24-P	450 MANIFOLD LESS CABLE	1412.94
452BEC-2N4-C	450N MANIFOLD	974.97	453BEC-24S-C	450 MANIFOLD	1844.96
452BEC-2N4-C15	450N MANIFOLD	1003.72	453BEC-24S-C60	450 MANIFOLD	1896.96
452BEC-2N4-CVX	450N MANIFOLD	1018.90	453BEC-24S-CK	450 MANIFOLD	1877.95
452BEC-2NF-C	450N MANIFOLD	974.97	453BEC-24S-COC	450 MANIFOLD	1910.78
452BEC-2NF-C60VX	450N MANIFOLD	1125.08	453BEC-24S-CVX	450 MANIFOLD	1910.78
452BEC-2NF-COB	450N MANIFOLD	1018.90	453BEC-2F-C	450 MANIFOLD	1477.14
452BEC-2NF-COC	450N MANIFOLD	909.73	453BEC-2F-C03OG	450 MANIFOLD	1542.93
452BEC-2NFS-C	450N MANIFOLD	1220.17	453BEC-2F-C03PG	450 MANIFOLD	1542.93
452BEC-2NFS-CPG	450N MANIFOLD	1264.18	453BEC-2F-C15	450 MANIFOLD	1520.25
452BEC-2NQ-COB	450N MANIFOLD	1018.90	453BEC-2F-C15VX	450 MANIFOLD	1586.07
452BEC-2NQ-D	450N MANIFOLD	974.97	453BEC-2F-CN15	450 MANIFOLD	1520.25
452BEC-2Q-C	450 MANIFOLD	974.97	453BEC-2F-COC	450 MANIFOLD	1542.93
452BEC-2Q-CUX	450 BEC MANIFOLD	1018.90	453BEC-2F-CPB	450 MANIFOLD	1542.93
452BEC-2Q-CVX	450 MANIFOLD	1018.90	453BEC-2F-CPU	450 MANIFOLD	1542.93
452BEC-2Q-D	450 MANIFOLD	974.97	453BEC-2F-CSC	450 MANIFOLD	1542.93
452BEC-3FB3-C	450 FLOWBACK MNFD	1072.47	453BEC-2F-CVX	450 MANIFOLD	1542.93
452BEC-3FB4-C	450 FLOWBACK MNFD	1072.47	453BEC-2F-D	450 MANIFOLD	1477.14
452BEC-3FB4-COC	450 FLOWBACK MNFD	1116.44	453BEC-2F-P	450 MANIFOLD LESS CABLE	1412.94
452BEC-3FB4-CVX	450 FLOWBACK MNFD	1116.44	453BEC-2FS-C	450 MANIFOLD	1844.96
452BEC-3FB4S-C	450 FLOWBACK MNFD	1342.21	453BEC-2FS-CPU	450 MANIFOLD SS BALL	1866.97
452BEC-3FBF-C	450 FLOWBACK MNFD	1072.47	453BEC-2FS-CSC	450 MANIFOLD SS BALL	1866.97
452BEC-3FBF-C15	450 FLOWBACK MNFD	1079.63	453BEC-2FS-CVX	450 MANIFOLD	1866.97
452BEC-3FBF-COC	450 FLOWBACK MNFD	1116.44	453BEC-2N3-CVX	450N MANIFOLD	1542.93
452BEC-3FBF-CPG	450 MANIFOLD	1116.44	453BEC-2N4-C	450N MANIFOLD	1477.14
452BEC-3FBF-CVR	450 FLOWBACK MNFD	1116.44	453BEC-2N4-C15	450N MANIFOLD	1520.25
452BEC-3FBF-CVX	450 FLOWBACK MNFD	1116.44	453BEC-2N4-COC	450N MANIFOLD	1542.93
452BEC-3FBF-P	TRIPLE HOSE SHANK,NY	1029.69	453BEC-2N4-CVX	450N MANIFOLD	1542.93
452BEC-3FBFS-C	450 FLOWBACK MNFD	1342.21	453BEC-2N4S-CVX	450N MANIFOLD	1866.97
452BEC-3FBQ-C	450 FLOWBACK MNFD	1072.47	453BEC-2NF-C	450N MANIFOLD	1477.14
452BEC-3FBQ-C15	450 FLOWBACK MNFD	1101.24	453BEC-2NF-COB	450 MANIFOLD	1542.93
452BEC-3FBQ-COC	450 FLOWBACK MNFD	1116.44	453BEC-2NF-COC	450 MANIFOLD	1542.93
452BEC-3FBQS-CVX	450 FLOWBACK MNFD SS	1386.19	453BEC-2NF-CPB	450 MANIFOLD	1542.93
453BE-24-C	450 MANIFOLD	1477.14	453BEC-2NF-CQB	450 MANIFOLD	1542.93
453BE-2F-C	453 VALVE MANIFOLD	1477.14	453BEC-2NF-CQC	450 MANIFOLD	1542.93
453BE-2N3-C	450N MANIFOLD	1477.14	453BEC-2NF-CVX	450 MANIFOLD	1542.93
453BE-2N4-C	450N MANIFOLD	1477.14	453BEC-2NFS-C	450N MANIFOLD	1844.96
453BE-2NF-COB	450N MANIFOLD	1477.14	453BEC-2NFS-C15	450 MANIFOLD	1888.07
453BE-2Q-C	450 MANIFOLD	1477.14	453BEC-2NFS-CPB	450N MANIFOLD SS BALL	1866.97
453BE-3FB3-CPS	450 FLOWBACK MNFD	1697.20	453BEC-2NFS-CSC	450N MANIFOLD SS BALL	1866.97
453BE-3FB4-CVX	450 FLOWBACK MNFD	1697.20	453BEC-2NFS-CWX	450N MANIFOLD SS BALL	1866.97
453BE-3FBF-COB	450 FLOWBACK MNFD	1697.20	453BEC-2NQ-COB	450 MANIFOLD	1542.93
453BEC-23-C	450 MANIFOLD	1477.14	453BEC-2NQ-COC	450 MANIFOLD	1542.93
453BEC-23-C03OG	450 MANIFOLD	1542.93	453BEC-2Q-C	450 MANIFOLD	1477.14

PART NO.	DESCRIPTION	U.S.DOLLARS	PART NO.	DESCRIPTION	U.S.DOLLARS
453BEC-2Q-CJ	450 MANIFOLD	1510.14	454BEC-2F-P	450 MANIFOLD LESS CABLE 530	1871.97
453BEC-2Q-CK	450 MANIFOLD	1510.14	454BEC-2FS-C	450 MANIFOLD	2469.82
453BEC-2Q-COB	450 MANIFOLD	1542.93	454BEC-2FS-C60	450 MANIFOLD SS	2660.16
453BEC-2Q-COC	450 MANIFOLD	1542.93	454BEC-2FS-CVX	450 MANIFOLD	2535.75
453BEC-2Q-CPB	450 MANIFOLD	1542.93	454BEC-2N3-C	450N MANIFOLD	1957.58
453BEC-2Q-P	450 MANIFOLD	1412.93	454BEC-2N4-C	450N MANIFOLD	1957.58
453BEC-3FB3-C	450 FLOWBACK MNFD	1624.83	454BEC-2N4-COC	450N MANIFOLD	2045.33
453BEC-3FB3-C15	450 FLOWBACK MNFD	1667.99	454BEC-2N4-CVX	450N MANIFOLD	2032.22
453BEC-3FB3-CVX	450 FLOWBACK MNFD	1697.20	454BEC-2NF-C	450N MANIFOLD	1957.58
453BEC-3FB3-P	450 FLOWBACK MNFD LESS CABLE	1560.61	454BEC-2NF-COG	450N MANIFOLD	2045.33
453BEC-3FB4-C	450 FLOWBACK MNFD	1624.83	454BEC-2NF-CPU	450N MANIFOLD	2045.33
453BEC-3FB4-C15	450 FLOWBACK MNFD	1669.37	454BEC-2NF-CVX	450N MANIFOLD	2045.33
453BEC-3FB4-COC	450 FLOWBACK MNFD	1697.20	454BEC-2NQ-COB	450N MANIFOLD	2045.33
453BEC-3FB4-CPC	450 FLOWBACK MNFD	1697.20	454BEC-2NQ-COC	450N MANIFOLD	2045.33
453BEC-3FB4-CVX	450 FLOWBACK MNFD	1697.20	454BEC-2NQ-CPG	450N MANIFOLD	2045.33
453BEC-3FB4-P	450 FLOWBACK MNFD LESS CABLE	1560.61	454BEC-2NQ-CVX	450N MANIFOLD	2045.33
453BEC-3FB4S-C	450 FLOWBACK MNFD	2029.45	454BEC-2NQ-D	450N MANIFOLD	1957.58
453BEC-3FBF-C	450 FLOWBACK MNFD	1624.83	454BEC-2Q-C	450 MANIFOLD	1957.58
453BEC-3FBF-C15	450 FLOWBACK MNFD	1667.99	454BEC-2Q-COB	450 MANIFOLD	2045.33
453BEC-3FBF-CJ	450 FLOWBACK MNFD	1657.93	454BEC-2Q-COC	450 MANIFOLD	2045.33
453BEC-3FBF-COB	450 FLOWBACK MNFD	1697.20	454BEC-2Q-CVX	450 MANIFOLD	2045.33
453BEC-3FBF-COC	450 FLOWBACK MNFD	1697.20	454BEC-2Q-D	450 MANIFOLD	1957.58
453BEC-3FBF-CVX	450 FLOWBACK MNFD	1697.20	454BEC-3FB3-C	450 FLOWBACK MNFD	2153.29
453BEC-3FBF-CWR	450 FLOWBACK MNFD	1697.20	454BEC-3FB4-C	450 FLOWBACK MNFD	2153.29
453BEC-3FBF-D	450 FLOWBACK MNFD	1624.83	454BEC-3FB4-C15	450 FLOWBACK MNFD	2210.88
453BEC-3FBF-P	450 FLOWBACK MNFD	1560.61	454BEC-3FB4-COC	450 FLOWBACK MNFD	2241.27
453BEC-3FBFS-C	450 FLOWBACK MNFD	2029.45	454BEC-3FB4S-C	450 FLOWBACK MNFD	2716.80
453BEC-3FBFS-COC	450 FLOWBACK MNFD	2050.42	454BEC-3FBF-C	450 FLOWBACK MNFD	2153.29
453BEC-3FBQ-C	450 FLOWBACK MNFD	1624.83	454BEC-3FBF-C15	450 FLOWBACK MNFD	2210.88
453BEC-3FBQ-C15	450 FLOWBACK MNFD	1667.99	454BEC-3FBF-COB	450 FLOWBACK MNFD	2241.27
453BEC-3FBQ-CJ	450 MANIFOLD	1657.93	454BEC-3FBF-COC	450 FLOWBACK MNFD	2241.27
453BEC-3FBQ-CN	450 MANIFOLD	1624.83	454BEC-3FBF-CPU	450 FLOWBACK MNFD	2241.27
453BEC-3FBQ-COC	450 MANIFOLD	1697.20	454BEC-3FBF-CVX	450 FLOWBACK MNFD	2241.27
453BEC-3FBQ-D	450 FLOWBACK MNFD	1624.83	454BEC-3FBF-D	450 FLOWBACK MNFD	2153.29
454BE-24S-C	BALL VALVE ASSEMBLY	2469.82	454BEC-3FBQ-C	450 FLOWBACK MNFD	2153.29
454BE-2Q-D	450 MANIFOLD	1957.58	454BEC-3FBQ-C60	450 FLOWBACK MNFD	2365.42
454BE-2QS-D	450 MANIFOLD SS	2447.98	454BEC-3FBQ-COC	450 FLOWBACK MNFD	2241.30
454BEC-23-C	450 MANIFOLD	1957.58	454BEC-3FBQ-D	450 FLOWBACK MNFD	2153.29
454BEC-23-C03OG	450 MANIFOLD	2045.33	45519-15	1.5M DIN CON/JST ASB	99.47
454BEC-23-C15	450 MANIFOLD	2015.06	45519-30	3M DIN/JST CON ASB	99.47
454BEC-23-CJ	450 MANIFOLD	2001.78	45519-60	6M DIN CON/JST ASB	99.47
454BEC-23-COC	450 MANIFOLD	2045.33	45528-1-VI	1 VALVE ASBLY KIT	50.40
454BEC-23-CVX	450 MANIFOLD	2045.33	45528-2-VI	2 VALVE ASBLY KIT	75.46
454BEC-23S-C60	450 MANIFOLD	2660.16	45528-3-VI	3 VALVE ASBLY KIT	100.56
454BEC-24-C	450 MANIFOLD	1957.58	45528-4-VI	4 VALVE ASBLY KIT	125.70
454BEC-24-C03OG	450 MANIFOLD	2045.33	45528-5-VI	5 VALVE ASBLY KIT	150.78
454BEC-24-C15	450 MANIFOLD	2015.06	45528-6-VI	6 VALVE ASBLY KIT	175.96
454BEC-24-COB	450 MANIFOLD	2045.33	45528-7-VI	7 VALVE ASBLY KIT	201.05
454BEC-24-COC	450 MANIFOLD	2045.33	45528-8-VI	8 VALVE ASBLY KIT	226.16
454BEC-24-CPB	450 MANIFOLD	2045.33	45528-9-VI	9 VALVE ASBLY KIT	251.29
454BEC-24-CPG	450 MANIFOLD	2045.33	45529-1	1" HOSEBARB OUTLET	12.94
454BEC-24S-C	450 MANIFOLD	2469.82	45529-1/2	1/2 HOSEBARB OUTLET	12.94
454BEC-24S-CVX	450 MANIFOLD	2535.75	45529-1M	1 HB OUTLET X M QC	12.94
454BEC-2F-C	450 MANIFOLD	1957.58	45529-3/4	3/4 HOSEBARB OUTLET	12.94
454BEC-2F-C15	450 MANIFOLD	2015.06	45529-3/4M	3/4 HB OUTLET X M QC	12.94
454BEC-2F-C15OC	450 MANIFOLD	2102.81	45529-3/8	3/8 HOSEBARB OUTLET	12.94
454BEC-2F-C60	450 MANIFOLD	2169.73	45529-5/8	5/8 HOSEBARB OUTLET	12.94
454BEC-2F-COB	450 MANIFOLD	2045.33	45529-90-1	1"90 HOSEBARB OUTLET	12.94
454BEC-2F-COC	450 MANIFOLD	2045.33	45529-90-1-1/4	1 1/4X90 HB OUTLET	12.94
454BEC-2F-CPB	450 MANIFOLD	2045.33	45529-90-1/2	1/2X90 HB OUTLET	12.94
454BEC-2F-CVX	450 MANIFOLD	2045.33	45529-90-3/4	3/4X90 HB OUTLET	12.94
454BEC-2F-D	450 MANIFOLD	1957.58	45529-90-5/8	5/8X90 HB OUTLET	12.94
			45529-C	QUICK CONNECT CAP S/ASB	12.94
			45529-P	QUICK CONNECT PLUG S/ASB	12.94

PART NO.	DESCRIPTION	U.S.DOLLARS	PART NO.	DESCRIPTION	U.S.DOLLARS
45529-PTC-4-3/8	4 X 3/8 PTC QC OUTLET	59.35	455BEC-2NF-CVX	450 MANIFOLD	2411.28
45529-QT	QUICK TEEJET OUTLET	12.94	455BEC-2NFS-C	450 MANIFOLD	3094.47
455BE-24-C	450 MANIFOLD	2437.90	455BEC-2NFS-CVX	450 MANIFOLD SS	3032.68
455BE-24-COB	450 MANIFOLD	2459.85	455BEC-2NFS-CWX	450 MANIFOLD	3204.34
455BE-24-COC	450 MANIFOLD	2547.77	455BEC-2NQ-COB	450N MANIFOLD	2547.77
455BE-2F-C	450 MANIFOLD	2437.90	455BEC-2NQ-COC	450N MANIFOLD	2547.77
455BE-2NF-C15	450 MANIFOLD	2509.73	455BEC-2NQ-CVX	450N MANIFOLD	2547.77
455BE-3FB3-COB	450 FLOWBACK MNFLD	2669.08	455BEC-2NQS-COB	450 MANIFOLD	3204.34
455BE-3FBF-COB	450 FLOWBACK MNFD	2802.56	455BEC-2Q-C	450 MANIFOLD	2437.90
455BE-3FBF-COG	450 FLOWBACK MNFD	2802.56	455BEC-2Q-COB	450 MANIFOLD	2547.77
455BE-3FBQ-D	450 FLOWBACK MNFD	2681.70	455BEC-2Q-COC	450 MANIFOLD	2547.77
455BE-3FBQS-COB	450 FLOWBACK MNFD	3514.08	455BEC-2Q-CVX	450 MANIFOLD	2547.77
455BEC-23-C	450 MANIFOLD	2437.90	455BEC-2Q-D	450 MANIFOLD	2437.90
455BEC-23-C03OG	450 MANIFOLD	2547.77	455BEC-3FB3-C15	450 FLOWBACK MNFD	2753.58
455BEC-23-C15	450 MANIFOLD	2703.05	455BEC-3FB3-COB	450 FLOWBACK MNFD	2802.56
455BEC-23-C15VX	450 MANIFOLD	2812.92	455BEC-3FB3-CVX	450 FLOWBACK MNFD	2802.56
455BEC-23-C60VX	450 MANIFOLD	2812.87	455BEC-3FB3-D	450 FLOWBACK MNFD	2681.70
455BEC-23S-C	450 MANIFOLD	3094.67	455BEC-3FB4-C	450 FLOWBACK MNFD	2681.70
455BEC-24-C	450 MANIFOLD	2437.90	455BEC-3FB4-C15	450 FLOWBACK MNFD	2753.58
455BEC-24-C15	450 MANIFOLD	2509.73	455BEC-3FB4-COC	450 FLOWBACK MNFD	2802.56
455BEC-24-C60	450 MANIFOLD	2703.05	455BEC-3FB4-CVX	450 FLOWBACK MNFD	2802.56
455BEC-24-CJ	450 MANIFOLD	2493.13	455BEC-3FB4S-C	450 FLOWBACK MNFD	3404.15
455BEC-24-COB	450 MANIFOLD	2547.77	455BEC-3FB4S-C15TU	450 FLOWBACK MNFD	3586.06
455BEC-24-COC	450 MANIFOLD 1"	2547.77	455BEC-3FBF-C	450 FLOWBACK MNFD	2681.70
455BEC-24-COS	450 MANIFOLD	2547.77	455BEC-3FBF-C15	450 FLOWBACK MNFD	2753.58
455BEC-24-CPK	450 MANIFOLD	2547.77	455BEC-3FBF-C60VX	450 FLOWBACK MNFD	3067.68
455BEC-24-CVX	450 MANIFOLD	2547.77	455BEC-3FBF-CJ	450 FLOWBACK MNFD	2736.84
455BEC-24-P	450 MANIFOLD	2285.19	455BEC-3FBF-CN15	450 FLOWBACK MNFD	2753.58
455BEC-24S-C	450 MANIFOLD	3094.67	455BEC-3FBF-COB	450 FLOWBACK MNFD	2802.56
455BEC-24S-C15	450 MANIFOLD	3166.58	455BEC-3FBF-COC	450 FLOWBACK MNFD	2802.56
455BEC-24S-CO3	450 MANIFOLD	3094.67	455BEC-3FBF-CPG	450 FLOWBACK MNFD	2802.56
455BEC-24S-COC	450 MANIFOLD	3204.34	455BEC-3FBF-CPK	450 FLOWBACK MNFD	2802.56
455BEC-24S-CUA	450 MANIFOLD	3204.34	455BEC-3FBF-CVR	450 FLOWBACK MNFD	2802.56
455BEC-24S-CVA	450 MANIFOLD	3204.34	455BEC-3FBF-CVX	450 FLOWBACK MNFD	2802.56
455BEC-24S-CVX	450 MANIFOLD	3204.34	455BEC-3FBF-CWR	450 FLOWBACK MNFD	2802.56
455BEC-2F-C	450 MANIFOLD	2437.90	455BEC-3FBF-D	450 FLOWBACK MNFD	2681.70
455BEC-2F-C15	450 MANIFOLD	2509.73	455BEC-3FBFS-C	450 FLOWBACK MNFD	3404.15
455BEC-2F-C15OC	450 MANIFOLD	2619.60	455BEC-3FBFS-COB	450 FLOWBACK MNFD	3514.13
455BEC-2F-C60TU	450 MANIFOLD	2812.87	455BEC-3FBFS-COC	450 FLOWBACK MNFD	3514.13
455BEC-2F-CN15	450 MANIFOLD	2509.73	455BEC-3FBFS-COK	450 FLOWBACK MNFD	2802.56
455BEC-2F-COB	450 MANIFOLD	2547.77	455BEC-3FBFS-CPG	450 FLOWBACK MNFD	3514.08
455BEC-2F-COC	450 MANIFOLD FLANGE	2547.77	455BEC-3FBFS-CVR	450 FLOWBACK MNFD	3514.13
455BEC-2F-COG	450 MANIFOLD	2547.77	455BEC-3FBQ-C15	450 FLOWBACK MNFD	2753.58
455BEC-2F-COU	450 MANIFOLD	2547.77	455BEC-3FBQ-C60	450 FLOWBACK MNFD	2946.91
455BEC-2F-CPC	450 MANIFOLD	2547.77	455BEC-3FBQ-COB	450 FLOWBACK MNFD	2802.56
455BEC-2F-CPG	450 MANIFOLD	2547.77	455BEC-3FBQ-COC	450 FLOWBACK MNFD	2802.56
455BEC-2F-CVX	450 MANIFOLD	2547.77	455BEC-3FBQ-CPK	450 FLOWBACK MNFD	2802.56
455BEC-2F-D	450 MANIFOLD	2437.90	455BEC-3FBQ-CVX	450 FLOWBACK MNFD	2802.56
455BEC-2FS-C	450 MANIFOLD	3094.67	455BEC-3FBQ-D	450 FLOWBACK MNFD	2681.70
455BEC-2FS-COB	450 MANIFOLD	3204.34	455BEC-3FBQS-COB	450 FLOWBACK MNFD	3525.03
455BEC-2FS-CVR	450 MANIFOLD	3204.34	456BEC-23-C	450 MANIFOLD	2855.50
455BEC-2N3-C	450N MANIFOLD	2437.90	456BEC-23S-C	450 MANIFOLD	3591.18
455BEC-2N3-CVX	450N MANIFOLD	2547.77	456BEC-2F-C	450 MANIFOLD	2855.50
455BEC-2N4-C	450N MANIFOLD	2437.90	456BEC-2F-COC	450 MANIFOLD	2986.97
455BEC-2N4-C15	450 MANIFOLD	2509.73	456BEC-2F-CVX	450 MANIFOLD	2986.97
455BEC-2N4-CJ	450 MANIFOLD	2493.08	456BEC-2N4-CVX	450 MANIFOLD	2986.97
455BEC-2N4-COC	450 MANIFOLD	2624.22	456BEC-2NFS-C	450 MANIFOLD	3591.18
455BEC-2N4-CVX	450 MANIFOLD	2547.77	456BEC-2NQ-COB	450 MANIFOLD	2986.97
455BEC-2NF-C	450N MANIFOLD	2437.90	456BEC-2Q-C	450 MANIFOLD	2855.50
455BEC-2NF-COC	450 MANIFOLD	2547.77	456BEC-3FB4-C	450 FLOWBACK MNFD	3231.20
455BEC-2NF-CPG	450 MANIFOLD	2547.77	456BEC-3FB4-COC	450 FLOWBACK MNFD	3362.97
455BEC-2NF-CQB	450 MANIFOLD	2547.77	456BEC-3FBF-C	450 FLOWBACK MNFD	3231.20
455BEC-2NF-CTU	450N MANIFOLD	2547.77	456BEC-3FBF-COC	450 FLOWBACK MNFD	3362.97
455BEC-2NF-CVR	450 MANIFOLD	2547.77	456BEC-3FBF-CPG	450 FLOWBACK MNFD	3362.97



PART NO.	DESCRIPTION	U.S.DOLLARS	PART NO.	DESCRIPTION	U.S.DOLLARS
456BEC-3FBFS-COB	450 FLOWBACK MNFD	4244.42	461BEC-24-C15	460 MANIFOLD	574.24
456BEC-3FBFS-CVX	450 FLOWBACK MNFD SS	4244.42	461BEC-24-C60	460 MANIFOLD	618.66
456BEC-3FBQ-COC	450 FLOWBACK MNFD	3362.97	461BEC-24-C60TU	460 MANIFOLD	640.63
457BE-24-C	450 MANIFOLD	3410.42	461BEC-24-CPB	460 MANIFOLD	581.72
457BE-2F-C	450 MANIFOLD	3410.42	461BEC-24-CVX	460 MANIFOLD	587.52
457BEC-23-C	450 MANIFOLD	3410.42	461BEC-24-D	460 MANIFOLD	565.63
457BEC-23S-C	450 MANIFOLD	4758.74	461BEC-2F-C	460 MANIFOLD	565.63
457BEC-24-COC	450 MANIFOLD	3564.38	461BEC-2F-COB	460 MANIFOLD	587.52
457BEC-2F-COC	450 MANIFOLD	3564.38	461BEC-2F-COC	460 MANIFOLD	587.52
457BEC-2FS-C	450 MANIFOLD	4758.74	461BEC-2F-CVX	460 MANIFOLD	587.52
457BEC-2N3-CVX	450 MANIFOLD	3564.38	461BEC-2F-D	460 MANIFOLD	565.63
457BEC-2N3-P	450 MANIFOLD	3228.30	461BEC-2Q-C	460MANIFOLD	565.63
457BEC-2N4-C	450 MANIFOLD	3410.42	461BEC-2Q-C15	460 MANIFOLD	580.01
457BEC-2N4-CVX	450 MANIFOLD	3564.38	461BEC-2Q-C15TU	460 MANIFOLD	587.52
457BEC-2NF-COC	450 MANIFOLD	3564.38	461BEC-2Q-CJ	460 MANIFOLD	576.61
457BEC-2NF-CQB	450 MANIFOLD	3564.38	461BEC-2Q-COB	460 MANIFOLD	587.52
457BEC-2NF-CVX	450 MANIFOLD	3564.38	461BEC-2Q-COC	460 MANIFOLD	587.52
457BEC-2NFS-CWX	450 MANIFOLD	4912.70	461BEC-2Q-CVX	460 MANIFOLD	587.52
457BEC-2NQ-COB	450 MANIFOLD	3564.38	461BEC-2Q-D	460MANIFOLD	565.63
457BEC-2NQ-D	450 MANIFOLD	3410.42	461BEC-2Q-DN	460 MANIFOLD	565.63
457BEC-3FB3-CVX	450 FLOWBACK MNFD	3923.50	461BEC-3C4-C	460 SHUTOFF/BYPASS	810.06
457BEC-3FB3S-COC	450 FLOWBACK MNFD	4963.96	461BEC-3C4-CK	460 SHUTOFF/BYPASS	832.04
457BEC-3FB4-C	450 FLOWBACK MNFD	3769.54	461BEC-3CF-C	460 SHUTOFF/BYPASS	810.06
457BEC-3FBF-C	450 FLOWBACK MNFD	3769.54	461BEC-3CF-C15	460 SHUTOFF/BYPASS	873.40
457BEC-3FBF-COB	450 FLOWBACK MNFD	3923.50	461BEC-3CF-COC	460 SHUTOFF/BYPASS	832.04
457BEC-3FBF-COC	450 FLOWBACK MNFD	3923.50	461BEC-3CF-D	460 SHUTOFF/BYPASS	810.06
457BEC-3FBFS-COC	450 FLOWBACK MNFD	4963.96	461BEC-3CQ-C	SHUTOFF/BYPASS QC	810.06
457BEC-3FBQ-COB	450 FLOWBACK MNFD	3923.50	461BEC-3CQ-CN15RB	BYPASS/SHUTOFF QC	855.31
457BEC-3FBQ-CVX	450 FLOWBACK MNFD	3923.50	461BEC-3CQ-D	SHUTOFF/BYPASS QC	810.06
457BEC-3FBQ-D	450 FLOWBACK MNFD	3769.54	461BEC-3E4-C	460 MANIFOLD	917.07
458BEC-2NF-CVX	450 N MANIFOLD	4076.12	461BEC-3E4-CPB	460 MANIFOLD	939.00
458BEC-3FBF-C	450 FB MANIFOLD	4297.92	461BEC-3EF-C	460 SHUTOFF/BYPASS	917.07
459BEC-2N3-C	450 N MANIFOLD	4399.67	461BEC-3EF-C15	460 MANIFOLD	993.52
459BEC-2N3-CVX	450N MANIFOLD	4588.19	461BEC-3EF-D	460 MANIFOLD	917.07
459BEC-2N3-P	450 N MANIFOLD	4207.02	461BEC-3EQ-C	460 SHUTOFF/BYPASS QC	917.07
459BEC-2N3S-C	450 N MANIFOLD	5503.10	461BEC-3EQ-D	460 MANIFOLD	917.07
459BEC-2N3S-CVX	450 N MANIFOLD SS BALL	5691.63	461BEC-3FB3-C	460 FLOWBACK	976.61
459BEC-2N3S-P	450 N MANIFOLD	5310.47	461BEC-3FB3-CN15	460 FLOW BACK	990.96
459BEC-2N4-C15	450N MANIFOLD	4528.79	461BEC-3FB3-COB	460 FLOW BACK	998.56
459BEC-2N4-CVX	450N MANIFOLD	4588.19	461BEC-3FB4-C	460 FLOWBACK	976.61
459BEC-2NF-C	450 N MANIFOLD	4399.67	461BEC-3FBF-COC	460 MANIFOLD	998.56
459BEC-2NF-C60	450 N MANIFOLD	5220.88	461BEC-3FBF-D	460 MANIFOLD	976.61
459BEC-2NF-COC	450 N MANIFOLD	4588.19	461BEC-3FBQ-C60	460 FLOW BACK	1029.66
459BEC-2NF-CVR	450N MANIFOLD	4588.19	461BEC-3FBQ-CN15RB	460 FLOWBACK VALVE	1013.09
459BEC-2NF-CVX	450 N MANIFOLD	4588.19	461BEC-3FBQ-D	461 FB MANIFOLD	976.61
459BEC-2NQ-COB	450N MANIFOLD	4588.19	4629-3/4-TOC06	BOOMJET NOZZLE,BRASS	255.87
459BEC-2NQ-P	450N MANIFOLD LESS CABLE	4207.02	4629-3/4-TOC10	BOOMJET NOZZLE,BRASS	255.87
459BEC-3FBF-C	450 FLOWBACK MNFD	4847.34	4629-3/4-TOC150	BOOMJET NOZZLE,BRASS	255.87
459BEC-3FBF-COB	450 FLOWBACK MNFD	5044.45	4629-3/4-TOC20	BOOMJET NOZZLE,BRASS	255.87
459BEC-3FBF-COC	450 FLOWBACK MNFD	5044.45	4629-3/4-TOC30	BOOMJET NOZZLE BRASS	255.87
459BEC-3FBQ-COB	450 FLOWBACK MNFD	5044.45	4629-3/4-TOC300	BOOMJET NOZZLE,BRASS	255.87
459BEC-3FBQ-CVX	450 FLOWBACK MNFD	5044.45	4629-3/4-TOC40	BOOMJET NOZZLE,BRASS	255.87
459BEC-3FBQS-CVX	450 FLOWBACK MNFD	6258.34	4629-3/4-TOC60	BOOMJET NOZZLE BRASS	255.87
46024	INLET CLAMP SUB/ASBY	32.36	4629-3/4-TOC80	BOOMJET NOZZLE,BRASS	255.87
46070	OUTLETCLAMP,SUB ASBY	25.29	462BE-2Q-D	460 Manifold	1156.22
46158-144P-1-3	3 WAY DIRECTOVALVE	393.06	462BEC-23-C	460 MANIFOLD	1156.22
461BE-23-CPU	460 MANIFOLD	581.72	462BEC-23-D	460 MANIFOLD	1156.22
461BE-2F-D	460 MANIFOLD	565.63	462BEC-24-C	460 MANIFOLD	1156.22
461BE-2Q-C	460 MANIFOLD	565.63	462BEC-24-CVX	460 MANIFOLD	1200.23
461BE-2Q-D	460 MANIFOLD	565.63	462BEC-24-D	460 MANIFOLD 1"	1156.22
461BEC-23-C	460 MANIFOLD	565.63	462BEC-2F-C	460 MANIFOLD	1156.22
461BEC-23-CN	460 MANIFOLD NEG	565.63	462BEC-2F-C15	460 MANIFOLD	1185.04
461BEC-23-D	460 MANIFOLD	565.63	462BEC-2F-COC	460 MANIFOLD	1178.09
461BEC-24-C	460 MANIFOLD	565.63	462BEC-2F-D	460 MANIFOLD	1156.22

PART NO.	DESCRIPTION	U.S.DOLLARS	PART NO.	DESCRIPTION	U.S.DOLLARS
462BEC-2Q-C	460 MANIFOLD	1156.22	463BEC-3CF-CVX	460 MANIFOLD	2559.57
462BEC-2Q-C15TU	460BEC MANIFOLD	1228.84	463BEC-3CQ-COB	460 MANIFOLD	2559.57
462BEC-2Q-C60TU	460 MANIFOLD	1306.24	463BEC-3CQ-D	460 MANIFOLD	2494.34
462BEC-2Q-COC	460 MANIFOLD	1200.10	463BEC-3E3-C	460 MANIFOLD	2815.37
462BEC-2Q-COU	460BEC MANIFOLD	1200.10	463BEC-3E4-C	460 MANIFOLD	2815.37
462BEC-2Q-CVX	460 MANIFOLD QC	1200.10	463BEC-3E4-CPB	460 MANIFOLD	2881.19
462BEC-2Q-D	460 MANIFOLD	1156.22	463BEC-3E4-CVX	460 MANIFOLD	2881.19
462BEC-3CF-C60	460 SHUTOFF/BYPASS	1758.40	463BEC-3E4-P	460 MANIFOLD LESS CABLE	2751.16
462BEC-3CF-CPG	460 SHUTOFF/BYPASS	1696.11	463BEC-3EF-C	460 MANIFOLD	2815.37
462BEC-3CF-CVX	460 SHUTOFF/BYPASS	1696.11	463BEC-3EF-C03PG	460 MANIFOLD	2881.19
462BEC-3CF-D	460 SHUTOFF/BYPASS	1652.24	463BEC-3EF-COB	460 MANIFOLD	2881.19
462BEC-3CQ-C03VX	460 SHUTOFF/BYPASS	1696.11	463BEC-3EF-D	460 MANIFOLD	2815.37
462BEC-3CQ-D	SHUTOFF/BYPASS VALVE	1652.24	463BEC-3EF-P	460 MANIFOLD LESS CABLE	2739.19
462BEC-3E3-C	BALL VALVE ASSEMBLY	1866.22	463BEC-3EQ-C	MANIFOLD BALL VALVE	2815.37
462BEC-3E3-CK	460 MANIFOLD	1903.38	463BEC-3EQ-CK	460BYPASS MANIFOLD	2848.40
462BEC-3E4-CPB	460 MANIFOLD	1910.08	463BEC-3EQ-COB	460 SHUTOFF/BYPASS	2881.19
462BEC-3EF-C	BALL VALVE ASSEMBLY	1866.22	463BEC-3EQ-D	MANIFOLD BALL VALVE	2815.37
462BEC-3EF-CPB	SUTOFF/BYPASS FLANGE	1910.08	463BEC-3FB3-D	460 MANIFOLD	2994.07
462BEC-3EF-CVX	SUTOFF/BYPASS FLANGE	1910.08	463BEC-3FB4-C	460 MANIFOLD	2994.07
462BEC-3EQ-C	460 MANIFOLD	1866.22	463BEC-3FB4-COC	460 MANIFOLD	2559.57
462BEC-3FB3-C	FLOWBACK MANIFOLD	1985.36	463BEC-3FB4-CVX	FLOWBACK MANIFOLD	3060.01
462BEC-3FB3-CVX	FLOWBACK MANIFOLD	2029.32	463BEC-3FBF-C	460 MANIFOLD	2994.07
462BEC-3FB4-C03	460 FLOWBACK	1985.36	463BEC-3FBF-COC	460 MAIFOLD	3060.01
462BEC-3FB4-CVX	FLOWBACK MANIFOLD	2029.32	463BEC-3FBF-CVX	FLOWBACK MANIFOLD	3060.03
462BEC-3FBF-C	SHUTOFF/BYPASS FLANG	1985.36	463BEC-3FBF-P	460 MANIFOLD LESS CABLE	2929.85
4635-1	INLET ASB,BRASS,3/4Q	24.06	464BE-2F-D	460 MANIFOLD	2337.47
463BE-2F-D	460 MANIFOLD	1746.84	464BE-2Q-C15	460 QC MANIFOLD	2394.99
463BE-2Q-C15	460 QC MANIFOLD	1789.97	464BEC-23-C	460 MANIFOLD	2337.47
463BEC-23-C	460 MANIFOLD	1746.84	464BEC-23-D	460 MANIFOLD	2337.47
463BEC-23-CVX	460 MANIFOLD	1812.67	464BEC-24-C	460 MANIFOLD	2337.47
463BEC-23-D	460 MANIFOLD	1746.84	464BEC-24-COC	460 MANIFOLD 1"	2425.27
463BEC-23-P	460 MANIFOLD LESS CABLE	1682.62	464BEC-24-CVX	460 MANIFOLD	2425.27
463BEC-24-C	460 MANIFOLD	1746.84	464BEC-24-D	460 MANIFOLD 1"	2337.47
463BEC-24-C15	460 MANIFOLD	1789.97	464BEC-2F-C	460 MANIFOLD	2337.47
463BEC-24-CNOG	460 MANIFOLD	1812.67	464BEC-2F-C15	460 MANIFOLD	2400.03
463BEC-24-COC	460 MANIFOLD 1"	1812.67	464BEC-2F-D	460 MANIFOLD	2337.47
463BEC-24-CVX	460 MANIFOLD	1812.67	464BEC-2Q-C	460 MANIFOLD	2337.47
463BEC-24-D	460 MANIFOLD 1"	1746.84	464BEC-2Q-C15	460 MANIFOLD	2394.99
463BEC-2F-C	460 MANIFOLD	1746.84	464BEC-2Q-COC	460 MANIFOLD	2425.27
463BEC-2F-C03	460 MANIFOLD	1746.84	464BEC-2Q-COU	464BEC-2Q-C MANIFOLD BALL VALVE ASB.	2425.27
463BEC-2F-C15	460 MANIFOLD	1789.97	464BEC-2Q-CVX	460 MANIFOLD	2425.27
463BEC-2F-COC	460 MANIFOLD	1812.67	464BEC-2Q-D	464 MANIFOLD	2337.47
463BEC-2F-CPB	460 MANIFOLD	1812.67	464BEC-3CF-C	464 MANIFOLD	3336.51
463BEC-2F-CPG	460 MANIFOLD	1812.67	464BEC-3CF-CVX	SHUTOFF/BYPASS FLANG	3424.26
463BEC-2F-CVX	460 MANIFOLD	1812.67	464BEC-3CF-D	SHUTOFF/BYPASS FLANG	3336.51
463BEC-2F-D	460 MANIFOLD	1746.84	464BEC-3CQ-C	SHUTOFF/BYPASS QC	3336.51
463BEC-2F-DN	460 MANIFOLD NEG 50F	1746.84	464BEC-3CQ-C15	SHUTOFF/BYPASS QC	3394.06
463BEC-2Q-C	463 MANIFOLD	1746.84	464BEC-3CQ-D	464 MANIFOLD	3336.51
463BEC-2Q-C03	460 MANIFOLD	1746.84	464BEC-3E4-C	460 MANIFOLD	3336.51
463BEC-2Q-C15	463 MANIFOLD	1789.98	464BEC-3EF-C	460 MANIFOLD	3764.71
463BEC-2Q-COB	463 MANIFOLD	1812.67	464BEC-3EF-COB	460 MANIFOLD	3786.73
463BEC-2Q-COC	463 MANIFOLD	1812.67	464BEC-3EF-CPG	460 MANIFOLD	3786.73
463BEC-2Q-COU	460BEC MANIFOLD	1812.67	464BEC-3EQ-C	460 MANIFOLD	3336.51
463BEC-2Q-CVX	460 MANIFOLD	1812.67	464BEC-3EQ-D	460 MANIFOLD	3336.51
463BEC-2Q-D	460MANIFOLD	1746.84	464BEC-3FBF-C	460 MANIFOLD	4002.81
463BEC-3C3-CVX	SUTOFF/BYPASS 3/4"	2559.57	464BEC-3FBF-COC	460 MANIFOLD	4090.56
463BEC-3C4-C	460 MANIFOLD	2494.34	464BEC-3FBF-D	460 MANIFOLD	4002.81
463BEC-3C4-C15	460 MANIFOLD	2537.44	464BEC-3FBQ-D	464 MANIFOLD	4002.81
463BEC-3C4-CVX	BYPASS/SHUTOFF 1"	2559.57	46500AD-1-1/2-PPB	PROMAX CLIP EYELET	17.86
463BEC-3C4-P	460 MANIFOLD LESS CABLE	2430.11	46541-1	CONTROL HARNESS SUB	8.98
463BEC-3CF-C	460 MANIFOLD	2494.34	46541-2	CONTROL HARNESS SUB	8.98
463BEC-3CF-C15	460 MANIFOLD	2537.44	46550-1-1/2-PP	EDUCTOR	170.84
463BEC-3CF-C60	460 MANIFOLD	2653.55	46550-1/4-PP	EDUCTOR, PP	64.68
463BEC-3CF-COC	460 MANIFOLD	2559.57			

PART NO.	DESCRIPTION	U.S.DOLLARS	PART NO.	DESCRIPTION	U.S.DOLLARS
465BE-24-C	460 MANIFOLD	2928.10	4673-36	CURVED EXTENSION,BR.	42.96
465BE-2Q-C	460 MANIFOLD QC	2928.10	4673-48	CURVED EXTENSION,BR.	49.16
465BE-2Q-C15	460 MANIFOLD	2942.47	4673-8	CURVED EXTENSION,BR.	29.87
465BE-3FB3-C60OC	460 FLOWBACK	5387.43	4676-1/2	TEEJET ADAPTER,BRASS	12.99
465BEC-23-C	460 MANIFOLD	2928.10	4676-1/4	TEEJET ADAPTER,BRASS	4.24
465BEC-23-COB	460 MANIFOLD	3037.86	4676-1/8	TEEJET ADAPTER,BRASS	4.24
465BEC-23-COC	460 MANIFOLD	3037.86	4676-3/4	TEEJET ADAPTER,BRASS	17.85
465BEC-23-D	460 MANIFOLD	2928.10	4676-3/8	TEEJET ADAPTER,BRASS	4.24
465BEC-24-C	460 MANIFOLD	2928.10	4676-AL-1/4	TEEJET ADAPTER,ALUM.	4.12
465BEC-24-C15	460 MANIFOLD	2942.47	4676-AL-1/8	TEEJET ADAPTER,ALUM.	4.12
465BEC-24-CVX	460 MANIFOLD	3037.86	4676-ENP-1/4	TEEJET ADPTR,ENP	4.81
465BEC-24-D	440 MANIFOLD 1"	2928.10	4676-ENP-1/8	TEEJET ADPTR,ENP	4.81
465BEC-2F-C	460 MANIFOLD	2928.10	4676-ENP-3/8	TEEJET ADPTR,ENP	4.81
465BEC-2F-C15	460 MANIFOLD	2942.47	4676-NYB-1/4	TEEJET ADAPTER,NYLON	3.49
465BEC-2F-C15OC	460 MANIFOLD	3052.50	4676-NYB-1/8	TEEJET ADAPTER,NYLON	3.49
465BEC-2F-C60	460 MANIFOLD	3211.13	4676-SS-1/2	TEEJET ADAPTER,SS	31.72
465BEC-2F-COB	460 MANIFOLD	3037.86	4676-SS-1/4	TEEJET ADAPTER,SS	14.26
465BEC-2F-COC	460 MANIFOLD	3037.86	4676-SS-1/8	TEEJET ADAPTER,SS	14.26
465BEC-2F-CVX	460 MANIFOLD	3037.86	4676-SS-3/4	TEEJET ADAPTER,SS	51.91
465BEC-2F-D	460 MANIFOLD	2928.10	4676-SS-3/8	TEEJET ADAPTER,SS	23.09
465BEC-2Q-C	460 MANIFOLD	2928.10	467BEC-23-CPU	460 MANIFOLD	4131.58
465BEC-2Q-C15	460 QC MANIFOLD	2942.47	467BEC-2F-D	460 MANIFOLD	4109.58
465BEC-2Q-COB	460 MANIFOLD	3037.86	467BEC-2Q-C	460 MANIFOLD	4109.58
465BEC-2Q-COC	460 MANIFOLD	3037.86	467BEC-2Q-CVX	460 MANIFOLD	4131.58
465BEC-2Q-CVX	460 MANIFOLD	3037.86	467BEC-2Q-D	460 MANIFOLD	4109.58
465BEC-2Q-D	460MANIFOLD	2928.10	467BEC-3CQ-CN15RB	460 SHUTOFF/BYPASS	6179.88
465BEC-3C4-C	460 SHUTOFF/BYPASS	4178.69	467BEC-3CQ-D	460 MANIFOLD	5976.01
465BEC-3CF-C	460 SHUTOFF/BYPASS	4178.69	467BEC-3FBF-C	460 FLOWBACK MANIFLD	6863.92
465BEC-3CF-COB	460 SHUTOFF/BYPASS	4288.48	467BEC-3FBQ-C	460 FLOWBACK MANIFLD	6863.92
465BEC-3CQ-CN15RB	460 SUTOFF/BYPASS	4405.03	467BEC-3FBQ-CN15RB	460 FLOWBACK MANIFLD	7284.58
465BEC-3CQ-D	460 MANIFOLD	4178.69	467BEC-3FBQ-D	460 FLOWBACK MANIFLD	6863.92
465BEC-3E3-C	460 SHUTOFF/BYPASS	4771.14	4688	TRIGGER TEEJET VALVE	70.98
465BEC-3EF-C	460 MANIFOLD	4771.14	4688-VI	TRIG.TEEJT.VLV.W/VI	80.92
465BEC-3FB4-C	460 FLOWBACK MANIFLD	5012.36	469BEC-23-C	460 MANIFOLD	5085.94
465BEC-3FB4-C15	460 FLOWBACK	5084.24	469BEC-2Q-C15VX	460 MANIFOLD	5665.06
465BEC-3FBF-C15	460 FLOWBACK	5084.24	469BEC-2Q-D	460 MANIFOLD	5085.94
465BEC-3FBF-C15J	460 FLOWBACK MANIFLD	5139.39	469BEC-3FBF-C	FLOWBACK MANIFOLD	9047.88
465BEC-3FBF-COC	460 FLOWBACK	5122.20	469BEC-3FBQ-D	FLOWBACK AMNIFOLD	8850.40
465BEC-3FBF-CPG	460 FLOWBACK	5122.20	4720	SWIVEL BODY ASB.	17.61
465BEC-3FBF-D	460 MANIFOLD	5012.36	4727	SURE GRIP HANDLE(M)	17.92
465BEC-3FBQ-C	460 FLOWBACK MANIFLD	5012.36	4727-NP	NP SURE GRIP HANDLE (M)	25.80
465BEC-3FBQ-CN15RB	460 FLOWBACK MANIFLD	5194.08	4754	SURE GRIP HANDLE(F)	24.09
465BEC-3FBQ-CVX	460 FLOWBACK MANIFLD	5122.20	4765-250	SIPHON VALVE,BRASS	86.87
465BEC-3FBQ-D	460 MANIFOLD	5012.36	4765-500	SIPHON VALVE,BRASS	86.87
4664B	DIAPH.CHECK VALVE BRASS (#8 SPRING)	42.99	4765-SS-250	SIPHON VALVE,ST.STL.	169.04
4664B-AL	DIAPH.CHECK VALVE AL (#8 SPRING)	46.66	4765-SS-500	SIPHON VALVE,ST.STL	169.04
4666B	DIAPH.CHECK VALVE BR (#8 SPRING)	42.99	48143	MOUNTING KIT	21.18
466BE-3CQ-D	460 SHUTOFF/BYPASS	5021.01	4817	VALVE STEM ASB,BRASS	13.97
466BEC-23-C	460 MANIFOLD	3518.76	4817-1	VALVE STEM,W/VI.DISC	20.71
466BEC-23-D	460 MANIFOLD	3518.78	4817-2	VALVE STEM,TEF.DISC	21.99
466BEC-24-D	460 MANIFOLD	3518.78	48500-1-ECS17560A	SPLT EYELET W/CBLE	309.83
466BEC-2F-DN	460 MANIFOLD NEG	3518.78	48500-2-ECS17560A	SPLT EYELET W/CABLE	309.83
466BEC-2Q-C	460 MANIFOLD QC	3518.78	4865	WALL MTG.CAP,BRASS	29.54
466BEC-2Q-COC	460 MANIFOLD	3650.81	48650-1-126ML-5	1-1/4" LESS SCREEN	73.05
466BEC-2Q-CVX	460 MANIFOLD	3650.81	48650-1-126ML-6	1-1/2" LESS SCREEN	73.05
466BEC-2Q-DN	460 MANIFOLD NEG	3518.76	48650-1-126ML-F75	FLANGED STRAINER.LESS SCREEN	73.05
466BEC-3FB4-C	460 FLOWBACK	5998.14	48650-2-126ML-F75-50	FLANGED STRAINER GAUGE PORT	118.48
466BEC-3FBF-COC	460 FLOWBACK	6152.06	48650-2-126ML-F75-80	FLANGED STRAINER GAUGE PORT	118.48
4673-18	CURVED EXTENSION,BR.	34.74	4908-1/4T	TEEJET REG.BODY ASB.	13.63
4673-24	CURVED EXTENSION,BR.	36.50	4908-1/4T-AL	TEEJET REG.BODY ASB.	13.11
4673-30	CURVED EXTENSION,BR.	40.17	4908-1/4T-SS	TEEJET REG.BODY ASB.	60.09
			4908-1/4TT	TEEJET REG.BODY ASB.	13.63

PART NO.	DESCRIPTION	U.S.DOLLARS	PART NO.	DESCRIPTION	U.S.DOLLARS
4908-1/4TT-SS	TEEJET REG.BODY ASB.	60.09	50287-2-NYR	QT CAP/WASHER/WHITE	1.85
4908-1/8T	TEEJET REG.BODY ASB.	13.63	50287-3-NYR	QT CAP/WASHER/RED	1.85
4908-1/8TT	TEEJET REG.BODY ASB.	13.63	50287-4-NYR	QT CAP/WASHER/BLUE	1.85
491BEC-C	490 MANIFOLD	686.43	50287-5-NYR	QT CAP/WASHER/GREEN	1.85
491BEC-C15	490 MANIFOLD	700.81	50287-6-NYR	QT CAP/WASHER/YELLOW	1.85
491BEC-C60IU	490 MANIFOLD AIRJET	761.39	50287-7-NYR	QT CAP/WASHER/BROWN	1.85
491BEC-C60TU	490 MANIFOLD	761.39	50287-8-NYR	QT CAP/WASHER/ORANGE	1.85
491BEC-COC	490 SINGLE MANIFOLD	708.35	50490-1-126ML-3	3/4" LESS SCREEN	29.55
491BEC-CPC	490 SINGLE MANIFOLD	708.35	50490-1-126ML-4	1" LESS SCREEN	29.55
491BEC-CPU	490 SINGLE MANIFOLD	708.35	50490-1-126ML-F50	FLANGE LESS SCREEN	29.55
491BEC-CQC	490 MANIFOLD	708.35	50515-22CN03	BEC NEG REPL MOTOR	390.57
491BEC-CRC	490 MANIFOLD	708.35	50515-22CN05	BEC NEG REPL MOTOR	390.57
491BEC-CVR	490 MANIFOLD	708.35	50515-22CN15	BEC NEG REPL MOTOR	404.93
491BEC-CVX	490 MANIFOLD	708.35	50515-22CN15RB	BEC NEG REPL MOTOR	427.61
491BEC-CWX	490 MANIFOLD	708.35	50515-22CP03	BEC POS REPL MOTOR	390.57
491BEC-D	490 MANIFOLD	686.43	50515-22CP03OB	BEC POS REPL MOTOR	412.53
491BEC-DN	BALL VALVE ASSEMBLY	686.43	50515-22CP03OG	BEC POS REPL MOTOR	412.53
492BEC-C	490 MANIFOLD	1389.76	50515-22CP03PG	BEC POS REPL MOTOR	412.53
492BEC-C15	490BEC MANIFOLD	1418.49	50515-22CP03PT	BEC POS REPL MOTOR	412.53
492BEC-C15TU	490BEC MANIFOLD	1433.60	50515-22CP05	BEC POS REPL MOTOR	390.57
492BEC-COC	490 MANIFOLD	1433.60	50515-22CP05J	BEC POS REPL MOTOR	401.56
492BEC-CVX	490 MANIFOLD	1433.60	50515-22CP05K	BEC POS REPL MOTOR	401.56
492BEC-D	490 MANIFOLD	1389.76	50515-22CP05OB	BEC POS REPL MOTOR	412.53
493BE-D	490 MANIFOLD	2093.09	50515-22CP05OC	BEC POS REPL MOTOR	412.53
493BEC-C	490 MANIFOLD	2093.09	50515-22CP05OG	BEC POS REPL MOTOR	412.53
493BEC-C03LB	490 MANIFOLD	2158.91	50515-22CP05OK	BEC POS REPL MOTOR	412.53
493BEC-C03PG	490 MANIFOLD	2158.91	50515-22CP05PB	BEC POS REPL MOTOR	412.53
493BEC-C15	490BEC MANIFOLD	2136.27	50515-22CP05PC	BEC POS REPL MOTOR	412.53
493BEC-COC	490 MANIFOLD	2158.91	50515-22CP05PG	BEC POS REPL MOTOR	412.53
493BEC-CPC	490 MANIFOLD	2158.91	50515-22CP05PK	BEC REPL MOTOR	412.53
493BEC-CPU	490 MANIFOLD	2158.91	50515-22CP05PS	BEC POS REPL MOTOR	412.53
493BEC-CQC	490 MANIFOLD	2158.91	50515-22CP05PU	BEC POS REPL MOTOR	412.53
493BEC-CRC	490 MANIFOLD	2158.91	50515-22CP05RC	BEC POS REPL MOTOR	412.53
493BEC-CVX	490 MANIFOLD	2158.91	50515-22CP05SB	BEC POS REPL MOTOR	412.53
493BEC-D	490 MANIFOLD	2093.09	50515-22CP05UX	BEC POS REPL MOTOR	412.53
493BEC-P	490 MANIFOLD LESS CABLE	2028.89	50515-22CP05VR	BEC POS REPL MOTOR	412.53
494BEC-C	490 MANIFOLD	2796.45	50515-22CP05VX	BEC POS REPL MOTOR	412.53
494BEC-CRB	490 MANIFOLD	2884.14	50515-22CP05WX	BEC POS REPL MOTOR	412.53
494BEC-CVX	490 MANIFOLD	2884.50	50515-22CP15	BEC POS REPL MOTOR	404.93
494BEC-D	490 MANIFOLD	2796.45	50515-22CP15OC	BEC POS REPL MOTOR	427.61
494BEC-P	490 MANIFOLD	2710.83	50515-22CP15PB	BEC POS REPL MOTOR	427.61
495BEC-C	490 MANIFOLD	3499.77	50515-22CP15PC	BEC POS REPL MOTOR	398.58
495BEC-C15	490 MANIFOLD	3571.56	50515-22CP15PG	BEC POS REPL MOTOR	427.61
495BEC-C60TU	490 MANIFOLD	3874.67	50515-22CP15TU	BEC POS REPL MOTOR	427.61
495BEC-CCS	490 MANIFOLD	3609.55	50515-22CP15VX	BEC POS REPL MOTOR	427.61
495BEC-COC	490 MANIFOLD	3609.55	50515-22CP60	BEC POS REPL MOTOR	443.60
495BEC-CSC	490 MANIFOLD	3609.55	50515-22CP60OB	BEC POS REPL MOTOR	465.58
495BEC-CVX	490 MANIFOLD	3609.55	50515-22CP60OU	BEC POS REPL MOTOR	465.58
495BEC-D	490 MANIFOLD	3499.77	50515-22CP60TU	BEC POS REPL MOTOR	465.58
495BEC-P	490 MANIFOLD	3499.77	50515-22DN	BEC NEG REPL MOTOR	390.57
49880A-31-05-NYB	DCV AIRJET ASB	134.14	50515-22DP	BEC POS REPL MOTOR	390.57
49880A-35-05-NYB	DCV AIRJET ASB	134.14	50515-22N	BEC NEG REPL MOTOR LESS CABLE	369.17
49880A-42-05-NYB	DCV AIRJET ASB	134.14	50515-22P	BEC POS REPL MOTOR LESS CABLE	369.17
49880A-52-05-NYB	DCV AIRJET ASB	134.14	50515-22QN	22RPM BEC NEG REPL MOTOR DEUTSCH	369.16
49880A-62-05-NYB	DCV AIRJET ASB	134.14	50515-22QP	22RPM BEC POS REPL MOTOR DEUTSCH	369.16
49880E-31-05-NYB	DCV AIRJET ASB	134.14	50515-25CN03	BEC NEG REPL MOTOR	390.57
49880E-35-05-NYB	DCV E AIRJET ASB	134.14	50515-25CN05	BEC NEG REPL MOTOR	390.57
49880E-42-05-NYB	DCV E AIRJET ASB	134.14	50515-25CN15	BEC NEG REPL MOTOR	404.93
49880E-52-05-NYB	DCV E AIRJET ASB	134.14	50515-25CN15RB	BEC NEG REPL MOTOR	427.61
49880E-62-05-NYB	DCV E AIRJET ASB	134.14	50515-25CN60	BEC NEG REPL MOTOR	443.60
5000-1/4T	TEEJET SW.BDY ASB,BR	26.57			
5000-1/8T	TEEJET SW.BDY ASB,BR	26.57			
50175-1	CHECK VALVE, PP	6.71			
50287-1-NYR	QT CAP/WASHER/BLACK	1.85			

PART NO.	DESCRIPTION	U.S.DOLLARS	PART NO.	DESCRIPTION	U.S.DOLLARS
50515-25CP03	BEC POS REPL MOTOR	390.57	50516-03C05VX	3RPM 6SEC R&RL MOTOR	423.85
50515-25CP03B	BEC POS REPL MOTOR	412.53	50516-03C05WB	3RPM 6SEC R&RL MOTOR	428.01
50515-25CP03OG	BEC POS REPL MOTOR	412.53	50516-03C15	3RPM 6SEC R&RL MOTOR	428.97
50515-25CP03PG	BEC POS REPL MOTOR	412.53	50516-03C60	3RPM 6SEC R&RL MOTOR	467.64
50515-25CP05	BEC POS REPL MOTOR	390.57	50516-03C60IG	3RPM 6SEC R&RL MOTOR	489.63
50515-25CP05J	BEC POS REPL MOTOR	401.56	50516-03D	3RPM 6SEC R&RL MOTOR	414.60
50515-25CP05K	BEC POS REPL MOTOR	401.56	50516-03Q	3RPM 6SEC R&RL MOTOR DEUTSCH	393.77
50515-25CP05OB	BEC POS REPL MOTOR	412.53	50516-04C05	4RPM 4SEC R VALV	501.88
50515-25CP05OC	BEC POS REPL MOTOR	412.53	50516-04C05EC	4RPM 4SEC R VALV CHN	523.82
50515-25CP05PB	BEC POS REPL MOTOR	412.53	50516-04Q	4RPM 4SEC R&RL MOTOR DEUTSCH	393.77
50515-25CP05PC	BEC POS REPL MOTOR	412.53	50516-06	6RPM 3SEC R&RL MOTR LESS CABLE	393.77
50515-25CP05PK	BEC POS REPL MOTOR	412.53	50516-06C03	6RPM 3SEC R&RL MOTOR	414.60
50515-25CP05PU	BEC POS REPL MOTOR	412.53	50516-06C05	6RPM 3SEC R&RL MOTOR	414.60
50515-25CP05QC	BEC POS REPL MOTOR	412.53	50516-06C05CS	6RPM 3SEC R&RL MOTOR	436.57
50515-25CP05RX	BEC POS REPL MOTOR	412.53	50516-06C05ES	6RPM 3SEC R&RL MOTOR	436.57
50515-25CP05UX	BEC POS REPL MOTOR	412.53	50516-06C05UG	6RPM 3SEC R&RL MOTOR	436.57
50515-25CP05VI	BEC POS REPL MOTOR	412.53	50516-06C05UK	6RPM 3SEC R&RL MOTOR	436.57
50515-25CP05VS	BEC POS REPL MOTOR 25 RPM	412.53	50516-06C15	6RPM 3SEC R&RL MOTOR	428.97
50515-25CP05VX	BEC POS REPL MOTOR	412.53	50516-06C60	6RPM 3SEC R&RL MOTOR	467.64
50515-25CP15	BEC POS REPL MOTOR	443.60	50516-06D	6RPM 3SEC R&RL MOTOR	414.60
50515-25CP15PB	BEC POS REPL MOTOR	427.61	50516-06Q	6RPM 2SEC R&RL MOTOR DEUTSCH	393.77
50515-25CP15TU	BEC POS REPL MOTOR	427.61	5053-100-SS	TEEJET STR.W/100 MESH SCREEN	4.29
50515-25CP60	BEC POS REPL MOTOR	443.60	5053-200-SS	TEEJET STR.W/200SS SCR N	4.29
50515-25DN	BEC NEG REPL MOTOR	390.57	5053-24-SS	TEEJET STR.W/SS SCR N	4.29
50515-25DP	BEC POS REPL MOTOR	390.57	5053-50-SS	TEEJET STR.W/50SS SCR N	4.29
50515-25N	BEC NEG REPL MOTOR LESS CABLE	369.17	5053-80-SS	TEEJET STR.W/80SS SCR N	4.29
50515-25P	BEC POS REPL MOTOR LESS CABLE	369.17	50533-22	BE REPL MOTOR LESS CABLE	369.17
50515-25QN	25RPM BEC NEG REPL MOTOR DEUTSCH	369.16	50533-22C03	BE MOTOR REPLACEMENT	390.57
50515-25QP	25RPM BEC POS REPL MOTOR DEUTSCH	369.16	50533-22C05	BE MOTOR REPLACEMENT	390.57
50516-01	1RPM 18SEC R&RL MOTR LESS CABLE	393.77	50533-22C05B	BE MOTOR REPLACEMENT	401.60
50516-01C03	1RPM 18SEC R&RL MOTR	414.60	50533-22C05J	BE MOTOR REPLACEMENT	401.60
50516-01C05	1RPM 18SEC R&RL MOTR	414.60	50533-22C05OB	BE MOTOR REPLACEMENT	412.53
50516-01C05B	1RPM 18SEC R&RL MOTR	425.67	50533-22C05PG	BE MOTOR REPLACEMENT	390.57
50516-01C05CS	1RPM 18SEC RPL MOTOR	436.57	50533-22C05PS	BE MOTOR REPLACEMENT	412.53
50516-01C05EC	1RPM 18SEC RPL MOTOR	436.57	50533-22C15	BE MOTOR REPLACEMENT	404.93
50516-01C05UQ	1RPM 18SEC R&RL MOTOR	436.57	50533-22C60	BE MOTOR REPLACEMENT	443.60
50516-01C15	1RPM 18SEC R&RL MOTR	428.97	50533-22C60TU	BE MOTOR REPLACEMENT	465.58
50516-01C15HC	1RPM 18SEC R&RL MOTR	450.94	50533-22D	BE MOTOR REPLACEMENT	390.57
50516-01C15IG	1RPM 18SEC R&RL MOTR	450.94	50533-22Q	22RPM BE REPL MOTOR DEUTSCH	369.16
50516-01C60	1RPM 18SEC R&RL MOTR	467.64	50533-25	BE REPL MOTOR LESS CABLE	369.17
50516-01D	1RPM 18SEC R&RL MOTR	414.60	50533-25C03	BE MOTOR REPLACEMENT	390.59
50516-01Q	1RPM 18SEC R&RL MOTOR DEUTSCH	393.77	50533-25C05	BE MOTOR REPLACEMENT	390.57
50516-03	3RPM 6SEC R&RL MOTR LESS CABLE	393.77	50533-25C05PU	BE MOTOR REPLACEMENT	412.53
50516-03C03	3RPM 6SEC R&RL MOTOR	414.60	50533-25C15	BE MOTOR REPLACEMENT	404.93
50516-03C03CC	3RPM 6SEC R&RL MOTOR	436.57	50533-25C60	BE MOTOR REPLACEMENT	443.60
50516-03C03FS	3RPM 6SEC R&RL MOTOR	436.57	50533-25D	BE MOTOR REPLACEMENT	390.57
50516-03C03GS	3RPM 6SEC R&RL MOTOR	436.57	50533-25Q	25RPM BE REPL MOTOR DEUTSCH	369.16
50516-03C03UG	3RPM 6SEC R&RL MOTOR	436.57	5054-100-SS	TEEJET STR.BR&ST.STL	14.71
50516-03C05	3RPM 6SEC R&RL MOTOR	414.60	5054-50-SS	TEEJET STR.BR&ST.STL	14.71
50516-03C05CC	3RPM 6SEC R&RL MOTOR	436.57	50678-10-HSS	FLOODJET NOZZLE 416SS	18.81
50516-03C05CS	3RPM 6SEC R&RL MOTOR	436.57	50678-10-SS	FLOODJET AIRJET TIP	18.68
50516-03C05EC	3RPM 6SEC R&RL MOTOR	436.57	50678-10E-SS	FLOODJET E AIRJET	18.68
50516-03C05ES	3RPM 6SEC R&RL MOTOR	436.57	50800-15-PP-300	TRIGERJET WITH X18	24.09
50516-03C05FS	3RPM 6SEC R&RL MOTOR	436.57	50800-15-PP-300-X26	TRIGGERJET	24.09
50516-03C05GS	3RPM 6SEC R&RL MOTOR	436.57	50800-15-PP-406	TRIGGERJET WITH X18	24.09
50516-03C05OC	3RPM 6SEC R&RL MOTOR	436.57	50800-15-PP-406-X12	TRIGGERJET WITH X12	24.09
50516-03C05UG	3RPM 6SEC R&RL MOTOR	436.57	50800-15-PP-406-X26	TRIGGERJET	24.09
50516-03C05UK	3RPM 6SEC R & RL MOTOR	436.57	50800-15-PP-406-X8	TRIGGERJET	24.09
			50800-21-AL-300	TRIGGERJET WITH X18	28.79

PART NO.	DESCRIPTION	U.S.DOLLARS	PART NO.	DESCRIPTION	U.S.DOLLARS
50800-21-AL-300-X26	TRIGGERJET	28.79	50996-03C03	3RPM 12SEC PR MOTOR	414.60
50800-21-AL-300-X8	TRIGGERJET	28.79	50996-03C05	3RPM 12SEC PR MOTOR	414.60
50800-21-AL-406	TRIGGERJET WITH X18	28.79	50996-03C05CS	3RPM 12SEC PR MOTOR	436.57
50800-21-AL-406-X12	TRIGGERJET WITH X12 TIP	28.79	50996-03C05EC	3RPM 12SEC PR MOTOR	436.57
50800-21-AL-406-X26	TRIGGERJET	28.79	50996-03C05FC	3RPM 12SEC PR MOTOR	436.57
50800-21-AL-406-X8	TRIGGERJET	28.79	50996-03C05FS	3RPM 12SEC PR MOTOR	436.57
50800-PP-300	TRIGGERJET	18.51	50996-03C05GC	3 RPM 12 SEC REG MOTOR	436.57
50800-PP-406	TRIGGERJET	18.51	50996-03C15	3RPM 12SEC PR MOTOR	428.97
5082-1/4X1/4	SWIVEL CONNECT,BRASS	23.54	50996-03C15TU	3RPM 12SEC PR MOTOR	451.66
50854-NYB	STREAMJET ADAPTER	5.83	50996-03C60	3RPM 12SEC PR MOTOR	467.64
50994-22CN15RB	NORMAL OPEN MOTOR	426.83	50996-03D	3RPM 12SEC PR MOTOR	414.60
50994-22CP03	NORMAL OPEN MOTOR	390.57	50996-03Q	3RPM 12SEC PR MOTOR DEUTSCH	393.77
50994-22CP05	NORMAL OPEN MOTOR	390.57	50996-06	6RPM 6SEC PR MOTOR LESS CABLE	393.77
50994-22CP05QB	NORMAL OPEN MOTOR	404.44	50996-06C03	6RPM 6SEC PR MOTOR	414.60
50994-22CP05VX	NORMAL OPEN MOTOR	404.44	50996-06C03CS	6RPM 6SEC PR MOTOR	436.57
50994-22CP15	NORMAL OPEN MOTOR	404.93	50996-06C03FC	6RPM 6SEC PR MOTOR	436.57
50994-22CP60	NORMAL OPEN MOTOR	443.60	50996-06C05	6RPM 6SEC PR MOTOR	414.60
50994-22CP60TU	NORMAL OPEN MOTOR	465.58	50996-06C05CS	6RPM 6SEC PR MOTOR	436.57
50994-22DN	NORMAL OPEN MOTOR	390.57	50996-06C05UG	6RPM 6SEC PR MOTOR	436.57
50994-22DP	NORMAL OPEN MOTOR	390.57	50996-06C05UK	6RPM 6SEC PR MOTOR	436.57
50994-22N	NOR OPEN NEG REPL MOTOR LESS CABLE	369.17	50996-06C15	6RPM 6SEC PR MOTOR	428.97
50994-22P	NOR OPEN POS REPL MOTOR LESS CABLE	369.17	50996-06C15TU	6RPM 6 SEC PR MOTOR	406.75
50994-22QN	22RPM NORMAL OPEN NEG MOTOR DEUTSCH	369.16	50996-06C60	6RPM 6 SEC PR MOTOR	467.64
50994-22QP	22RPM NORMAL OPEN POS MOTOR DEUTSCH	369.16	50996-06D	6RPM 6SEC PR MOTOR	414.60
50994-25CP03	NORMAL OPEN MOTOR	390.57	50996-06Q	6RPM 6SEC PR MOTOR DEUTSCH	393.77
50994-25CP05	NORMAL OPEN MOTOR	390.57	5310AM-2	530AM MANUAL 2-WAY PLUNGER VALVE ASSEMBLY	481.99
50994-25CP050X	NORMAL OPEN MOTOR	404.44	5310AM-2F50	530AM MANUAL 2-WAY PLUNGER VALVE ASSEMBLY F50	481.99
50994-25CP05PB	NORMAL OPEN MOTOR	404.44	5310AM-2F75	530AM MANUAL 2-WAY PLUNGER VALVE ASSEMBLY F75	481.99
50994-25CP05PC	MOTOR ASSEMBLY	404.44	5311AM-2	530AM MANUAL 2-WAY PLUNGER VALVE ASSEMBLY	524.01
50994-25CP05QC	NORMAL OPEN MOTOR	404.44	5311AM-2F50	530AM MANUAL 2-WAY PLUNGER VALVE ASSEMBLY F50	524.01
50994-25CP05UX	NORMAL OPEN MOTOR	404.44	5311AM-2F75	530AM MANUAL 2-WAY PLUNGER VALVE ASSEMBLY F75	524.01
50994-25CP05VS	NORMAL OPEN MOTOR	404.44	5312AM-2	530AM MANUAL 2-WAY PLUNGER VALVE ASSEMBLY	565.99
50994-25CP15	NORMAL OPEN MOTOR	404.93	5312AM-2F50	530AM MANUAL 2-WAY PLUNGER VALVE ASSEMBLY F50	565.99
50994-25CP60	NORMAL OPEN MOTOR	443.60	5312AM-2F75	530AM MANUAL 2-WAY PLUNGER VALVE ASSEMBLY F75	565.99
50994-25CP60TU	NORMAL OPEN MOTOR	465.58	5313AM-2	530AM MANUAL 2-WAY PLUNGER VALVE ASSEMBLY	608.00
50994-25CPVX	NORMAL OPEN MOTOR	404.44	5313AM-2F50	530AM MANUAL 2-WAY PLUNGER VALVE ASSEMBLY F50	608.00
50994-25DN	NORMAL OPEN NEG REPL MOTOR	390.57	5313AM-2F75	530AM MANUAL 2-WAY PLUNGER VALVE ASSEMBLY F75	608.00
50994-25DP	NORMAL OPEN MOTOR	390.57	5314AM-2	530AM MANUAL 2-WAY PLUNGER VALVE ASSEMBLY	650.02
50994-25N	NOR OPEN NEG REPL MOTOR LESS CABLE	369.17	5314AM-2F50	530AM MANUAL 2-WAY PLUNGER VALVE ASSEMBLY F50	650.02
50994-25P	NOR OPEN POS REPL MOTOR LESS CABLE	369.17	5314AM-2F75	530AM MANUAL 2-WAY PLUNGER VALVE ASSEMBLY F75	650.02
50994-25QN	25RPM NORMAL OPEN NEG MOTOR DEUTSCH	369.16	5315AM-2	530AM MANUAL 2-WAY PLUNGER VALVE ASSEMBLY	692.01
50994-25QP	25RPM NORMAL OPEN POS MOTOR DEUTSCH	369.16	5315AM-2F50	530AM MANUAL 2-WAY PLUNGER VALVE ASSEMBLY F50	692.01
50996-01	1RPM 36SEC PR MOTOR LESS CABLE	393.77	5315AM-2F75	530AM MANUAL 2-WAY PLUNGER VALVE ASSEMBLY F75	692.01
50996-01C03	1RPM 36SEC PR MOTOR	414.60	531AE-2-D	530AE 2-WAY LQC MANIFOLD	344.52
50996-01C05	1RPM 36SEC PR MOTOR	414.60	531AE-2-P	530AE 2-WAY LQC MANIFOLD MP	323.13
50996-01C05CS	1RPM 36SEC PR MOTOR	436.57	531AE-2F50-D	530AE 2-WAY F50 MANIFOLD	344.52
50996-01C05EC	1RPM 36SEC PR MOTOR	436.57			
50996-01C05UK	1RPM 36SEC PR MOTOR	436.57			
50996-01C15	1RPM 36SEC PR MOTOR	428.97			
50996-01C60	1RPM 36SEC PR MOTOR	467.64			
50996-01D	1RPM 36SEC PR MOTOR	414.60			
50996-01Q	1RPM 36SEC PR MOTOR DEUTSCH	393.77			
50996-03	3RPM 12SEC PR MOTOR LESS CABLE	393.77			

PART NO.	DESCRIPTION	U.S.DOLLARS	PART NO.	DESCRIPTION	U.S.DOLLARS
531AE-2F50-P	530AE 2-WAY F50 MANIFOLD MP	323.13	531AEC-FBQ-P	530AEC FLOWBACK QC MANIFOLD MP	350.69
531AE-2F75-D	530AE 2-WAY F75 MANIFOLD	344.52	531AM-2	530AM MANUAL 2-WAY PLUNGER VALVE ASSEMBLY	103.92
531AE-2F75-P	530AE 2-WAY F75 MANIFOLD MP	323.13	531AM-2F50	530AM MANUAL 2-WAY PLUNGER VALVE ASSEMBLY F50	103.92
531AE-2Q-D	530AE 2-WAY QC MANIFOLD	344.52	531AM-2F75	530AM MANUAL 2-WAY PLUNGER VALVE ASSEMBLY F75	103.92
531AE-2Q-P	530AE 2-WAY QC MANIFOLD MP	323.13	531AM-2Q	530AM MANUAL 2-WAY PLUNGER VALVE ASSEMBLY QC	103.92
531AE-3-D	530AE 3-WAY LQC MANIFOLD	412.73	532AE-2-D	530AE 2-WAY LQC MANIFOLD	625.75
531AE-3-P	530AE 3-WAY LQC MANIFOLD MP	391.34	532AE-2-P	530AE 2-WAY LQC MANIFOLD MP	582.96
531AE-3F50-D	530AE 3-WAY F50 MANIFOLD	412.73	532AE-2F50-D	530AE 2-WAY F50 MANIFOLD	625.75
531AE-3F50-P	530AE 3-WAY F50 MANIFOLD MP	391.34	532AE-2F50-P	530AE 2-WAY F50 MANIFOLD MP	582.96
531AE-3F75-D	530AE 3-WAY F75 MANIFOLD	412.73	532AE-2F75-D	530AE 2-WAY F75 MANIFOLD	625.75
531AE-3F75-P	530AE 3-WAY F75 MANIFOLD MP	391.34	532AE-2F75-P	530AE 2-WAY F75 MANIFOLD MP	582.96
531AE-3Q-D	530AE 3-WAY QC MANIFOLD	412.73	532AE-2Q-D	530AE 2-WAY QC MANIFOLD	625.75
531AE-3Q-P	530AE 3-WAY QC MANIFOLD MP	391.34	532AE-2Q-P	530AE 2-WAY QC MANIFOLD MP	582.96
531AE-FB-D	530AE FLOWBACK LQC MANIFOLD	372.09	532AE-3-D	530AE 3-WAY LQC MANIFOLD	802.36
531AE-FB-P	530AE FLOWBACK LQC MANIFOLD MP	350.69	532AE-3-P	530AE 3-WAY LQC MANIFOLD MP	759.55
531AE-FBF50-D	530AE FLOWBACK F50 MANIFOLD	372.09	532AE-3F50-D	530AE 3-WAY F50 MANIFOLD	802.36
531AE-FBF50-P	530AE FLOWBACK F50 MANIFOLD MP	350.69	532AE-3F50-P	530AE 3-WAY F50 MANIFOLD MP	759.55
531AE-FBF75-D	530AE FLOWBACK F75 MANIFOLD	372.09	532AE-3F75-D	530AE 3-WAY F75 MANIFOLD	802.36
531AE-FBF75-P	530AE FLOWBACK F75 MANIFOLD MP	350.69	532AE-3F75-P	530AE 3-WAY F75 MANIFOLD MP	759.55
531AE-FBQ-D	530AE FLOWBACK QC MANIFOLD	372.09	532AE-3Q-D	530AE 3-WAY QC MANIFOLD	802.36
531AE-FBQ-P	530AE FLOWBACK QC MANIFOLD MP	350.69	532AE-3Q-P	530AE 3-WAY QC MANIFOLD MP	759.55
531AEC-2-D	530AEC 2-WAY LQC MANIFOLD	344.52	532AE-FB-D	530AE FLOWBACK LQC MANIFOLD	680.84
531AEC-2-P	530AEC 2-WAY LQC MANIFOLD MP	323.13	532AE-FB-P	530AE FLOWBACK LQC MANIFOLD MP	638.02
531AEC-2F50-D	530AEC 2-WAY F50 MANIFOLD	344.52	532AE-FBF50-D	530AE FLOWBACK F50 MANIFOLD	680.84
531AEC-2F50-P	530AEC 2-WAY F50 MANIFOLD MP	323.13	532AE-FBF50-P	530AE FLOWBACK F50 MANIFOLD MP	638.02
531AEC-2F75-D	530AEC 2-WAY F75 MANIFOLD	344.52	532AE-FBF75-D	530AE FLOWBACK F75 MANIFOLD	680.84
531AEC-2F75-P	530AEC 2-WAY F75 MANIFOLD MP	323.13	532AE-FBF75-P	530AE FLOWBACK F75 MANIFOLD MP	638.02
531AEC-2Q-D	530AEC 2-WAY QC MANIFOLD	344.52	532AE-FBQ-D	530AE FLOWBACK QC MANIFOLD	680.84
531AEC-2Q-P	530AEC 2-WAY QC MANIFOLD MP	323.13	532AE-FBQ-P	530AE FLOWBACK QC MANIFOLD MP	638.02
531AEC-3-D	530AEC 3-WAY LQC MANIFOLD	412.73	532AEC-2-D	530AEC 2-WAY LQC MANIFOLD	625.75
531AEC-3-P	530AEC 3-WAY LQC MANIFOLD MP	391.34	532AEC-2-P	530AEC 2-WAY LQC MANIFOLD MP	582.96
531AEC-3F50-D	530AEC 3-WAY F50 MANIFOLD	412.73	532AEC-2F50-D	530AEC 2-WAY F50 MANIFOLD	625.75
531AEC-3F50-P	530AEC 3-WAY F50 MANIFOLD MP	391.34	532AEC-2F50-P	530AEC 2-WAY F50 MANIFOLD MP	582.96
531AEC-3F75-D	530AEC 3-WAY F75 MANIFOLD	412.73	532AEC-2F75-D	530AEC 2-WAY F75 MANIFOLD	625.75
531AEC-3F75-P	530AEC 3-WAY F75 MANIFOLD MP	391.34	532AEC-2F75-P	530AEC 2-WAY F75 MANIFOLD MP	582.96
531AEC-3Q-D	530AEC 3-WAY QC MANIFOLD	412.73	532AEC-2Q-D	530AEC 2-WAY QC MANIFOLD	625.75
531AEC-3Q-P	530AEC 3-WAY QC MANIFOLD MP	391.34	532AEC-2Q-P	530AEC 2-WAY QC MANIFOLD MP	582.96
531AEC-FB-D	530AEC FLOWBACK LQC MANIFOLD	372.09	532AEC-3-D	530AEC 3-WAY LQC MANIFOLD	802.36
531AEC-FB-P	530AEC FLOWBACK LQC MANIFOLD MP	350.69	532AEC-3-P	530AEC 3-WAY LQC MANIFOLD MP	759.55
531AEC-FBF50-D	530AEC FLOWBACK F50 MANIFOLD	372.09	532AEC-3F50-D	530AEC 3-WAY F50 MANIFOLD	802.36
531AEC-FBF50-P	530AEC FLOWBACK F50 MANIFOLD MP	350.69	532AEC-3F50-P	530AEC 3-WAY F50 MANIFOLD MP	759.55
531AEC-FBF75-D	530AEC FLOWBACK F75 MANIFOLD	372.09	532AEC-3F75-D	530AEC 3-WAY F75 MANIFOLD	802.36
531AEC-FBF75-P	530AEC FLOWBACK F75 MANIFOLD MP	350.69	532AEC-3F75-P	530AEC 3-WAY F75 MANIFOLD MP	759.55
531AEC-FBQ-D	530AEC FLOWBACK QC MANIFOLD	372.09	532AEC-3Q-D	530AEC 3-WAY QC MANIFOLD	802.36
			532AEC-3Q-P	530AEC 3-WAY QC MANIFOLD MP	759.55
			532AEC-FB-D	530AEC FLOWBACK LQC MANIFOLD	680.84

PART NO.	DESCRIPTION	U.S.DOLLARS
532AEC-FB-P	530AEC FLOWBACK LQC MANIFOLD MP	638.02
532AEC-FBF50-D	530AEC FLOWBACK F50 MANIFOLD	680.84
532AEC-FBF50-P	530AEC FLOWBACK F50 MANIFOLD MP	638.02
532AEC-FBF75-D	530AEC FLOWBACK F75 MANIFOLD	680.84
532AEC-FBF75-P	530AEC FLOWBACK F75 MANIFOLD MP	638.02
532AEC-FBQ-D	530AEC FLOWBACK QC MANIFOLD	680.84
532AEC-FBQ-P	530AEC FLOWBACK QC MANIFOLD MP	638.02
532AM-2	530AM MANUAL 2-WAY PLUNGER VALVE ASSEMBLY	145.93
532AM-2F50	530AM MANUAL 2-WAY PLUNGER VALVE ASSEMBLY F50	145.93
532AM-2F75	530AM MANUAL 2-WAY PLUNGER VALVE ASSEMBLY F75	145.93
532AM-2Q	530AM MANUAL 2-WAY PLUNGER VALVE ASSEMBLY QC	145.93
532AM-3	530AM MANUAL 3-WAY PLUNGER VALVE ASSEMBLY	231.92
533AE-2-D	530AE 2-WAY LQC MANIFOLD	907.26
533AE-2-P	530AE 2-WAY LQC MANIFOLD MP	843.05
533AE-2F50-D	530AE 2-WAY F50 MANIFOLD	907.26
533AE-2F50-P	530AE 2-WAY F50 MANIFOLD MP	843.05
533AE-2F75-D	530AE 2-WAY F75 MANIFOLD	907.26
533AE-2F75-P	530AE 2-WAY F75 MANIFOLD MP	843.05
533AE-2Q-D	530AE 2-WAY QC MANIFOLD	907.26
533AE-2Q-P	530AE 2-WAY QC MANIFOLD MP	843.05
533AE-3-D	530AE 3-WAY LQC MANIFOLD	1170.51
533AE-3-P	530AE 3-WAY LQC MANIFOLD MP	1106.29
533AE-3F50-D	530AE 3-WAY F50 MANIFOLD	1170.51
533AE-3F50-P	530AE 3-WAY F50 MANIFOLD MP	1106.29
533AE-3F75-D	530AE 3-WAY F75 MANIFOLD	1170.51
533AE-3F75-P	530AE 3-WAY F75 MANIFOLD MP	1106.29
533AE-3Q-D	530AE 3-WAY QC MANIFOLD	1170.51
533AE-3Q-P	530AE 3-WAY QC MANIFOLD MP	1106.29
533AE-FB-D	530AE FLOWBACK LQC MANIFOLD	989.95
533AE-FB-P	530AE FLOWBACK LQC MANIFOLD MP	925.73
533AE-FBF50-D	530AE FLOWBACK F50 MANIFOLD	989.95
533AE-FBF50-P	530AE FLOWBACK F50 MANIFOLD MP	925.73
533AE-FBF75-D	530AE FLOWBACK F75 MANIFOLD	989.95
533AE-FBF75-P	530AE FLOWBACK F75 MANIFOLD MP	925.73
533AE-FBQ-D	530AE FLOWBACK QC MANIFOLD	989.95
533AE-FBQ-P	530AE FLOWBACK QC MANIFOLD MP	925.73
533AEC-2-D	530AEC 2-WAY LQC MANIFOLD	907.26
533AEC-2-P	530AEC 2-WAY LQC MANIFOLD MP	843.05
533AEC-2F50-D	530AEC 2-WAY F50 MANIFOLD	907.26
533AEC-2F50-P	530AEC 2-WAY F50 MANIFOLD MP	843.05
533AEC-2F75-D	530AEC 2-WAY F75 MANIFOLD	907.26
533AEC-2F75-P	530AEC 2-WAY F75 MANIFOLD MP	843.05
533AEC-2Q-D	530AEC 2-WAY QC MANIFOLD	907.26
533AEC-2Q-P	530AEC 2-WAY QC MANIFOLD MP	843.05

PART NO.	DESCRIPTION	U.S.DOLLARS
533AEC-3-D	530AEC 3-WAY LQC MANIFOLD	1170.51
533AEC-3-P	530AEC 3-WAY LQC MANIFOLD MP	1106.29
533AEC-3F50-D	530AEC 3-WAY F50 MANIFOLD	1170.51
533AEC-3F50-P	530AEC 3-WAY F50 MANIFOLD MP	1106.29
533AEC-3F75-D	530AEC 3-WAY F75 MANIFOLD	1170.51
533AEC-3F75-P	530AEC 3-WAY F75 MANIFOLD MP	1106.29
533AEC-3Q-D	530AEC 3-WAY QC MANIFOLD	1170.51
533AEC-3Q-P	530AEC 3-WAY QC MANIFOLD MP	1106.29
533AEC-FB-D	530AEC FLOWBACK LQC MANIFOLD	989.95
533AEC-FB-P	530AEC FLOWBACK LQC MANIFOLD MP	925.73
533AEC-FBF50-D	530AEC FLOWBACK F50 MANIFOLD	989.95
533AEC-FBF50-P	530AEC FLOWBACK F50 MANIFOLD MP	925.73
533AEC-FBF75-D	530AEC FLOWBACK F75 MANIFOLD	989.95
533AEC-FBF75-P	530AEC FLOWBACK F75 MANIFOLD MP	925.73
533AEC-FBQ-D	530AEC FLOWBACK QC MANIFOLD	989.95
533AEC-FBQ-P	530AEC FLOWBACK QC MANIFOLD MP	925.73
533AM-2	530AM MANUAL 2-WAY PLUNGER VALVE ASSEMBLY	187.94
533AM-2F50	530AM MANUAL 2-WAY PLUNGER VALVE ASSEMBLY F50	187.94
533AM-2F75	530AM MANUAL 2-WAY PLUNGER VALVE ASSEMBLY F75	187.94
533AM-2Q	530AM MANUAL 2-WAY PLUNGER VALVE ASSEMBLY QC	187.92
533EC-3-P	530EC 3-WAY LQC MANIFOLD MP	1106.30
534AE-2-D	530AE 2-WAY LQC MANIFOLD	1212.68
534AE-2-P	530AE 2-WAY LQC MANIFOLD MP	1127.05
534AE-2F50-D	530AE 2-WAY F50 MANIFOLD	1212.68
534AE-2F50-P	530AE 2-WAY F50 MANIFOLD MP	1127.05
534AE-2F75-D	530AE 2-WAY F75 MANIFOLD	1212.68
534AE-2F75-P	530AE 2-WAY F75 MANIFOLD MP	1127.05
534AE-2Q-D	530AE 2-WAY QC MANIFOLD	1212.68
534AE-2Q-P	530AE 2-WAY QC MANIFOLD MP	1127.05
534AE-3-D	530AE 3-WAY LQC MANIFOLD	1566.18
534AE-3-P	530AE 3-WAY LQC MANIFOLD MP	1480.56
534AE-3F50-D	530AE 3-WAY F50 MANIFOLD	1566.18
534AE-3F50-P	530AE 3-WAY F50 MANIFOLD MP	1480.56
534AE-3F75-D	530AE 3-WAY F75 MANIFOLD	1566.18
534AE-3F75-P	530AE 3-WAY F75 MANIFOLD MP	1480.56
534AE-3Q-D	530AE 3-WAY QC MANIFOLD	1566.18
534AE-3Q-P	530AE 3-WAY QC MANIFOLD MP	1480.56
534AE-FB-D	530AE FLOWBACK LQC MANIFOLD	1319.85
534AE-FB-P	530AE FLOWBACK LQC MANIFOLD MP	1234.22
534AE-FBF50-D	530AE FLOWBACK F50 MANIFOLD	1319.85
534AE-FBF50-P	530AE FLOWBACK F50 MANIFOLD MP	1234.22
534AE-FBF75-D	530AE FLOWBACK F75 MANIFOLD	1319.85
534AE-FBF75-P	530AE FLOWBACK F75 MANIFOLD MP	1234.22
534AE-FBQ-D	530AE FLOWBACK QC MANIFOLD	1319.85



PART NO.	DESCRIPTION	U.S.DOLLARS	PART NO.	DESCRIPTION	U.S.DOLLARS
534AE-FBQ-P	530AE FLOWBACK QC MANIFOLD MP	1234.22	535AE-FB-D	530AE FLOWBACK LQC MANIFOLD	1649.91
534AEC-2-D	530AEC 2-WAY LQC MANIFOLD	1212.68	535AE-FB-P	530AE FLOWBACK LQC MANIFOLD MP	1542.89
534AEC-2-P	530AEC 2-WAY LQC MANIFOLD MP	1127.05	535AE-FBF50-D	530AE FLOWBACK F50 MANIFOLD	1649.91
534AEC-2F50-D	530AEC 2-WAY F50 MANIFOLD	1212.68	535AE-FBF50-P	530AE FLOWBACK F50 MANIFOLD MP	1542.89
534AEC-2F50-P	530AEC 2-WAY F50 MANIFOLD MP	1127.05	535AE-FBF75-D	530AE FLOWBACK F75 MANIFOLD	1649.91
534AEC-2F75-D	530AEC 2-WAY F75 MANIFOLD	1212.68	535AE-FBF75-P	530AE FLOWBACK F75 MANIFOLD MP	1542.89
534AEC-2F75-P	530AEC 2-WAY F75 MANIFOLD MP	1127.05	535AE-FBQ-D	530AE FLOWBACK QC MANIFOLD	1649.91
534AEC-2Q-D	530AEC 2-WAY QC MANIFOLD	1212.68	535AE-FBQ-P	530AE FLOWBACK QC MANIFOLD MP	1542.89
534AEC-2Q-P	530AEC 2-WAY QC MANIFOLD MP	1127.05	535AEC-2-D	530AEC 2-WAY LQC MANIFOLD	1515.87
534AEC-3-D	530AEC 3-WAY LQC MANIFOLD	1566.18	535AEC-2-P	530AEC 2-WAY LQC MANIFOLD MP	1408.84
534AEC-3-P	530AEC 3-WAY LQC MANIFOLD MP	1480.56	535AEC-2F50-D	530AEC 2-WAY F50 MANIFOLD	1515.87
534AEC-3F50-D	530AEC 3-WAY F50 MANIFOLD	1566.18	535AEC-2F50-P	530AEC 2-WAY F50 MANIFOLD MP	1408.84
534AEC-3F50-P	530AEC 3-WAY F50 MANIFOLD MP	1480.56	535AEC-2F75-D	530AEC 2-WAY F75 MANIFOLD	1515.87
534AEC-3F75-D	530AEC 3-WAY F75 MANIFOLD	1566.18	535AEC-2F75-P	530AEC 2-WAY F75 MANIFOLD MP	1408.84
534AEC-3F75-P	530AEC 3-WAY F75 MANIFOLD MP	1480.56	535AEC-2Q-D	530AEC 2-WAY QC MANIFOLD	1515.87
534AEC-3Q-D	530AEC 3-WAY QC MANIFOLD	1566.18	535AEC-2Q-P	530AEC 2-WAY QC MANIFOLD MP	1408.84
534AEC-3Q-P	530AEC 3-WAY QC MANIFOLD MP	1480.56	535AEC-3-D	530AEC 3-WAY LQC MANIFOLD	1976.20
534AEC-FB-D	530AEC FLOWBACK LQC MANIFOLD	1319.85	535AEC-3-P	530AEC 3-WAY LQC MANIFOLD MP	1869.19
534AEC-FB-P	530AEC FLOWBACK LQC MANIFOLD MP	1234.22	535AEC-3F50-D	530AEC 3-WAY F50 MANIFOLD	1976.20
534AEC-FBF50-D	530AEC FLOWBACK F50 MANIFOLD	1319.85	535AEC-3F50-P	530AEC 3-WAY F50 MANIFOLD MP	1869.19
534AEC-FBF50-P	530AEC FLOWBACK F50 MANIFOLD MP	1234.22	535AEC-3F75-D	530AEC 3-WAY F75 MANIFOLD	1976.20
534AEC-FBF75-D	530AEC FLOWBACK F75 MANIFOLD	1319.85	535AEC-3F75-P	530AEC 3-WAY F75 MANIFOLD MP	1869.19
534AEC-FBF75-P	530AEC FLOWBACK F75 MANIFOLD MP	1234.22	535AEC-3Q-D	530AEC 3-WAY QC MANIFOLD	1976.20
534AEC-FBQ-D	530AEC FLOWBACK QC MANIFOLD	1319.85	535AEC-3Q-P	530AEC 3-WAY QC MANIFOLD MP	1869.19
534AEC-FBQ-P	530AEC FLOWBACK QC MANIFOLD MP	1234.22	535AEC-FB-D	530AEC FLOWBACK LQC MANIFOLD	1649.91
534AM-2	530AM MANUAL 2-WAY PLUNGER VALVE ASSEMBLY	229.94	535AEC-FB-P	530AEC FLOWBACK LQC MANIFOLD MP	1542.89
534AM-2F50	530AM MANUAL 2-WAY PLUNGER VALVE ASSEMBLY F50	229.94	535AEC-FBF50-D	530AEC FLOWBACK F50 MANIFOLD	1649.91
534AM-2F75	530AM MANUAL 2-WAY PLUNGER VALVE ASSEMBLY F75	229.94	535AEC-FBF50-P	530AEC FLOWBACK F50 MANIFOLD MP	1542.89
534AM-2Q	530AM MANUAL 2-WAY PLUNGER VALVE ASSEMBLY QC	229.94	535AEC-FBF75-D	530AEC FLOWBACK F75 MANIFOLD	1649.91
535AE-2-D	530AE 2-WAY LQC MANIFOLD	1515.87	535AEC-FBF75-P	530AEC FLOWBACK F75 MANIFOLD MP	1542.89
535AE-2-P	530AE 2-WAY LQC MANIFOLD MP	1408.84	535AEC-FBQ-D	530AEC FLOWBACK QC MANIFOLD	1649.91
535AE-2F50-D	530AE 2-WAY F50 MANIFOLD	1515.87	535AEC-FBQ-P	530AEC FLOWBACK QC MANIFOLD MP	1542.89
535AE-2F50-P	530AE 2-WAY F50 MANIFOLD MP	1408.84	535AM-2	530AM MANUAL 2-WAY PLUNGER VALVE ASSEMBLY	271.94
535AE-2F75-D	530AE 2-WAY F75 MANIFOLD	1515.87	535AM-2F50	530AM MANUAL 2-WAY PLUNGER VALVE ASSEMBLY F50	271.94
535AE-2F75-P	530AE 2-WAY F75 MANIFOLD MP	1408.84	535AM-2F75	530AM MANUAL 2-WAY PLUNGER VALVE ASSEMBLY F75	271.94
535AE-2Q-D	530AE 2-WAY QC MANIFOLD	1515.87	535AM-2Q	530AM MANUAL 2-WAY PLUNGER VALVE ASSEMBLY QC	271.94
535AE-2Q-P	530AE 2-WAY QC MANIFOLD MP	1408.84	536AM-2	530AM MANUAL 2-WAY PLUNGER VALVE ASSEMBLY	313.97
535AE-3-D	530AE 3-WAY LQC MANIFOLD	1976.20	536AM-2F50	530AM MANUAL 2-WAY PLUNGER VALVE ASSEMBLY F50	313.97
535AE-3-P	530AE 3-WAY LQC MANIFOLD MP	1869.19			
535AE-3F50-D	530AE 3-WAY F50 MANIFOLD	1976.20			
535AE-3F50-P	530AE 3-WAY F50 MANIFOLD MP	1869.19			
535AE-3F75-D	530AE 3-WAY F75 MANIFOLD	1976.20			
535AE-3F75-P	530AE 3-WAY F75 MANIFOLD MP	1869.19			
535AE-3Q-D	530AE 3-WAY QC MANIFOLD	1976.20			
535AE-3Q-P	530AE 3-WAY QC MANIFOLD MP	1869.19			

PART NO.	DESCRIPTION	U.S.DOLLARS	PART NO.	DESCRIPTION	U.S.DOLLARS
536AM-2F75	530AM MANUAL 2-WAY PLUNGER VALVE ASSEMBLY F75	313.97	5500-SS-Y1	ADJ.CONEJET TIP SS	157.46
537AM-2	530AM MANUAL 2-WAY PLUNGER VALVE ASSEMBLY	355.99	5500-SS-Y18	ADJ.CONEJET TIP,SS.	157.46
537AM-2F50	530AM MANUAL 2-WAY PLUNGER VALVE ASSEMBLY F50	355.99	5500-X.60	ADJ.CONEJET TIP,BR.	29.11
537AM-2F75	530AM MANUAL 2-WAY PLUNGER VALVE ASSEMBLY F75	355.99	5500-X1	ADJ.CONEJET TIP,BR.	29.11
538AM-2	530AM MANUAL 2-WAY PLUNGER VALVE ASSEMBLY	397.99	5500-X10	ADJ.CONEJET TIP,BR.	29.11
538AM-2F50	530AM MANUAL 2-WAY PLUNGER VALVE ASSEMBLY F50	397.99	5500-X12	ADJ.CONEJET TIP,BR.	29.11
538AM-2F75	530AM MANUAL 2-WAY PLUNGER VALVE ASSEMBLY F75	397.99	5500-X14	ADJ.CONEJET TIP,BR.	29.11
539AM-2	530AM MANUAL 2-WAY PLUNGER VALVE ASSEMBLY	439.99	5500-X18	ADJ.CONEJET TIP,BR,CAP	29.11
539AM-2F50	530AM MANUAL 2-WAY PLUNGER VALVE ASSEMBLY F50	439.99	5500-X2	ADJ.CONEJET TIP,BR.	29.11
539AM-2F75	530AM MANUAL 2-WAY PLUNGER VALVE ASSEMBLY F75	439.99	5500-X22	ADJ.CONEJET TIP,BR.	29.11
541EC-2	540 MANIFOLD	442.65	5500-X26	ADJ.CONEJET TIP,BR.	29.11
542E-2	540 MANIFOLD	901.79	5500-X3	ADJ.CONEJET TIP,BR.	29.11
542EC-2	540 MANIFOLD	901.79	5500-X4	ADJ.CONEJET TIP,BR.	29.11
5430-3/4-2TOC06	BOOMJET NOZ,BRASS	343.23	5500-X5	ADJ.CONEJET TIP,BR.	29.11
5430-3/4-2TOC10	BOOMJET NOZ,BRASS	343.23	5500-X6	ADJ.CONEJET TIP,BR.	29.11
5430-3/4-2TOC20	BOOMJET NOZ,BRASS	343.23	5500-X8	ADJ.CONEJET TIP,BR.	29.11
5430-3/4-2TOC30	BOOMJET NOZ,BRASS	343.23	5500-Y1	ADJ.CONEJET TIP,BR.	42.59
5430-3/4-2TOC40	BOOMJET NOZ,BRASS	343.23	5500-Y2	ADJ.CONEJET TIP,BR.	42.59
5430-3/4-2TOC80	BOOMJET NOZ,BRASS	343.23	5500-Y3	ADJ.CONEJET TIP BR.	42.59
543E-2	540 MANIFOLD	1360.97	5500-Y5	ADJ.CONEJET TIP,BR.	42.59
543EC-2	540 MANIFOLD	1360.97	55140-30L-1/4	GUNJET SPRAY GUN	93.60
544E-2	540 MANIFOLD	1820.19	55140-30L-1/4-VI	GUNJET SPRAY GUN	102.09
544EC-2	540 MANIFOLD	1820.19	55215-100-EPR	XRC/AIC TIP STRAINER 100 MESH GREEN, EPDM- W/GASKET	2.51
545E-2	540 MANIFOLD	2279.32	55215-100-VI	XRC/AIC TIP STRAINER 100 MESH GREEN W/VITON GASKET	4.88
545EC-2	540 MANIFOLD	2279.32	55215-50-EPR	XRC/AIC TIP STRAINER 50 MESH BLUE BODY, EPDM W/GASKET	2.51
545EC-2-OB	540 MANIFOLD	2388.81	55215-50-VI	XRC/AIC TIP STRAINER 50 MESH BLUE BODY W/VITON GASKET	4.88
5500-BR/SS-X1	ADJ CONJET BRASS/SS	34.63	55225-1-126MLSC-3	3/4" SC LESS SCREEN	45.75
5500-BR/SS-X10	ADJ CONJET BRASS/SS	34.63	55225-1-126MLSC-4	1" SC LESS SCREEN	45.75
5500-BR/SS-X2	ADJ CONJET BRASS/SS	34.63	55225-1-126MLSC-F50	FLNG SC LESS SCREEN	45.75
5500-BR/SS-X3	ADJ CONJET BRASS/SS	34.63	55226-1-126MLSC-5	1-1/4 SC LESS SCREEN	74.49
5500-BR/SS-X5	ADJ CONEJET BRASS/SS	34.63	55226-1-126MLSC-6	1-1/2 SC LESS SCREEN	74.49
5500-BR/SS-X6	ADJ CONEJET BRASS/SS	34.63	55226-1-126MLSC-F75	FLNG SC LESS SCREEN	74.49
5500-BR/SS-X8	ADJ CONJET BRASS/SS	34.63	55240-CELR	HARDI QJ ADAPTER	4.14
5500-PPB-X12	ADJ.CONEJET TIP,PP	13.30	55245-50	50 SERIES CLAMP ASSY	16.81
5500-PPB-X12-VI	ADJ.CONEJET TIP,PP	15.24	55245-75	75 SERIES CLAMP ASSY	17.21
5500-PPB-X14	ADJ.CONEJET TIP,PP	13.30	55248-05-AMP	3-WIRE METRI-PACK CABLE, 0.5M	44.70
5500-PPB-X14-VI	ADJ.CONEJET TIP,PP	15.24	55270-1/2-11-POM	TANK RINSING NOZZLE	124.66
5500-PPB-X18	ADJ.CONEJET TIP,PP	13.30	55270-3/4-18-POM	TANK RINSING NOZZLE	124.66
5500-PPB-X18-VI	ADJ.CONEJET TIP,PP	15.24	55300	AIR CHEMSAVER	55.10
5500-PPB-X22	ADJ CONEJET TIP,PP	13.30	55300-1	QJS AIR CHEMSAVER	55.10
5500-PPB-X22-VI	ADJ CONEJET TIP,PP	15.24	55309-TTJ60-11003VP	VISIFLO TWINJET W/QT EXTENSION CAP	20.02
5500-PPB-X3	ADJ.CONEJET TIP,PP	13.30	55309-TTJ60-11004VP	VISIFLO TWINJET W/QT EXTENSION CAP	20.02
5500-PPB-X3-VI	ADJ.CONEJET TIP,PP	15.24	55309-TTJ60-11005VP	VISIFLO TWINJET W/QT EXTENSION CAP	20.02
5500-PPB-X5	ADJ.CONEJET TIP,PP	13.30	55309-TTJ60-11006VP	VISIFLO TWINJET W/QT EXTENSION CAP	20.02
5500-PPB-X5-VI	ADJ.CONEJET TIP,PP	15.24	55310-AITTJ60-11003VP	VISIFLO AI TWINJET W/QT EXTENSION CAP	19.95
5500-PPB-X6	ADJ.CONEJET TIP,PP	13.30	55310-AITTJ60-11004VP	VISIFLO AI TWINJET W/QT EXTENSION CAP	19.95
5500-PPB-X6-VI	ADJ.CONEJET TIP,PP	15.24	55310-AITTJ60-11005VP	VISIFLO AI TWINJET W/QT EXTENSION CAP	19.95
5500-PPB-X8	ADJ.CONEJET TIP,PP	13.30	55310-AITTJ60-11006VP	VISIFLO AI TWINJET W/QT EXTENSION CAP	19.95
5500-PPB-X8-VI	ADJ.CONEJET TIP,PP	15.24	5540-1/4TT	TEEJET SW.BDY ASB,BR	29.36
5500-SS-X1	ADJ.CONEJET TIP,SS.	154.36	56600-11-23-C	BALL VALVE ASSEMBLY	461.07
5500-SS-X12	ADJ.CONEJET TIP,SS.	157.46	56600-11-23-C15	BALL VALVE ASSEMBLY	475.42
5500-SS-X18	ADJ.CONEJET TIP,SS.	157.46	56600-11-23-CN	BALL VALVE ASSEMBLY	461.07
5500-SS-X26	ADJ.CONEJET TIP,SS.	157.46	56600-11-23S-C	BALL VALVE ASSEMBLY	583.62
5500-SS-X3	ADJ.CONEJET TIP,SS.	157.46			
5500-SS-X8	ADJ.CONEJET TIP,SS.	157.46			

PART NO.	DESCRIPTION	U.S.DOLLARS	PART NO.	DESCRIPTION	U.S.DOLLARS
56600-11-24-C	BALL VALVE ASSEMBLY	461.07	56601-3-1-SS	RPL/ASB 344B34 L/MTR SS	517.55
56600-11-24-C15	BALL VALVE ASSEMBLY	475.42	56601-3-3/4	RPL/ASB 344B33 L/MTR	395.01
56600-11-24-CN	BALL VALVE ASSEMBLY	461.07	56601-3-3/4-SS	RPL/ASB 344B33 L/MTR SS	517.55
56600-11-24-CVX	344B NORM OPEN	479.73	56601-3-F	RPL/ASB 344B3F L/MTR	395.01
56600-11-24-D	BALL VALVE ASSEMBLY	461.07	56601-3-F-SS	RPL/ASB 344B3Q L/MTR SS	517.55
56600-11-24-P	BALL VALVE ASSEMBLY LESS CABLE	439.66	56601-3-Q	RPL/ASB 344B3Q L/MTR	395.01
56600-11-24S-C	344B NORM 1"	575.00	56601-3-Q-SS	RPL/ASB 344B3Q L/MTR SS	517.55
56600-11-24S-CJ	344B NORM 1"	609.05	56601-3PR-1	RPL/ASB 344BPR L/MTR	407.45
56600-11-24S-CVX	344B NORM OPEN 1" SS	593.64	56601-3PR-3/4	RPL/ASM 344BPR L/MTR	322.75
56600-11-2F-C	NORM OPEN BALL VALVE ASSEMBLY	461.07	56601-8	RPL/ASB 344B-2 4/Q L/MTR	445.31
56600-11-2FS-CVX	344B NORM OPEN 50F	605.52	56601-9	RPL/ASB 344B-3 Q/Q/4 L/MTR	517.55
56600-11-2FS-D	344B NORM OPEN 50F	583.62	56602-10-346BE	346 BALL VALVE SPECIAL	916.14
56600-11-33-C	344B NORM OPEN 3/4"	564.25	56602-11-25-D	346B NORM OPEN 1-1/4	859.91
56600-11-33-D	BALL VALVE ASSEMBLY	564.25	56602-11-25S-C	346B NORM OPEN 1-1/4 SS	1001.23
56600-11-34-C	BALL VALVE ASSEMBLY	564.25	56602-11-25S-C15	346B NORM OPEN 1-1/4 SS	1030.61
56600-11-3F-DN	BALL VALVE ASSEMBLY	564.25	56602-11-26-C	346B NORM OPEN 1-1/2	859.91
56600-11-3FS-C03OG	344B NORM OPEN F50 SS	708.88	56602-11-26-C15	346B NORM OPEN 1-1/2	874.33
56600-11-BQ-D	NORM OPEN BY-PASS	461.07	56602-11-26-D	346B NORM OPEN 1-1/2	859.91
56600-14-23-01C60	344BRL 90DGREE 18SEC	527.42	56602-11-2F75-C	346 NORM OPEN F75	859.91
56600-14-23-03C60	344BRL 90DEGREE 6SEC	527.42	56602-11-2F75-D	346B NORM OPEN F75	859.91
56600-14-23-06C60	344BRL 90DEGREE 3SEC	527.42	56602-11-2F75-P	346 NORM OPEN F75	838.49
56600-15-344BEC	2F & Q SS DIN	686.89	56602-11-36-C	346B NORM OPEN 1-1/2	847.19
56600-2-344BEC	NORMAL OPEN 344BEC	461.07	56602-11-36-C15	346B NORM OPEN 1-1/2	861.61
56600-22-PP	344-3FB-PP SPECIAL	4468.50	56602-11-36-D	346B NORM OPEN 1-1/2	847.19
56600-22-SS	344-3FB-SS SPECIAL	5430.08	56602-11-3F-DN	346B NORM OPEN 50F	859.91
56600-23-344BEC-3S	344 BALL VALVE SPECIAL, SS	708.83	56602-11-3F75-CVX	346B NORM OPEN F75	881.81
56600-25-344BE	BALL VALVE ASSEMBLY	587.48	56602-11-3F75-D	NORMALLY OPEN 346BEC	847.19
56600-25-344BEC	BALL VALVE ASSEMBLY	587.48	56602-11-3F75-DN	346 NORM OPEN F75	847.19
56600-26-344BRL	BALL VALVE ASSEMBLY	526.27	56602-12	346 MANIFOLD SPECIAL	2199.11
56600-3-344BEC-CPC	NORMAL OPEN 344BEC	482.97	56602-14-B346BR	REG MANIFOLD SPECIAL	1201.81
56600-30-344BEC	344 BALL VALVE SPECIAL	482.97	56602-15-B346BR	REG MANIFOLD SPECIAL	1188.19
56600-32-344BE	344 BALL VALVE SPECIAL	486.84	56602-16	346BR-346BEC N.O. REG MNLD W/STRAINER	2226.66
56600-33	FLOW CONTROL MANIFOLD SPECIAL	1477.84	56602-17	346BR-346BEC N.O. REG MNLD	2190.85
56600-35-344BE-2FS	BALL VALVE ASSEMBLY	1371.00	56602-18-346BEC-2F75-D	346 SHUT OFF MANIFOLD	2881.52
56600-4-344BE	344 BALL VALVE SPECIAL	1564.50	56602-2	346MANIFOLD SHUTOFF/BYPASS 1-1/2 & F75	859.91
56600-4-344BEC	344 BALL VALVE SPECIAL	1564.50	56602-20-346BPR-03C05EC	REG VALVE SPECIAL BPR	1057.06
56600-42-344BEC/344BR	344 REG/SHUTOFF MNFD	1345.79	56602-21-346BPR-03CGC	346 BPR VALVE SPECIAL	1013.83
56600-45-344BEC-2F-C	344 BALL VALVE SPECIAL	461.07	56602-21-346BPR-SS	3RPM 12SEC REG 1-1/2 -SS BALL	1099.35
56600-45-344BEC-33-CPC	344 BALL VALVE SPECIAL	586.23	56602-23-346BEC-36-D	SHUTOFF/BYPASS 1-1/2 W/ 22 RPM MOTOR	859.91
56600-5-B344BRL	BALL VALVE SPECIAL	473.85	56602-24-346/344BE	346/344BE REG MANIFOLD	1760.33
56600-51-344BEC-2	SHUT OFF BALL VALVE ASB	439.66	56602-25-346/344BEC	346/344BEC REG MANIFOLD	1760.33
56601-2-0	RPL/ASB 344B-2 L/MTR	262.66	56602-26-346BPR	346BPR/BEC ASSY	2658.63
56601-2-1	RPL/ASB 344B24 L/MTR	322.75	56602-27-346BEC	346BEC NO ASSEMBLY	1042.91
56601-2-1-SS	RPL/ASB 344B24 L/MTR	445.31	56602-28-346BEC/346BR	REG MANIFOLD SPECIAL	3566.22
56601-2-3/4	RPL/ASB 344B23 L/MTR	322.75	56602-30-346BE-D	REG MANIFOLD SPEC	859.91
56601-2-3/4-SS	RPL/ASB 344B2F L/MTR	445.31	56602-30-346BEC-D	REG MANIFOLD SPEC	859.91
56601-2-F	RPL/ASB 344B2F L/MTR	322.75	56602-30-B346BE-D	REG MANIFOLD SPEC	859.91
56601-2-F-SS	RPL/ASB 344B2F L/MTR	445.31	56602-30-B346BEC-D	REG MANIFOLD SPEC	859.91
56601-2-Q	RPL/ASB 344B2Q L/MTR	322.75	56602-34-346BEC/346BR	REG MANIFOLD SPECIAL	3530.14
56601-2-Q-SS	RPL/ASB 344B2Q SS L/MTR	445.31	56602-36-346BPR/346BEC	REG MANIFOLD SPEC	2095.27
56601-2PR-1	RPL/ASB 344BPR L/MTR	322.75	56602-37-346BPR/346BE	REG MANIFOLD SPEC	2095.27
56601-2PR-3/4	RPL/ASB 344BPR L/MTR	322.75	56602-39-346BEC/346BR	REG MANIFOLD SPECIAL	3377.37
56601-2PR-F	RPL/ASB 344BPR L/MTR	322.75	56602-42-346BR/346BEC	REG MANIFOLD SPECIAL	2130.23
56601-2RL-1	344BRL SUB ASB 1"	322.75	56602-5	346BR/BEC ASSY	1919.88
56601-2RL-1-SS	344BRL SUB ASB 1 INCH	445.31	56602-8-346BR	346BR/BEC ASSY	2030.57
56601-2RL-3/4	344BRL SUB ASB 3/4	322.75	56602-9	REG VALVE MNFD	1204.97
56601-2RL-F	344BRL SUB ASB F50	322.75	56603-1	346BPR SUB-ASSEMBLY SPECIAL	623.96
56601-2RL-F-SS	344BRL SUB ASB FLANG	445.31	56603-1-SS	REG VALVE SUB ASSEMBLY	662.82
56601-2RL-Q	344BRL SUB ASB QC	322.75	56603-2-0	RPL/BDY 346B-2	623.96
56601-3-1	RPL/ASB 344B34 L/MTR	395.01	56603-2-0-SS	RPL/BDY 346B-2 SS	816.85
56601-3-1-0-SS	RPL/ASB 344B24 L/MTR	457.33	56603-2-11/2	RPL/ASB 346B26 L/MTR	623.96



# COMPREHENSIVE LIST

PART NO.	DESCRIPTION	U.S.DOLLARS	PART NO.	DESCRIPTION	U.S.DOLLARS
56603-2-11/2-SS	RPL/ASB 346B26 SS	816.85	56608-6-453BEC	450 MANIFOLD	1907.19
56603-2-11/4	RPL/ASB 346B25 L/MTR	623.96	56608-66-B451BE-2N4S	450N MANIFOLD SS BALL MTR ROTATED	609.65
56603-2-11/4-SS	RPLASB 346B25 L/MTR	816.85	56608-66-B452BE-2N4S	450N MANIFOLD SS BALL MTR ROTATED	1248.95
56603-2-F	RPL/ASB 346B2F L/MTR	623.96	56608-66-B453BE-2N4S	450N MANIFOLD SS BALL MTR ROTATED	1888.07
56603-2-F-SS	RPLASB 346B2FS L/MTR	816.85	56608-66-B454BE-2N4S	450N MANIFOLD SS BALL MTR ROTATED	2527.22
56603-2-F75	RPL/ASB 346B2F75	623.96	56608-66-B455BE-2N4S	450N MANIFOLD SS BALL MTR ROTATED	3166.58
56603-2-F75-SS	RPL/ASB 346B2F75 SS	816.85	56608-7-451BEC	450 MANIFOLD	521.09
56603-3	346 F75 SUB ASSEMBLY	700.48	56608-7-452BEC	450 MANIFOLD	1032.60
56603-3-11/2	RPL/ASB 346B36 L/MTR	623.96	56608-7-453BEC	450 MANIFOLD	1544.11
56603-3-11/4	RPL/ASB 346B35 L/MTR	623.96	56608-7-454BEC	450 MANIFOLD	2055.65
56603-3-F	RPL/ASB 346B3F L/MTR	623.96	56608-7-455BEC	450 MANIFOLD	2567.21
56603-3-F75	RPL/ASB 346B3F75	623.96	56608-8-453BEC	450 MANIFOLD	1544.11
56603-3PR-11/2	RPL/ASB 346B36 L/MTR	617.78	56608-8-455BEC	450 MANIFOLD	2567.21
56603-3PR-11/4	RPL/ASB 346B36 L/MTR	617.78	56609-2-1	450 VLV SUB/ASB 1"	330.89
56603-3PR-F	RPL/ASB 346BPR L/MTR	617.78	56609-2-3/4	450 VLV SUB/ASB 3/4"	330.89
56603-3PR-F75	RPL/ASB 346BPR L/MTR	617.78	56609-2-3/4-S	450 VLV SUB/ASB 3/4" SS	453.46
56604-11-C	356 NORMALLY OPEN	619.89	56609-2-F	450 SUB/ASB FLANGE	330.89
56604-11-C15TU	356 NORMALLY OPEN	656.27	56609-2-F-S	450 SUB/ASB FLANGE SS	453.46
56604-11-CPB	356 NORMALLY OPEN	641.78	56609-2-Q	450 VLV SUB/ASB QC	330.89
56604-11-D	VALVE NORMALLY OPEN	619.89	56609-2-Q-SS	450 VLV SUB/ASB QC SS	453.46
56605	356 TRUN VLV BODY	425.30	56609-2N-1	450 N SUB/ASB 1"	330.89
56606-1-442BEC	BALL VALVE MANIFOLD	1112.67	56609-2N-1-SS	450 VLV SUB-ASB 1" SS	444.56
56606-1-443BEC	BALL VALVE MANIFOLD	1656.90	56609-2N-3/4	450 N SUB/ASB 3/4"	330.89
56606-1-445BEC	BALL VALVE MANIFOLD	2735.76	56609-2N-F	450 SUB/ASB FLANGE SS	330.89
56606-11	REG/BYPASS 440 BSPT EC	1185.33	56609-2N-Q	450 N SUB/ASB QC	330.89
56606-13-440	440 MANIFOLD	1112.67	56609-2NF-SS	450 N SUB/ASB FLANGE SS BALL	453.46
56606-2-443BEC	440 MANIFOLD	1729.78	56609-2NRL-F	2-WAY RL VALVE SUB ASSM	372.63
56606-3-440B	440 REG/BYPASS BSPT	1450.60	56609-2NRL-Q	2-WAY RL VALVE SUB ASSM	372.63
56606-7-440B	NEG/BYPASS 440 QC	1337.18	56609-2RL-F	2-WAY RL VALVE SUB ASSM	372.63
56606-9-440B	REG/BYPASS 440 BSPT	1185.33	56609-2RL-Q	2-WAY RL VALVE SUB ASSM	372.63
56607-2-1	440 BODY SUB/ASB	336.51	56609-3FB-1	450 FB VLV SUB ASB	394.66
56607-2-1-SS	440 VALVE SUB/ASB 1" SS	459.06	56609-3FB-F	450 FB VLV SUB ASB	394.66
56607-2-3/4	440 VLV SUB ASB 3/4	336.51	56609-3FB-F-SS	450 FB VLV SUB/ASB	458.43
56607-2-3/4-SS	440 VALVE SUB/ASB 3/4" SS	459.06	56609-3FB-Q	450 FB VLV SUB ASB	394.66
56607-2-F	440 BUB/ASB FLANGE	336.51	56610-10-462BEC	460 BALL VALVES	1286.24
56607-2-F-SS	440 VALVE SUB/ASB 50F SS	459.06	56610-10-466BEC	460 MANIFOLD	3658.82
56607-2-Q	440 VALVE SUB/ASB QC	336.51	56610-10-467BE	460 MANIFOLD	4414.54
56607-2-Q-SS	440 VALVE SUB/ASB QC SS	459.06	56610-10-467BEC	460 BALL VALVES	4414.54
56608-2-451BEC	450 MANIFOLD	487.07	56610-10-469BEC	460 BALL VALVE	5595.83
56608-2-452BEC	450 MANIFOLD	991.02	56610-11-1Q-D	461BEC FOR AIRJET	582.77
56608-2-453BEC	450 MANIFOLD	1494.97	56610-11-1Q-DN	461BEC NEG AIRJET	582.77
56608-2-454BEC	450 MANIFOLD	1998.97	56610-11-3Q-D	463BEC FOR AIRJET	1798.49
56608-2-455BEC	450 MANIFOLD	2502.91	56610-11-4Q-D	464BEC FOR AIRJET	2406.24
56608-24-453BEC	450 MANIFOLD	2292.91	56610-11-54-C60TU	465BEC FOR AIRJET	3280.53
56608-3-451BEC	450 MANIFOLD	525.61	56610-11-6Q-D	466BEC FOR AIRJET	3622.06
56608-3-452BEC	450 MANIFOLD	1015.20	56610-11-6Q-DN	466BEC NEG AIRJET	3622.06
56608-3-453BEC	450 MANIFOLD	1504.77	56610-11-7Q-D	467BEC FOR AIRJET	4229.89
56608-3-454BEC	450 MANIFOLD	1994.41	56610-11-7Q-DN	467BEC NEG AIRJET	4229.89
56608-3-455BEC	450 MANIFOLD	2484.02	56610-11-9Q-D	469BEC FOR AIRJET	5445.27
56608-36-453BEC-3FBQ-D	450 FB MANIFOLD	3647.18	56610-11-9Q-DN	469BEC NEG AIRJET	5445.27
56608-41-453BEC-2F-COC	450 MANIFOLD SPECIAL W/ STRAINERS	1852.01	56610-12-464BEC-3FB	460 MANIFOLD	4199.73
56608-41-455BEC-2F-COC	450 MANIFOLD SPECIAL W/ STRAINERS	2996.04	56610-13-460BR	460BR REG VALVE	647.24
56608-43-455BE	450 MANIFOLD 2WY	6293.97	56610-15-462BEC	460 MANIFOLD BSPT	1261.29
56608-44	TEEJET KIT 203 SPECIAL	1735.26	56610-16-462BEC	460 MANIFOLD BSPT	1261.29
56608-45	440 SPECIAL KIT	1690.07	56610-18-460BR	460 REGULATING VALVE	647.24
56608-46	440SS SPECIAL KIT	332.91	56610-21-462BEC	460 MANIFOLD	2662.86
56608-47	ENVISIO SPECIAL KIT	423.26	56610-21-464BEC	460 MANIFOLD	3884.70
56608-48	450BEC W/80 STRAINER KIT	331.03	56610-22-4610BEC	460 MANIFOLD	8393.22
56608-49	450BEC W/50 STRAINER KIT	334.43	56610-22-4611BEC	460 MANIFOLD	9222.00
56608-56-453BEC-3FB	450BEC MANIFOLD	1962.66			
56608-56-455BEC-3FB	450FB MANIFOLD	3095.64			
56608-57-451BEC-2F	450BEC MANIFOLD SPEC	1717.73			

PART NO.	DESCRIPTION	U.S.DOLLARS	PART NO.	DESCRIPTION	U.S.DOLLARS
56610-22-4612BEC	460 MANIFOLD	10050.79	56720-1/8-F	AIR CHEMSAVER	55.10
56610-22-4618BEC	460 MANIFOLD	15023.49	56885	BRL MOTOR F/CARUELLE	535.34
56610-22-465BEC	460 MANIFOLD	4249.31	5700	MULTEEJET TIP ASB,BR	55.48
56610-22-466BEC	460 MANIFOLD	5078.12	5780-AX120	ADJ.CONEJET TIP,BR.	44.98
56610-22-467BEC	460 MANIFOLD	5906.88	5780-AX20	ADJ.CONEJET TIP,BR.	44.98
56610-22-468BEC	460 MANIFOLD	6735.67	5780-AX30	ADJ.CONEJET TIP,BR.	44.98
56610-22-469BEC	460 MANIFOLD	7564.47	5780-AX45	ADJ.CONEJET TIP,BR.	44.98
56610-23-461BE-2	460 BE MANIFOLD	636.31	5780-AX60	ADJ.CONEJET TIP,BR.	44.98
56610-24-463BEC-2	460BEC MANIFOLD	2546.84	5780-AX90	ADJ.CONEJET TIP,BR.	44.98
56610-25	460 SUBASSY W/ FITTINGS	422.39	5780-AY-HSS120	ADJ.CONEJT TIP,BRHSS	47.65
56610-26-460BEC	460 BALL VALVE	565.63	5780-AY-HSS180	ADJ.CONEJT TIP,BRHSS	47.65
56610-6-461BEC	460 MANIFOLD	658.15	5780-AY-HSS20	ADJ.CONEJT TIP,BRHSS	47.65
56610-6-462BEC	460 MANIFOLD	1283.53	5780-AY-HSS30	ADJ.CONEJT TIP,BRHSS	47.65
56610-6-463BEC	460 MANIFOLD	1908.94	5780-AY-HSS45	ADJ.CONEJT TIP,BRHSS	47.65
56610-6-464BEC	460 MANIFOLD	2534.31	5780-AY-HSS60	ADJ.CONEJT TIP,BRHSS	47.65
56610-6-465BE	460 MANIFOLD	3159.69	5780-AY-HSS90	ADJ.CONEJT TIP,BRHSS	47.65
56610-6-465BEC	460 MANIFOLD	3159.69	5780-SS-AY-HSS60	ADJ.CONEJET TIP,SS	253.80
56610-6-467BEC	460 MANIFOLD	4334.65	58140-NYB	MANUAL CHEMSAVER	9.09
56610-9-B467BEC	460 BEC MANIFOLD	3750.66	58348H-1-CELR	QT CAP&WASHER BLACK	1.85
56611-2-1	460B VLV SUB ASB 1"	395.97	58348H-10-CELR	QT CAP&WASHER VIOLET	1.85
56611-2-3/4	460B VLV SUB/ASB 3/4	395.97	58348H-2-CELR	QT CAP&WASHER WHITE	1.85
56611-2-F	460B VLV SUB/ASB FLG	395.97	58348H-3-CELR	QT CAP&WASHER RED	1.85
56611-2-Q	460B VLV SUB/ASB QC	395.97	58348H-4-CELR	QT CAP&WASHER BLUE	1.85
56611-3C-1	460 3WAY C/VALVE SUB/ASB	644.04	58348H-5-CELR	QT CAP&WASHER GREEN	1.85
56611-3C-F	460 3WAY C/VALVE SUB/ASB	644.04	58348H-6-CELR	QT CAP&WASHER YELLOW	1.85
56611-3C-Q	460 3WAY C/VALVE SUB/ASB	644.04	58348H-7-CELR	QT CAP&WASHER BROWN	1.85
56611-3E-1	4603E1 VALVE SUB/ASB	445.36	58348H-8-CELR	QT CAP&WASHER ORANGE	1.85
56611-3FB-1	460 FLOWBACK	436.63	5838	HANDLE GRIP S/ASB	23.13
56611-3FB-F	4603FB VALVE SUB/ASB	445.36	5838-AL	HANDLE GRIP S/ASB AL	28.60
56611-3FB-Q	460 FLOWBACK	436.63	58430-1-430EC-2	2-WAY BALL VALVE ASB	305.14
56612-1-493BEC	490 MANIFOLD	2296.81	58430-1-431EC-2	2-WAY BALL VALVE MANI ASB	422.45
56612-2-491BEC	490 MANIFOLD	791.05	58430-1-432EC-2	2-WAY BALL VALVE MANI ASB	731.78
56612-2-492BEC	490 MANIFOLD	1546.11	58430-1-433EC-2	2-WAY BALL VALVE MANI ASB	1041.41
56612-2-493BEC	490 MANIFOLD	2301.13	58430-1-434EC-2	2-WAY BALL VALVE MANI ASB	1374.85
56612-2-494BEC	490 MANIFOLD	3056.18	58430-1-435EC-2	2-WAY BALL VALVE MANI ASB	1706.20
56612-2-495BEC	490 MANIFOLD	3811.23	58430-1-436EC-2	2-WAY BALL VALVE MANI ASB	2036.82
56612-3-491BEC-C	NORMAL OPEN 490BEC	686.43	58430-1-437EC-2	2-WAY BALL VALVE MANI ASB	2368.69
56612-3-492BEC-C	NORMAL OPEN 490BEC	1389.76	58430-1-438EC-2	2-WAY BALL VALVE MANI ASB	2699.95
56612-4-491BEC	490 MANIFOLD	778.06	58430-1-439EC-2	2-WAY BALL VALVE MANI ASB	3031.23
56612-4-493BEC	490 MANIFOLD	2268.32	58430-12-430EC-2	2-WAY BALL VALVE	321.65
56612-5-493BEC	490 MANIFOLD	2242.78	58430-18-430EC-2	2-WAY BALL VALVE ASB	327.16
56612-6-493BEC	490 MANIFOLD	2242.80	58430-18-432EC-2	2-WAY BALL VALVE ASB	1260.61
56612-8-491BEC-25CPC	490 MANIFOLD SPECIAL	708.35	58430-18-433EC-2	2-WAY BALL VALVE ASB	1586.74
56612-8-491BEC-25CQC	490 MANIFOLD SPECIAL	708.35	58430-2-433EC-2	2-WAY BALL VALVE MANI ASB	1129.66
56612-8-491BEC-25CRC	490 MANIFOLD SPECIAL	708.35	58430-2-435EC-2	2-WAY BALL VALVE MANI ASB	1879.04
56612-8-493BEC-25CPC	490 MANIFOLD SPECIAL	2158.91	58430-21-434E-2F75	2-WAY BALL VALVE ASB	2781.68
56612-8-493BEC-25CQC	490 MANIFOLD SPECIAL	2158.91	58430-21-435E-2F75	2-WAY BALL VALVE ASB	3007.11
56612-8-493BEC-25CRC	490 MANIFOLD SPECIAL	2158.91	58430-21-436E-2F75	2-WAY BALL VALVE ASB	3232.56
56680-3-364BE	56680-3-364BE BALL VALVE	475.41	58430-27-432EC-2	2-WAY BALL VALVE ASB	899.39
56681-1	RPL./ASB 364B 3 WAY LQC/QC L/ MTR	395.01	58430-27-433EC-2	2-WAY BALL VALVE ASB	1292.76
56681-2-LQ	RPL./ASB 364BLQ L/MTR	322.75	58430-29-P432-EC	2 WAY BALL VALVE ASB	794.33
56681-2-LQ-SS	RPL./ASB 364BLQ-SS L/MTR	445.31	58430-3-433E-2	2 WAY BALL VALVE MANI ASB	995.74
56682-3-366BEC	N.O. BALL VALVE SPECIAL	1257.55	58430-3-433EC-2	2 WAY BALL VALVE MANI ASB	995.74
56683-2-LQ	56683-2-LQ BV ASB.	623.96	58430-30-P432-EC	2 WAY BALL VALVE ASB	794.33
56683-3-LQ	RPL./ASB 366B 3 WAY LQ L/MTR	623.96	58430-32-432EC-2	2-WAY BALL VALVE MAN	943.37
56685-XRC110025-VP	XRC W/ 50854	13.26	58430-32-433EC-2	2-WAY BALL VALVE MAN	1336.71
56685-XRC11010-VP	XRC W/ 50854	13.26	58430-32-435EC-2	2-WAY BALL VALVE MAN	2106.05
56685-XRC11015-VP	XRC W/ 50854	13.26	58430-4-430EC-2	2-WAY BALL VALVE ASB	339.10
56685-XRC11020-VP	XRC W/ 50854	13.26	58430-4-431EC-2	2-WAY BALL VALVE MAN	451.84
56687-1	SJ3 KIT W/ 4193B	27.86	58430-4-432EC-2	2-WAY BALL VALVE MAN.	790.58
56687-2	SJ3 KIT W/ 4193B	105.89	58430-4-433EC-2	2-WAY BALL VALVE MAN	1129.59
56714-NYB	350A ENDCAP SUB/ASB	7.89	58430-4-434EC-2	2-WAY BALL VALVE MAN	1492.47
56720-1/8-B	AIR CHEMSAVER	55.10	58430-4-435EC-2	2-WAY BALL VALVE MAN	1853.14
			58430-4-436EC-2	2-WAY BALL VALVE MAN	2213.19

PART NO.	DESCRIPTION	U.S.DOLLARS	PART NO.	DESCRIPTION	U.S.DOLLARS
58430-4-437EC-2	2-WAY BALL VALVE MAN	2574.46	58456-90-1250	LQC X 90 X 1-1/4" HB KIT	25.02
58430-4-438EC-2	2-WAY BALL VALVE MAN	2935.10	58456-90-1500	LQC X 90 X 1-1/2" HB KIT	25.02
58430-4-439EC-2	2-WAY BALL VALVE MAN	3294.72	58456-90-2000	LQC X 90 X 2" HB KIT	25.02
58430-49-432EC-2F75	430EC 2WAY F75 MFLD SPECIAL	740.93	58456-C	LQC CAP KIT	25.02
58430-49-433EC-2F75	430EC 2WAY F75 MFLD SPECIAL	798.54	58456-P	LQC PLUG	25.02
58430-49-434EC-2F75	430EC 2WAY F75 MFLD SPECIAL	856.11	58470	430 2-WAY SUB ASSY	221.34
58430-49-435EC-2F75	430EC 2WAY F75 MFLD SPECIAL	913.72	58470-1	430 2-WAY SUB ASSY	275.26
58430-5-4310EC-2	430EC 2WAY W/M50 FLANGE	3006.48	58470-2	430 2-WAY SUB ASSY	499.93
58430-5-431EC-2	430EC 2WAY	344.54	58471	430 FB SUB-ASSY	248.69
58430-5-432EC-2	430EC 2WAY	625.76	58472	430 3WAY SUB ASSY	353.51
58430-5-433EC-2	430EC 2WAY	907.25	58480-0	MINI-DIN CONNECTOR ONLY	7.07
58430-5-434E-2	430E 2WAY W/M50 FLANGE	1212.69	58480E-05	2WR .5M MINI-DIN	23.13
58430-5-434EC-2	430EC 2WAY W/M50 FLANGE	1212.69	58480E-05-A	2WR .5M MINI-DIN	33.96
58430-5-435E-2	430E 2WAY W/M50 FLANGE	1515.88	58480E-05-CC	2WR .5M MINI-DIN	44.70
58430-5-435EC-2	430EC 2WAY W/M50 FLANGE	1515.88	58480E-05-EC	2WR .5M MINI-DIN	44.70
58430-5-436EC-2	430EC 2WAY W/M50 FLANGE	1819.03	58480E-05-FC	2WR .5M MINI-DIN	44.70
58430-5-437EC-2	430EC 2WAY W/M50 FLANGE	2122.20	58480E-05-GC	2WR .5M MINI-DIN	44.70
58430-5-438EC-2-D	430EC 2WAY W/M50 FLANGE	2425.35	58480E-05-HC	2WR .5M MINI-DIN	44.70
58430-5-439EC-2	430EC 2WAY W/M50 FLANGE	2728.51	58480E-05-OC	2WR .5M MINI-DIN	44.70
58430-6-431EC-2	2-WAY BALL VALVE ASB	439.02	58480E-05-VX	2WR .5M MINI-DIN	44.70
58430-6-432EC-2	2-WAY BALL VALVE ASB	760.66	58480E-15	2WR 1.5 MINI-DIN	28.20
58430-6-433EC-2	2-WAY BALL VALVE ASB	1082.28	58480E-15-A	2WR 1.5M MINI DIN	39.02
58430-6-434EC-2	2-WAY BALL VALVE ASB	1403.91	58480E-15-B	2WR 1.5M MINI-DIN	39.02
58430-6-435EC-2	2-WAY BALL VALVE ASB	1725.53	58480E-15-EC	2WR 1.5 MINI-DIN	51.26
58430-7-431E-2	431 BALL VALVE SPECIAL	414.07	58480E-15-ET	2WR 1.5M MINI-DIN	51.26
58430-8-433EC-2	2-WAY BALL VALVE MANI ASB	1129.66	58480E-15-FD	2WR 1.5M MINI-DIN	51.26
58430-8-435EC-2	2-WAY BALL VALVE MANI ASB	1879.04	58480E-15-IS	2WR 1.5M MINI-DIN	51.26
58430-9-430EC-2	2 WAY BALL VALVE MANI ASB	341.09	58480E-200	2WR 20M MINI _DIN	129.62
58430-9-4310EC-2	430 2-WAY SPECIAL	3724.38	58480E-200-IC	2WR 20M MINI-DIN	151.18
58430-9-4311EC-2	430 2-WAY SPECIAL	4091.61	58480E-30	2 WR 3.0M MINI-DIN	47.32
58430-9-4312EC-2	2-Way Ball Valve Mani Asb	4458.84	58480E-30-EC	2 WR 3.0M MINI-DIN	68.89
58430-9-4313EC-2	2-Way Ball Valve Mani Asb	4826.06	58480E-30-PB	2 WR 3.0M MINI-DIN	68.89
58430-9-4314EC-2	2-Way Ball Valve Mani Asb	5193.29	58480E-30-VX	2WR 3M MINI-DIN	68.89
58430-9-4315EC-2	2-Way Ball Valve Mani Asb	5560.52	58480E-60	2WR 6.0M MINI-DIN	61.38
58430-9-431EC-2	2 WAY BALL VALVE MANI ASB	460.65	58480E-80	2WR 8.0M MINI-DIN	70.80
58430-9-432EC-2	2 WAY BALL VALVE MANI ASB	805.96	58480E-80-A	2WR 8.0M MINI-DIN	81.62
58430-9-433EC-2	2 WAY BALL VALVE MANI ASB	1151.54	58480E-80-VX	2WR 8.0M MINI-DIN	92.79
58430-9-434EC-2	2 WAY BALL VALVE MANI ASB	1521.09	58480EC-05	3WR .5M MINI-DIN	23.13
58430-9-435EC-2	2 WAY BALL VALVE MANI ASB	1888.27	58480EC-05-J	3WR .5M MINI-DIN	33.96
58430-9-436EC-2	2 WAY BALL VALVE MANI ASB	2254.85	58480EC-05-K	3WR .5M MINI DIN	33.96
58430-9-437EC-2	2 WAY BALL VALVE MANI ASB	2622.72	58480EC-05-OB	3WR .5M MINI-DIN	44.70
58430-9-438EC-2	2 WAY BALL VALVE MANI ASB	2989.93	58480EC-05-OC	3WR .5M MINI-DIN	44.70
58430-9-439EC-2	2 WAY BALL VALVE MANI ASB	3357.17	58480EC-05-OG	3WR .5M MINI-DIN	44.70
58445	430 EC REPL MOTOR	245.14	58480EC-05-PB	3WR .5M MINI-DIN	44.70
58445-P	430EC REPL MOTOR METRI	223.73	58480EC-05-PC	3WR .5M MINI-DIN	44.70
58446	430 E REPL MOTOR	245.14	58480EC-05-PG	3WR .5M MINI-DIN	44.70
58446-P	430E REPL MOTOR METRI	223.73	58480EC-05-PK	2WR .5M MINI DIN	44.70
58447	430 EC NEG REPL MOTOR	245.14	58480EC-05-QB	3WR .5M MINI-DIN	44.70
58447-P	430EC NEG REPL MOTOR METRI	223.73	58480EC-05-QC	3WR .5M MINI-DIN	44.70
58449	430EC NORMALLY OPEN MOTOR	245.14	58480EC-05-RB	3WR .5M MINI-DIN	44.70
58449-P	430EC NORMALLY OPEN MOTOR METRI	223.73	58480EC-05-SS	3WR .5M MINI-DIN	44.70
58456-1	LQC X 1" NPT F KIT	25.02	58480EC-05-UX	3WR .5M MINI-DIN	44.70
58456-1-1/2	LQC X1 1/2 NPT F KIT	25.02	58480EC-05-VR	3WR .5M MINI-DIN	44.70
58456-1-1/4	LQC X1 1/4"NPT F KIT	25.02	58480EC-05-VX	3WR .5M MINI-DIN	44.70
58456-1/4	LQC GUAGE PT NPT KIT	25.02	58480EC-05-WR	3WR .5M MINI-DIN	44.70
58456-1000	LQC X 1" HB KIT	25.02	58480EC-15	3WR 1.5M MINI-DIN	28.20
58456-1250	LQC X 1 1/4 HB KIT	25.02	58480EC-15-J	3WR 1.5M MINI-DIN	39.02
58456-1250M	1 ¼ HB OUTLET X M LQC	25.02	58480EC-15-K	3WR 1.5M MINI-DIN	39.02
58456-1500	LQC X 1 1/2 HB KIT	25.02	58480EC-15-OB	3WR 1.5M MINI-DIN	51.26
58456-1500M	1 ½ HB OUTLET X M LQC	25.02	58480EC-15-OC	3WR 1.5M MINI-DIN	51.26
58456-2000	LQC X 2 HB KIT	25.02	58480EC-15-PB	3WR 1.5M MINI-DIN	51.26
58456-3/4	LQC X 3/4" NPT F KIT	25.02	58480EC-15-PC	3WR 1.5M MINI-DIN	51.26
58456-90-1000	LQC X 90 X 1" HB KIT	25.02	58480EC-15-TB	3WR 1.5M MINI-DIN	51.26
			58480EC-15-TC	3WR 1.5M MINI-DIN	51.26

PART NO.	DESCRIPTION	U.S.DOLLARS	PART NO.	DESCRIPTION	U.S.DOLLARS
58480EC-15-TS	3WR 1.5M MINI-DIN	51.26	58570-5-432EC-3FB	430EC-3FB W/ M50 FLANGE	661.76
58480EC-15-VX	3WR 1.5 MINI-DIN	51.26	58570-5-433EC-3FB	430EC-3FB W/ M50 FLANGE	989.96
58480EC-15-WC	3WR 1.5M MINI-DIN	51.26	58570-5-434EC-3FB	430EC-3FB MANIFOLD SPECIAL	1319.86
58480EC-200	3WR 20.0M MINI-DIN	129.62	58570-5-435EC-3FB	430EC-3FB W/ M50 FLANGE	1648.05
58480EC-30	3WR 3.0M MINI-DIN	47.32	58570-5-436EC-3FB	430EC-3FB W/ M50 FLANGE	1976.22
58480EC-30-J	3WR 3.0M MINI-DIN	58.16	58570-5-437EC-3FB	430EC-3FB W/ M50 FLANGE	2309.83
58480EC-30-OC	3WR 3.0M MINI-DIN	68.89	58570-5-438EC-3FB	430EC-3FB W/ M50 FLANGE	2639.49
58480EC-30-VX	3WR 3.0M MINI-DIN	68.89	58570-5-439EC-3FB	430EC-3FB W/ M50 FLANGE	3029.15
58480EC-60	CABLE ASSY, 3 POS DIN 6 METER, 58480EC-60	61.38	58570-7-433EC-3FB	430 FLOWBACK MANIFOLD	1238.11
58480EC-80	3WR 8.0M MINI-DIN	70.80	58570-7-435EC-3FB	430 FLOWBACK MANIFOLD	2013.10
58561	430 2 WAY BALL & STEM KIT	112.32	58570-8-437EC-3FBF75	FLOWBACK BALLVALVE MANI	4871.23
58562	430 3FB WAY BALL & STEM KIT	112.32	58570-8-439EC-3FBF75	430 FLOWBACK MANIFOLD	5730.17
58563	430 INLT ADAPTER KIT	34.28	58570-9-430E-3FBF75	430E-3FB MANIFOLD	328.26
58564-1	1 MANIFOLD ASB KIT	140.78	58570-9-430EC-3FBF75	430EC-3FB MANIFOLD	328.26
58564-10	10 MANIFOLD ASB KIT	136.67	58570-9-4310E-3FBF75	430E-3FB MANIFOLD	3299.55
58564-11	11 MANIFOLD ASB KIT	136.67	58570-9-4310EC-3FBF75	430EC-3FB MANIFOLD	3299.55
58564-12	12 MANIFOLD ASB KIT	136.67	58570-9-431E-3FBF75	430E-3FB MANIFOLD	372.11
58564-13	13 MANIFOLD ASB KIT	136.67	58570-9-431EC-3FBF75	430EC FB MANIFOLD	372.11
58564-14	14 MANIFOLD ASB KIT	136.67	58570-9-432E-3FBF75	430E-3FB MANIFOLD	680.86
58564-15	15 MANIFOLD ASB KIT	136.67	58570-9-432EC-3FBF75	430EC FB MANIFOLD	680.86
58564-2	2 MANIFOLD ASB KIT	140.78	58570-9-433E-3FBF75	430E-3FB MANIFOLD	989.96
58564-3	3 MANIFOLD ASB KIT	140.78	58570-9-433EC-3FBF75	430EC-3FB MANIFOLD	989.96
58564-4	4 MANIFOLD ASB KIT	140.78	58570-9-434E-3FBF75	430E-3FB MANIFOLD	1319.86
58564-5	5 MANIFOLD ASB KIT	140.78	58570-9-434EC-3FBF75	430EC-3FB MANIFOLD	1319.86
58564-6	6 MANIFOLD ASB KIT	140.78	58570-9-435E-3FBF75	430E-3FB MANIFOLD	1649.93
58564-7	7 MANIFOLD ASB KIT	136.67	58570-9-435EC-3FBF75	430EC-3FB MANIFOLD	1649.93
58564-8	8 MANIFOLD ASB KIT	136.67	58570-9-436E-3FBF75	430E-3FB MANIFOLD	1990.93
58564-9	9 MANIFOLD ASB KIT	136.67	58570-9-436EC-3FBF75	430EC-3FB MANIFOLD	1990.93
58566-1-NYB	QJS T END BODY	20.51	58570-9-437E-3FBF75	430E-3FB MANIFOLD	2309.83
58566-NYB	END BODY SUB-ASSY	20.51	58570-9-437EC-3FBF75	430EC-3FB MANIFOLD	2309.83
58570-1-430EC-3FB	430 FB SPECIAL	304.89	58570-9-438E-3FBF75	430E-3FB MANIFOLD	2639.49
58570-1-431EC-3FB	430 FB SPECIAL	441.80	58570-9-438EC-3FBF75	430EC-3FB MANIFOLD	2639.49
58570-1-433EC-3FB	430 FB SPECIAL	1182.25	58570-9-439E-3FBF75	430E-3FB MANIFOLD	3029.15
58570-1-435EC-3FB	430 FB SPECIAL	1920.99	58570-9-439EC-3FBF75	430EC-3FB MANIFOLD	3029.15
58570-1-437EC-3FB	430 FB SPECIAL	2659.71	58573-1-NYB	QJS T MIDDLE BODY	21.12
58570-1-439EC-3FB	430 FB SPECIAL	3398.40	58573-NYB	MIDDLE BODY SUB-ASSY	21.12
58570-13-435EC-3FBF75	430 3FB MNFD SPECIAL	4051.84	58574-1-6	QJS 1" BOTTOM MOUNT 6MM	34.41
58570-13-437EC-3FBF75	430 3FB MNFD SPECIAL	4796.93	58574-1-NYB	QJS 1" BOTTOM MOUNT	34.41
58570-13-439EC-3FBF75	430 3FB MNFD SPECIAL	5542.02	58574-1/2-6	QJS 1/2" BOTTOM MOUNT 6MM	34.41
58570-2-430EC-3FB	FLOWBACK BALLVALVE ASB	356.36	58574-1/2-NYB	QJS 1/2" BOTTOM MOUNT	34.41
58570-2-431EC-3FB	FLOWBACK BALLVALVE MANI	475.76	58574-20MM-6	QJS 20MM BOTTOM MOUNT 6MM	34.41
58570-2-432EC-3FB	FLOWBACK BALLVALVE MANI	812.66	58574-20MM-NYB	20MM BOTTOM MOUNT	34.41
58570-2-433EC-3FB	FLOWBACK BALLVALVE MANI	1149.83	58574-25MM-6	QJS 25MM BOTTOM MOUNT 6MM	34.41
58570-2-434EC-3FB	FLOWBACK BALLVALVE MANI	1507.83	58574-25MM-NYB	QJS 25MM BOTTOM MOUNT	34.41
58570-2-435EC-3FB	FLOWBACK BALLVALVE MANI	1865.98	58574-28MM-NYB	QJS 28MM Bottom Mount	34.40
58570-2-436EC-3FB	FLOWBACK BALLVALVE MANI	2235.13	58574-3/4-6	QJS 3/4" BOTTOM MOUNT 6MM	34.41
58570-2-437EC-3FB	FLOWBACK BALLVALVE MANI	2582.13	58574-3/4-NYB	QJS 3/4" BOTTOM MOUNT	34.41
58570-2-438EC-3FB	FLOWBACK BALLVALVE MANI	2939.88	58574-R-1-6	QJS 1" BOTTOM MOUNT 6MM W/ RIGHT HAND CV	34.41
58570-2-439EC-3FB	FLOWBACK BALLVALVE MANI	3357.62	58574-R-1-NYB	QJS 1" BOTTOM MOUNT W/ RIGHT HAND CV	34.41
58570-20-437EC-3FB	430 FB MNFD SPECIAL	2482.14	58576-1-6	QJS 1" SIDE MOUNT 6MM	11.54
58570-23-437EC-3FB	430 FB MNFD SPECIAL	2487.42	58576-1-NYB	QJS 1" SIDE MOUNT	11.54
58570-3-430EC-2	430 2WY RPL HAGIE STX10	334.55	58576-1/2-6	QJS 1/2" SIDE MOUNT 6MM	11.54
58570-3-430EC-3FB	430 FLOWBACK SPECIAL	385.78	58576-1/2-NYB	QJS 1/2" SIDE MOUNT	11.54
58570-4-430EC-3FB	430 FLOWBACK SPECIAL	377.47	58576-20MM-6	QJS 20MM SIDE MOUNT 6MM	11.54
58570-4-431EC-3FB	430 FLOWBACK SPECIAL	421.27	58576-20MM-NYB	QJS 20MM SIDE MOUNT	11.54
58570-4-432EC-3FB	430 FLOWBACK SPECIAL	779.24	58576-25MM-6	QJS 25MM SIDE MOUNT 6MM	11.54
58570-4-433EC-3FB	430 FLOWBACK SPECIAL	1137.50	58576-25MM-NYB	QJS 25MM SIDE MOUNT	11.54
58570-4-434EC-3FB	430 FLOWBACK SPECIAL	1516.61	58576-28MM-6	QJS 28MM side Mount	11.53
58570-4-435EC-3FB	430 FLOWBACK SPECIAL	1895.87	58576-3/4-6	QJS 3/4" SIDE MOUNT 6MM	11.54
58570-4-436EC-3FB	430 FLOWBACK SPECIAL	2286.08	58576-3/4-NYB	QJS 3/4" SIDE MOUNT	11.54
58570-4-437EC-3FB	430 FLOWBACK SPECIAL	2654.19			
58570-4-438EC-3FB	430 FLOWBACK SPECIAL	3033.02			
58570-4-439EC-3FB	430 FLOWBACK SPECIAL	3471.84			

PART NO.	DESCRIPTION	U.S.DOLLARS	PART NO.	DESCRIPTION	U.S.DOLLARS
58577	END CAP SUB-ASSEMBLY	9.85	6290-2	JET AGITATOR,BRASS	66.29
58580-1-432EC-3	432EC-3WAY W/ M50 FLANGE	802.39	6290-2-AL	JET AGITATOR,ALUM.	58.12
58580-1-433EC-3	433EC-3WAY W/ M50 FLANGE	1170.52	6290-2-SS	JET AGITATOR,ST.STL.	168.21
58580-1-434EC-3	434EC-3WAY W/ M50 FLANGE	1566.19	6290-3	JET AGITATOR,BRASS	66.29
58580-1-435EC-3	435EC-3WAY W/ M50 FLANGE	1976.22	6290-3-AL	JET AGITATOR,ALUM.	58.12
58580-1-436EC-3	430 3-WAY SPECIAL	2357.75	6290-3-SS	JET AGITATOR,ST.STL.	168.21
58580-1-437EC-3	437EC-3WAY W/ M50 FLANGE	2739.29	6290-5	JET AGITATOR,BRASS	66.29
58580-1-439EC-3	439EC-3WAY W/M50 FLANGE	3531.48	6290-5-SS	JET AGITATOR,ST.STL.	168.21
58580-2-433EC-3	430 3WAY MANIFOLD	1284.76	6290-8	JET AGITATOR,BRASS	66.29
58580-2-435EC-3	430 3WAY MANIFOLD	1655.83	6290-8-SS	JET AGITATOR ST.STL.	168.21
58580-2-437EC-3	430 3WAY MANIFOLD	2262.14	6290SC-1	JET AGITATOR,BRASS	60.35
58580-2-439EC-3	430 3 WAY MANIFOLD	3693.86	6290SC-1-AL	JET AGITATOR,ALUM.	58.12
58580-3-432EC-3	430 3 WAY MANIFOLD	897.58	6290SC-1-SS	JET AGITATOR,ST.STL.	240.20
58580-3-434EC-3	430 3 WAY MANIFOLD	1693.06	6290SC-10	JET AGITATOR,BRASS	60.35
58580-3-436EC-3	430 3 WAY MANIFOLD	2500.38	6290SC-10-AL	JET AGITATOR,ALUM.	58.12
58580-3-439EC-3	58580-3-439EC-3	3693.14	6290SC-10-SS	JET AGITATOR,ST.STL.	240.20
58580-4-433E-3	430 3WAY MANIFOLD	1285.00	6290SC-2	JET AGITATOR,BRASS	60.35
58580-4-434E-3	430 3WAY MANIFOLD	1693.56	6290SC-2-AL	JET AGITATOR,ALUM.	58.12
58585-N2-1/2-AA	QJS SPECIAL ASSEMBLY	154.05	6290SC-2-SS	JET AGITATOR,ST.STL.	240.20
58585-N2-3/4-EE	QJS SPECIAL ASSEMBLY	595.02	6290SC-3	JET AGITATOR,BRASS	60.35
5880-3/4-2TOC06	BOOMJET NOZ,BRASS	387.56	6290SC-3-AL	JET AGITATOR,ALUM.	58.12
5880-3/4-2TOC08	BOOMJET NOZ,BRASS	387.56	6290SC-3-SS	JET AGITATOR,ST.STL.	240.20
5880-3/4-2TOC10	BOOMJET NOZ,BRASS	387.56	6290SC-5	JET AGITATOR,BRASS	60.35
5880-3/4-2TOC20	BOOMJET NOZ,BRASS	387.56	6290SC-5-AL	JET AGITATOR,ALUM.	58.12
5880-3/4-2TOC40	BOOMJET NOZ,BRASS	387.56	6290SC-5-SS	JET AGITATOR,ST.STL.	240.20
5880-3/4-2TOC80	BOOMJET NOZ,BRASS	387.56	6290SC-8	JET AGITATOR,BRASS	60.35
5927	SHUT-OFF ASB,BRASS	34.61	6290SC-8-AL	JET AGITATOR,ALUM.	58.12
5927-1	SHUTOFF SUB-ASB,5927	23.92	6290SC-8-SS	JET AGITATOR,ST.STL.	240.20
5932-2-1/4T	TEEJET SW.BDY ASB,BR	51.83	63062-NYB	3WAY ADJUSTMENT DISC	85.02
6051-SS-100	TEEJET STRAINER,SS	16.82	6406	TEEJET ADPTER,BR,1/8	7.13
6051-SS-110	TEEJET STRAINER,SS	16.82	6406-1-SS	TEEJET ADPTR,SS,1/8	20.38
6051-SS-200	TEEJET STRAINER,SS	16.82	6406-AL	TEEJET ADPTER,AL,1/8	6.47
6051-SS-24	TEEJET STRAINER,SS	16.82	6406-I	TEEJET ADPTR,TEL STL,1/8	10.06
6051-SS-50	TEEJET STRAINER,SS	16.82	6466	TRIGGER TEEJET VALVE	76.51
6051-SS-80	TEEJET STRAINER,SS	16.82	6466-VI	TRIG.TEEJET VLV.W/VI	76.41
6053-400	HOSE SHANK CONN,BR.	6.50	6467-1	TRIGGER ASB,STL-PLTD	13.51
6053-535	HOSE SHANK CONN,BR.	6.50	6471-SS-C400TD	TEEJET HOSE CONN.ASB	169.04
6100-500	HOSE SHANK CONN,BR.	12.77	6471B-400TD	TEEJET HOSE CONN.ASB.	18.90
6100-675	HOSE SHANK CONN,BR.	12.77	6472-SS-C400TD	TEEJET HOSE CONN.ASB	163.35
6100-800	HOSE SHANK CONN,BR.	12.77	6472B-400TD	TEEJET HOSE CONN.ASB.	18.90
6104	TRIGGER VALVE,BRASS	70.33	6590	TRIGGER VALVE,NO-LOC	71.41
6104-NP	TRIGGER VALVE,BR-PLT	91.62	6590-VI	TRIG.TEEJT.VLV.W/VI	79.79
6104-VI	TRIG.TEEJT.VLV.W/VI	84.88	6671-18	18" CURV.EXT,BRASS	25.43
6115-AL	TRIPLE SPRAY HEADER	63.95	6671-24	24" CURV.EXT.,BR.	26.29
6135A-1/4	DIAPH.CHECK VALVE BRASS (#8 SPRING)	64.12	6671-30	30" CURV.EXT.BR.	29.71
6135A-1/4-AL	DIAPH.CHECK VALVE AL (#8 SPRING)	64.18	6671-36	36" CURV.EXT.BR.	33.80
6135A-3/8	DIAPH.CHECK VALVE BRASS (#8 SPRING)	64.12	6671-48	48" CURV.EXT.BR.	39.08
6135A-3/8-AL	DIAPH.CHECK VALVE AL (#8 SPRING)	57.54	6671-8	8" CURV.EXT.,BR.	20.87
6140A-1/4	DIAPH.CHECK VALVE BRASS (#8 SPRING)	76.23	6733-OC06	TEEJET TIP, BRASS	66.51
6140A-1/4-AL	DIAPH.CHECK VALVE AL (#8 SPRING)	68.43	6733-OC08	TEEJET TIP, BRASS	66.51
6140A-3/8	DIAPH.CHECK VALVE BRASS (#8 SPRING)	76.23	6733-OC10	OC-10 TEEJET TIP, BRASS	66.51
6140A-3/8-AL	DIAPH.CHECK VALVE AL (#8 SPRING)	68.43	6733-OC12	TEEJET TIP, BRASS	66.51
6240-1/4TT	TEEJET SW.BDY ASB,BR	28.77	6733-OC16	TEEJET TIP, BRASS	66.51
6290-1	JET AGITATOR,BRASS	66.29	6815-1/2-300	PRES.RELIEF VALVE,BR	110.53
6290-1-SS	JET AGITATOR,ST.STL.	168.21	6815-1/2-300-VI	PRES.RELIEF VALVE,BR W/VI GASKET	121.56
6290-10	JET AGITATOR,BRASS	66.29	6815-1/2-50	PRES.RELIEF VALVE,BR	110.53
6290-10-SS	JET AGITATOR,ST.STL.	168.21	6815-1/2-50-VI	PRES.RELIEF VALVE,BR W/VI GASKET	121.56
			6815-1/2-700	PRES.RELIEF VALVE,BR	110.53
			6815-1/2-HSS-1200	PRES.RELIEF VALVE BR	227.79
			6815-1/2-HSS-300	PRES.RELIEF VALVE,BR	156.15
			6815-1/2-HSS-700	PRES.RELIEF VALVE,BR	156.15
			6815-3/4-300	PRES.RELIEF VALVE,BR	110.53



PART NO.	DESCRIPTION	U.S.DOLLARS	PART NO.	DESCRIPTION	U.S.DOLLARS
6815-3/4-50	PRES.RELIEF VALVE BR	110.53	7620B-T-AL	TEEJET SW.BDY ASB,AL	17.32
6815-3/4-700	PRES.RELIEF VALVE,BR	110.53	7630-100	TEEJET DISC STRAINER SS	2.89
6815-3/4-AL-300	PRES.RELIEF VALVE,AL	92.06	7630-200	TEEJET DISC STRAINER	2.89
6815-3/4-AL-50	PRES.RELIEF VALVE,AL	92.06	7630-325	TEEJET DISC STRAINER	2.89
6815-3/4-HSS-1200	PRES.RELIEF VALVE,BR	227.79	7630-50	TEEJET DISC STRAINER	2.89
6815-3/4-HSS-300	PRES.RELIEF VALVE,BR	156.15	7715-12	12" EXT,BR.	20.80
6815-3/4-HSS-700	PRES.RELIEF VALVE,BR	156.15	7715-18	18" BRASS EXTENSION	22.50
6815G-1/2-300	PRES.RELIEF VALVE,BR	203.21	7715-24	24" EXTENSION,BR.	24.30
6815G-1/2-700	PRES.RELIEF VALVE,BR	203.21	7715-3	3" EXTENSION, BRASS	22.50
6815G-3/4-300	PRES.RELIEF VALVE BR	203.21	7715-30	30" EXTNSION,BR,	29.11
6815G-3/4-700	PRES.RELIEF VALVE,BR	203.21	7715-36	36" EXT,BR.	30.74
7029	G.HOSE THD.ADAPT.BR.	19.21	7715-48	48" EXTNSION,BR,	37.23
7227-3/4X1/4-AL	BUSHING,ALUM,3/4X1/4	13.30	7715-8	8" BRASS EXTENSION	17.86
7227-3/4X3/8-AL	BUSHING,ALUM,3/4X3/8	13.30	7771-3/4X1/2	BUSHNG,BRASS,3/4X1/2	10.02
7421-1/2CT	TEEJET SPLT-EYLT ASB	11.34	801	801 FLOW METER F50	983.76
7421-1/2CT-SS	TEEJET SPLT-EYLT ASB	19.97	801A	801A FLOW METER 430 MNFD	983.76
7421-1/2T	TEEJET SPLT-EYLT ASB	10.70	802	802 FLOW METER F75	1053.15
7421-1/2T-NYB	TEEJET SPLT-EYLT ASB	5.86	8079-PP-100	100 MESH TRAFFIC GREEN TEEJET STR.POLYPRO.	1.82
7421-1/2T-SS	TEEJET SPLT-EYLT ASB	18.92	8079-PP-200	TEEJET STR.POLYPRO. PINK	1.82
7421-1/2TD-SS	TEEJET SPLT-EYLT ASB	27.35	8079-PP-24	TEEJET STR.POLYPRO. WHITE	1.82
7421-1CT	TEEJET SPLT-EYLT ASB	11.34	8079-PP-50	TEEJET STR.POLYPRO. BLUE	1.82
7421-1CT-SS	TEEJET SPLT-EYLT ASB	18.92	8079-PP-80	TEEJET STR.POLYPRO. YELLOW	1.82
7421-1T	TEEJET SPLT-EYLT ASB	10.70	8120-NYB-406TD	TEEJET HOSE CONN.ASB	4.72
7421-1T-NYB	TEEJET SPLT-EYLT ASB	5.86	8120-NYB-540TD	TEEJET HOSE CONN.ASB	4.72
7421-1T-SS	TEEJET SPLT-EYLT ASB	18.92	8121-NYB-406TD	TEEJET HOSE CONN.ASB	4.72
7421-3/4CT	TEEJET SPLT-EYLT ASB	11.34	8121-NYB-540TD	TEEJET HOSE CONN.ASB	4.72
7421-3/4CT-SS	TEEJET SPLT-EYLT ASB	18.92	8124-NYB-406TD	TJ BODY, 3/8", NYLON	4.72
7421-3/4T	TEEJET SPLT-EYLT.ASB	10.70	8124-NYB-540TD	TJ BODY, 1/2", NYLON	4.72
7421-3/4T-NYB	TEEJET SPLT-EYLT ASB	5.86	8355-1/4-NYB	DIAPH.TEEJET ASB,NYL	15.53
7421-3/4T-SS	TEEJET SPLT-EYLT ASB	18.92	8355-1/4-NYB-VI	DIAPH. TEEJET ASB, VITON	17.04
7421-3/4TD	TEEJET SPLT-EYLT ASB	14.80	8355-1/8-NYB	DIAPH.TEEJET ASB,NYL	15.53
7421-3/4TD-SS	TEEJET SPLT-EYLT ASB	27.35	8355-1/8-NYB-VI	DIAPH. TEEJET ASB, VITON	17.04
7421SS-1/2T-SS	TEEJET SPLT-EYLT ASB	31.53	8360-20-NYB	DIA CHECK VLV 20 PSI	24.68
7421SS-1T-SS	TEEJET SPLT-EYLT ASB	31.53	8360-MC	MANUAL DIAPHRAM	33.70
7421SS-3/4CT-SS	TEEJET SPLT-EYLT ASB	31.53	8360-NYB	DIAPH.TEEJET ASB,NYL	24.68
7421SS-3/4T-SS	TEEJET SPLT-EYLT ASB	31.53	8360-NYB-VI	DIAPH.TEEJET ASB,NYL,VI	26.17
7450-1/4X1/4	SWIVEL CONNECTOR, BR	18.22	8370A-1-1/2X1/2	SPLIT-EYELET CONN,BR	28.25
7450-2T	TEEJET SW.BDY.ASB,BR	48.44	8370A-1-1/2X1/4	SPLIT-EYELET CONN,BR	28.25
7521A-1/2X1/4	SPLIT-EYELET CONN,BR	12.82	8370A-1-1/2X3/8	SPLIT-EYELET CONN,BR	28.25
7521A-1/2X1/8	SPLIT-EYELET CONN,BR	12.82	8370A-1-1/4X1/2	SPLIT-EYELET CONN,BR	22.22
7521A-1X1/4	SPLIT-EYELET CONN,BR	12.82	8370A-1-1/4X1/4	SPLIT EYELET CONN,BR	22.22
7521A-1X1/8	SPLIT-EYELET CONN,BR	12.82	8370A-1-1/4X1/8	SPLIT EYELET CONN,BR	22.22
7521A-3/4X1/4	SPLIT-EYELET CONN,BR	12.82	8370A-1-1/4X3/8	SPLIT-EYELET CONN,BR	22.22
7521A-3/4X1/8	SPLIT-EYELET CONN,BR	12.82	8370A-2X1/2	SPLIT-EYELET CONN,BR	33.18
7521B-1/2X1/4	SPLT-EYLT.CON.ALL SS	32.11	8370A-2X1/4	SPLIT-EYELET CONN,BR	33.18
7521B-1/2X1/8	SPLT-EYLT.CON.ALL SS	32.11	8370A-2X3/8	SPLIT-EYELET CONN,BR	33.18
7521B-1X1/4	SPLT-EYLT.CON.ALL SS	32.11	8370B-1-1/2X1/2	SPLT-EYLT CON,ALL SS	62.27
7521B-1X1/8	SPLT-EYLT.CON.ALL SS	32.11	8370B-1-1/2X1/4	SPLT-EYLT CON,ALL SS	62.27
7521B-3/4X1/4	SPLT-EYLT.CON.ALL SS	32.11	8370B-1-1/2X1/8	SPLT-EYLT.CON.ALL SS	62.27
7521B-3/4X1/8	SPLT-EYLT.CON.ALL SS	32.11	8370B-1-1/2X3/8	SPLT-EYLT CON,ALL SS	62.27
7521C-1/2X1/4	SPLIT-EYELET CONN.SS	19.22	8370B-1-1/4X1/2	SPLT-EYLT CON,ALL SS	52.88
7521C-1/2X1/8	SPLT-EYLT.CON.SS	19.22	8370B-1-1/4X1/4	SPLT-EYLT CON,ALL SS	52.88
7521C-1X1/4	SPLIT-EYELET CONN.SS	19.22	8370B-1-1/4X3/8	SPLT-EYLT CON,ALL SS	52.88
7521C-1X1/8	SPLIT-EYELET CONN.SS	19.22	8370B-2X1/2	SPLT-EYLT CON,ALL SS	66.92
7521C-3/4X1/4	SPLIT-EYELET CONN.SS	19.22	8370B-2X1/4	SPLT-EYLT CON,ALL SS	66.92
7521C-3/4X1/8	SPLIT-EYELET CONN.SS	19.22	8370B-2X1/8	SPLT-EYLT.CON,ALL SS	66.92
7599-1/4-ENP	INLET ADP.BR-PLT, 22	6.50	8370B-2X3/8	SPLT-EYLT CON,ALL SS	66.92
7599-1/4-SS	INLET ADAPTER, SS	25.56	8370C-1-1/2X1/2	SPLIT-EYELET CONN,SS	48.33
7599-3/8-ENP	INLET ADAP.BR-PLT,22, ENP	6.50	8370C-1-1/2X1/4	SPLIT-EYELET CONN,SS	48.33
7599-3/8-SS	INLET ADAPTER, SS	25.56	8370C-1-1/2X3/8	SPLIT-EYELET CONN,SS	48.33
7618-1/8X1/8	SWIVEL CONNECT,BRASS	9.74	8370C-1-1/4X1/2	SPLIT-EYELET CONN,SS	41.67
7620-T	TEEJET SW.BDY ASB,BR	38.88	8370C-1-1/4X1/4	SPLIT-EYELET CONN,SS	41.67
7620B-1/8X1/4	SWIVEL CONNECTOR,BR.	12.78	8370C-1-1/4X3/8	SPLIT-EYELET CONN,SS	41.67
7620B-T	TEEJET SW.BDY ASB,BR	17.92			

PART NO.	DESCRIPTION	U.S.DOLLARS	PART NO.	DESCRIPTION	U.S.DOLLARS
8370C-2X1/2	SPLIT-EYELET CONN,SS	52.88	98450-10	SPEC DBLE ROLLOVER VALVE W/CHK	96.63
8370C-2X1/4	SPLIT-EYELET CONN,SS	52.88	98450-11	SPEC DBLE ROLLOVER VALVE W/CHK	96.63
8370C-2X3/8	SPLIT-EYELET CONN,SS	52.88	98450-12	SPEC DBLE ROLLOVER VALVE W/CHK	83.89
8400-1/2-406-NYB	HOSE SHANK CONN,NYL	3.26	98450-13	SPEC DBLE ROLLOVER VALVE W/CHK	96.63
8400-1/2-535-NYB	HOSE SHANK CONN,NYL	3.26	98450-2-1/4F	SPEC DBLE ROLLOVER VALVE W/CHK	66.18
8400-1/2-660-NYB	HOSE SHANK CONN,NYL	3.26	98450-2-1/4M	SPEC DOUBLE ROLLOVER VALVE W/CHK CP98455-1	66.18
8400-1/2-NYB	1/2 PIPE PLUG,NYLON	3.00	98450-2-3/8M	SPEC DBLE ROLLOVER VALVE W/CHK	66.18
8400-1/4-300-NYB	HOSE SHANK CONN,NYL	1.92	98450-3-1/4F	SPEC DBLE ROLLOVER VALVE W/CHK	65.78
8400-1/4-406-NYB	HOSE SHANK CONN,NYL	1.92	98450-3-1/4M	SPEC DBLE ROLLOVER VALVE W/CHK	65.78
8400-1/4-535-NYB	HOSE SHANK CONN.,NYB	1.92	98450-3-3/8M	SPEC DBLE ROLLOVER VALVE W/CHK	65.78
8400-1/4-PPB	1/4 PIPE PLUG, POLYPRO	2.26	98450-3/8M	DBLE ROLLOVER VALVE W/CHK	61.39
8400-3/4-535-NYB	HOSE SHANK CONN,NYL	3.50	98451-1/4F	SINGLE ROLLOVER VALVE W/CHK CP98455	56.98
8400-3/4-660-NYB	HOSE SHANK CONN,NYL	3.50	98451-1/4M	SINGLE ROLLOVER VALVE W/CHK CP98455-1	56.98
8400-3/4-785-NYB	HOSE SHANK CONN,NYL	3.50	98451-3/8M	SINGLE ROLLOVER VALVE W/CHK	56.98
8400-3/4-NYB	3/4 PIPE PLUG,NYLON	3.43	98452-1/4F	DOUBLE ROLLOVER VALVE	48.23
8400-3/8-406-NYB	HOSE SHANK CONN,NYL	2.50	98452-1/4M	DOUBLE ROLLOVER VALVE CP98461-1	48.23
8400-3/8-535-NYB	HOSE SHANK CONN.,NYL	2.50	98452-3/8M	3/8M-NPT, INLET BODY DOUBLE ROLLOVER NO/VALVE	48.23
8400-406-NYB	HOSE SHANK CONN. NYB	1.60	98453-1/4F	SINGLE ROLLOVER VALVE	43.84
8400-500-NYB	HOSE SHANK CONN,NYL.	1.60	98453-1/4M	SINGLE ROLLOVER VALVE W/CHK CP98461-1	43.84
8400-T-406-NYB	TEEJET HOSE SHANK,NY	3.50	98453-3/8M	SINGLE ROLLOVER VALVE	43.84
8460-1/2	PRES.REL.VALVE,NYLON	95.25	98465-15	END CAP, SUB-AS, 15 PSI	24.63
8460-1/2-50	PRES.REL.VALVE 50LB	95.25	98480	QJ380 CHECK VALVE SUB-ASSBLY	34.06
8460-3/4	PRES.REL.VALVE,NYLON	95.25	98489-1-NYB	QJS 1" TEE MOUNT	38.37
8460-3/4-50	PRES.REL.VALVE 50LB.	95.25	98489-1/2-NYB	QJS 1/2" TEE MOUNT	38.37
8600-1/4T-NYB	TEEJET SW.BDY.ASB,NY	12.76	98489-20MM-NYB	QJS 20MM SIDE MOUNT	38.37
8600-2-1/4T-NYB	TEEJET SW.BDY.ASB,NY	15.39	98489-25MM-NYB	QJS 25MM TEE MOUNT	38.37
8600-3-1/4T-NYB	TEEJET SW.BDY.ASB,NY	16.35	98489-3/4-NYB	QJS 3/4" TEE MOUNT	38.37
8604-50	STRAINER,BRASS	23.61	98504-1-344BRL	430 FM STR REG PR ASS'Y	690.53
8604-NP-50	STRAINER,BRASS,PLATD	23.61	98504-10-344BEC-BF	N.O. BYPASS SHUTOFF VALVE F50	493.16
9106	TEEJET FILTER,BRONZE	4.61	98504-11-344BEC-BQ	N.O. SHUTOFF VALVE	506.05
9191-SS-C531TD	TEEJET HOSE CONN.ASB	196.70	98504-12-344BEC	REG BY PR ASSY	1435.78
9191B-531TD	TEEJET HOSE CONN.ASB	18.90	98504-16-344BRL/344BEC	344BRL REG SPECIAL	2824.35
9192-SS-C531TD	TEEJET HOSE CONN.ASB	196.70	98504-2-344BRL-BQ-03C	430 FM REG BY, PR ASSY	1643.39
9192B-531TD	TEEJET HOSE CONN.ASB	18.90	98504-2-344BRL-BQ-03D	430 FM REG TH, PR ASS'Y	1643.39
9480-AL-1/2-HSS	PRES.RELIEF VALVE,AL	97.89	98504-2-344BRL-TH-03C	430 FM REG TH, PR ASS'Y	1624.05
9527-18	EXTENSION,BR.31-9525	65.04	98504-2-344BRL-TH-03D	430 FM REG TH, PR ASSY	1624.05
9527-24	EXTENSION,BR.31-9525	66.64	98504-22-344BRL	344BRL REG SPECIAL W/ 16D	1803.03
9527-36	EXTENSION,BR.31-9525	86.38	98504-23-344BRL/344BEC	344 REGULATION SPECIAL	2497.10
9527-48	EXTENSION,BR.31-9525	93.45	98504-3-344BRL-BQ-03C	430FM, RE TH, ASS'Y	1545.13
9527-8	EXTENSION,BR.31-9525	56.21	98504-3-344BRL-BQ-03CWB	430FM, RE TH, ASS'Y	1536.34
9751	BODY ASB,BR,5700 MUL	22.57	98504-3-344BRL-BQ-03D	430FM, REG BY, ASS'Y	1545.13
9758	END CAP ASB F/4664B & 4666B, BRASS (#8 LB. SPRING)	7.01	98504-3-344BRL-TH-03C	430FM, REG TH, ASS'Y	1525.82
9830-1TW-100	STRAINER,DUCT.IRON	448.57	98504-4	430 SHT BY, STR, REG BY, PR ASS'Y	881.13
9830-1TW-16	STRAINER,DUCT.IRON	448.57	98504-5-344BRL-BQ-03D	430 FM, STR, REG BY, PR ASSY	1798.37
9830-1TW-50	STRAINER,DUCT.IRON	448.57	98504-6	430 FB MNFD SPEC W/REG BY, STR, MSHT, MAN SHT, PR	1629.75
9830-3/4TW-100	STRAINER,DUCT.IRON	448.57	98504-7	430FM, STR, REG BY, PR, MSHT	2289.77
9830-3/4TW-16	STRAINER,DUCT.IRON	448.57	98504-8	430 FM ACCES. BYPASS W PR VALVE	1390.43
9830-3/4TW-50	STRAINER,DUCT.IRON	448.57	98504-9-344M	MANUAL MANIFOLD	2004.26
9840-1/2	PRES.RELIEF VALVE,BR	282.55	98505-BR-3/4	RPL/ASB 344BR-B3 L/MTR	322.75
9840-1/2-AL	PRES.RELIEF VALVE,AL	203.42			
9840-1/2-DI	PR.REL.VALVE,D.IRON	270.40			
9840-3/4	PRES.RELIEF VALVE,BR	282.55			
9840-3/4-AL	PRES.RELIEF VALVE,AL	203.42			
9840-3/4-DI	PR.REL.VALVE,D.IRON	270.40			
98450-1-1/4F	SPEC DBLE ROLLOVER VALVE W/CHK	65.37			
98450-1-1/4M	SPEC DBLE ROLLOVER VALVE W/CHK	65.37			
98450-1-3/8M	SPEC DBLE ROLLOVER VALVE W/CHK	65.37			
98450-1/4F	DOUBLE ROLLOVER VALVE W/CHK NPS CP98455	61.39			
98450-1/4M	DOUBLE ROLLOVER VALVE W/CHK CP98455-1	61.39			

PART NO.	DESCRIPTION	U.S.DOLLARS	PART NO.	DESCRIPTION	U.S.DOLLARS
98505-BR-Q	RPL/ASB 344BR-BQ L/MTR	322.75	98546EC-15-OC	shutoff metri-pac cable, 3wr,3pn,1.5m	51.26
98505-BR-TH	RPL/ASB 344BR-TH L/MTR	303.08	98546EC-15-RB	SHUTOFF METRI-PAC CABLE, 3WR,3PN, 1.5M	51.26
98505-BRL-3/4	RPL/ASB 344BRL-B3 L/MTR	310.25	98546EC-15-TU	SHUTOFF METRI-PAC CABLE, 3WR,3PN,1.5M	51.26
98505-BRL-F	RPL/ASB 344BRL-BF L/MTR	319.57	98546EC-15-VX	1.5 METER MP 150 CABLE EC-3WIRE (45-05840)	51.26
98505-BRL-Q	RPL/ASB 344BRL-BQ L/MTR	319.57	98546EC-30	SHUTOFF METRI-PAC CABLE, 3WR,3PN,3.0M	38.11
98505-BRL-TH	RPL/ASB 344BRL-TH L/MTR	303.08	98546EC-30-OC	SHUTOFF METRI-PAC CABLE, 3WR,3PN,3.0M	60.12
98510-NYB	98510 PRESSURE RELIEF VALVE 430 ACCESSORY	116.14	98546EC-30-VX	SHUTOFF METRI-PAC CABLE, 3WR,3PN,3.0M	60.12
98510-PP	PR VALVE, 430 ASSESSORY	116.14	98546EC-60	SHUTOFF METRI-PAC CABLE, 3WR,3PN,6.0M	46.92
98519-NYB	QJS TEE MOUNT	25.52	98546EC-60-OB	SHUTOFF METRI-PAC CABLE, 3WR,3PN,6.0M	68.90
98546EC-0	METRI-PAC CONNECTOR ONLY	15.23	98546EC-60-OC	SHUTOFF METRI-PAC CABLE, 3WR,3PN,6.0M	68.90
98546EC-03	SHUTOFF METRI-PAC CABLE, 3WR,3PN,0.3M	22.71	98546R-03	REGULATING METRI-PAC CABLE, 2WR,3PN,0.3M	22.71
98546EC-03-PG	SHUTOFF METRI-PAC CABLE, 3WR,3PN,0.3M	44.70	98546R-03-CC	REGULATING METRI-PAC CABLE, 2WR,3PN,0.3M	44.70
98546EC-05	SHUTOFF METRI-PAC CABLE, 3WR,3PN,0.5M	22.71	98546R-03-GS	REGULATING METRI-PAC CABLE, 2WR,3PN,0.3M	44.70
98546EC-05-CC	SHUTOFF METRI-PAC CABLE, 3WR,3PN,0.5M	44.70	98546R-05	REGULATING METRI-PAC CABLE, 2WR,3PN,0.5M	22.71
98546EC-05-CS	SHUTOFF METRI-PAC CABLE, 3WR,3PN,0.5M	44.70	98546R-05-CC	REGULATING METRI-PAC CABLE, 2WR,3PN,0.5M	44.70
98546EC-05-EC	3-WIRE METRI-PACK CABLE, 0.5M	44.70	98546R-05-CS	REGULATING METRI-PAC CABLE, 2WR,3PN,0.5M	44.70
98546EC-05-ES	3-WIRE METRI-PACK CABLE, 0.5M	44.70	98546R-05-EC	REGULATING METRI-PAC CABLE, 2WR,3PN,0.5M	44.70
98546EC-05-FC	3-WIRE METRI-PACK CABLE, 0.5M	44.70	98546R-05-ES	REGULATING METRI-PAC CABLE, 2WR,3PN,0.5M	44.70
98546EC-05-FS	3-WIRE METRI-PACK CABLE, 0.5M	44.70	98546R-05-FC	REGULATING METRI-PAC CABLE, 2WR,3PN,0.5M	44.70
98546EC-05-GS	3-WIRE METRI-PACK CABLE, 0.5M	44.70	98546R-05-GS	REGULATING METRI-PAC CABLE, 2WR,3PN,0.5M	44.70
98546EC-05-J	SHUTOFF METRI-PAC CABLE, 3WR,3PN,0.5M	44.70	98546R-05-HC	REGULATING DEUTSCH DT CABLE, 2WR, 2PN, 0.5M	44.70
98546EC-05-K	SHUTOFF METRI-PAC CABLE, 3WR,3PN,0.5M	44.70	98546R-05-HS	REGULATING DEUTSCH DT CABLE, 2WR, 2PN, 0.5M	44.70
98546EC-05-OB	SHUTOFF METRI-PAC CABLE, 3WR,3PN,0.5M	44.70	98546R-05-UG	REGULATING METRI-PAC CABLE, 2WR,3PN,0.5M	44.70
98546EC-05-OC	SHUTOFF METRI-PAC CABLE, 3WR,3PN,0.5M	44.70	98546R-05-UK	Regulating Metri-Pac 2WR 3PN	44.70
98546EC-05-OG	SHUTOFF METRI-PAC CABLE, 3WR,3PN,0.5M	44.70	98546R-15	REGULATING METRI-PAC CABLE, 2WR,3PN,1.5M	29.27
98546EC-05-OK	SHUTOFF METRI-PAC CABLE, 3WR,3PN,0.5M	44.70	98546R-30	REGULATING METRI-PAC CABLE, 2WR,3PN,3.0M	38.11
98546EC-05-PB	SHUTOFF METRI-PAC CABLE, 3WR,3PN,0.5M	44.70	98546R-60	REGULATING METRI-PAC CABLE, 2WR,3PN,6.0M	46.92
98546EC-05-PC	SHUTOFF METRI-PAC CABLE, 3WR,3PN,0.5M	44.70	98552-05	E-CHEMSAVER METRI-PAC CABLE, 2WR,2PN,0.5M	22.71
98546EC-05-PG	SHUTOFF METRI-PAC CABLE, 3WR,3PN,0.5M	44.70	98552-05-A	E-CHEMSAVER METRI-PAC CABLE, 2WR,2PN,0.5M	44.70
98546EC-05-PK	SHUTOFF METRI-PAC CABLE, 3WR,3PN,0.5M	44.70	98552-05-EC	E-CHEMSAVER METRI-PAC CABLE, 2WR,2PN,0.5M	44.70
98546EC-05-PU	SHUTOFF METRI-PAC CABLE, 3WR,3PN,0.5M	44.70	98552-05-FC	E-CHEMSAVER METRI-PAC CABLE, 2WR,2PN,0.5M	44.70
98546EC-05-QB	SHUTOFF METRI-PAC CABLE, 3WR,3PN,0.5M	44.70	98552-05-GC	E-CHEMSAVER METRI-PAC CABLE, 2WR,2PN,0.5M	44.70
98546EC-05-QC	SHUTOFF METRI-PAC CABLE, 3WR,3PN,0.5M	44.70	98552-05-HC	E-CHEMSAVER METRI-PAC CABLE, 2WR,2PN,0.5M	44.70
98546EC-05-SB	3-WIRE METRI-ACK CABLE, 0.5M	44.70	98552-05-HS	E-CHEMSAVER METRI-PAC CABLE, 2WR,2PN,0.5M	44.70
98546EC-05-UG	SHUTOFF METRI-PAC CABLE, 3WR,3PN,0.5M	44.70	98552-05-OC	E-CHEMSAVER METRI-PAC CABLE, 2WR,2PN,0.5M	44.70
98546EC-05-UK	SHUTOFF METRI-PAC CABLE, 3WR,3PN,0.5M	44.70			
98546EC-05-UX	SHUTOFF METRI-PAC CABLE, 3WR,3PN,0.5M	44.70			
98546EC-05-VR	3-WIRE METRI-PACK CABLE, 0.5M	44.70			
98546EC-05-VX	SHUTOFF METRI-PAC CABLE, 3WR,3PN,0.5M	44.70			
98546EC-05-WX	3-WIRE METRI-PACK CABLE, 0.5M	44.70			
98546EC-15	SHUTOFF METRI-PAC CABLE, 3WR,3PN,1.5M	29.27			
98546EC-15-OB	SHUTOFF METRI-PAC CABLE, 3WR,3PN, 1.5M	51.26			

PART NO.	DESCRIPTION	U.S.DOLLARS	PART NO.	DESCRIPTION	U.S.DOLLARS
98552-05-VX	E-CHEMSAVER METRI-PAC CABLE, 2WR,2PN,0.5M	44.70	98600-19-434EC-2	430 2WAY MNFD W/REG, STR, FM	3115.01
98552-15	E-CHEMSAVER METRI-PAC CABLE, 2WR,2PN,1.5M	29.27	98600-19-435EC-2	430 2WAY MNFD W/REG, STR, FM	3443.98
98552-15-VX	E-CHEMSAVER METRI-PAC CABLE, 2WR,2PN,1.5M	51.26	98600-2-432EC-2	430 MANIFOLD	1776.82
98552-2-05	E-CHEM OVERMOLDED AMP CABLE, 2WR,2PN,0.5M	35.03	98600-2-433EC-2	430 MANIFOLD	2071.20
98552-2-05-EC	E-CHEM OVERMOLDED AMP CABLE, 2WR,2PN,0.5M	57.03	98600-2-434EC-2	430 MANIFOLD	2389.48
98552-2-05-FC	E-CHEM OVERMOLDED AMP CABLE, 2WR,2PN,0.5M	57.03	98600-22-435EC-2	430 MANIFOLD	3787.66
98552-2-05-GC	E-CHEM OVERMOLDED AMP CABLE, 2WR,2PN,0.5M	57.03	98600-22-437EC-2	430 MANIFOLD	4158.58
98552-2-05-HC	E-CHEM OVERMOLDED AMP CABLE, 2WR,2PN,0.5M	57.03	98600-3-432EC-2	430 2WAY MNFD W/REG, STR	1531.56
98552-2-05-VX	E-CHEM OVERMOLDED AMP CABLE, 2WR,2PN,0.5M	57.03	98600-3-433EC-2	430 MANIFOLD	1825.95
98552-2-15	E-CHEM OVERMOLDED AMP CABLE, 2WR,2PN,1.5M	42.11	98600-3-434EC-2	430 MANIFOLD	2170.53
98552-2-15-VX	E-CHEM OVERMOLDED AMP CABLE,2WR,2PN,1.5M	64.10	98600-3-435EC-2	430 MANIFOLD	2460.32
98552-2-200	E-CHEM OVERMOLDED AMP CABLE, 2WR,2PN,20.0M	179.47	98600-4-432EC-2	430 2WAY MNFD W/REG, STR, FM	2515.24
98552-2-30	CABLE, 2-WIRE OVERMOLDED CTRL. w/AMPSS, 3.0 METER	50.75	98600-4-433EC-2	430 MANIFOLD	2809.63
98552-2-60	E-CHEM OVERMOLDED AMP CABLE, 2WR,2PN,6.0M	56.35	98600-4-434EC-2	430 MANIFOLD	3115.01
98552-2-60-FC	E-CHEM OVERMOLDED AMP CABLE, 2WR,2PN,6.0M	78.34	98600-4-435EC-2	430 MANIFOLD	3443.98
98552-200	E-CHEMSAVER METRI-PAC CABLE, 2WR,2PN,20.0M	163.95	98600-6-433EC-2	430 MANIFOLD	2073.39
98552-30	E-CHEMSAVER METRI-PAC CABLE, 2WR,2PN,3.0M	38.11	98600-6-435EC-2	430 MANIFOLD	2664.34
98552-60	E-CHEMSAVER METRI-PAC CABLE, 2WR,2PN,6.0M	46.92	98600-8-433E	430 MANIFOLD	2772.75
98579-1-NYR	QJ BLACK CAP&WASHER LARGE	2.95	98600-8-433EC	430 MANIFOLD	2772.75
98581-406-5-NYB	SPECIAL HOSE BARB ASSEMBLY	17.27	98600-9-435E-2	430 2-WAY MANIFOLD	4062.34
98600-1-433EC-2	430 2WAY MNFD W/FM, REG BY STR SHTOF NO BY PR	3358.36	98600-9-435EC-2	430 2-WAY MANIFOLD	4062.34
98600-1-434EC-2	430 2WAY MNFD W/FM, REG BY STR SHTOF NO BY PR	3676.62	98600-A-430EC-2	430 2WY RPLC	277.05
98600-1-435EC-2	430 2WAY MNFD W/FM, REG BY STR SHTOF NO BY PR	3941.20	98600-A-431EC-2	430 2WY MNFD W/PR	528.86
98600-1-437EC-2	430 2WAY MNFD W/FM, REG BY STR SHTOF NO BY PR	4094.04	98600-A-432EC-2	430 WY MNFD W/PR	810.11
98600-11-433EC-2	433 MANIFOLD BYPS	1896.59	98600-A-433EC-2	430 2WY MNFD W/PR	1091.63
98600-12-433EC-2	433 MANIFOLD TH	1667.08	98600-A-434EC-2	430 2WY MNFD W/PR	1397.03
98600-12-435EC-2	435 MANIFOLD TH	2410.23	98600-A-435EC-2	430 2WY MNFD W/PR	1700.25
98600-13-432EC-2	433 MANIFOLD PRV	1096.66	98600-A-436EC-2	430 2WY MNFD W/PR	2002.74
98600-13-433EC-2	430 MANIFOLD PRV	1490.02	98600-A-437EC-2	430 2WY MNFD W/PR	2306.55
98600-14-431E-2	430 MANIFOLD	1544.98	98600-A-438EC-2	430 2WY MNFD W/PR	2609.69
98600-14-431EC-2	430 MANIFOLD	1544.98	98600-A-439EC-2	430 2WY MNFD W/PR	2912.85
98600-16-432EC-2	430 2WY MNFD W/REG TH, STR	1503.97	98600-B-430EC-2	430 2WY RPLC	277.05
98600-16-433EC-2	430 2WY MNFD W/REG TH, STR	1705.54	98600-B-432EC-2	430 2WY MNFD W/STR, REG BY, PR	1370.37
98600-16-434EC-2	430 2WY MNFD W/REG TH, STR	2090.87	98600-B-433E-2	430E 2WY MNFD W/STR, REG BY, PR	1674.65
98600-16-435EC-2	430 2WY MNFD W/REG TH, STR	2394.07	98600-B-433EC-2	430 2WY MNFD W/STR, REG BY, PR	1674.65
98600-17-432EC-2	430 2WY MNFD W/801A, REG TH, STR	2365.65	98600-B-434EC-2	430 2WY MNFD W/FM,STR,REG BY,PR	1977.82
98600-17-433EC-2	430 2WY MNFD W/801A, REG TH, STR	2654.27	98600-B-435EC-2	430 2WY MNFD W/STR, REG BY, PR	2283.24
98600-17-434EC-2	430 2WY MNFD W/801A, REG TH, STR	2966.34	98600-B-437EC-2	430 2WY MNFD W/STR, REG BY, PR	2889.56
98600-17-435EC-2	430 2WY MNFD W/801A, REG TH, STR	3276.25	98600-B-439EC-2	430 2WY MNFD W/STR, REG BY, PR	3495.89
98600-19-432EC-2	430 2WAY MNFD W/REG, STR, FM	2515.24	98600-C-430EC-2	430 2WY RPLC	277.05
98600-19-433EC-2	430 2WAY MNFD W/REG, STR, FM	2809.63	98600-C-431EC-2	430 2WY MNFD W/FM, STR, REG BY, PR	1776.35
			98600-C-432EC-2	430 2WY MNFD W/FM, STR, REG BY, PR	1910.71
			98600-C-433EC-2	430 2WY MNFD W/FM, STR, REG BY, PR	2658.33
			98600-C-434EC-2	430 2WY MNFD W/FM, STR, REG BY, PR	2961.84
			98600-C-435EC-2	430 2WY MNFD W/FM, STR, REG BY, PR	3266.93
			98600-C-437EC-2	430 2WY MNFD W/FM, STR, REG BY, PR	3873.25
			98600-C-439EC-2	430 2WY MNFD W/FM, STR, REG BY, PR	4479.57
			98601-1-433EC-3FB	430 3FB MNFD W/FM, REG BY STR SHTOF NO BYPR	3492.28
			98601-1-434EC-3FB	430 3FB MNFD W/FM, REG BY STR SHTOF	3822.33

PART NO.	DESCRIPTION	U.S.DOLLARS	PART NO.	DESCRIPTION	U.S.DOLLARS
98601-1-435EC-3FB	430 3FB MNFD W/FM, REG BY STR SHTOF NO BY PR	4152.37	98601-B-434EC-3FB	430 3FB MNFD W/STR, REG BY, PR	2137.63
98601-1-437EC-3FB	430 3FB MNFD W/FM. REG BY STR SHTOF NO BY PR	4812.43	98601-B-435EC-3FB	430 3FB MNFD W/STR, REG BY, PR	2467.72
98601-1-438EC-3FB	430 3FB MNFD W/FM. REG BY STR SHTOF NO BY PR	5154.98	98601-C-430EC-3FB	430 3FB RPLC	328.26
98601-1-439EC-3FB	430 3FB MNFD W/FM. REG BY STR SHTOF NO BY PR	5500.11	98601-C-433EC-3FB	430 3FB MNFD W/FM, STR, REG B7Y, PR	2741.02
98601-10-433EC-3FB	430 MANIFOLD	2940.03	98601-C-434EC-3FB	430 3FB MNFD W/FM, STR, REG BY, PR	3070.92
98601-10-434EC-3FB	430 MANIFOLD	3295.68	98601-C-435EC-3FB	430 3FB MNFD W/FM, STR, REG B7Y, PR	3400.98
98601-10-435EC-3FB	430 MANIFOLD	3625.76	98601-C-437EC-3FB	430 3FB MNFD W/FM, STR, REG B7Y, PR	4060.90
98601-11-437EC-3FB	430 FB MNFD W/FM N.O. MOTOR	5176.79	98601-C-439EC-3FB	430 3FB MNFD W/FM, STR, REG B7Y, PR	4780.22
98601-12-435EC-3FB	430 3FM MNFD W/FM	2919.59	98602-1-434EC-3	430 3WY MNFD W/FM, REG BY, STR, SHTOF NO BY, PR	3991.51
98601-12-437EC-3FB	430 3FM MNFD W/FM	3529.86	98602-1-435EC-3	430 3WY MNFD W/FM, REG BY, STR, SHTOF NO BY, PR	4401.57
98601-13-435EC-3FB	430 3FB MNFD W/FM, REG BY STR SHTOF NO BY PR	4232.75	98602-10-435EC-3	430 3WY MNFD W/FM, REG BY, STR, 3 WAY SHTF	4905.75
98601-14-433EC-3FB	430 3FB MNFD W/FM, REG BY, SHTOF M BY, STR	3130.13	98602-10-437EC-3	430 3WY MNFD W/FM, REG BY, STR, 3 WAY SHTF	5698.54
98601-14-435EC-3FB	430 3FB MNFD W/FM, REG BY, SHTOF M BY, STR	3964.20	98602-11-433EC-3	430 3WY MNFD W/ REG BY, SHTOF NO BY, PR	2524.01
98601-16-433EC-3FB	430 3FB MNFD	1152.04	98602-12-435EC-3	430 3WY MNFD W/REG BY, SHTOF M BY, STR	3183.03
98601-16-437EC-3FB	430 3FB MNFD	2520.48	98602-13-432EC-3	430 3WY MNFD W/ PR	1273.27
98601-16-439EC-3FB	430 3FB MNFD	3272.34	98602-13-433EC-3	430 3WY MNFD W/ PR	1753.30
98601-18-432EC-3FB	430 FB MNFD	1035.99	98602-14-432EC-3	430 3WY MNFD	1145.25
98601-18-433EC-3FB	430 FB MNFD	1471.60	98602-14-433EC-3	430 3WY MNFD	1625.31
98601-2-433EC-3FB	98601-2-433EC-3FB	2158.32	98602-17-432EC-3	430 3WY MNFD	1022.03
98601-2-435EC-3FB	430 3FM MNFD W/FM	2844.07	98602-17-433EC-3	430 3WY MNFD	1388.31
98601-2-437EC-3FB	430 3FM MNFD W/FM	3529.86	98602-18-432EC-3	430 3WY MNFD W/REG TH, STR	1654.75
98601-20-432EC-3FB	430 3FB MNFD W/REG TH, STR	1532.77	98602-18-433EC-3	430 3WY MNFD W/REG TH, STR	1942.88
98601-20-433EC-3FB	430 3FB MNFD W/REG TH, STR	1762.32	98602-18-434EC-3	430 3WY MNFD W/REG TH, STR	2418.58
98601-20-434EC-3FB	430 3FB MNFD W/REG TH, STR	2172.23	98602-18-435EC-3	430 3WY MNFD W/REG TH, STR	2828.60
98601-20-435EC-3FB	430 3FB MNFD W/REG TH, STR	2828.56	98602-19-432EC-3	430 3WY MNFD	1065.16
98601-21-432EC-3FB	430 3FB MNFD W/801A, REG TH, STR	2439.22	98602-19-433EC-3	430 3WY MNFD	1453.04
98601-21-433EC-3FB	430 3FB MNFD W/801A, REG TH, STR	2760.64	98602-2-435E-3	430 3WY MNFD W/FM, REG BY, STR, SHTOF NO BY, PR	4401.57
98601-21-434EC-3FB	430 3FB MNFD W/801A, REG TH, STR	3096.75	98602-20-433EC-3FB	430 3WY MNFD W/ TH, FM	2692.20
98601-21-435EC-3FB	430 3FB MNFD W/801A, REG TH, STR	3463.49	98602-20-435EC-3FB	430 3WY MNFD W/ TH, FM	3737.58
98601-3-435E-3FB	430 3FB MNFD	2986.05	98602-20-437EC-3FB	430 3WY MNFD W/ TH, FM	4782.93
98601-4-435E-3FB	430 3FB MNFD	3058.96	98602-21-435EC-3	430 3-WAY MANIFOLD SPECIAL	2830.71
98601-5-437EC-3FB	430 FB MNFD W/REG BY, PR	3025.35	98602-28-433EC-3-D	433EC-3 REG, BY, PR SPECIAL	2119.07
98601-5-439EC-3FB	430 FB MNFD W/REG BY, PR	4738.50	98602-29-432EC-3-P	430 3WY MND W/REG TH,STR, 344M	1733.29
98601-6-437EC-3FB	430 FB MNFD W/REG BY, PR, SHTOF NO BY	3518.42	98602-29-433EC-3-P	430 3WY MND W/REG TH,STR, 344M	2000.01
98601-6-439EC-3FB	430 FB MNFD W/REG BY, PR, SHTOF NO BY	4237.73	98602-29-434EC-3-P	430 3WY MND W/ REG TH, STR, 344M	2454.29
98601-7-434EC-3FB	430 FB MNFD W/FM, STR, REG BY, MAN VLV, PR	3516.10	98602-29-435EC-3-P	430 3WY MND W/ REG TH, STR, 344M	2842.90
98601-8-437E-3FB	430 FB MNFD W/FM. REG BY,PR, SHT OFF	5039.58	98602-3-433EC-3	430 3WY MNFD W/FM, REG BY, STR, 3WAY SHTF	4235.97
98601-8-437EC-3FB	430 FB MNFD W/FM. REG BY,PR, SHT OFF	5039.58	98602-3-435EC-3	430 3WY MNFD W/FM, REG BY, STR, 3WAY SHTF	5177.19
98601-9-433EC-3FB	430 MANIFOLD	1934.40	98602-30-433EC-3-D	98602-30-433EC-3-D	2212.05
98601-9-434EC-3FB	430 MANIFOLD	2290.05	98602-4-433EC-3	430 3WY MNFD W/ REG BY,PR	1886.04
98601-9-435EC-3FB	430 MANIFOLD	2620.15	98602-4-437EC-3	430 3WY MNFD W/REG BY, PR	3454.78
98601-A-431EC-3FB	430 3FB MNFD W/PR	556.48	98602-4-439EC-3	430 2WY MNFD W/REG BY, PR	4217.87
98601-A-432EC-3FB	430 3FB MNFD W/PR	865.24	98602-5-435EC-3	430 3WY MNFD W/FM	3150.35
98601-A-433EC-3FB	430 3FB MNFD W/PR	1174.31	98602-7-432EC-3	430 3WY MNFD WREG BY, STR	1660.85
98601-A-434EC-3FB	430 FB MNFD W/PR	1504.21	98602-7-433EC-3	430 3WY MNFD WREG BY, STR	2041.90
98601-A-435EC-3FB	430 FB MNFD W/PR	1834.27	98602-7-434EC-3	430 3WY MNFD WREG BY, STR	2424.67
98601-A-436EC-3FB	430 FB MNFD W/PR	2175.31	98602-7-435EC-3	430 3WY MNFD WREG BY, STR	2834.70
98601-A-437EC-3FB	430 FB MNFD W/PR	2494.22			
98601-A-438EC-3FB	430 FB MNFD W/PR	2823.90			
98601-B-433EC-3FB	430 3FB MNFD W/STR, REG BY, PR	1757.34			

PART NO.	DESCRIPTION	U.S.DOLLARS	PART NO.	DESCRIPTION	U.S.DOLLARS
98602-9-433EC-3	430 3WY MNFD W/FM, REG BY, STR, 3 WAY SHTF	4073.13	AA110-3/8-300	PRES.RELIEF VALVE,BR	83.22
98602-A-430EC-3	430 3WY RPLC	382.33	AA110-3/8-50	PRES.RELIEF CTRL. BR	83.22
98602-A-433E-3	430 E 3WY MNFD W/PR	1354.90	AA110-3/8-700	PRES.RELIEF VALVE,BR	83.22
98602-A-433EC-3	430 3WY MNFD W/PR	1354.90	AA110-3/8-HSS-1000	PRES.REL.VLVE.BR-HSS	115.77
98602-A-434EC-3	430 3WY MNFD W/PR	1779.10	AA110-3/8-HSS-1200	PRES.REL.VLVE.BR-HSS	142.18
98602-A-435EC-3	430 3WY MNFD W/PR	2160.60	AA110-3/8-HSS-300	PRES.REL.VLVE,BR-HSS	110.50
98602-A-437EC-3	430 3WY MNFD W/PR	2923.64	AA110-3/8-HSS-700	PRES.REL.VLVE,BR-HSS	110.50
98602-A-439EC-3	430 3WY MNFD W/PR	3686.73	AA111-1	CLAMP ASB.VARI-SPAC.	6.83
98602-B-430EC-3	430 3WY RPLC	382.33	AA111-1-1/4	CLAMP ASB.VARI-SPAC.	11.41
98602-B-431EC-3	430 3WY MNFD W/STR, REG BY, PR	1161.75	AA111-1/2	CLAMP ASB.VARI-SPAC.	6.83
98602-B-432EC-3	430 3WY MNFD W/STR, REG BY, PR	1549.83	AA111-3/4	CLAMP ASB.VARI-SPAC.	6.83
98602-B-433E-3	430 3WY MNFD W/STR, REG BY, PR	1937.92	AA111SQ-1	CLAMP ASB,VARI-SPAC.	7.84
98602-B-433EC-3	430 3WY MNFD W/STR, REG BY, PR	1937.92	AA111SQ-1-1/2	CLAMP ASB.VARI-SPAC.	14.01
98602-B-434EC-3	430 3WY MNFD W/STR, REG BY, PR	2333.60	AA111SQ-1-1/4	CLAMP ASB.VARI-SPAC.	11.79
98602-B-435EC-3	430 3WY MNFD W/STR, REG BY, PR	2743.61	AA12-10	GUNJET SPRAY GUN	178.72
98602-B-436EC-3	430 3WY MNFD W/STR, REG BY, PR	2897.07	AA12-12	GUNJET SPRAY GUN	178.72
98602-B-437EC-3	430 3WY MNFD W/STR, REG BY, PR	3506.68	AA12-2	GUNJET SPRAY GUN	178.72
98602-B-439EC-3	430 3WY MNFD W/STR, REG BY, PR	4269.76	AA12-3	GUNJET SPRAY GUN	178.72
98602-C-430EC-3	430 3WY RPLC	382.33	AA12-4	GUNJET SPRAY GUN	178.72
98602-C-431EC-3	430 3WY MNFD W/FM, STR, REG BY, PR	2163.80	AA12-5	GUNJET SPRAY GUN	178.72
98602-C-432EC-3	430 3WY MNFD W/FM, STR, REG BY, PR	2553.42	AA12-6	GUNJET SPRAY GUN	178.72
98602-C-433EC-3	430 3WY MNFD W/FM, STR, REG BY, PR	2921.59	AA12-8	GUNJET SPRAY GUN	178.72
98602-C-434EC-3	430 3WY MNFD W/FM, STR, REG BY, PR	3317.25	AA12-AL10	GUNJET SPRAY GUN	159.85
98602-C-435EC-3	430 3WY MNFD W/FM,STR,REG BY,PR	3727.29	AA12-AL2	GUNJET SPRAY GUN	159.85
98602-C-436EC-3	430 3WY MNFD W/FM, STR, REG BY, PR	4098.81	AA12-AL4	GUNJET SPRAY GUN	159.85
98602-C-437EC-3	430 3WY MNFD W/FM, STR, REG BY, PR	4490.35	AA12-AL5	GUNJET SPRAY GUN	159.85
98602-C-438EC-3	430 3WY MNFD W/FM, STR, REG BY, PR	4871.86	AA12-AL6	GUNJET SPRAY GUN	159.85
98602-C-439EC-3	430 3WY MNFD W/FM, STR, REG BY, PR	5253.42	AA12-AL8	GUNJET SPRAY GUN	159.85
AA110-1	PRES.RELIEF VALVE,BR	368.07	AA122-1/2-NYC-100	#100 MESH TRAFFIC GREEN 1/2" NPT, CLEAR BOWL	33.59
AA110-1-1/2	PRES.RELIEF VALVE,BR	378.11	AA122-1/2-NYC-16	#16 MESH 1/2" NPT, .CLEAR BOWL	33.59
AA110-1-1/2-AL	PRES.RELIEF VALVE,AL	256.30	AA122-1/2-NYC-200	#200 MESH 1/2" NPT STR.CLEAR BOWL	33.59
AA110-1-1/2-DI	PRES.REL.VALVE,DU.IR	295.81	AA122-1/2-NYC-30	#30 MESH 1/2" NPT, .CLEAR BOWL	33.59
AA110-1-1/4	PRES.RELIEF VALVE,BR	378.11	AA122-1/2-NYC-50	#50 MESH GENTIAN BLUE 1/2" NPT.CLEAR BOWL	33.59
AA110-1-1/4-AL	PRES.RELIEF VALVE,AL	256.30	AA122-1/2-NYC-80	#80 MESH ZINC YELLOW 1/2"NPT, CLEAR BOWL	33.59
AA110-1-1/4-DI	PRES.REL.VALVE,DU.IR	295.81	AA122-1/2-PP-100	#100 MESH SCREEN TRAFFIC GREEN STR.POLYPRO,NPT	26.69
AA110-1-AL	PRES.RELIEF VALVE,AL	236.49	AA122-1/2-PP-16	#16 MESH SCREEN BROWN RED STR. POLYPRO,NPT	26.69
AA110-1-DI	PRES.REL.VALVE,DU.IR	284.95	AA122-1/2-PP-200	#200 MESH SCREEN STR. POLYPRO,NPT	33.63
AA110-1/4-1000	PRES.RELIEF VALVE BR	89.07	AA122-1/2-PP-30	#30 MESH SCREEN FLAME RED STR. POLYPRO,NPT	26.69
AA110-1/4-150	PRES.RELIEF VALVE,BR	83.22	AA122-1/2-PP-50	50 MESH SCREEN GENTIAN BLUE STR. POLYPRO,NPT	26.69
AA110-1/4-300	PRES.RELIEF VALVE,BR	83.22	AA122-1/2-PP-80	80 MESH SCREEN ZINC YELLOW STR. POLYPRO,NPT	26.69
AA110-1/4-50	PRES.RELIEF VALVE BR	83.22	AA122-3/4-NYC-100	#100 MESH SCREEN STRAIN. NYLON	33.59
AA110-1/4-700	PRES.RELIEF VALVE,BR	83.22	AA122-3/4-NYC-16	#16 MESH SCREEN STRAIN. NYLON	33.59
AA110-1/4-HSS-1000	PRES.REL.VLVE.BR-HSS	115.77	AA122-3/4-NYC-200	#200 mesh screen STRAIN.NYLON	33.59
AA110-1/4-HSS-300	PRES.REL.VLVE,BR-HSS	110.50	AA122-3/4-NYC-30	#30 MESH SCREEN STRAIN. NYLON	33.59
AA110-1/4-HSS-700	PRES.REL.VLVE,BR-HSS	110.50	AA122-3/4-NYC-50	#50 MESH SCREEN STRAIN. NYLON	33.59
AA110-3/8-1000	PRES.RELIEF VALVE BR	89.07	AA122-3/4-NYC-80	#80 MEH SCREEN STRAIN.NYLON	33.59
AA110-3/8-150	PRES.RELIEF VALVE BR	83.22	AA122-3/4-PP-100	#100 MESH SCREEN STRAINER POLYPRO	26.69
			AA122-3/4-PP-16	#16 MESH SCREEN STRAINER PP-NPT	26.69

PART NO.	DESCRIPTION	U.S.DOLLARS	PART NO.	DESCRIPTION	U.S.DOLLARS
AA122-3/4-PP-200	#200 MESH SCREEN STRAINER POLYPRO	33.63	AA124-2-1/2-AL-50	STRAINER ALUM,&NYLON	485.24
AA122-3/4-PP-30	#30 MESH SCREEN STRAINER POLYPRO	26.69	AA124-2-1/2-AL-80	STRAINER ALUM,&NYLON	485.24
AA122-3/4-PP-50	#50 MESH SCREEN STRAINER POLYPRO	26.69	AA124-2-1/2-I-16	STRAINER,C.I.&NYLON	485.24
AA122-3/4-PP-80	#80 MESH SCREEN STRAINER POLYPRO	26.69	AA124-2-1/2-I-30	STRAINER,C.I.&NYLON	485.24
AA122ML-1/2-PP-100	#100 MESH SCREEN TRAFFIC GREEN 1/2"STR, POLYPRO.NPT	29.08	AA124-2-1/2-I-50	STRAINER,C.I.&NYLON	485.24
AA122ML-1/2-PP-16	#16 MESH SCREEN BROWN RED 1/2"STR, POLYPRO.NPT	29.08	AA124-2-1/2-I-80	STRAINER,C.I.&NYLON	485.24
AA122ML-1/2-PP-200	#200 MESH SCREEN 1/2"STR, POLYPRO.NPT	36.95	AA124-2-AL-100	STRAINER,ALUM&NYLON	462.14
AA122ML-1/2-PP-30	#30 MESH SCREEN FLAME RED 1/2"STR, POLYPRO.NPT	29.08	AA124-2-AL-16	STRAINER,ALUM&NYLON	485.24
AA122ML-1/2-PP-50	#50 MESH SCREEN GENTIAN BLUE 1/2"STR, POLYPRO.NPT	29.08	AA124-2-AL-30	STRAINER,ALUM&NYLON	485.24
AA122ML-1/2-PP-80	#80 MESH SCREEN ZINC YELLOW 1/2"STR, POLYPRO.NPT	29.08	AA124-2-AL-50	STRAINER,ALUM&NYLON	485.24
AA122ML-3/4-PP-100	#100 MESH SCREEN TRAFFIC GREEN 3/4"STR, POLYPRO-NPT	29.08	AA124-2-AL-80	STRAINER,ALUM&NYLON	485.24
AA122ML-3/4-PP-16	#16 MESH SCREEN BROWN RED 3/4"STR, POLYPRO-NPT	29.08	AA124-2-I-10	STRAINER,C.I.&NYLON	485.24
AA122ML-3/4-PP-200	#200 MESH SCREEN 3/4"STR, POLYPRO-NPT	36.95	AA124-2-I-16	STRAINER,C.I.&NYLON	485.24
AA122ML-3/4-PP-30	#30 MESH SCREEN FLAME RED 3/4"STR, POLYPRO-NPT	29.08	AA124-2-I-30	STRAINER,C.I.&NYLON	485.24
AA122ML-3/4-PP-50	#50 MESH SCREEN GENTIAN BLUE 3/4"STR, POLYPRO-NPT	29.08	AA124-2-I-50	STRAINER,C.I.&NYLON	485.24
AA122ML-3/4-PP-80	#80 MESH SCREEN ZINC YELLOW 3/4"STR, POLYPRO-NPT	29.08	AA124-2-I-80	STRAINER,C.I.&NYLON	485.24
AA122ML-QC-PP-100	#100 MESH SCREEN TRAFFIC GREEN STR-NPT W/LUG	54.33	AA124A-1-AL-100	STRAINER ALUM.&NYLON	136.09
AA122ML-QC-PP-50	#50 MESH SCREEN GENTIAN BLUE STR-NPT W/LUG	54.33	AA124A-1-AL-16	STRAINER ALUM,&NYLON	136.09
AA122ML-QC-PP-80	#80 MESH SCREEN ZINC YELLOW STR-NPT W/LUG	54.33	AA124A-1-AL-200	STRAINER ALUM.&NYLON	132.76
AA124-1-1/2-AL-100	STRAINER,ALUM.&NYLON	211.64	AA124A-1-AL-30	STRAINER ALUM,&NYLON	136.09
AA124-1-1/2-AL-16	STRAINER,ALUM.&NYLON	211.64	AA124A-1-AL-50	STRAINER ALUM,&NYLON	136.09
AA124-1-1/2-AL-30	STRAINER,ALUM.&NYLON	211.64	AA124A-1-AL-80	STRAINER ALUM,&NYLON	136.09
AA124-1-1/2-AL-50	STRAINER,ALUM.&NYLON	211.64	AA124A-1-I-100	STRAINER C.I.&NYLON	137.12
AA124-1-1/2-AL-80	STRAINER,ALUM.&NYLON	211.64	AA124A-1-I-16	STRAINER C.I.&NYLON	137.12
AA124-1-1/2-I-100	STRAINER C.I.&NYLON	213.87	AA124A-1-I-30	STRAINER C.I.&NYLON	137.12
AA124-1-1/2-I-16	STRAINER,C.I.& NYLON	213.87	AA124A-1-I-50	STRAINER C.I.&NYLON	137.12
AA124-1-1/2-I-30	STRAINER,C.I.& NYLON	213.87	AA124A-1-I-80	STRAINER C.I.&NYLON	137.12
AA124-1-1/2-I-50	STRAINER,C.I.& NYLON	213.87	AA124A-1SC-AL-30	SELF CLEAN STR.ALUM.	170.04
AA124-1-1/2-I-80	STRAINER,C.I.& NYLON	213.87	AA124A-1SC-AL-50	SELF CLEAN STR.ALUM.	170.04
AA124-1-1/2SC-AL-30	SELF CLEAN STR ALUM.	294.48	AA124A-1SC-AL-80	SELF CLEAN STR.ALUM.	170.04
AA124-1-1/2SC-AL-50	SELF CLEAN STR ALUM.	294.48	AA124A-3/4-AL-100	STRAINER ALUM,&NYLON	136.09
AA124-1-1/2SC-AL-80	SELF CLEAN STR ALUM.	294.48	AA124A-3/4-AL-16	STRAINER ALUM,&NYLON	136.09
AA124-1-1/4-AL-100	STRAINER,ALUM.&NYLON	211.64	AA124A-3/4-AL-200	STRAINER ALUM,&NYLON	136.09
AA124-1-1/4-AL-120	STRAINER,ALUM.&NYLON	211.64	AA124A-3/4-AL-30	STRAINER ALUM,&NYLON	136.09
AA124-1-1/4-AL-16	STRAINER,ALUM.&NYLON	211.64	AA124A-3/4-AL-50	STRAINER ALUM,&NYLON	136.09
AA124-1-1/4-AL-30	STRAINER,ALUM.&NYLON	211.64	AA124A-3/4-AL-80	STRAINER ALUM,&NYLON	136.09
AA124-1-1/4-AL-50	STRAINER,ALUM.&NYLON	211.64	AA124A-3/4-I-100	STRAINER C.I.&NYLON	137.12
AA124-1-1/4-AL-80	STRAINER,ALUM.&NYLON	211.64	AA124A-3/4-I-16	STRAINER C.I.&NYLON	137.12
AA124-1-1/4-I-16	STRAINER,C.I.& NYLON	213.87	AA124A-3/4-I-30	STRAINER C.I.&NYLON	137.12
AA124-1-1/4-I-30	STRAINER,C.I.& NYLON	213.87	AA124A-3/4-I-50	STRAINER C.I.&NYLON	137.12
AA124-1-1/4-I-50	STRAINER,C.I.& NYLON	213.87	AA124A-3/4-I-80	STRAINER C.I.&NYLON	137.12
AA124-1-1/4-I-80	STRAINER,C.I.& NYLON	213.87	AA124A-3/4SC-AL-30	SELF CLEAN STR.ALUM.	170.04
AA124-1-1/4SC-AL-30	SELF CLEAN STR ALUM.	294.48	AA124A-3/4SC-AL-50	SELF CLEAN STR.ALUM.	170.04
AA124-1-1/4SC-AL-50	SELF CLEAN STR ALUM.	294.48	AA124A-3/4SC-AL-80	SELF CLEAN STR.ALUM.	170.04
AA124-1-1/4SC-AL-80	SELF CLEAN STR ALUM.	294.48	AA124ML-1-1/2-AL-16	STRAINER W/LUG ALUM.	245.53
AA124-2-1/2-AL-16	STRAINER ALUM,&NYLON	485.24	AA124ML-1-1/2-AL-30	STRAINER W/LUG ALUM.	245.53
AA124-2-1/2-AL-30	STRAINER ALUM,&NYLON	485.24	AA124ML-1-1/2-AL-50	STRAINER W/LUG ALUM.	245.53
			AA124ML-1-1/2-AL-80	STRAINER W/LUG ALUM.	245.53
			AA124ML-1-1/2SC-AL-100	STRAINER W/LUG ALUM.	341.58
			AA124ML-1-1/2SC-AL-30	STRAINER W/LUG ALUM.	341.58
			AA124ML-1-1/2SC-AL-50	STRAINER W/LUG ALUM.	341.58
			AA124ML-1-1/2SC-AL-80	STRAINER W/LUG ALUM.	341.58
			AA124ML-1-1/4-AL-16	STRAINER W/LUG ALUM.	245.53
			AA124ML-1-1/4-AL-30	STRAINER W/LUG ALUM.	245.53
			AA124ML-1-1/4-AL-50	STRAINER W/LUG ALUM.	245.53
			AA124ML-1-1/4-AL-80	STRAINER W/LUG ALUM.	245.53
			AA124ML-1-1/4SC-AL-100	STRAINER W/LUG ALUM.	341.58
			AA124ML-1-1/4SC-AL-30	STRAINER W/LUG ALUM.	341.58
			AA124ML-1-1/4SC-AL-50	STRAINER W/LUG ALUM.	341.58
			AA124ML-1-1/4SC-AL-80	STRAINER W/LUG ALUM.	341.58
			AA124ML-1-AL-16	STRAINER W/LUG ALUM.	159.63
			AA124ML-1-AL-30	STRAINER W/LUG ALUM.	159.63
			AA124ML-1-AL-50	STRAINER W/LUG ALUM.	159.63
			AA124ML-1-AL-80	STRAINER W/LUG ALUM.	159.63

PART NO.	DESCRIPTION	U.S.DOLLARS	PART NO.	DESCRIPTION	U.S.DOLLARS
AA124ML-1SC-AL-30	STRAINER W/LUG ALUM.	198.66	AA126ML-5-30	#30 MESH SCREEN FLAME RED 1-1/4"STR-NPT	100.79
AA124ML-1SC-AL-50	STRAINER W/LUG ALUM.	198.66	AA126ML-5-50	#50 MESH SCREEN GENTIAN BLUE 1-1/4" STR-NPT	100.79
AA124ML-1SC-AL-80	STRAINER W/LUG ALUM.	198.66	AA126ML-5-50-VI	#50 MESH SCREEN GENTIAN BLUE 1-1/4"STR. VITON-NPT	114.86
AA124ML-2-1/2-AL-16	STRAINER W/LUG ALUM.	567.20	AA126ML-5-80	#80 MESH SCREEN ZINC YELLOW 1-1/4" STR-NPT	100.79
AA124ML-2-1/2-AL-30	STRAINER W/LUG ALUM.	567.20	AA126ML-6-100	#100 MESH SCREEN TRAFFIC GRENN 1-1/2" STR-NPT	100.79
AA124ML-2-1/2-AL-50	STRAINER W/LUG ALUM.	567.20	AA126ML-6-120	#120 MESH SCREEN BROWN 1-1/2" STR-NPT	100.79
AA124ML-2-1/2-AL-80	STRAINER W/LUG ALUM.	567.20	AA126ML-6-16	#16 MESH SCREEN BROWN RED 1-1/2" STR-NPT	100.79
AA124ML-2-AL-100	STRAINER W/LUG ALUM.	567.20	AA126ML-6-16-VI	#16 MESH SCREEN BROWN RED 1-1/2" STR-NPT. VITON	114.86
AA124ML-2-AL-16	STRAINER W/LUG ALUM.	567.20	AA126ML-6-30	#30 MESH SCREEN FLAME RED 1-1/2" STR-NPT	100.79
AA124ML-2-AL-30	STRAINER W/LUG ALUM.	567.20	AA126ML-6-50	#50 MESH SCREEN GENTIAN BLUE 1-1/2" STR-NPT	100.79
AA124ML-2-AL-50	STRAINER W/LUG ALUM.	567.20	AA126ML-6-80	#80 MESH SCREEN ZINC YELLOW 1-1/2" STR-NPT	100.79
AA124ML-2-AL-80	STRAINER W/LUG ALUM.	567.20	AA126ML-F50-100	FLANGED STRAINER	49.26
AA124ML-3/4-AL-16	STRAINER W/LUG ALUM.	159.63	AA126ML-F50-16	FLANGED STRAINER	49.26
AA124ML-3/4-AL-30	STRAINER W/LUG ALUM.	159.63	AA126ML-F50-20	FLANGED STRAINER	49.26
AA124ML-3/4-AL-50	STRAINER W/LUG ALUM.	159.63	AA126ML-F50-200	FLANGED STRAINER	49.26
AA124ML-3/4-AL-80	STRAINER W/LUG ALUM.	159.63	AA126ML-F50-30	FLANGED STRAINER	49.26
AA124ML-3/4SC-AL-30	STRAINER W/LUG ALUM.	198.66	AA126ML-F50-50	50 MESH GENTIAN BLUE FLANGED STRAINER	49.26
AA124ML-3/4SC-AL-50	STRAINER W/LUG ALUM.	198.66	AA126ML-F50-80	FLANGED STRAINER	49.26
AA124ML-3/4SC-AL-80	STRAINER W/LUG, ALUM	198.66	AA126ML-F75-100	FLANGED STRAINER	100.79
AA126ML-3-100	#100 MESH SCREEN TRAFFIC GREEN 3/4" STR.NPT	49.26	AA126ML-F75-120	FLANGED STRAINER	100.79
AA126ML-3-100-VI	#100 MESH SCREEN TRAFFIC GREEN 3/4" STRAINER VITON.NPT	61.13	AA126ML-F75-16	FLANGED STRAINER	100.79
AA126ML-3-16	#16 MESH BROWN RED 3/4" STR. NPT	49.26	AA126ML-F75-16-VI	FLANGE 16MESH VITON	114.86
AA126ML-3-20	#20 MESH SCREEN BEIGE 3/4" STRAINER.NPT	49.26	AA126ML-F75-30	FLANGED STRAINER	100.79
AA126ML-3-200	#200 MESH SCREEN LIGHT PINK 3/4" STRAINER.NPT	49.26	AA126ML-F75-50	FLANGED STRAINER	100.79
AA126ML-3-30	#30 MESH SCREEN FLAME RED 3/4" STRAINER.NPT	49.26	AA126ML-F75-50-VI	FLANGED STRAINER VI	114.86
AA126ML-3-30-VI	#30 MESH SCREEN FLAME RED 3/4" STRAINER VITON.NPT	61.13	AA126ML-F75-80	FLANGED STRAINER	100.79
AA126ML-3-50	3/4" STRAINER ASB-NPT W/50 MESH GENTIAN BLUE	49.26	AA126ML-F75-80-VI	FLANGED STRAINER VI	114.86
AA126ML-3-50-VI	#50 MESH SCREEN GENTIAN BLUE 3/4" STRAINER VITON.NPT	61.13	AA126ML-M50-100	#100 MESH STRAINER, PP-NPT	49.26
AA126ML-3-80	#80 MESH SCREEN ZINC YELLOW 3/4" STRAINER.NPT	49.26	AA126ML-M50-100-VI	430 50 STRAINER VITON	61.13
AA126ML-3-80-VI	#80 MESH SCREEN ZINC YELLOW 3/4" STRAINER,VITON.NPT	61.13	AA126ML-M50-16	430 50 STRAINER	49.26
AA126ML-4-100	#100 MESH SCREEN TRAFFIC GREEN 1" STRAINER-NPT	49.26	AA126ML-M50-16-VI	430 50 STRAINER VITON	61.13
AA126ML-4-16	#16 MESH SCREEN BROWN RED 1" STRAINER-NPT	49.26	AA126ML-M50-20	430 50 STRAINER	49.26
AA126ML-4-20	#20 MESH SCREEN BEIGE 1" STRAINER-NPT	49.26	AA126ML-M50-20-VI	430 50 STRAINER VITON	61.13
AA126ML-4-200	#200 MESH SCREEN LIGHT PINK 1" STRAINER-NPT	49.26	AA126ML-M50-200	430 50 STRAINER	49.26
AA126ML-4-30	#30 MESH SCREEN FLAME RED 1" STRAINER-NPT	49.26	AA126ML-M50-200-VI	430 50 STRAINER VITON	61.13
AA126ML-4-30-VI	#30 MESH SCREEN FLAME RED 1" STRAINER-NPT, VITON	61.13	AA126ML-M50-30	430 50 STRAINER	49.26
AA126ML-4-50	#50 MESH SCREEN GENTIAN BLUE 1" STRAINER -NPT	49.26	AA126ML-M50-30-VI	430 50 STRAINER VITON	61.13
AA126ML-4-50-VI	#50 MESH SCREEN GENTIAN BLUE 1" STRAINER-NPT, VITON	61.13	AA126ML-M50-50	#50 MESH STRAINER, NPT.PP	49.26
AA126ML-4-80	#80 MESH SCREEN ZINC YELLOW 1" STRAINER -NPT	49.26	AA126ML-M50-50-VI	50 MESH STRAINER W/VITON	61.13
AA126ML-5-100	#100 MESH SCREEN TRAFFIC GREEN 1-1/4" STR-NPT	100.79	AA126ML-M50-80	80 MESH ZINC YELLOW STR.NPT	49.26
AA126ML-5-120	#120 MESH SCREEN BROWN 1-1/4" STR-NPT	100.79	AA126ML-M50-80-VI	#80 MESH STRAINER,PP W/VITON GASKET	61.13
AA126ML-5-16	#16 MESH SCREEN BROWN RED 1-1/4" STR-NPT	100.79	AA126MLSC-3-100	#100 MESH SCREEN 3/4" STR-NPT-SELF CLEAN	76.14
AA126ML-5-16-VI	#16 MESH SCREEN BROWN RED 1-1/4" STR. VITON-NPT	114.86	AA126MLSC-3-16	#16 MESH SCREEN 3/4"STR-NPT SELF CLEAN	76.14
			AA126MLSC-3-200	#200 MESH SCREEN 3/4"STR-NP, SELF CLEAN	76.14
			AA126MLSC-3-30	#30 MESH SCREEN 3/4"STR-NPT,SELF CLEAN	76.14
			AA126MLSC-3-50	#50 MESH SCREEN 3/4"STR-NPT,SELF CLEAN	76.14
			AA126MLSC-3-50-VI	#50 MESH SCREEN 3/4"STR-VITON. NPT,SELF CLEAN	125.18



PART NO.	DESCRIPTION	U.S.DOLLARS	PART NO.	DESCRIPTION	U.S.DOLLARS
AA126MLSC-3-80	#80 MESH SCREEN 3/4"STR-NPT. SELF CLEAN	76.14	AA144A-1-3	DIRECTOVALVE,3 WAY	316.87
AA126MLSC-3-80-VI	#80 MESH SCREEN 3/4"STR-VITON. NPT SELF CLEAN	127.69	AA144A-1-3-VI	DIRECTOVALVE,3WAY,VI	359.75
AA126MLSC-4-100	SELF CLEAN STR 1"	76.14	AA144A-1-VI	DIRECTOVALVE W/VITON	274.38
AA126MLSC-4-16	SELF CLEAN STRAIN 1"	76.14	AA144A-2	DIRECTOVALVE,POLYPRO	471.74
AA126MLSC-4-16-VI	SELF CLEAN STRAIN 1"	127.69	AA144A-2-3	DIRECTOVALVE, 3 WAY	638.84
AA126MLSC-4-200	SELF CLEAN STR 1"	76.14	AA144A-2-VI	DIRECTOVALVE W/VITON	549.33
AA126MLSC-4-50	SELF CLEAN STR 1"	76.14	AA144A-3	DIRECTOVALVE,POLYPRO	710.65
AA126MLSC-4-80	SELF CLEAN STR 1"	76.14	AA144A-3-3	DIRECTOVALVE,3 WAY	960.82
AA126MLSC-5-100-VI	SELF CLEAN STR 1-1/4	127.69	AA144A-3-3-VI	DIRECTOVALVE,3WAY,VI	1073.99
AA126MLSC-5-16-VI	SELF CLEAN STR 1-1/4	127.69	AA144A-3-VI	DIRECTOVALVE W/VITON	824.39
AA126MLSC-5-30-VI	SELF CLEAN STR 1-1/4	127.69	AA144F-1-3	DIRECTOVALVE, 3 WAY	260.94
AA126MLSC-5-50-VI	SELF CLEAN STR 1-1/4	127.69	AA144P-1	DIRECTOVALVE	320.94
AA126MLSC-5-80-VI	SELF CLEAN STR 1-1/4	127.69	AA144P-1-3	3 WAY DIRECTOVALVE	383.67
AA126MLSC-6-100-VI	SELF CLEAN STR 1-1/2	127.69	AA144P-2	DIRECTOVALVE	641.75
AA126MLSC-6-16-VI	SELF CLEAN STR 1-1/2	127.69	AA144P-2-3	3 WAY DIRECTOVALVE	767.21
AA126MLSC-6-30-VI	SELF CLEAN STR 1-1/2	127.69	AA144P-3	DIRECTOVALVE	962.51
AA126MLSC-6-50-VI	SELF CLEAN STR 1-1/2	127.69	AA144P-3-3	3 WAY DIRECTOVALVE	1150.68
AA126MLSC-6-80-VI	SELF CLEAN STR 1-1/2	127.69	AA144P-3-45630-1	144P MANIFOLD LOCTITE	962.51
AA126MLSC-F50-100	SELF CLEAN STR FLANG	76.14	AA145H-1	DIRECTOVALVE,NYLON	533.16
AA126MLSC-F50-16	SELF CLEAN STR FLANG	76.14	AA145H-1-VI	DIRECTOVALVE W/VITON	576.44
AA126MLSC-F50-50	SELF CLEAN STR FLANG	76.14	AA17L	TEEVALVE 3/4" INLET	194.53
AA126MLSC-F50-80	SELF CLEAN STR FLANG	76.14	AA17Y	TEEVALVE 1" INLET	194.53
AA126MLSC-F75-16-VI	SELF CLEAN STR FLANG	127.69	AA18-10	GUNJET SPRAY GUN	170.13
AA126MLSC-F75-50-VI	SELF CLEAN STR FLANG	127.69	AA18-2	GUNJET SPRAY GUN	170.13
AA126MLSC-F75-80-VI	SELF CLEAN STR FLANGE	127.69	AA18-3	GUNJET SPRAY GUN	170.13
AA126MLSC-M50-100	SELF CLEAN STR 430 50	76.14	AA18-4	GUNJET SPRAY GUN	170.13
AA126MLSC-M50-100-VI	SELF CLEAN STR VITON 430 50	127.69	AA18-6	GUNJET SPRAY GUN	170.13
AA126MLSC-M50-16	SELF CLEAN STR 430 50	76.14	AA18-AL10	GUNJET SPRAY GUN	120.82
AA126MLSC-M50-16-VI	SELF CLEAN STR VITON 430 50	127.69	AA18-AL2	GUNJET SPRAY GUN	120.82
AA126MLSC-M50-20	SELF CLEAN STR 430 50	76.14	AA18-AL3	GUNJET SPRAY GUN	120.82
AA126MLSC-M50-20-VI	SELF CLEAN STR VITON 430 50	127.69	AA18-AL4	GUNJET SPRAY GUN	120.82
AA126MLSC-M50-200	SELF CLEAN STR 430 50	76.14	AA18-AL5	GUNJET SPRAY GUN	120.82
AA126MLSC-M50-200-VI	SELF CLEAN STR VITON 430 50	127.69	AA18-AL6	GUNJET SPRAY GUN	120.82
AA126MLSC-M50-30	SELF CLEAN STR 430 50	76.14	AA18-AL7	GUNJET SPRAY GUN	120.82
AA126MLSC-M50-30-VI	SELF CLEAN STR VITON 430 50	127.69	AA18-AL8	GUNJET SPRAY GUN	120.82
AA126MLSC-M50-50	SELF CLEAN STR 430 50	76.14	AA2-120	GUNJET SPRAY GUN	264.39
AA126MLSC-M50-50-VI	SELF CLEAN STR VITON 430 50	127.69	AA2-180	GUNJET SPRAY GUN	264.39
AA126MLSC-M50-80	SELF CLEAN STR 430 50	76.14	AA2-20	GUNJET SPRAY GUN	264.39
AA126MLSC-M50-80-VI	SELF CLEAN STR VITON 430 50	127.69	AA2-30	GUNJET SPRAY GUN	264.39
AA12A-10	GUNJET SPRAY GUN	164.12	AA2-45	GUNJET SPRAY GUN	264.39
AA12A-16	GUNJET SPRAY GUN	164.12	AA2-60	GUNJET SPRAY GUN	264.39
AA12A-2	GUNJET SPRAY GUN	164.12	AA2-90	GUNJET SPRAY GUN	264.39
AA12A-3	GUNJET SPRAY GUN	164.12	AA2-AL120	GUNJET SPRAY GUN	183.15
AA12A-4	GUNJET SPRAY GUN	164.12	AA2-AL180	GUNJET SPRAY GUN	183.15
AA12A-5	GUNJET SPRAY GUN	164.12	AA2-AL20	GUNJET SPRAY GUN	183.15
AA12A-6	GUNJET SPRAY GUN	164.12	AA2-AL30	GUNJET SPRAY GUN	183.15
AA12A-8	GUNJET SPRAY GUN	164.12	AA2-AL45	GUNJET SPRAY GUN	183.15
AA12C-GH-3/4	GUNJET SPRAY GUN	111.91	AA2-AL60	GUNJET SPRAY GUN	183.15
AA143-AL-3/4-10	GUNJET SPRAY GUN	136.42	AA2-AL90	GUNJET SPRAY GUN	183.15
AA143-AL-3/4-2	GUNJET SPRAY GUN	136.42	AA23H	GUNJET SPRAY GUN	105.98
AA143-AL-3/4-4	GUNJET SPRAY GUN	136.42	AA23H-12085-18	GUNJET SPRAY GUN	327.38
AA143-AL-3/4-6	GUNJET SPRAY GUN	136.42	AA23H-12085-24	GUNJET SPRAY GUN	327.38
AA143-AL-3/4-8	GUNJET SPRAY GUN	136.42	AA23H-12085-36	GUNJET SPRAY GUN	327.38
AA143-AL-GH-10	GUNJET SPRAY GUN	136.42	AA23H-12085-8	GUNJET SPRAY GUN	327.38
AA143-AL-GH-12	GUNJET SPRAY GUN	136.42	AA23H-17526	GUNJET SPRAY GUN	108.88
AA143-AL-GH-2	GUNJET SPRAY GUN	136.42	AA23L	GUNJET SPRAY GUN	103.09
AA143-AL-GH-3	GUNJET SPRAY GUN	136.42	AA23L-7676-18	GUNJET SPRAY GUN	163.20
AA143-AL-GH-4	GUNJET SPRAY GUN	136.42	AA23L-7676-24	GUNJET SPRAY GUN	172.98
AA143-AL-GH-5	GUNJET SPRAY GUN	136.42	AA23L-7676-36	GUNJET SPRAY GUN	186.93
AA143-AL-GH-6	GUNJET SPRAY GUN	136.42	AA23L-7676-48	GUNJET SPRAY GUN	222.58
AA143-AL-GH-8	GUNJET SPRAY GUN	136.42	AA23L-7676-8	GUNJET SPRAY GUN	153.09
AA144A-1	DIRECTOVALVE,POLYPRO	232.88	AA23PC-18-20	GUNJET SPRAY GUN	155.80
			AA23PC-8-20	GUNJET SPRAY GUN	145.08
			AA2A-120	GUNJET SPRAY GUN	217.88



# COMPREHENSIVE LIST

PART NO.	DESCRIPTION	U.S.DOLLARS	PART NO.	DESCRIPTION	U.S.DOLLARS
AA2A-180	GUNJET SPRAY GUN	217.88	AA344M-2M-3/4	BALL VALVE ASSEMBLY	109.23
AA2A-20	GUNJET SPRAY GUN	217.88	AA344M-3-1	BALL VALVE ASSEMBLY	108.60
AA2A-30	GUNJET SPRAY GUN	217.88	AA344M-3-1-PP	BALL VALVE ASB.	81.98
AA2A-45	GUNJET SPRAY GUN	217.88	AA344M-3-3/4	BALL VALVE ASSEMBLY	108.60
AA2A-60	GUNJET SPRAY GUN	217.88	AA344M-3-3/4-PP	BALL VALVE ASB.	81.98
AA2A-90	GUNJET SPRAY GUN	217.88	AA344M-3-F	FLANGED BALL VALVE	108.60
AA2A-AL180	GUNJET SPRAY GUN	167.70	AA344M-3-Q	QUICK CONNECT BALL VALVE	108.60
AA2A-AL20	GUNJET SPRAY GUN	167.70	AA346M-2-1-1/2-PP	BALL VALVE ASSEMBLY	108.89
AA2A-AL30	GUNJET SPRAY GUN	167.70	AA346M-2-1-1/4-PP	BALL VALVE ASSEMBLY	108.89
AA2A-AL45	GUNJET SPRAY GUN	167.70	AA346M-2-F-PP	MAN.FLANGED BALLVALV	108.89
AA2A-AL60	GUNJET SPRAY GUN	167.70	AA346M-2-F75-PP	MAN. FLNGED BALLVLV	108.89
AA2A-AL90	GUNJET SPRAY GUN	167.70	AA346M-3-1-1/2-PP	BALL VALVE ASSEMBLY	132.03
AA30-1/4	GUNJET SPRAY GUN	94.62	AA346M-3-1-1/4-PP	BALL VALVE ASSEMBLY	132.03
AA30-1/4-VI	GUNJET W/VITON PACK.	103.12	AA346M-3-F-PP	MAN.FLANGED BALVALVE	132.03
AA30-20940	GUNJT.VARIABLE SPRAY	176.82	AA346M-3-F75-PP	MAN.FLANGED BALVALVE	132.03
AA30A-1/4	A VERSION GUNJET	94.62	AA36-1/4	SPRAYGUN BRASS	104.41
AA30A-1/4-VI	A VERS. GUNJET/VITON	103.12	AA36-1/4-SS	SPRAYGUN ST.STL.	290.45
AA30A-50736	A VER.VARISPRAY GNJT	176.82	AA36-3/8	SPRAYGUN BRASS	104.41
AA30AW-1/4	A VERSION GUNJET	89.50	AA36-3/8-SS	SPRAYGUN ST. STL.	290.45
AA30L-1/4	GUNJET SPRAY GUN	94.62	AA43-11767-1/2	GUNJET SPRAY GUN	286.31
AA30L-1/4-VI	GUNJET W/VITON PACK	103.12	AA43-11767-1/4	GUNJET SPRAY GUN	286.31
AA30L-22425-18	GUNJET W/EXTENSION	158.94	AA43-11767-3/8	GUNJET SPRAY GUN	286.31
AA30L-22425-24	GUNJET W/EXTENSION	168.47	AA43-12605	GUNJET SPRAY GUN	312.82
AA30L-22425-30	GUNJET W/30 IN EXT	189.41	AA43-12605-SS	GUNJET SPRAYGUN,SS	572.17
AA30L-22425-36	GUNJET W/EXTENSION	193.52	AA43H-10	GUNJET SPRAY GUN	254.68
AA30L-22425-48	GUNJET W/EXTENSION	217.88	AA43H-12	GUNJET SPRAY GUN	254.68
AA30L-22425-8	GUNJET W/EXTENSION	149.16	AA43H-14	GUNJET SPRAY GUN	254.68
AA30L-PP	GUNJET ASB.POLYPRO.	78.49	AA43H-16	GUNJET SPRAY GUN	254.68
AA30W-1/4	GUNJET SPRAY GUN	89.50	AA43H-2	GUNJET SPRAY GUN	254.68
AA31	GUNJET SPRAY GUN	111.00	AA43H-4	GUNJET SPRAY GUN	254.68
AA31-1/4F	GUNJET SPRAY GUN	111.00	AA43H-5	GUNJET SPRAY GUN	254.68
AA31-1/4F-12090-18	GUNJET SPRYGUN,W/EXT	214.26	AA43H-6	GUNJET SPRAY GUN	254.68
AA31-1/4F-12090-24	GUNJET SPRAYGUN W/EX	239.63	AA43H-7	GUNJET SPRAY GUN	254.68
AA31-1/4F-9525-36	GUNJT.SPRAYGUN W/EXT	175.64	AA43H-8	GUNJET SPRAY GUN	254.68
AA31-12090-18	GUNJET SPRYGUN,W/EXT	214.26	AA43H-AL10	GUNJET SPRAY GUN	211.59
AA31-12090-24	GUNJET SPRYGUN,W/EXT	239.63	AA43H-AL12	GUNJET SPRAY GUN	211.59
AA31-12090-36	GUNJET SPRYGUN,W/EXT	310.88	AA43H-AL14	GUNJET SPRAY GUN	211.59
AA31-12090-8	GUNJET SPRYGUN,W/EXT	173.84	AA43H-AL16	GUNJET SPRAY GUN	211.59
AA31-18099	GUNJET SPRAY GUN	97.30	AA43H-AL2	GUNJET SPRAY GUN	211.59
AA31-7715-18	GUNJET SPRAYGUN,W/EXT	169.06	AA43H-AL3	GUNJET SPRAY GUN	211.59
AA31-7715-24	GUNJET SPRAYGUN,W/EXT	194.42	AA43H-AL4	GUNJET SPRAY GUN	211.59
AA31-9525-18	GUNJET SPRAY GUN	154.08	AA43H-AL5	GUNJET SPRAY GUN	211.59
AA31-9525-24	GUNJET SPRAY GUN	160.12	AA43H-AL6	GUNJET SPRAY GUN	211.59
AA31-9525-36	GUNJET SPRAY GUN	175.64	AA43H-AL8	GUNJET SPRAY GUN	211.59
AA31-9525-48	GUNJET SPRAY GUN	188.91	AA43HA-10	GUNJET SPRAY GUN	230.76
AA31-9525-8	GUNJET SPRAY GUN	145.25	AA43HA-12	GUNJET SPRAY GUN	230.76
AA31TL	GUNJET SPRAY GUN	100.52	AA43HA-14	GUNJET SPRAY GUN	230.76
AA31TL-1/4F	GUNJET SPRAY GUN	100.52	AA43HA-16	GUNJET SPRAY GUN	230.76
AA343M-2-1/2-PP	BALL VALVE ASB.POLYP	66.19	AA43HA-2	GUNJET SPRAY GUN	230.76
AA343M-2-3/8-PP	BALL VALVE ASB.POLYP	66.19	AA43HA-4	GUNJET SPRAY GUN	230.76
AA343M-3-1/2-PP	BALL VALVE ASB.POLYP	80.02	AA43HA-5	GUNJET SPRAY GUN	230.76
AA343M-3-3/8-PP	BALL VALVE ASB.POLYP	80.02	AA43HA-6	GUNJET SPRAY GUN	230.76
AA344M-2-0	BALL VALVE ASEMBLY	28.68	AA43HA-7	GUNJET SPRAY GUN	230.76
AA344M-2-1	BALLVALVE ASSEMBLY	89.81	AA43HA-8	GUNJET SPRAY GUN	230.76
AA344M-2-1-PP	BALL VALVE ASSEMBLY, 1"NPT	67.77	AA43HA-AL10	GUNJET SPRAY GUN	202.67
AA344M-2-3/4	BALL VALVE ASSEMBLY	89.81	AA43HA-AL12	GUNJET SPRAY GUN	202.67
AA344M-2-3/4-PP	BALL VALVE ASSEMBLY	67.77	AA43HA-AL14	GUNJET SPRAY GUN	202.67
AA344M-2-B1	430 MANUAL BALL VALVE	84.55	AA43HA-AL2	GUNJET SPRAY GUN	202.67
AA344M-2-B3/4	430 MANUAL BALL VALVE	84.55	AA43HA-AL4	GUNJET SPRAY GUN	202.67
AA344M-2-BF	430 MANUAL BALL VALVE	84.55	AA43HA-AL5	GUNJET SPRAY GUN	202.67
AA344M-2-BQ	430 MANUAL BALL VALVE	84.55	AA43HA-AL6	GUNJET SPRAY GUN	202.67
AA344M-2-F	FLANGED BALLVALVE	89.81	AA43HA-AL8	GUNJET SPRAY GUN	202.67
AA344M-2-Q	MANUAL BALL VALVE	89.81	AA43HB	GUNJET,LESS CAP &TIP	206.34
AA344M-2M-1	MANUAL BALL VALVE	109.23	AA43HB-AL	GUNJET,LESS CAP &TIP	193.23

PART NO.	DESCRIPTION	U.S.DOLLARS	PART NO.	DESCRIPTION	U.S.DOLLARS
AA43HC-1/2	GUNJET SPRAYGUN,BR.	204.81	AA500TLW	TEEJET EYL.T.BDY.ASB.	5.70
AA43HC-1/2-AL	GUNJET SPRAYGUN,AL.	191.66	AA6B	DIRECTOVALVE	76.61
AA43HC-1/2-SS	GUNJET SPRAYGUN,SS	430.14	AAB110-1	PRES RELIEF VLV.BSPT	368.07
AA43HC-3/4	GUNJET SPRAYGUN,BR.	204.81	AAB110-1-1/2	PRES RELIEF VLV.BSPT	378.11
AA43HC-3/4-AL	GUNJET SPRAYGUN,AL.	191.66	AAB110-1-1/2-AL	P.R. VALVE BSPT.ALUM	313.65
AA43HD	GUNJET,LESS CAP &TIP	204.81	AAB110-1-1/4	PRES RELIEF VLV.BSPT	378.11
AA43HD-AL	GUNJET, AL	191.66	AAB110-1-1/4-AL	PRES.REL.VLV.BSPT.AL	256.30
AA43L-1	GUNJET SPRAY GUN	254.68	AAB110-1-AL	P.R. VALVE,BSPT,ALUM	236.49
AA43L-10	GUNJET SPRAY GUN	254.68	AAB110-1/4-300	PRES.RELIEF VALVE,BR	83.22
AA43L-12	GUNJET SPRAY GUN	254.68	AAB110-1/4-700	PRES.REL.VLVE.BSPT,BR	83.22
AA43L-16	GUNJET SPRAY GUN	254.68	AAB110-3/8-150	PRES.RELIEF VALVE BR	83.22
AA43L-2	GUNJET SPRAY GUN	254.68	AAB122-1/2-NYC-100	1/2" STRAINER W/#100 MESH TRAFFIC GREEN-BSPT,CLEAR BOWL	33.59
AA43L-4	GUNJET SPRAY GUN	254.68	AAB122-1/2-NYC-16	1/2" W/#16 MESH STRAIN.NYLON BSPT-CLEAR BOWL	33.59
AA43L-5	GUNJET SPRAY GUN	254.68	AAB122-1/2-NYC-30	1/2" W/#30 MESH STRAIN.NYLON BSPT-CLEAR BOWL	33.59
AA43L-6	GUNJET SPRAY GUN	254.68	AAB122-1/2-NYC-50	1/2" STRAINER W/#50 MESH GENTIAN BLUE BSPT, CLEAR BOWL	33.59
AA43L-8	GUNJET SPRAY GUN	254.68	AAB122-1/2-NYC-80	1/2" STRAINER W/#80 MESH ZINC YELLOW, CLEAR BOWL	33.59
AA43L-AL10	GUNJET SPRAY GUN	211.59	AAB122-1/2-PP-100	#100 MESH SCREEN TRAFFIC GREEN STR.POLYPRO,BSPT	26.69
AA43L-AL2	GUNJET SPRAY GUN	211.59	AAB122-1/2-PP-16	#16 MESH SCREEN BROWN RED STR.POLYPRO,BSPT	26.69
AA43L-AL4	GUNJET SPRAY GUN	211.59	AAB122-1/2-PP-200	#200 MESH SCREEN STR. POLYPRO,BSPT	33.63
AA43L-AL5	GUNJET SPRAY GUN	211.59	AAB122-1/2-PP-30	#30 MESH SCREEN FLAME RED STR, POLYPRO,BSPT	26.69
AA43L-AL6	GUNJET SPRAY GUN	211.59	AAB122-1/2-PP-50	#50 MESH SCREEN GENTIAN BLUE STR.POLYPRO,BSPT	26.69
AA43L-AL8	GUNJET SPRAY GUN	211.59	AAB122-1/2-PP-80	#80 MESH SCREEN ZINC YELLOW STR.POLYPRO,BSPT	26.69
AA43LA-10	GUNJET SPRAY GUN	230.73	AAB122-3/4-NYC-100	#100 MESH STRAIN.NYLON BSPT- CLEAR BOWL	33.59
AA43LA-12	GUNJET SPRAY GUN	230.73	AAB122-3/4-NYC-16	#16 MESH STRAIN.NYLON BSPT- CLEAR BOWL	33.59
AA43LA-14	GUNJET SPRAY GUN	230.73	AAB122-3/4-NYC-30	#30 MESH STRAIN.NYLON BSPT- CLEAR BOWL	33.59
AA43LA-2	GUNJET SPRAY GUN	230.73	AAB122-3/4-NYC-50	#50 MESH STRAIN.NYLON BSPT- CLEAR BOWL	33.59
AA43LA-4	GUNJET SPRAY GUN	230.73	AAB122-3/4-NYC-80	#80 MESH STRAIN.NYLON BSPT- CLEAR BOWL	33.59
AA43LA-6	GUNJET SPRAY GUN	230.73	AAB122-3/4-PP-100	#100 MESH SCREEN TRAFFIC GREEN 3/4"STR,BSPT	26.69
AA43LA-7	GUNJET SPRAY GUN	230.73	AAB122-3/4-PP-16	#16 MESH SCREEN BROWN RED 3/4"STR.,BSPT	26.69
AA43LA-8	GUNJET SPRAY GUN	230.73	AAB122-3/4-PP-200	#200 MESH CSREEN 3/4"STR,BSPT	33.63
AA43LA-AL10	GUNJET SPRAY GUN	202.67	AAB122-3/4-PP-30	#30 MESH SCREEN FLAME RED 3/4" STR,BSPT	26.69
AA43LA-AL14	GUNJET SPRAY GUN	202.67	AAB122-3/4-PP-50	#50 MESH SCREEN GENTIAN BLUE 3/4" STR.ASB.BSPT.	26.69
AA43LA-AL2	GUNJET SPRAY GUN	202.67	AAB122-3/4-PP-80	#80 MESH SCREEN ZINC YELLOW 3/4"STR.ASB.BSPT.	26.69
AA43LA-AL4	GUNJET SPRAY GUN	202.67	AAB122ML-1/2-NYC-100	#100 MESH SCREEN STR ABS, BSPT, NYC	33.59
AA43LA-AL5	GUNJET SPRAY GUN	202.67	AAB122ML-1/2-NYC-50	#50 MESH SCREEN STR BSPT ASB, NYC	33.59
AA43LA-AL6	GUNJET SPRAY GUN	202.67	AAB122ML-1/2-NYC-80	#80 MESH SCREEN STR ABS, BSPT, NYC	33.59
AA43LA-AL7	GUNJET SPRAY GUN	202.67	AAB122ML-1/2-PP-100	#100 MESH SCREEN TRAFFIC GREEN 1/2"STR, POLYPRO-BSPT	29.08
AA43LA-AL8	GUNJET SPRAY GUN	202.67	AAB122ML-1/2-PP-16	#16 MESH SCREEN BROWN RED 1/2"STR.POLYPRO-BSPT	29.08
AA43LB	GUNJET,LESS CAP &TIP	206.34	AAB122ML-1/2-PP-200	#200 MESH SCREEN 1/2"STR, POLYPRO-BSPT	36.95
AA43LB-AL	GUNJET,LESS CAP &TIP	193.23			
AA43LC-1/2	GUNJET SPRAYGUN,BR.	204.81			
AA43LC-1/2-AL	GUNJET SPRAYGUN,AL.	191.66			
AA43LC-1/2-SS	GUNJET SPRAYGUN SS	430.14			
AA43LC-3/4	GUNJET SPRAYGUN,BR.	204.81			
AA43LC-3/4-AL	GUNJET SPRAYGUN,AL.	191.66			
AA43LD	GUNJET,LESS CAP &TIP	191.41			
AA43LD-AL	GUNJET,LESS CAP &TIP	179.14			
AA441M-4-4T-4T	BALL VALVE	205.47			
AA442M-3-4T-4T	2 VALVE MANIFOLD	453.08			
AA442M-4-4T-4T	2 VALVE MANIFOLD	453.08			
AA442M-Q-4T-4T	2 VALVE MANIFOLD	453.08			
AA443M-3-4T-4T	3 VALVE MANIFOLD	546.15			
AA443M-3-4T-B	AA443M-3-4T-4T MANIFOLD BALL VALVE ASB	546.15			
AA443M-4-4T-4T	3 VALVE MANIFOLD	546.15			
AA443M-4-5H-5H	MANUAL BALLVALVE MAN	546.15			
AA443M-Q-4H-B	3 VALVE MANIFOLD	546.15			
AA443M-Q-5H-5H	MANUAL BALLVALVE	546.15			
AA444M-3-4T-4T	BALL VALVE ASSEMBLY	716.65			
AA444M-4-4T-4T	BALL VALVE ASSEMBLY	716.65			
AA444M-Q-B-4T	BALL VALVE ASSEMBLY	716.65			
AA445M-3-4T-4T	BALL VALVE ASSEMBLY	895.76			
AA445M-4-4T-4T	BALL VALVE ASSEMBLY	895.76			
AA500T	TEEJET EYL.T.BDY.ASB.	18.83			

PART NO.	DESCRIPTION	U.S.DOLLARS	PART NO.	DESCRIPTION	U.S.DOLLARS
AAB122ML-1/2-PP-30	#30 MESH SCREEN FLAME RED 1/2"STR, POLYPRO-BSPT	29.08	AAB124A-1SC-AL-50	SELF CLEAN STR.ALUM.	170.04
AAB122ML-1/2-PP-50	#50 MESH SCREEN GENTIAN BLUE 1/2"STR, POLYPRO-BSPT	29.08	AAB124A-1SC-AL-80	SELF CLEAN STR.ALUM.	170.04
AAB122ML-1/2-PP-80	#80 MESH SCREEN ZINC YELLOW 1/2"STR, POLYPRO-BSPT	29.08	AAB124A-3/4-AL-100	STRAINER BSPT,AL &NY	136.11
AAB122ML-3/4-PP-100	#100 MESH SCREEN TRAFFIC GREEN 3/4"STR, POLYPRO-BSPT	29.08	AAB124A-3/4-AL-16	STRAINER BSPT,AL &NY	136.11
AAB122ML-3/4-PP-30	#30 MESH SCREEN FLAME RED 3/4"STR, POLYPRO-BSPT	29.08	AAB124A-3/4-AL-30	STRAINER BSPT,AL &NY	136.11
AAB122ML-3/4-PP-50	3/4 BSPT STRAINER HEAD,W/50 MESH GENTIAN BLUE, PP-	29.08	AAB124A-3/4-AL-50	STRAINER BSPT,AL &NY	136.11
AAB122ML-3/4-PP-80	#80 MESH SCREEN ZINC YELLOW 3/4"STR, POLYPRO-BSPT	29.08	AAB124A-3/4-AL-80	STRAINER BSPT,AL &NY	136.11
AAB124-1-1/2-AL-100	STRAINER,BSPT,AL&NY	211.64	AAB124A-3/4-I-16	STRAINER BSPT,CI &NY	142.62
AAB124-1-1/2-AL-16	STRAINER,BSPT,AL&NY	211.64	AAB124A-3/4-I-30	STRAINER BSPT,CI &NY	142.62
AAB124-1-1/2-AL-30	STRAINER,BSPT,AL&NY	211.64	AAB124A-3/4-I-50	STRAINER BSPT,CI &NY	142.62
AAB124-1-1/2-AL-50	STRAINER,BSPT,AL&NY	211.64	AAB124A-3/4-I-80	STRAINER BSPT,CI &NY	142.62
AAB124-1-1/2-AL-80	STRAINER,BSPT,AL&NY	211.64	AAB124A-3/4SC-AL-30	SELF CLEAN STR.ALUM.	170.04
AAB124-1-1/2-I-16	STRAINER,BSPT,C.I&NY	222.43	AAB124A-3/4SC-AL-50	SELF CLEAN STR.ALUM.	170.04
AAB124-1-1/2-I-30	STRAINER,BSPT,C.I&NY	222.43	AAB124A-3/4SC-AL-80	SELF CLEAN STR.ALUM.	170.04
AAB124-1-1/2-I-50	STRAINER,BSPT,C.I&NY	222.43	AAB124ML-1-1/2-AL-50	STRAINER W/LUG BSPT	245.53
AAB124-1-1/2-I-80	STRAINER,BSPT,C.I&NY	222.43	AAB124ML-1-1/2-AL-80	STRAINER W/LUG BSPT	245.53
AAB124-1-1/2SC-AL-100	SELF CLEAN STR BSPT	294.48	AAB124ML-1-1/2SC-AL-100	STRAINER W/LUG AL BSPT	341.58
AAB124-1-1/2SC-AL-30	SELF CLEAN STR BSPT	294.48	AAB124ML-1-1/2SC-AL-50	STRNR.W/LUG AL.BSPT	341.58
AAB124-1-1/2SC-AL-50	SELF CLEAN STR BSPT	294.48	AAB124ML-1-1/2SC-AL-80	STRNR.W/LUG AL.BSPT	341.58
AAB124-1-1/2SC-AL-80	SELF CLEAN STR BSPT	294.48	AAB124ML-1-1/4-AL-16	STRAINER W/LUG BSPT	245.53
AAB124-1-1/4-AL-16	STRAINER,BSPT,AL&NY	211.64	AAB124ML-1-1/4-AL-50	STRAINER W/LUG BSPT	245.53
AAB124-1-1/4-AL-30	STRAINER,BSPT,AL&NY	211.64	AAB124ML-1-1/4-AL-80	STRAINER W/LUG BSPT	245.53
AAB124-1-1/4-AL-50	STRAINER,BSPT,AL&NY	211.64	AAB124ML-1-1/4SC-AL-100	STRAINER W/LUG AL BSPT	341.58
AAB124-1-1/4-AL-80	STRAINER,BSPT,AL&NY	211.64	AAB124ML-1-1/4SC-AL-30	STRNR.W/LUG AL.BSPT	341.58
AAB124-1-1/4-I-30	1-1/4 STRAINER BSPT IRON	222.43	AAB124ML-1-1/4SC-AL-50	STRNR.W/LUG AL.BSPT	341.58
AAB124-1-1/4-I-50	STRAINER,BSPT,C.I&NY	222.43	AAB124ML-1-1/4SC-AL-80	STRNR.W/LUG AL.BSPT	341.58
AAB124-1-1/4-I-80	STRAINER,BSPT,C.I&NY	222.43	AAB124ML-1-AL-200	STR.BSPT.W/LUG,ALUM.	159.63
AAB124-1-1/4SC-AL-30	SELF CLEAN STR BSPT	294.48	AAB124ML-1-AL-50	STRAINER W/LUG BSPT	159.63
AAB124-1-1/4SC-AL-50	SELF CLEAN STR BSPT	294.48	AAB124ML-1-AL-80	STR.BSPT.W/LUG,ALUM.	159.63
AAB124-1-1/4SC-AL-80	SELF CLEAN STR BSPT	294.48	AAB124ML-1SC-AL-30	STRAINER W/LUG ALUM.	198.66
AAB124-2-1/2-AL-16	STRAINER BSPT,AL &NY	489.29	AAB124ML-1SC-AL-50	STRAINER W/LUG ALUM.	198.66
AAB124-2-1/2-AL-30	STRAINER BSPT,AL &NY	489.29	AAB124ML-1SC-AL-80	STRAINER W/LUG ALUM.	198.66
AAB124-2-1/2-AL-50	STRAINER BSPT,AL &NY	489.29	AAB124ML-2-1/2-AL-16	STR BSPT W/LUG, ALUM	567.20
AAB124-2-1/2-AL-80	STRAINER BSPT,AL &NY	489.29	AAB124ML-2-1/2-AL-50	STR.BSPT.W/LUG,ALUM.	567.20
AAB124-2-1/2-I-16	STRAINER BSPT,CI &NY	489.29	AAB124ML-2-AL-100	STR.BSPT.W/LUG,ALUM.	567.20
AAB124-2-1/2-I-30	STRAINER BSPT,CI &NY	489.29	AAB124ML-2-AL-50	STR.BSPT.W/LUG,ALUM.	567.20
AAB124-2-1/2-I-50	STRAINER BSPT,CI &NY	489.29	AAB124ML-2-AL-80	STR.BSPT.W/LUG,ALUM.	567.20
AAB124-2-1/2-I-80	STRAINER BSPT,CI &NY	489.29	AAB124ML-3/4-AL-50	STRAINER BSPT.ALUM.	159.63
AAB124-2-AL-100	STRAINER BSPT,AL&NY	489.29	AAB124ML-3/4-AL-80	STR.BSPT.W/LUG,ALUM.	159.63
AAB124-2-AL-16	STRAINER BSPT,AL &NY	489.29	AAB124ML-3/4SC-AL-30	STRAINER W/LUG ALUM.	198.66
AAB124-2-AL-30	STRAINER BSPT,AL &NY	489.29	AAB124ML-3/4SC-AL-50	STRAINER W/LUG ALUM.	198.66
AAB124-2-AL-50	STRAINER BSPT,AL &NY	489.29	AAB124ML-3/4SC-AL-80	STRAINER W/LUG ALUM.	198.66
AAB124-2-AL-80	STRAINER BSPT,AL &NY	489.29	AAB126ML-3-100	126ML-3/4" STRAINER,W/100 MESH TRAFFIC GREEN, BSPT,PP	49.26
AAB124-2-AL-NS	STRAINER BSPT,W/O SCR	413.13	AAB126ML-3-16	#16 MESH SCREEN BROWN RED STRAINER 3/4" BSPT	49.26
AAB124-2-I-16	STRAINER BSPT,CI &NY	489.29	AAB126ML-3-200	#200 MESH SCREEN LIGHT PINK 3/4" STRAINER. BSPT	49.26
AAB124-2-I-30	STRAINER BSPT,CI &NY	489.29	AAB126ML-3-30	#30 MESH SCREEN FLAME RED 3/4" STRAINER. BSPT	49.26
AAB124-2-I-50	STRAINER BSPT,CI &NY	489.29	AAB126ML-3-50	126ML-3/4" STRAINER,W/50 MESH GENTIAN BLUE, BSPT,PP	49.26
AAB124-2-I-80	STRAINER BSPT,CI &NY	489.29	AAB126ML-3-80	#80 MESH SCREEN ZINC YELLOW 3/4" STRAINER, BSPT	49.26
AAB124A-1-AL-100	STRAINER,BSPT.AL&NY	136.11	AAB126ML-4-100	126ML-1" STRAINER,W/100 MESH TRAFFIC GREEN, BSPT,PP	49.26
AAB124A-1-AL-16	STRAINER BSPT,AL &NY	136.11	AAB126ML-4-16	#16 MESH SCREEN BROWN RED 1" STR, BSPT	49.26
AAB124A-1-AL-30	STRAINER BSPT,AL &NY	136.11	AAB126ML-4-200	#200 MESH SCREEN LIGHT PINK 1" STR, BSPT	49.26
AAB124A-1-AL-50	STRAINER BSPT,AL &NY	136.11	AAB126ML-4-30	#30 MESH SCREEN FLAME RED 1" STR, BSPT	49.26
AAB124A-1-AL-80	STRAINER BSPT,AL &NY	136.11	AAB126ML-4-50	126ML-1" STRAINER,W/50 MESH GENTIAN BLUE, BSPT,PP	49.26
AAB124A-1-I-16	STRAINER BSPT.CI &NY	142.62			
AAB124A-1-I-30	STRAINER BSPT.CI &NY	142.62			
AAB124A-1-I-50	STRAINER BSPT.CI &NY	142.62			
AAB124A-1-I-80	STRAINER BSPT.CI &NY	142.62			
AAB124A-1SC-AL-30	SELF CLEAN STR.ALUM.	170.04			

PART NO.	DESCRIPTION	U.S.DOLLARS	PART NO.	DESCRIPTION	U.S.DOLLARS
AAB126ML-4-80	1" STRAINER ASB W/#80 MESH SCREEN ZINC YELLOW, BSPT	49.26	AAB126MLSC-6-100-VI	SELF CLEAN STR 1-1/2	127.69
AAB126ML-5-100	126ML-1-1/4" STRAINER,W/100 MESH TRAFFIC GREEN, BSPT,PP	100.79	AAB126MLSC-6-50-VI	SELF CLEAN STR 1-1/2	127.69
AAB126ML-5-120	#120 MESH SCREEN BROWN 1-1/4" STR, BSPT	100.79	AAB126MLSC-6-80-VI	SELF CLEAN STR 1-1/2	127.69
AAB126ML-5-16	#16 MESH SCREEN BROWN RED 1-1/4" STR, BSPT	100.79	AAB126MLSC-F50-100	SELF CLEAN STR FLANG	76.14
AAB126ML-5-30	#30 MESH SCREEN FLAME RED 1-1/4" STR, BSPT	100.79	AAB126MLSC-F50-50	SELF CLEAN STR FLANG	76.14
AAB126ML-5-50	126ML-1-1/4"STRAINER,W/50 MESH GENTIAN BLUE,BSPT,PP	100.79	AAB126MLSC-F75-100-VI	SELF CLEAN STR FLANG	127.69
AAB126ML-5-50-VI	#50 MESH SCREEN GENTIAN BLUE 1-1/4"STR, VITON, BSPT	114.86	AAB126MLSC-F75-30-VI	SELF CLEAN STR FLANG	125.18
AAB126ML-5-80	126ML-1-1/4" STRAINER,W/80 MESH ZINC YELLOW, BSPT,PP	100.79	AAB126MLSC-F75-50-VI	SELF CLEAN STR FLANG	127.69
AAB126ML-6-100	126ML-1-1/2"STRAINER,W/100 MESH TRAFFIC GREEN,BSPT,PP	100.79	AAB126MLSC-F75-80-VI	SELF CLEAN STR FLANG	127.69
AAB126ML-6-120	126ML-1-1/2"STRAINER,W/120 MESH,BSPT,PP	100.79	AAB144A-1	DIRECTOVALVE,BSPT,PP	232.88
AAB126ML-6-16	1-1/2 STRAINER, BSPT	100.79	AAB144A-1-3	DIRECTOVLV,3WAY,BSPT	316.87
AAB126ML-6-30	126ML-1-1/2" STRAINER, W/30 MESH,BSPT,PP	100.79	AAB144A-1-3-VI	DIRECTOVLV,3WAY,BSPT	359.75
AAB126ML-6-50	126ML-1-1/2"STRAINER, W/50 MESH GENTIAN BLUE,BSPT,PP	100.79	AAB144A-1-VI	BSPT DIRECTOVALVE W/VITON	274.38
AAB126ML-6-80	126ML-1-1/2"STRAINER,W/80 MESH ZINC YELLOW,BSPT,PP	100.79	AAB144A-2	DIRECTOVALVE,BSPT,PP	471.74
AAB126ML-F50-100	FLANGE STRAINER,BSPT	49.26	AAB144A-2-3	DIRECTOVALVE, 3 WAY, BSPT	638.84
AAB126ML-F50-16	FLANGE STRAINER,BSPT	49.26	AAB144A-2-VI	DIRECTOVALVE W/VITON	549.33
AAB126ML-F50-200	FLANGE STRAINER,BSPT	49.26	AAB144A-3	DIRECTOVALVE,BSPT,PP	710.65
AAB126ML-F50-30	FLANGE STRAINER,BSPT	49.26	AAB144A-3-3	DIRECTOVLV,3WAY,BSPT	960.82
AAB126ML-F50-50	FLANGE STRAINER,BSPT	49.26	AAB144A-3-3-VI	DIRECTOVLV,3WAY,BSPT	1073.99
AAB126ML-F50-80	FLANGE STRAINER,BSPT	49.26	AAB144A-3-VI	DIRECTOVALVE W/VITON	824.39
AAB126ML-F75-100	FLANGE STRAINER,BSPT	100.79	AAB144F-1-3	BSPT DIRECTOVALVE	260.94
AAB126ML-F75-100-VI	FLANGE STRAINER,BSPT- VITON	113.71	AAB144P-1	DIRECTOVALVE BSPT	320.94
AAB126ML-F75-120	FLANGE STRAINER,BSPT	100.79	AAB144P-1-3	3 WAY DIRECTOVALVE (BSPT)	383.67
AAB126ML-F75-16	FLANGE STRAINER,BSPT	100.79	AAB144P-2	DIRECTOVALVE	641.75
AAB126ML-F75-30	FLANGE STRAINER,BSPT	100.79	AAB144P-2-3	3 WAY DIRECTOVALVE	767.21
AAB126ML-F75-50	FLANGE STRAINER,BSPT	100.79	AAB144P-3	DIRECTOVALVE	962.51
AAB126ML-F75-80	FLANGE STRAINER,BSPT	100.79	AAB144P-3-3	3 WAY DIRECTOVALVE	1150.68
AAB126ML-F75-80-VI	FLANGE STRAINER,BSPT- VITON	113.71	AAB30-1/4	GUNJET BSPT.BRASS	94.62
AAB126ML-M50-100	430 50 STRAINER/BSPT	49.26	AAB30-1/4-VI	GUNJET W/VI PACK BSP	103.12
AAB126ML-M50-100-VI	430 50 STRAINER BSPT/VI	61.13	AAB30-20940	GUNJT.VARIABLE SPRAY	176.82
AAB126ML-M50-16	430 50 STRAINER/BSPT	49.26	AAB30A-1/4	A VERSION GUNJT.BSPT	94.62
AAB126ML-M50-16-VI	430 50 STRAINER BSPT/VI	61.13	AAB30A-50736	A VERS.VARISPR.A.BSPT	176.82
AAB126ML-M50-20	430 50 STRAINER/BSPT	49.26	AAB30AW-1/4	A VERSION GUNJT.BSPT	94.62
AAB126ML-M50-20-VI	430 50 STRAINER BSPT/VI	61.13	AAB30L-1/4	GUNJET SPRAY GUN	94.62
AAB126ML-M50-200	430 50 STRAINER/BSPT	49.26	AAB30L-22425-18	GUNJET BSPT.W/EXT.	158.94
AAB126ML-M50-200-VI	430 50 STRAINER BSPT/VI	61.13	AAB30L-22425-24	GUNJET BSPT.W/EXT.	168.47
AAB126ML-M50-30	430 50 STRAINER/BSPT	49.26	AAB30L-22425-30	GUNJET W/30 IN EXT	189.41
AAB126ML-M50-30-VI	430 50 STRAINER BSPT/VI	61.13	AAB30L-22425-36	GUNJET BSPT.W/EXT.	193.52
AAB126ML-M50-50	430 50 STRAINER/BSPT	49.26	AAB30L-22425-48	GUNJET BSPT.W/EXT.	217.88
AAB126ML-M50-50-VI	430 50 STRAINER BSPT/VI	61.13	AAB30L-22425-8	GUNJET BSPT.W/EXT.	149.16
AAB126ML-M50-80	430 50 STRAINER/BSPT	49.26	AAB30L-PP	GUNJET ASB.BSPT,PP	78.49
AAB126ML-M50-80-VI	430 50 STRAINER BSPT/VI	61.13	AAB30W-1/4	GUNJET BSPT.BRASS	94.62
AAB126MLSC-3-100	#100 MESH SCREEN 3/4"STR-BSPT	76.14	AAB343M-2-1/2-PP	BALL VALVE ASB.POLYP	66.19
AAB126MLSC-3-50	#50 MESH SCREEN 3/4"STR-BSPT	76.14	AAB343M-2-3/8-PP	BALL VALVE ASB.POLYP	66.19
AAB126MLSC-3-80	#80 MESH SCREEN 3/4"STR-BSPT	76.14	AAB343M-3-1/2-PP	BALL VALVE ASB.POLYP	80.02
AAB126MLSC-4-100	SELF CLEAN STR 1"	76.14	AAB343M-3-3/8-PP	BALL VALVE ASB.POLYP	80.02
AAB126MLSC-4-30	SELF CLEAN STR 1"	76.14	AAB344M-2-1	BALL VALVE ASB.BSPT.	89.81
AAB126MLSC-4-50	SELF CLEAN STR 1"	76.14	AAB344M-2-1-PP	BALL VALVE ASSEMBLY	67.77
AAB126MLSC-4-80	SELF CEALN STR 1"	76.14	AAB344M-2-3/4	BALL VALVE ASB.BSPT.	89.81
AAB126MLSC-5-100-VI	SELF CLEAN STR 1-1/4	127.69	AAB344M-2-3/4-PP	BALL VALVE ASSEMBLY	67.77
AAB126MLSC-5-50-VI	SELF CLEAN STR 1-1/4	127.69	AAB344M-2M-1	BALL VALVE ASBY BSPT	109.23
AAB126MLSC-5-80-VI	SELF CLEAN STR 1-1/4	127.69	AAB344M-2M-3/4	BALL VALVE ASBY BSPT	109.23
			AAB344M-3-1	BALL VALVE ASB.BSPT.	108.60
			AAB344M-3-1-PP	BALL VALVE ASB.	81.98
			AAB344M-3-3/4	BALL VALVE ASM BSPT	108.60
			AAB344M-3-3/4-PP	BALL VALVE ASB.	81.98
			AAB346M-2-1-1/2-PP	BALL VALVE ASB.BSPT	108.89
			AAB346M-2-1-1/4-PP	BALL VALVE ASB.BSPT	108.89
			AAB346M-3-1-1/2-PP	BALL VALVE ASB.BSPT	132.03
			AAB346M-3-1-1/4-PP	BALL VALVE ASB.BSPT	132.03
			AAB43H-4	GUNJET BSPT.BRASS	254.68
			AAB43H-6	GUNJET BSPT.BRASS	254.68
			AAB43H-8	GUNJET BSPT.BRASS	254.68
			AAB43H-AL6	GUNJET BSPT.ALUM.	211.59

PART NO.	DESCRIPTION	U.S.DOLLARS	PART NO.	DESCRIPTION	U.S.DOLLARS
AAB43H-AL8	GUNJET BSPT.ALUM.	211.59	AAP124ML-1-1/4SC-AL-80	STRNR.W/LUG AL.BSPP	341.58
AAB43HA-8	GUNJET,BSPT,BRASS	230.76	AAP124ML-1-AL-100	STRAINER W/LUG BSPP.	159.63
AAB43HA-AL6	GUNJET BSPT.ALUM.	202.67	AAP124ML-1-AL-50	STRAINER W/LUG BSPP	159.63
AAB43HA-AL8	GUNJET SP. GUN BSPT	202.67	AAP124ML-3/4-AL-50	STRAINER W/LUG BSPP	159.63
AAB43HC-1/2-AL	GUNJET SPRAYGUN AL	191.66	AAP23H-17526	GUNJET BSPP,BRASS	108.88
AAB43HD	GUNJET BSPT.BRASS	204.81	AAP23L	GUNJET BSPP,BRASS	103.09
AAB43HD-AL	GUNJET,BSPT AL	186.06	AB115880-1-FR-KIT	FIELD REPAIR KIT FOR 115880-1-ECS	201.02
AAB43L-8	GUNJET BSPT.BRASS	254.68	AB115880-1-KIT	SPARE PARTS KIT FOR 115880 ECS	74.16
AAB43L-AL10	GUNJET SPRAY GUN	211.59	AB115880-2-FR-KIT	FIELD REPAIR KIT FOR 115880-2-ECS	201.02
AAB43L-AL2	GUNJET SPRAY GUN	211.59	AB115880-2-KIT	SPARE PARTS KIT FOR 115880 ECS	74.16
AAB43L-AL4	GUNJET SPRAY GUN	211.59	AB115880-4-KIT	SPARE PARTS KIT FOR 115880 ECS	74.16
AAB43L-AL6	GUNJET SPRAY GUN	211.59	AB115880-KIT-KUHN1	115880-2- O-RING KIT	11.10
AAB43L-AL8	GUNJET BSPT.ALUM.	211.59	AB11990-14/16-KIT	REPAIR KIT,SWIVEL	12.70
AAB43LA-6	GUNJET BSPT.BRASS	230.73	AB11990-17/19-KIT	REPAIR KIT,SWIVEL	14.33
AAB43LA-7	GUNJET BSPT.BRASS	230.73	AB11990-20/21-KIT	REPAIR KIT,SWIVEL	12.70
AAB43LA-8	GUNJET,BSPT,BRASS	230.73	AB11990-6/13-KIT	REPAIR KIT,SWIVEL	12.94
AAB43LA-AL2	2 43LA GUNJET ASSEMBLY ALUM. BSPT	202.67	AB11990-60/65-KIT	REPAIR KIT,SWIVEL	5.70
AAB43LA-AL6	GUNJET BSPT.ALUM.	202.67	AB122ML-QC-VI-KIT	122ML-QC STRAINER - SPARE PARTS KIT	20.07
AAB43LA-AL7	GUNJET BSPT.ALUM.	202.67	AB12328-KIT	SPARE PTS.KIT,12328	54.24
AAB43LA-AL8	GUNJET BSPT.ALUM.	202.67	AB12690-KIT	REPAIR KIT,12690	31.11
AAB43LC-1/2	AAB43LC-1/2 GUNJET BSPT	204.81	AB126ML-50-EPR-KIT	126 REPAIR KIT	8.08
AAB43LC-1/2-AL	GUNJET SPRAYGUN AL	191.66	AB126ML-50-VI-KIT	126 REPAIR KIT	20.52
AAB442M-3-4T-4T	2 VALVE MANIFOLD	453.08	AB126ML-F75-EPR-KIT	126 REPAIR KIT EPR	11.05
AAB443M-3-4T-4T	3 VALVE MANIFOLD	546.15	AB126ML-F75-VI-KIT	126 REPAIR KIT VITON	25.09
AAB443M-Q-4T-4T	3 VALVE MANIFOLD	546.15	AB12AS-KIT	SUPER REPAIR KIT,12A	45.84
AAB445M-3-4T-4T	5 VALVE MANIFOLD	875.66	AB12S-AL-KIT	SUPER PTS.KIT,12-AL	52.78
AAB6B	DIRECTOVALVE BSPT	76.61	AB12S-KIT	SUPER REPAIR KIT,12	45.84
AAP110-1-1/2-AL	P.R.VALVE,BSPP,ALUM.	303.93	AB13833-KIT	REPAIR KIT 13833	40.80
AAP110-1-1/4-AL	P.R.VALVE,BSPP,ALUM.	303.93	AB13845-KIT	SPARE PTS.KIT GUNJET	38.79
AAP110-1-AL	P.R.VALVE,BSPP,ALUM.	236.49	AB144P-1-3-KIT	REPAIR KIT	36.38
AAP124-1-1/2-AL-100	STRAINER BSPP,AL&NY	211.64	AB145H-1-KIT	PARTS KIT DIRECTOVLV	94.53
AAP124-1-1/2-AL-30	STRAINER,BSPP,AL &NY	211.64	AB145H-VI-KIT	PARTS KIT DIRECTOVLV	107.97
AAP124-1-1/2-AL-50	STRAINER,BSPP,AL &NY	211.64	AB15950-KIT	SPARE PARTS KIT	38.50
AAP124-1-1/2SC-AL-30	SELF CLEAN STR BSPP	294.48	AB16027-KIT	SPARE PARTS KIT	20.61
AAP124-1-1/2SC-AL-50	SELF CLEAN STR BSPP	294.48	AB2-AL-KIT	REPAIR KIT,AL,GUNJET	62.84
AAP124-1-1/2SC-AL-80	SELF CLEAN STR BSPP	294.48	AB2-KIT	REPAIR KIT,BR,GUNJET	24.32
AAP124-1-1/4-AL-30	STRAINER,BSPP,AL &NY	211.64	AB21550-KIT	SPARE PARTS KIT F/21550	24.09
AAP124-1-1/4-AL-50	STRAINER,BSPP,AL &NY	211.64	AB23240-316SS-316SS-KIT	SPARE PARTS KIT	314.55
AAP124-1-1/4SC-AL-50	SELF CLEAN STR BSPP	294.48	AB23600-1-KIT	METERJET REPAIR KIT	38.73
AAP124-1-1/4SC-AL-80	SELF CLEAN STR BSPP	294.48	AB23600-2-KIT	METERJET REPAIR KIT	38.73
AAP124-2-1/2-AL-30	STRAINER,BSPP,AL &NY	489.29	AB23623-31-KIT	SPARE PARTS KIT	65.45
AAP124-2-1/2-AL-50	STRAINER,BSPP,AL &NY	489.29	AB23624-30L-1/4-KIT	SPARE PARTS KIT	61.44
AAP124-2-1/2-AL-80	STRAINER,BSPP,AL &NY	489.29	AB23770-SS-KIT	SPARE PARTS KIT,SS	38.40
AAP124-2-1/2-I-30	STRAINER BSPP,CI &NY	489.29	AB23990-KIT	SPARE PARTS KIT	8.63
AAP124-2-1/2-I-50	STRAINER BSPP,CI &NY	489.29	AB23H-SS-KIT	SPARE PTS.KIT GUNJET	43.12
AAP124-2-AL-30	STRAINER,BSPP,AL &NY	489.29	AB23L-7676-KIT	PARTS REPAIR KIT	26.00
AAP124-2-AL-50	STRAINER,BSPP,AL &NY	489.29	AB23L-SS-KIT	SPARE PTS.KIT GUNJET	38.47
AAP124-2-AL-80	STRAINER,BSPP,AL &NY	489.29	AB23PC-KIT	SPARE PTS.KIT GUNJET	14.77
AAP124-2-I-16	STRAINER BSPP,CI &NY	489.29	AB24055-KIT	SPARE PARTS KIT	9.84
AAP124-2-I-30	STRAINER BSPP,CI &NY	489.29	AB25-AL-KIT	SUPER REPAIR KIT,2AL	62.46
AAP124-2-I-50	STRAINER BSPP,CI &NY	489.29	AB25-KIT	SUPER REPAIR KIT,2	54.91
AAP124-2-I-80	STRAINER BSPP,CI &NY	489.29	AB30-20940-KIT	SPARE PARTS KIT	60.70
AAP124A-1-AL-16	STRAINER BSPP,AL &NY	136.11	AB30-VI-KIT	GUNJET REPAIR KIT	40.85
AAP124A-1-AL-30	STRAINER BSPP,AL &NY	136.11	AB30A-50736-KIT	A VERS.GUNJET KIT	60.70
AAP124A-1-AL-50	STRAINER BSPP,AL &NY	136.11	AB30A-VI-KIT	A VERSION GUNJT.KIT	40.85
AAP124A-1-AL-80	STRAINER BSPP,AL &NY	136.11	AB30AW-KIT	A VERSION GUNJET KIT	23.74
AAP124A-3/4-AL-16	STRAINER BSPP AL &NY	136.11	AB30L-KIT	30L GUNJT REPAIR KIT	17.44
AAP124A-3/4-AL-30	STRAINER BSPP AL &NY	136.11	AB30L-VI-KIT	30L VITON REPAIR KIT	40.85
AAP124A-3/4-AL-50	STRAINER BSPP AL &NY	136.11	AB30W-KIT	GUNJET REPAIR KIT	23.74
AAP124A-3/4-AL-80	STRAINER BSPP AL &NY	136.11	AB31-9525-KIT	SPARE PTS.KIT,GUNJET	21.73
AAP124A-3/4-I-16	STRAINER BSPP CI &NY	142.62	AB31-KIT	SPARE PTS.KIT,GUNJET	18.42
AAP124A-3/4-I-30	STRAINER BSPP CI &NY	142.62			
AAP124A-3/4-I-80	STRAINER BSPP CI &NY	142.62			

PART NO.	DESCRIPTION	U.S.DOLLARS	PART NO.	DESCRIPTION	U.S.DOLLARS
AB343M-2-PP-KIT	SPARE PARTS KIT	53.07	AB98499-KIT	430 ACC BOLT KIT	10.22
AB343M-3-PP-KIT	SPARE PARTS KIT	63.63	ABAIXR-KIT	AIXR O-RING 25PCS	23.61
AB344-2-KIT	344M-2 REPAIR KIT	54.33	ABCK43-AL-KIT	CONVERSION KIT AL.	38.34
AB344-3-KIT	344M-3 REPAIR KIT	65.60	ABCK43-KIT	CONVERSION KIT BR.	38.34
AB344AE-KIT	344A&B REPAIR KIT	82.19	ABCK43A-AL-KIT	CONVERSION KIT AL.	31.61
AB346B-KIT	SPARE PARTS KIT	73.06	ABCK43A-KIT	CONVERSION KIT BR.	31.61
AB346M-2-PP-KIT	SPARE PARTS KIT	75.07	ABPW4000A-KIT	SPARE PARTS KIT	29.57
AB346M-3-PP-KIT	SPARE PARTS KIT	96.55	ABPW4000AS-KIT	REPAIR KIT	29.57
AB356-KIT	356 TRUN VLV KIT	100.76	ABPW4000ASW-KIT	REPAIR KIT	29.57
AB36-KIT	SPARE PARTS KIT,36	27.53	ABPW4000AW-KIT	SPARE PARTS KIT	29.57
AB36-SS-KIT	REPAIR KIT,36 VLV,SS	28.24	ABQJ370-KIT-1	QJ370 O-RING KIT	25.84
AB43-11767-KIT	SPARE PTS.KIT,GUNJET	37.94	AI110015-VS	TEEJET SPRAY TIP	19.94
AB43-12605-KIT	SPARE PTS.KIT,GUNJET	37.94	AI11002-VS	TEEJET SPRAY TIP	19.94
AB430-KIT	PARTS KIT, 430	53.26	AI110025-VS	TEEJET SPRAY TIP	19.94
AB43B-KIT	SPARE PTS.KIT,GUNJET	12.95	AI11003-VS	TEEJET SPRAY TIP	19.94
AB43BS-KIT	SUPER REPAIR KIT 43B	77.91	AI11004-VS	TEEJET TIP	19.94
AB43C-KIT	SPARE PTS.KIT,GUNJET	12.95	AI11005-VS	TEEJET SPRAY TIP	19.94
AB43CS-KIT	SUPER REPAIR KIT 43C	77.91	AI11006-VS	TEEJET SPRAY TIP	19.94
AB43D-KIT	SPARE PTS.KIT,GUNJET	12.95	AI11008-VS	TEEJET SPRAY TIP	19.94
AB43DS-KIT	SUPER REPAIR KIT 43D	77.91	AI3070-015VP	AI3070 SPRAY TIP	12.29
AB460B-KIT	460/460B REPAIR KIT	87.49	AI3070-015VP-C	AI3070 CAP ASSM W/PLUG	15.38
AB47-11767-KIT	SPARE PTS.KIT GUNJET	75.03	AI3070-025VP	AI3070 SPRAY TIP	12.29
AB47-12605-KIT	SPARE PARTS KIT	75.03	AI3070-025VP-C	AI3070 CAP ASSM W/PLUG	15.38
AB47-KIT	SPARE PARTS KIT 47	78.42	AI3070-02VP	AI3070 SPRAY TIP	12.29
AB47-SS-KIT	SPARE PARTS KIT 47	78.42	AI3070-02VP-C	AI3070 CAP ASSM W/PLUG	15.38
AB530EC-3-KIT	530EC 3-WAY REPAIR KIT	81.54	AI3070-03VP	AI3070 SPRAY TIP	12.29
AB55140-30L-KIT	REPAIR KIT	21.90	AI3070-03VP-C	AI3070 CAP ASSM W/PLUG	15.38
AB55140-30L-VI-KIT	VITON REPAIR KIT	30.33	AI3070-04VP	AI3070 SPRAY TIP	12.29
AB55295-1-KIT	SPARE PARTS AB55295-1-KIT	74.16	AI3070-04VP-C	AI3070 CAP ASSM W/PLUG	15.38
AB55295-2-KIT	SPARE PART AB55295-2-KIT	74.16	AI3070-05VP	AI3070 SPRAY TIP	12.29
AB55295-4-KIT	SPARE PART AB55295-4-KIT	74.16	AI3070-05VP-C	AI3070 CAP ASSM W/PLUG	15.38
AB55300-1-KIT	QJS AIR CHEMSAVER, BODY REPAIR KIT	34.53	AI65025EVS	AI65025EVS VISIFLO TIP CELCON & 303SS SIGNAL VIOLET	20.41
AB55300-2-KIT	AIR CHEMSAVER, PISTON REPAIR KIT	35.76	AI6502EVS	AI6502EVS VISIFLO TIP CELCON & 303SS ZINC YELLOW	20.41
AB55300-3-KIT	AIR CHEMSAVER PISTON	15.57	AI6503EVS	AI6503EVS VISIFLO TIP CELCON & 303SS GENTIAN BLUE	20.41
AB55300-KIT	AIR CHEMSAVER, BODY REPAIR KIT	30.22	AI6504EVS	AI6504EVS VISIFLO TIP CELCON & 303SS FLAME RED	20.41
AB56720-KIT	SPARE PARTS KIT	31.89	AI6505EVS	AI6505EVS VISIFLO TIP CELCON & 303SS NUT BROWN	20.41
AB60-SS-KIT	SPARE PARTS KIT,SS	61.68	AI6506EVS	AI6506EVS VISIFLO TIP CELCON & 303SS SIGNAL GRAY	20.41
AB60W-KIT	SPARE PARTS KIT 60W	41.78	AI80015VS	TEEJET SPRAY TIP	19.94
AB6104-KIT	REPAIR KT,TRIGGER VAL	16.21	AI80025VS	TEEJET SPRAY TIP	19.94
AB6466-KIT	PARTS KIT,TRIG.TEEJT	16.21	AI8002VS	TEEJET SPRAY TIP	19.94
AB6590-KIT	PARTS KIT,TRIG.VALVE	16.21	AI8003VS	TEEJET SPRAY TIP	19.94
AB6815-300-KIT	REPAIR KIT,6815	21.06	AI8004VS	TEEJET SPRAY TIP	19.94
AB6815-50-KIT	REPAIR KIT 6815-50LB	30.85	AI8005VS	TEEJET SPRAY TIP	19.94
AB6815-700-KIT	REPAIR KIT,6815	22.46	AI8006VS	TEEJET SPRAY TIPS	19.94
AB6815-AL-700-KIT	REPAIR KIT,6815-AL	20.63	AI95015EVS	TEEJET SPRAY TIP	20.41
AB6815-AL-HSS-1200-KIT	REP.KIT,6815-AL-HSS	40.41	AI95025EVS	TEEJET SPRAY TIP	20.41
AB6815-AL-HSS-300-KIT	REP.KIT,6815-AL-HSS	28.58	AI9502EVS	TEEJET SPRAY TIP	20.41
AB6815-AL-HSS-700-KIT	REP.KIT,6815-AL-HSS	33.67	AI9503EVS	TEEJET SPRAY TIP	20.41
AB6815-HSS-1200-KIT	REPAIR KIT,6815-HSS	44.12	AI9504EVS	TEEJET SPRAY TIP	20.41
AB6815-HSS-300-KIT	REPAIR KIT,6815-HSS	31.20	AI9505EVS	TEEJET SPRAY TIP	20.41
AB6815-HSS-700-KIT	REPAIR KIT,6815-HSS	36.84	AI9506EVS	TEEJET SPRAY TIP	20.41
AB6815G-300-KIT	REPAIR KIT,6815G	27.88	AI9508EVS	TEEJET SPRAY TIP	20.41
AB6815G-700-KIT	REPAIR KIT,6815G	33.20	AIC110015-VS	TEEJET TIP/CAP AI	21.62
AB6815G-AL-300-KIT	REPAIR KIT,6815G-AL	26.74	AIC110015VS-100-EPR	AI TIP CAP W/ STR	23.36
AB6815G-AL-700-KIT	REPAIR KIT,6815G-AL	31.92	AIC110015VS-100-VI	AI TIP CAP W/ STR	25.69
AB6815G-AL-HSS-300-KIT	REP.KIT,6815G-AL-HSS	69.02	AIC11002-VP	TEEJET TIP/CAP AI	10.02
AB6815G-AL-HSS-700-KIT	REP.KIT,6815G-AL-HSS	74.13	AIC11002-VS	TEEJET TIP/CAP AI	21.62
AB6815G-HSS-300-KIT	REPAIR KIT,6815G-HSS	69.02	AIC110025-VK	TEEJET TIP/CAP AI	17.61
AB6815G-HSS-700-KIT	REPAIR KIT,6815G-HSS	74.13	AIC110025-VP	TEEJET TIP/CAP AI	10.02
AB9840-KIT	PARTS KIT,PR.REL.VLV	27.11			
AB98450-KIT	ROLLOVER VALVE PARTS KIT	14.66			

PART NO.	DESCRIPTION	U.S.DOLLARS	PART NO.	DESCRIPTION	U.S.DOLLARS
AIC110025-VS	TEEJET TIP/CAP AI	21.62	AITTJ60-11008VP-CE	AITTJ60 CE CAP ASSM W/PLUG	17.33
AIC110025VK-50-EPR	AI TIP CAP W/ STR	19.36	AITTJ60-11010VP	AI/TURBO TWINJET	14.08
AIC110025VK-50-VI	AI TIP CAP W/ STR	21.72	AITTJ60-11010VP-CE	AITTJ60 CE CAP ASSM W/PLUG	17.33
AIC110025VP-50-EPR	AI TIP CAP W/ STR	11.74	AITTJ60-11015VP	AI/TURBO TWINJET	14.08
AIC110025VP-50-VI	AI TIP CAP W/ STR	14.10	AITTJ60-11015VP-CE	AITTJ60 CE CAP ASSM W/PLUG	17.33
AIC110025VS-50-EPR	AI TIP CAP W/ STR	23.36	AITXA80015VK	CONEJET TIP CERAMIC	19.94
AIC110025VS-50-VI	AI TIP CAP W/ STR	25.69	AITXA8001VK	CONEJET TIP CERAMIC	19.94
AIC11002VP-50-EPR	AI TIP CAP W/ STR	11.74	AITXA80025VK	CONEJET TIP CERAMIC	19.94
AIC11002VP-50-VI	AI TIP CAP W/ STR	14.10	AITXA8002VK	CONEJET TIP CERAMIC	19.94
AIC11002VS-50-EPR	AI TIP CAP W/ STR	23.36	AITXA8003VK	CONEJET TIP CERAMIC	19.94
AIC11002VS-50-VI	AI TIP CAP W/ STR	25.69	AITXA8004VK	CONEJET TIP CERAMIC	19.94
AIC11003-VK	TEEJET TIP/CAP AI	17.61	AITXB80015VK	CONEJET TIP CERAMIC	19.94
AIC11003-VP	TEEJET TIP/CAP AI	10.02	AITXB8001VK	CONEJET TIP CERAMIC	19.94
AIC11003-VS	TEEJET TIP/CAP AI	21.62	AITXB80025VK	CONEJET TIP CERAMIC	19.94
AIC11003VK-50-EPR	AI TIP CAP W/ STR	19.36	AITXB8002VK	CONEJET TIP CERAMIC	19.94
AIC11003VK-50-VI	AI TIP CAP W/ STR	21.72	AITXB8003VK	CONEJET TIP CERAMIC	19.94
AIC11003VP-50-EPR	AI TIP CAP W/ STR	11.74	AITXB8004VK	CONEJET TIP CERAMIC	19.94
AIC11003VP-50-VI	AI TIP CAP W/ STR	14.10	AIUB85025VS	TEEJET VISIFLO TIP	25.20
AIC11003VS-50-EPR	AI TIP CAP W/ STR	23.36	AIUB8502VS	TEEJET VISIFLO TIP	25.20
AIC11003VS-50-VI	AI TIP CAP W/ STR	25.69	AIUB8503VS	TEEJET VISIFLO TIP	25.20
AIC11004-VK	TEEJET TIP/CAP AI	17.61	AIUB8504VS	TEEJET VISIFLO TIP	25.20
AIC11004-VP	TEEJET TIP/CAP AI	10.02	AIXR110015VK	AIR INDUCTION XR TIP CERAMIC	15.85
AIC11004-VS	TEEJET TIP/CAP AI	21.62	AIXR110015VK-CE	AIXR-VK CAP ASSM W/PLUG	17.62
AIC11004VK-50-EPR	AI TIP CAP W/ STR	19.36	AIXR110015VP	AIR INDUCTION XR TIP	10.87
AIC11004VK-50-VI	AI TIP CAP W/ STR	21.72	AIXR110015VP-CE	AIXR CE CAP ASSM W/PLUG	12.65
AIC11004VP-50-EPR	AI TIP CAP W/ STR	11.74	AIXR110025VK	AIR INDUCTION XR TIP CERAMIC	15.85
AIC11004VP-50-VI	AI TIP CAP W/ STR	14.10	AIXR110025VK-CE	AIXR-VK CAP ASSM W/PLUG	17.62
AIC11004VS-50-EPR	AI TIP CAP W/ STR	23.36	AIXR110025VP	AIR INDUCTION XR TIP	10.87
AIC11004VS-50-VI	AI TIP CAP W/ STR	25.69	AIXR110025VP-CE	AIXR CE CAP ASSM W/PLUG	12.65
AIC11005-VK	TEEJET TIP/CAP AI	17.61	AIXR11002VK	AIR INDUCTION XR TIP CERAMIC	15.85
AIC11005-VP	TEEJET TIP/CAP AI	10.02	AIXR11002VK-CE	AIXR-VK CAP ASSM W/PLUG	17.62
AIC11005-VS	TEEJET TIP/CAP AI	21.62	AIXR11002VP	AIR INDUCTION XR TIP	10.87
AIC11005VK-50-EPR	AI TIP CAP W/ STR	19.36	AIXR11002VP-CE	AIXR CE CAP ASSM W/PLUG	12.65
AIC11005VK-50-VI	AI TIP CAP W/ STR	21.72	AIXR11003VK	AIR INDUCTION XR TIP CERAMIC	15.85
AIC11005VP-50-EPR	AI TIP CAP W/ STR	11.74	AIXR11003VK-CE	AIXR-VK CAP ASSM W/PLUG	17.62
AIC11005VP-50-VI	AI TIP CAP W/ STR	14.10	AIXR11003VP	AIR INDUCTION XR TIP	10.87
AIC11005VS-50-EPR	AI TIP CAP W/ STR	23.36	AIXR11003VP-CE	AIXR CE CAP ASSM W/PLUG	12.65
AIC11005VS-50-VI	AI TIP CAP W/ STR	25.69	AIXR11004VK	AIR INDUCTION XR TIP CERAMIC	15.85
AIC11006-VP	TEEJET TIP/CAP AI	10.02	AIXR11004VK-CE	AIXR-VK CAP ASSM W/PLUG	17.62
AIC11006-VS	TEEJET TIP/CAP AI	21.62	AIXR11004VP	AIR INDUCTION XR TIP	10.87
AIC11006VS-50-EPR	AI TIP CAP W/ STR	23.36	AIXR11004VP-CE	AIXR CE CAP ASSM W/PLUG	12.65
AIC11006VS-50-VI	AI TIP CAP W/ STR	25.69	AIXR11005VK	AIR INDUCTION XR TIP CERAMIC	15.85
AIC11008-VP	TEEJET TIP/CAP AI	10.02	AIXR11005VK-CE	AIXR-VK CAP ASSM W/PLUG	17.62
AIC11008-VS	TEEJET TIP/CAP AI	21.62	AIXR11005VP	AIR INDUCTION XR TIP	10.87
AIC11008VS-50-EPR	AI TIP CAP W/ STR	23.36	AIXR11005VP-CE	AIXR CE CAP ASSM W/PLUG	12.65
AIC11008VS-50-VI	AI TIP CAP W/ STR	25.69	AIXR11006VK	AIR INDUCTION XR TIP CERAMIC	15.85
AIC11010-VP	TEEJET TIP/CAP AI	10.02	AIXR11006VK-CE	AIXR-VK CAP ASSM W/PLUG	17.62
AIC11010-VS	TEEJET TIP/CAP AI	21.62	AIXR11006VP	AIR INDUCTION XR TIP	10.87
AIC11010VS-50-EPR	AI TIP CAP W/ STR	23.36	AIXR11006VP-CE	AIXR CE CAP ASSM W/PLUG	12.65
AIC11010VS-50-VI	AI TIP CAP W/ STR	25.69	AIXR11008VP	AIR INDUCTION XR TIP	12.76
AIC11015-VS	TEEJET TIP/CAP AI	21.62	AIXR11008VP-CE	AIXR CE CAP ASSM W/PLUG	14.52
AITTJ60-110025VP	AI/TURBO TWINJET	12.24	AIXR11010VP	AIR INDUCTION XR TIP	12.76
AITTJ60-110025VP-CE	AITTJ60 CE CAP ASSM W/PLUG	14.22	AIXR11010VP-CE	AIXR CE CAP ASSM W/PLUG	14.52
AITTJ60-11002VP	AI/TURBO TWINJET	12.24	APTJ-110015VP	ACCUPULSE TEEJET TIP	16.83
AITTJ60-11002VP-CE	AITTJ60 CE CAP ASSM W/PLUG	14.22	APTJ-110015VP-CE	ACCUPULSE TEEJET TIP CAP ASSM W/PLUG	18.40
AITTJ60-11003VP	AI/TURBO TWINJET	12.24	APTJ-110015VP-CE-W	ACCUPULSE TEEJET TIP CAP ASSM W/WILGER ADPTR	22.01
AITTJ60-11003VP-CE	AITTJ60 CE CAP ASSM W/PLUG	14.22	APTJ-110025VP	ACCUPULSE TEEJET TIP	16.83
AITTJ60-11004VP	AI/TURBO TWINJET	12.24	APTJ-110025VP-CE	ACCUPULSE TEEJET TIP CAP ASSM W/PLUG	18.40
AITTJ60-11004VP-CE	AITTJ60 CE CAP ASSM W/PLUG	14.22	APTJ-110025VP-CE-W	ACCUPULSE TEEJET TIP CAP ASSM W/WILGER ADPTR	22.01
AITTJ60-11005VP	AI/TURBO TWINJET	12.24	APTJ-11002VP	ACCUPULSE TEEJET TIP	16.83
AITTJ60-11005VP-CE	AITTJ60 CE CAP ASSM W/PLUG	14.22			
AITTJ60-11006VP	AI/TURBO TWINJET	12.24			
AITTJ60-11006VP-CE	AITTJ60 CE CAP ASSM W/PLUG	14.22			
AITTJ60-11008VP	AI/TURBO TWINJET	14.08			



PART NO.	DESCRIPTION	U.S.DOLLARS	PART NO.	DESCRIPTION	U.S.DOLLARS
APTJ-11002VP-CE	ACCUPULSE TEEJET TIP CAP ASSM W/PLUG	18.40	B1/2K-70	FLOODJET NOZ,BSPT,BR	27.79
APTJ-11002VP-CE-W	ACCUPULSE TEEJET TIP CAP ASSM W/WILGER ADPTR	22.01	B1/2K-80	FLOODJET NOZ,BSPT,BR	27.79
APTJ-11003VP	ACCUPULSE TEEJET TIP	16.83	B1/2K-SS40	FLOODJET NOZ,BSPT,SS	46.67
APTJ-11003VP-CE	ACCUPULSE TEEJET TIP CAP ASSM W/PLUG	18.40	B1/2K-SS50	FLOODJET NOZ,BSPT,SS	46.67
APTJ-11003VP-CE-W	ACCUPULSE TEEJET TIP CAP ASSM W/WILGER ADPTR	22.01	B1/2K-SS60	FLOODJET NOZ,BSPT,SS	46.67
APTJ-11004VP	ACCUPULSE TEEJET TIP	16.83	B1/2K-SS70	FLOODJET NOZ,BSPT,SS	46.67
APTJ-11004VP-CE	ACCUPULSE TEEJET TIP CAP ASSM W/PLUG	18.40	B1/2K-SS80	FLOODJET NOZ,BSPT,SS	46.67
APTJ-11004VP-CE-W	ACCUPULSE TEEJET TIP CAP ASSM W/WILGER ADPTR	22.01	B1/2XP40L-VP	XP BOOMJET NOZZLE	89.33
APTJ-11005VP	ACCUPULSE TEEJET TIP	16.83	B1/2XP40R-VP	XP BOOMJET NOZZLE	89.33
APTJ-11005VP-CE	ACCUPULSE TEEJET TIP CAP ASSM W/PLUG	18.40	B1/2XP80L-VP	XP BOOMJET NOZZLE	89.33
APTJ-11005VP-CE-W	ACCUPULSE TEEJET TIP CAP ASSM W/WILGER ADPTR	22.01	B1/2XP80R-VP	XP BOOMJET NOZZLE	89.33
APTJ-11006VP	ACCUPULSE TEEJET TIP	16.83	B1/4B-SS1-1W	WHIRLJET NOZ,BSPT,SS	64.73
APTJ-11006VP-CE	ACCUPULSE TEEJET TIP CAP ASSM W/PLUG	18.40	B1/4B-SS1-5W	WHIRLJET NOZ,BSPT,SS	64.73
APTJ-11006VP-CE-W	ACCUPULSE TEEJET TIP CAP ASSM W/WILGER ADPTR	22.01	B1/4BB-SS5	CHECK VALVE,BSPT,SS	37.94
APTJ-11008VP	ACCUPULSE TEEJET TIP	16.83	B1/4BX-SS1-1W	WHIRLJET NOZ.ST.STL.	80.44
APTJ-11008VP-CE	ACCUPULSE TEEJET TIP CAP ASSM W/PLUG	18.40	B1/4KLC-18	FIELDJET NOZ.BSPT.BR	63.17
APTJ-11008VP-CE-W	ACCUPULSE TEEJET TIP CAP ASSM W/WILGER ADPTR	22.01	B1/4KLC-36	FIELDJET NOZ.,BRASS	63.17
APTJ-11010VP	ACCUPULSE TEEJET TIP	16.83	B1/4KLC-9	1/4KLC-9 FIELDJT NZ,BRASS, BSPT	63.17
APTJ-11010VP-CE	ACCUPULSE TEEJET TIP CAP ASSM W/PLUG	18.40	B1/4KLC-SS18	FIELDJET NOZ.,ST.STL	103.34
APTJ-11010VP-CE-W	ACCUPULSE TEEJET TIP CAP ASSM W/WILGER ADPTR	22.01	B1/4KLC-SS36	FIELDJET NZ, SS, BSPT	103.34
APTJ-11012VP	ACCUPULSE TEEJET TIP	16.83	B1/4KLC-SS5	FEILDJET NOZ.,ST.STL	103.34
APTJ-11012VP-CE	ACCUPULSE TEEJET TIP CAP ASSM W/PLUG	18.40	B1/4KLC-SS9	1/4KLC-SS9 FIELDJET 303SS, BSPT	103.34
APTJ-11012VP-CE-W	ACCUPULSE TEEJET TIP CAP ASSM W/WILGER ADPTR	22.01	B1/4Q-100	STRAINER BSPT.BRASS	26.37
AX-120	ORIFICE INSERT,BRASS	7.78	B1/4Q-50	STRAINER BSPT.BRASS	26.37
AX-20	ORIFICE INSERT,BRASS	7.78	B1/4Q-SS100	STRAINER BSPT.ST.STL	84.11
AX-30	ORIFICE INSERT,BRASS	7.78	B1/4Q-SS50	STRAINER BSPT.ST.STL	84.11
AX-45	ORIFICE INSERT,BRASS	7.78	B1/4XP10L-VP	XP BOOMJET NOZZLE BSPT	75.00
AX-60	ORIFICE INSERT,BRASS	7.78	B1/4XP10R-VP	XP BOOMJET NOZZLE BSPT	75.00
AX-90	ORIFICE INSERT,BRASS	7.26	B1/4XP20L-VP	XP BOOMJET NOZZLE BSPT	75.00
AX-HSS60	ORIFICE INSERT,HSS	14.34	B1/4XP20R-VP	XP BOOMJET NOZZLE BSPT	75.00
AY-HSS120	ORI.INSERT,HSS,2GUN	14.25	B1/4XP25L-VP	XP BOOMJET NOZZLE BSPT	75.00
AY-HSS16	ORI.INSERT,HSS,2GUN	14.25	B1/4XP25R-VP	XP BOOMJET NOZZLE BSPT	75.00
AY-HSS180	ORI.INSERT,HSS,2GUN	14.25	B10314-1/8X1/4	SWIVEL CONN.BSPT.BR.	23.83
AY-HSS20	ORI.INSERT,HSS,2GUN	14.25	B10742A	1/4-19 BSPT DIAPH.CHK VLV #7 SPRING	56.88
AY-HSS240	ORI.INSERT,HSS,2GUN	14.25	B11370-1/4X1/4	JET STABIL.BR.,BSPT.	10.46
AY-HSS30	ORI.INSERT,HSS,2GUN	14.25	B11370-1/8X1/8	JET STABIL.BR.,BSPT.	8.70
AY-HSS45	ORI.INSERT,HSS,2GUN	14.25	B11370-SS-1/4X1/4	JET STABIL.SS.,BSPT.	38.89
AY-HSS60	ORI.INSERT,HSS,2GUN	14.25	B11370-SS-1/8X1/8	JET STABIL.SS.BSPT.	24.52
AY-HSS70	ORI.INSERT,HSS,2GUN	14.25	B11990-8	SWIVEL, BR.BSPT	26.72
AY-HSS90	ORI.INSERT,HSS,2GUN	14.25	B11990-9	SWIVEL, BR.BSPT	26.72
AY-SS120	ORI.INSERT,SS,2GUN	12.82	B12521A-1/2X1/4	SPLIT-EYELET CONN.BR	16.16
AY-SS180	ORI.INSERT,SS,2GUN	12.82	B14643-1/4-IENP	GUNJET ADAP.BSPT.IEN	12.19
AY-SS20	ORI.INSERT,SS,2GUN	12.82	B14643-1/4-SSP	GUNJET ADAP.BSPT.SSP	81.78
AY-SS30	ORI.INSERT,SS,2GUN	12.82	B14643-1/8-SSP	GUNJET ADAP.BSPT.SSP	81.78
AY-SS45	ORI.INSERT,SS,2GUN	12.82	B15250-18-SS	EXTENSION SUB-ASB SS	200.79
AY-SS60	ORI.INSERT,SS,2GUN	12.82	B15950	HIGH PRES.SVV.BSPT	105.22
AY-SS90	ORI.INSERT,SS,2GUN	12.82	B15950-SS	HIGH PRES.SWIVEL S.S	163.24
B1/2K-40	FLOODJET NOZ,BSPT,BR	27.79	B16330-NYVI	SUB-ASB.,244 VALVE	45.21
B1/2K-50	FLOODJET NOZ,BSPT,BR	27.79	B1K-300	FLOODJET NOZ.BSPT.BR	157.19
B1/2K-60	FLOODJET NOZ,BSPT,BR	27.79	B1K-450	FLOODJET NOZ.BSPT.BR	183.92
			B20400-1/4M-18-IENP	EXT. ASBLY,BSPT,IENP	68.41
			B20400-1/4M-18-SS	EXT.ASB.BSPT.ST.STL.	104.03
			B20400-1/4M-36-IENP	EXT.ASB BSPT IENP	88.29
			B20400-1/4M-36-SS	EXT.ASB.BSPT.ST.STL.	140.87
			B20400-1/8F-18-IENP	EXT. ASBLY,BSPT,IENP	68.41
			B20400-1/8F-18-SS	EXT.ASB.BSPT.ST.STL.	104.03
			B20400-1/8F-36-IENP	EXT. ASBLY,BSPT,IENP	88.29
			B20400-1/8F-36-SS	EXT.ASB.BSPT.ST.STL.	140.87
			B20900-1/4FXT	BALL VALVE BSPT.BR.	86.80
			B20900-1/4MXT	BALL VALVE BSPT.BR.	86.80
			B22470A-1/4	ISOLATOR ASB.,BSPT	128.17
			B22470A-1/8	ISOLATOR ASB.,BSPT	128.17

PART NO.	DESCRIPTION	U.S.DOLLARS	PART NO.	DESCRIPTION	U.S.DOLLARS
B22570-PP-15-1/4	TRIGGERJET W/EXT. PP	61.92	B3/8K-40	FLOODJET NOZ,BSPT,BR	19.76
B22570-PP-15-1/4-X18	TRIGGERJET W/X18BSPT	65.88	B3/8K-45	FLOODJET NOZ,BSPT,BR	19.76
B22570-PP-24-1/4	TRIGGERJET W/EXT. PP	72.14	B3/8K-SS30	FLOODJET NOZ,BSPT,SS	38.59
B22570-PP-24-1/4-X18	TRIGGERJET W/X18BSPT	75.94	B3/8K-SS35	FLOODJET NOZ,BSPT,SS	38.59
B22650-PP-1/4	TRIGGERJET POLYPRO.	41.80	B3/8K-SS40	FLOODJET NOZ,BSPT,SS	38.59
B22669-1/4-PPB	TEEJET ADAPT.POLYPRO	2.66	B3/8K-SS45	FLOODJET NOZ,BSPT,SS	38.59
B22670-PP-15-1/4	TRIGGERJET SPRAY GUN	65.88	B30L-1/4-VI	GUNJET VITON BSPT	103.12
B22670-PP-24-1/4	TRIGGERJET SPRAY GUN	75.94	B344BE-23-C	SHUTOFF VALV 3/4BSPT	461.07
B22674-1/4-NYB	45 DEG.QT ADAP.BSPT.	4.14	B344BE-23-C03	SHUTOFF VALV 3/4BSPT	461.07
B23120-1/2-PP	PRES.REL.VLV.BSPT.PP	51.91	B344BE-23-C15	SHUTOFF VALV 3/4BSPT	475.41
B23120-1/2-PP-60	PRES.RELIEF VLV BSPT	51.91	B344BE-23-C60	SHUTOFF VALV 3/4BSPT	514.11
B23120-1/2-PP-60-VI	BSPT PRES.RELIEF VALVE PP	78.38	B344BE-23-D	SHUTOFF VALV 3/4BSPT	461.07
B23120-3/4-PP	PRES.REL.VLV.BSPT.PP	51.91	B344BE-23S-C	SHUTOFF 3/4" SS BSPT	583.62
B23120-3/4-PP-60	PRES.RELIEF VLV BSPT	51.91	B344BE-23S-D	SHUTOFF 3/4" SS BSPT	583.62
B23120-3/4-PP-60-VI	PRES.RELIEF VALVE PP	78.38	B344BE-24-C	SHUTOFF VALVE 1 BSPT	461.07
B23120A-1/2-PP	PRES.REL.VLV.BSPT.PP	78.38	B344BE-24-C15	SHUTOFF VALVE 1 BSPT	475.41
B23120A-3/4-PP	PRES.REL.VLV.BSPT.PP	78.38	B344BE-24-C15OB	SHUTOFF VALVE 1 BSPT	497.37
B23220-1/4FX1/4F	PLUG VLV.ASB.BSPT.BR	32.84	B344BE-24-COB	SHUTOFF VALVE 1" BSPT	482.97
B23220-1/4FX1/4M	PLUG VLV.ASB.BSPT.BR	32.84	B344BE-24-D	SHUTOFF VALVE 1 BSPT	461.07
B23220-1/4FXT	PLUG VLV.ASB.BSPT.BR	32.84	B344BE-24S-C15	SHUTOFF VALVE SS1 BSPT	597.99
B23220-1/4MX1/4F	PLUG VLV.ASB.BSPT.BR	32.84	B344BE-24S-COB	SHUTOFF VALVE SS 1 BSPT	605.62
B23220-1/4MXT	PLUG VLV.ASB.BSPT.BR	32.84	B344BE-24S-CSB	SHUTOFF VALVE SS 1 BSPT	605.62
B23220-1/8FX1/8F	PLUG VLV.ASB.BSPT.BR	32.84	B344BE-24S-D	SHUTOFF VALVE SS 1 BSPT	583.62
B23240-3-316SS-5.7-316S	KEG WASH,NOZ.BSPT	977.93	B344BE-33-C	SHUTOFF/BYPAS 3/4BSPT	564.25
B23240-3-316SS-7-316SS	KEG WASHING NZ.316SS	1017.19	B344BE-33-C15	SHUTOFF/BYPASS 3/4 BSPT	578.60
B23520-1/2-PP	THROTTLING VLV.BSPT.	44.98	B344BE-33-C60	SHUTOFF/BYPAS 3/4BSPT	617.32
B23520-3/4-PP	THROTTLING VLV.BSPT.	44.98	B344BE-33-D	SHUTOFF/BYPASS 3/4 BSPT	564.25
B23624-30L-1/4	GUNJET SPRAY GUN	226.69	B344BE-34-C	SHUTOFF/BYPAS 1"BSPT	564.25
B23624L-30L-1/4	GUNJET SPRAY GUN	226.69	B344BE-34-C60	SHUTOFF/BYPASS 1 BSPT	617.32
B23830-1/4F	DOUBLE ROLLOVER VLV.	45.10	B344BE-34-CN15	SHUTOFF/BYPASS 1 BSPT N	578.60
B23830-1/4M	DOUBLE ROLLOVER VLV.	45.10	B344BE-34-D	SHUTOFF/BYPASS 1 BSPT	564.25
B23831-1/4F	SINGLE ROLLOVER VLV.	40.80	B344BE-34S-C	SHUTOFF/BYPAS SS1BSPT	686.89
B23831-1/4M	SINGLE ROLLOVER VLV.	40.80	B344BE-34S-CA	SHUTOFF/BYPAS SS1BSPT	697.88
B24216A-1-AC	NZL BODY W/AIR CHEM	71.26	B344BE-34S-D	SHUTOFF/BYPAS SS1BSPT	686.89
B24216A-1/2-AC	NZL BODY W/AIR CHEM	71.26	B344BEC-23-C	SHUTOFF VALV 3/4BSPT	461.07
B24216A-1/2M-AC	NZL BODY W/AIR CHEM	71.26	B344BEC-23-C15	SHUTOFF VALV 3/4BSPT	475.41
B24216A-1/2X7-AC	NZL BODY W/AIR CHEM	71.26	B344BEC-23-C60	SHUTOFF VALV 3/4BSPT	514.11
B24216A-20MM-AC	NZL BODY W/AIR CHEM	71.26	B344BEC-23-C60-R6	B344BEC 3/4 R6 CB MOTOR	514.11
B24216A-20MMX7-AC	NZL BODY W/AIR CHEM	71.26	B344BEC-23-CPK	SHUTOFF VALV 3/4BSPT	483.07
B24216A-3/4-AC	NZL BODY W/AIR CHEM	71.26	B344BEC-23-CQB	SHUTOFF VALVE 3/4" BSPT	482.97
B25660-0	GUNJET L/NOZ.BSPT	129.38	B344BEC-23-D	SHUTOFF VALV 3/4BSPT	461.07
B25660-1.5	GUNJET SPRAY GUN	147.72	B344BEC-23-DN	SHUTOFF VALV 3/4BSPT N	461.07
B25660-3.0	GUNJET SPRAY GUN	147.72	B344BEC-23-P	SHUTOFF VALVE 3/4" BSPT LESS CABLE	439.66
B25660-4.0	GUNJET SPRAY GUN	147.72	B344BEC-23S-C	SHUTOFF 3/4" SS BSPT	583.62
B25990-3/4-NYB	SWIVEL ASB NYLON	19.94	B344BEC-23S-C15	SHUTOFF 3/4" SS BSPT	597.99
B27500E-3/4-18-TEF	TANK WASH NOZ.TEFLON	438.22	B344BEC-23S-CN15	SHUTOFF 3/4" SS BSPT	597.99
B3/4K-100	FLOODJET NOZ,BSPT,BR	45.55	B344BEC-23S-D	SHUTOFF 3/4" SS BSPT	583.62
B3/4K-110	FLOODJET NOZ,BSPT,BR	45.55	B344BEC-24-C	SHUTOFF VALVE 1 BSPT	461.07
B3/4K-120	FLOODJET NOZ,BSPT,BR	45.55	B344BEC-24-C15	SHUTOFF VALVE 1 BSPT	475.41
B3/4K-140	FLOODJET NOZ,BSPT,BR	45.55	B344BEC-24-C15OB	SHUTOFF VALVE 1 BSPT	497.37
B3/4K-180	FLOODJET NOZ.BSPT.BR	84.00	B344BEC-24-C60	BSPT SHUTOFF VALVE 1"	514.11
B3/4K-210	FLOODJET NOZ.BSPT.BR	84.00	B344BEC-24-CJ	BSPT SHUTOFF VALVE 1"	472.01
B3/4K-90	FLOODJET NOZ,BSPT,BR	45.55	B344BEC-24-CN	SHUTOFF VALVE 1 BSPT N	461.07
B3/4K-SS100	FLOODJET NOZ.BSPT.SS	63.58	B344BEC-24-CN15	SHUTOFF VALVE 1 BSPT N	475.41
B3/4K-SS110	FLOODJET NOZ.BSPT.SS	63.58	B344BEC-24-CN15RB	SHUTOFF VALVE 1 BSPT N	497.37
B3/4K-SS120	FLOODJET NOZ.BSPT.SS	63.58	B344BEC-24-CPK	SHUTOFF VALVE 1 BSPT	482.97
B3/4K-SS210	FLOODJET NOZ.BSPT.SS	114.36	B344BEC-24-CVX	SHUTOFF VALVE 1 BSPT	482.97
B3/4K-SS90	FLOODJET NOZ.BSPT.SS	63.58	B344BEC-24-D	SHUTOFF VALVE 1 BSPT	461.07
B3/4KLC-108	FIELDJET NOZ.BSPT.BR	88.27	B344BEC-24-DN	SHUTOFF VALV 1BSPT N	461.07
B3/4KLC-50	FIELDJET NOZ,BR BSPT	88.27	B344BEC-24CN15	SHUTOFF NEG VLV 1"	475.41
B3/4KLC-72	FIELDJET.NZ.BSPT.BR.	88.27	B344BEC-24S-C	SHUTOFF VALV SS1BSPT	583.62
B3/4KLC-SS50	FIELDJET NOZ BSPT SS	129.71	B344BEC-24S-C03	SHUTOFF VALV SS1BSPT	583.62
B3/8K-30	FLOODJET NOZ,BSPT,BR	19.76	B344BEC-24S-C15	SHUTOFF VALV SS1BSPT	597.99
B3/8K-35	FLOODJET NOZ,BSPT,BR	19.76			

PART NO.	DESCRIPTION	U.S.DOLLARS	PART NO.	DESCRIPTION	U.S.DOLLARS
B344BEC-245-C15TU	SHUTOFF VALV SS1BSPT	619.99	B344BPR-34-01C15TU	1RPM 36SEC 1 BSPT	510.23
B344BEC-245-C60	SHUTOFF VALV SS1BSPT	636.69	B344BPR-34-01D	1RPM 36SEC 1 BSPT	455.20
B344BEC-245-CPK	SHUTOFF VALV SS1BSPT	605.62	B344BPR-34-03C	3RPM 12SEC 1 BSPT	455.20
B344BEC-245-D	SHUTOFF VALV SS1BSPT	583.62	B344BPR-34-03D	3RPM 12SEC 1 BSPT	455.20
B344BEC-33-C	SHUTOF/BYPAS 3/4BSPT	564.25	B344BPR-34-06C	6RPM 6SEC 1 BSPT	455.20
B344BEC-33-C15	SHUTOF/BYPAS 3/4BSPT	578.60	B344BPR-34-06C03	6RPM 6SEC 1 BSPT	455.20
B344BEC-33-C60	SHUTOF/BYPAS 3/4BSPT	617.32	B344BR-23-03C	3RPM 6SEC R REG BSPT	473.85
B344BEC-33-CN	SHUTOFF/BYPASS NEG 3/4 BSPT	564.25	B344BR-23-03C15	3RPM 6SEC R REG BSPT	488.21
B344BEC-33-D	SHUTOF/BYPAS 3/4BSPT	564.25	B344BR-23-03D	3RPM 6SEC R/4 BSPT	473.85
B344BEC-33S-C	SHUTOF/BYPAS SS 3/4 BSPT	686.89	B344BR-23-06C	6RPM 3SEC R REG BSPT	473.85
B344BEC-33S-C03	SHUTOF/BYPAS SS 3/4 BSPT	686.89	B344BR-23S-03C60	3RPM 6SEC SS 3/4 BSPT	621.45
B344BEC-33S-CN15	SHUTOF/BYPAS SS 3/4 NEG BSPT	701.26	B344BR-23S-03D	3RPM 6SEC SS 3/4 BSPT	568.41
B344BEC-33S-Q	SHUTOFF/BYPASS SS ¾ BSPT	686.89	B344BR-24-01C	1RPM 18SEC 1 BSPT	473.85
B344BEC-34-C	SHUTOFF/BYPASS 1BSPT	564.25	B344BR-24-01D	1RPM 18SEC 1 BSPT	473.85
B344BEC-34-C03	SHUTOFF/BYPASS 1BSPT	564.25	B344BR-24-03C	3RPM 6SEC 1 BSPT	473.85
B344BEC-34-C15	SHUTOFF/BYPASS 1BSPT	578.60	B344BR-24-03CA	3RPM 6SEC R REG	484.80
B344BEC-34-C60	SHUTOFF/BYPASS 1BSPT	617.32	B344BR-24-03D	3RPM 6SEC 1 BSPT	473.85
B344BEC-34-C60J	SHUTOFF/BYPASS 1BSPT	623.54	B344BR-24-06C	6RPM 3SEC R REG BSPT	473.85
B344BEC-34-C60TU	SHUTOFF/BYPASS 1BSPT	639.25	B344BR-24-06D	6RPM 3SEC R REG BSPT	473.85
B344BEC-34-CN	SHUTOFF/BYPASS 1BSPT	564.25	B344BR-24S-01C	1RPM 18SEC SS 1BSPT	568.41
B344BEC-34-CN15	SHUTOFF/BYPASS 1BSPT	578.60	B344BR-24S-01C15	1RPM 18SEC SS 1BSPT	582.79
B344BEC-34-CN15RB	SHUTOFF/BYPASS 1BSPT	600.58	B344BR-24S-01D	1RPM 18SEC SS 1BSPT	568.41
B344BEC-34-D	SHUTOFF/BYPASS 1BSPT	564.25	B344BR-24S-03C15	3RPM 6SEC SS 1BSPT	582.79
B344BEC-34-DN	SHUTOFF/BYPASS 1BSPT	564.25	B344BR-24S-06C	6RPM 3SEC SS 1BSPT	568.41
B344BEC-34S-C	SHUTOF/BYPAS SS1BSPT	686.89	B344BR-33-01C	3RPM 6SEC 3/4 BSPT	577.63
B344BEC-34S-C15	SHUTOF/BYPAS SS1BSPT	701.26	B344BR-33-03C15	3RPM 6SEC R REG	592.04
B344BEC-34S-C15TU	SHUTOF/BYPAS SS1BSPT	723.21	B344BR-33-06C	6RPM 3SEC R REG BSPT	577.63
B344BEC-34S-D	SHUTOF/BYPAS SS1BSPT	686.89	B344BR-33S-03C03	3 RPM 3SEC R REG SS BSPT	672.19
B344BEC-34S-DN	SHUTOFF VALVE 1" SS	686.89	B344BR-34-01D	Desc: 1RPM 18SEC R REG	564.59
B344BLPR-23S-03C	LF 3RPM 12SEC 3/4 BSPT	568.41	B344BR-34-03C	3RPM 6SEC 1 BSPT	577.63
B344BLPR-33S-03C	LF 3RPM 12SEC 3/4 BSPT	568.41	B344BR-34-03CEC	3RPM 6SEC 1 BSPT	599.53
B344BLPR-34S-03D	LF 3RPM 12SEC 1 BSPT	568.41	B344BR-34-03D	3RPM 6SEC R REG	564.59
B344BPR-23-01C	1RPM 36SEC 3/4 BSPT	455.20	B344BR-34-06C	6RPM 3SEC R REG BSPT	577.63
B344BPR-23-01C15	1RPM 36SEC 3/4 BSPT	478.51	B344BR-34S-01-D	1RPM 18 SEC SS 1BSPT	672.19
B344BPR-23-01C60	1RPM 36SEC 3/4 BSPT	508.22	B344BR-34S-01C	1RPM 18 SEC SS 1BSPT	672.19
B344BPR-23-01CCS	1RPM 36SEC 3/4 BSPT	477.15	B344BR-34S-03C	3RPM 6SEC SS 1BSPT	672.19
B344BPR-23-01CTU	1RPM 36SEC PR REG BSPT	477.15	B344BRL-23-01C	1RPM 18SEC 3/4 BSPT	473.85
B344BPR-23-01D	1RPM 36SEC 3/4 BSPT	455.20	B344BRL-23-01C15	1RPM 18SEC 3/4 BSPT	488.21
B344BPR-23-03C	3RPM 12SEC 3/4 BSPT	455.20	B344BRL-23-01C60	1RPM 18SEC 3/4 BSPT	526.86
B344BPR-23-03C15EC	B344BPR-23-03C BALL VALVE ASB	497.95	B344BRL-23-01D	1RPM 18SEC RL REG BSPT	473.85
B344BPR-23-03CIG	3RPM 12SEC PR REG	477.15	B344BRL-23-03C	3RPM 6SEC 3/4 BSPT	473.85
B344BPR-23-03D	3RPM 12SEC 3/4 BSPT	455.20	B344BRL-23-03C15	3 RMP 6 SEC ¾ BSPT	488.21
B344BPR-23-06C	6RPM 6SEC 3/4 BSPT	455.20	B344BRL-23-03C60	3RPM 6SEC 3/4 BSPT	526.86
B344BPR-23-06D	6RPM 6SEC 3/4 BSPT	455.20	B344BRL-23-03CCC	3RPM 6SEC 3/4 BSPT	495.81
B344BPR-24-01C	1RPM 36SEC 1 BSPT	455.20	B344BRL-23-03CCS	3RPM 6SEC 3/4 BSPT	495.81
B344BPR-24-01C15TU	1RPM 36SEC 1 BSPT	500.41	B344BRL-23-03D	3RPM 6SEC RL BSPT	473.85
B344BPR-24-01CTU	1RPM 36SEC 1 BSPT	477.15	B344BRL-23-06C	344BRL assembly 2-way 3/4	473.85
B344BPR-24-01D	1RPM 36SEC 1 BSPT	455.20	B344BRL-23S-01C	1RPM 18SEC 3/4 BSPT	568.41
B344BPR-24-03C	3RPM 12SEC 1 BSPT	455.20	B344BRL-24-01C	1RPM 18SEC 1 BSPT	473.85
B344BPR-24-03C15	3RPM 12SEC 1 BSPT	478.51	B344BRL-24-01C15	1RPM 18SEC 1 BSPT	488.21
B344BPR-24-03C15TU	3RPM 12SEC 1 BSPT	500.41	B344BRL-24-01C15HC	1RPM 18SEC 1 BSPT	510.23
B344BPR-24-03D	3RPM 12SEC 1 BSPT	455.20	B344BRL-24-01C15RB	1RPM 18SEC 1 BSPT	510.23
B344BPR-24-06C	6RPM 3SEC 1 BSPT	455.20	B344BRL-24-01CHC	1RPM 18SEC 1 BSPT	495.81
B344BPR-24-06D	6RPM 6SEC 1 BSPT	455.20	B344BRL-24-01D	1RPM 18SEC 1 BSPT	473.85
B344BPR-33-01C	1RPM 36SEC 3/4 BSPT	455.20	B344BRL-24-03C	3RPM 6SEC 1 BSPT	473.85
B344BPR-33-01C15	1RPM 36SEC 3/4 BSPT	469.58	B344BRL-24-03C15	3RPM 6SEC 1 BSPT	488.21
B344BPR-33-01D	1RPM 36SEC PR REG	455.20	B344BRL-24-03C15TU	3RPM 6SEC 1 BSPT	510.23
B344BPR-33-03C	3RPM 12SEC 3/4 BSPT	455.20	B344BRL-24-03C60	3RPM 6SEC 1 BSPT	526.86
B344BPR-33-03C15	6RPM 6SEC 3/4 BSPT	469.60	B344BRL-24-03C60GC	3RPM 6SEC 1 BSPT	548.88
B344BPR-33-03D	3RPM 12SEC 3/4 BSPT	455.20	B344BRL-24-03C60GS	3RPM 6SEC 1 BSPT	548.88
B344BPR-33-06C	6RPM 6SEC 3/4 BSPT	455.20	B344BRL-24-03C60IG	3RPM 6SEC 1 BSPT	548.88
B344BPR-33-06C15	6RPM 3SEC 3/4 BSPT	469.60	B344BRL-24-03CCC	3RPM 6SEC 1 BSPT	495.81
B344BPR-34-01C	1RPM 36SEC 1 BSPT	455.20	B344BRL-24-03CCS	3RPM 6SEC 1 BSPT	495.81
B344BPR-34-01C15AB	1RPM 36SEC PR REG BSPT	491.55	B344BRL-24-03CDC	3RPM 6SEC RL REG	495.81

PART NO.	DESCRIPTION	U.S.DOLLARS	PART NO.	DESCRIPTION	U.S.DOLLARS
B344BRL-24-03D	3RPM 6SEC 1 BSPT	473.85	B346BPR-25-06C03	6RPM 6SEC REG 1-1/4BSPT	991.88
B344BRL-24-06C	6RPM 3SEC 1 BSPT	473.85	B346BPR-25-06C60	6RPM 6SEC REG B1-1/4	1044.91
B344BRL-24-06D	6RPM 3SEC 1 BSPT	473.85	B346BPR-25-06D	6RPM 6SEC REG 1-1/4BSPT	991.88
B344BRL-24S-01C	1RPM 18SEC 1 BSPT	568.41	B346BPR-26-03C	3RPM 12SEC REG 1-1/2	991.88
B344BRL-24S-01D	1RPM 18SEC SS 1BSPT	568.41	B346BPR-26-03D	3RPM 6SEC REG 1-1/2	991.88
B344BRL-24S-03C	3RPM 6SEC SS 1 BSPT	568.41	B346BPR-26-06D	6RPM 6SEC REG 1-1/2	991.88
B344BRL-24S-03C15	3RPM 6SEC SS 1 BSPT	582.79	B346BPR-35-01C	1RPM 36SEC REG 1-1/4	991.88
B344BRL-24S-03C60	3RPM 6SEC SS 1BSPT	621.46	B346BPR-35-03C	3RPM 12SEC REG 1-1/4 BSPT	991.88
B344BRL-24S-03CCS	3RPM 6SEC SS 1BSPT	590.40	B346BPR-35-03D	3RPM 12SEC REG 1-1/2	991.88
B344BRL-24S-03CFS	3RPM 6SEC SS 1BSPT	590.40	B346BPR-35-06C	6RPM 3SEC REG 1-1/2	991.88
B344BRL-24S-03CGS	3RPM 6SEC SS 1BSPT	590.40	B346BPR-35-06CQA	6RPM 3 SEC REG 1-1/4 BSPT	1013.83
B344BRL-24S-03D	3RPM 6SEC SS 1BSPT	568.41	B346BPR-35-06D	6RPM 6SEC REG 1-1/4 BSPT	991.88
B344BRL-24S-06C	6RPM 3SEC SS 1BSPT	568.41	B346BPR-36-03D	3RPM 12SEC 11/2 BSPT	991.88
B344BRL-24S-06D	6RPM 3SEC 1BSPT	568.41	B346BPR-36-06CVB	6RPM 3SEC 11/2 BSPT	1013.83
B344BRL-B4-03D	3RPM, 6SEC, RL BSPT	493.16	B346BPR-36-06D	6RPM 6SEC 1-1/2 BSPT	991.88
B346BE-25-C15	SHUTOFF VALVE 1-1/4	874.30	B346BR-25-01C	1RPM 18SEC REG 1-1/4	991.88
B346BE-25-C60	SHUTOFF VALVE 1-1/4	912.97	B346BR-25-01C60	1RPM 18SEC REG 1-1/4	1044.91
B346BE-26-C60	SHUTOFF VALVE 1-1/4	912.97	B346BR-25-01D	1RPM 18SEC REG 1-1/4	991.88
B346BE-26-D	SHUTOFF VALVE 1-1/2	859.91	B346BR-25-03C	3RPM 6SEC REG 1-1/4	991.88
B346BE-26S-C	SHUTOFF VALVE SS 1-1/2	1019.27	B346BR-25-03CCS	3RPM 6SEC REG 1-1/4	1013.83
B346BE-35-C15	SHUTOFF/BYPASS 1-1/4	874.30	B346BR-25-03CFS	3RPM 6SEC REG 1-1/4	984.29
B346BE-35-C60	SHUTOFF/BYPASS 1-1/4	912.97	B346BR-25-03D	3RPM 6SEC REG 1-1/4	991.88
B346BE-35-D	SHUTOFF/BYPASS 1-1/4	859.91	B346BR-25-06C15	6RPM 3SEC REG 1-1/4	1006.26
B346BE-35S-C15	SHUTOFF/BYPASS 1-1/4	1030.60	B346BR-25-06D	6RPM 3SEC REG 1-1/4	991.88
B346BE-36-C	SHUTOFF/BYPASS 1-1/2	859.91	B346BR-25-01C15	1RPM 18SEC REG 1-1/4	1162.54
B346BE-36-D	SHUTOFF/BYPASS 1-1/2	859.91	B346BR-25S-03C	3RPM 6SEC REG 1-1/4	1148.16
B346BEC-25-C	SHUTOFF VALVE 1-1/4	859.91	B346BR-25S-03CFS	3 RPM 6SEC REG 1-1/4	1152.89
B346BEC-25-C60	SHUTOFF VALVE 1-1/4 BSPT	912.97	B346BR-26-01C	1RPM 18SEC REG 1-1/2	991.88
B346BEC-25-COG	SHUTOFF VALVE 1-1/4	881.82	B346BR-26-01C15	1RPM 18SEC REG 1-1/2	1006.25
B346BEC-25-CPG	SHUTOFF VALVE 1-1/4	881.82	B346BR-26-01C15HC	1RPM 18SEC 1-1/2BSPT	1028.17
B346BEC-25-CPK	SHUTOFF VALVE 1-1/4	881.84	B346BR-26-01C15RB	1RPM 18SEC REG 1-1/4	1028.17
B346BEC-25-D	SHUTOFF VALVE 1-1/4	859.91	B346BR-26-01D	1RPM 18SEC REG 1-1/2	991.88
B346BEC-25S-C15	SHUTOFF VALV SS1-1/4	1030.59	B346BR-26-03C	3RPM 6SEC 1-1/2 BSPT	991.88
B346BEC-25S-C60	SHUTOFF VALVE 1-1/4SS	1069.27	B346BR-26-03C15	3RPM 6SEC REG 1-1/2	1006.26
B346BEC-25S-D	SHUTOFF VALVE SS 1-1/4	1016.22	B346BR-26-03C60	3RPM 6SEC REG 1-1/2	1044.90
B346BEC-26-C	SHUTOFF VALVE 1-1/2	859.91	B346BR-26-03D	3RPM 6SEC REG 1-1/2	991.88
B346BEC-26-C15	SHUTOFF VALVE 1-1/2	874.30	B346BR-26-06C	6RPM 3SEC REG 1-1/2	991.88
B346BEC-26-CPK	SHUTOFF VALVE 1-1/2	881.82	B346BR-26-06D	6RPM 3SEC REG 1-1/2	991.88
B346BEC-26-D	SHUTOFF VALVE 1-1/2	859.91	B346BR-26S-01C15IG	1RPM 18SEC REG 1-1/2	1184.50
B346BEC-26S-C	SHUTOFF VALVE 1-1/2	1019.27	B346BR-26S-01C60	1RPM 18SEC REG 1-1/2	1201.18
B346BEC-26S-C03	SHUTOFF VALVE 1-1/2 SS	1016.22	B346BR-26S-01D	1RPM 18SEC REG 1-1/2	1148.16
B346BEC-26S-C15	SHUTOFF 1-1/2 SS	1030.61	B346BR-26S-03C	3RPM 6SEC REG 1-1/2 SS	1148.16
B346BEC-26S-CPK	SHUTOFF 1-1/2 SS	1038.21	B346BR-26S-03C03	3RPM 6SEC REG 1-1/2 SS	1148.16
B346BEC-26S-D	SHUTOFF VALV SS1-1/2	1016.22	B346BR-26S-03C15	3RPM 6SEC REG	1162.54
B346BEC-35-C	SHUTOFF/BYPASS 1-1/4	859.91	B346BR-26S-03C60	3RPM 6SEC REG 1-1/2	1201.18
B346BEC-35-C15	SHUTOFF/BYPASS 1-1/4	874.32	B346BR-26S-03D	3RPM 6SEC REG 1-1/2	1148.16
B346BEC-35-C60	SHUTOFF/BYPASS 1-1/4	912.97	B346BR-26S-06C	6RPM 3SEC SS R REG	1148.16
B346BEC-35-C60TU	SHUTOFF/BYPASS 1-1/4	934.87	B346BR-26S-06D	6RPM 3SEC REG 1-1/2	1148.16
B346BEC-35-D	SHUTOFF/BYPASS 1-1/4	859.91	B346BR-35-01D	1RPM 18SEC REG 1-1/4	991.88
B346BEC-36-C	SHUTOFF/BYPASS BSPT	859.91	B346BR-35-03C	3RPM 6SEC REG 1-1/4 BSPT	991.88
B346BEC-36-C15	SHUTOFF/BYPASS 1-1/2	874.32	B346BR-35-03C15	3RPM 6SEC REG 1-1/4 BSPT	1006.26
B346BEC-36-C15TU	SHUTOFF/BYPASS 1-1/2	896.25	B346BR-35-03CEC	3RPM 6SEC REG 1-1/4 BSPT	1013.83
B346BEC-36-C60	SHUTOFF/BYPASS 1-1/2	912.97	B346BR-35-03CFC	3RPM 6SEC REG 1-1/4	1013.83
B346BEC-36-CK	SHUTOFF/BYPASS 1-1/2	870.97	B346BR-35-03D	3RPM 6SEC REG 1-1/4 BSPT	991.88
B346BEC-36-CN	SHUTOFF/BYPASS 1-1/2	859.91	B346BR-36-01C15	1RPM 18SEC REG 1-1/2 BSPT	1006.26
B346BEC-36-CN15	SHUTOFF/BYPASS 1-1/2	874.32	B346BR-36-03C	3RPM 6SEC REG 1-1/2 BSPT	991.88
B346BEC-36-CN15RB	SHUTOFF/BYPASS 1-1/2	896.25	B346CPR-36-03Q	Q CAN BUS BALL VALVE	1211.66
B346BEC-36-CRC	SHUTOFF/BYPASS 1-1/2	881.87	B37270-122-1/2-PP-100	STRAINER BSPT PP	105.96
B346BEC-36-D	SHUTOFF/BYPASS 1-1/2	859.91	B37270-122-1/2-PP-200	STRAINER POLYPRO	105.96
B346BEC-36-DN	SHUTOFF/BYPASS 1-1/2	859.91	B37270-122-1/2-PP-50	STRAINER POLYPRO	105.96
B346BPR-25-01C60	1RPM 36SEC REG 1-1/4	1044.91	B37270-122-3/4-PP-100	STRAINER POLYPRO	105.96
B346BPR-25-01D	1RPM 36SEC REG 1-1/4	991.88	B37270-122-3/4-PP-50	STRAINER POLYPRO	105.96
B346BPR-25-03C60	3RPM 12SEC 1-1/4BSPT	1044.89	B37555-3/4-PP	THROTTLING VLV,BSPT	36.68
B346BPR-25-03D	3RPM 12SEC REG 1-1/4 BSPT	991.88	B37740-PP-1/4	TRIGGERJET, BSPT	39.43

PART NO.	DESCRIPTION	U.S.DOLLARS	PART NO.	DESCRIPTION	U.S.DOLLARS
B38348-344EC-2-1	BSPT BALL VALVE	795.32	B454BEC-3FB3-D	450 FLOWBACK MNFD	2153.29
B38348-344EC-2-3/4	BSPT BALL VALVE	795.32	B455BE-23-D	450 MANIFOLD	2437.90
B440BEC-3-C	REPLACEMENT VLVE ASB	480.73	B455BEC-23-C	450 MANIFOLD	2437.90
B440BRL-4-03C60IN	3RPM 6SEC RL REG MAN	568.51	B455BEC-23-D	450 MANIFOLD	2437.90
B441BEC-44T4T-C	440 MANIFOLD	575.44	B455BEC-23S-C	450 MANIFOLD	3094.67
B441BEC-454TB-D	B441BEC-454TB-D BALL VALVE ASB	698.06	B455BEC-23S-D	455 MANIFOLD	3094.67
B442BEC-34HB-D	440 MANIFOLD	1112.67	B455BEC-24-C	450 MANIFOLD	2437.90
B443BEC-31T4T-D	440 MANIFOLD	1656.90	B455BEC-24-D	450 MANIFOLD	2437.90
B443BEC-34H4T-C	440 MANIFOLD	1656.90	B455BEC-24S-C	450 MANIFOLD	3094.67
B443BEC-34T1T-C15	440 MANIFOLD	1700.02	B455BEC-24S-C15	450 MANIFOLD	3166.58
B443BEC-34T1T-C60	440 MANIFOLD	1816.02	B455BEC-24S-C15TU	450 MANIFOLD	3282.08
B443BEC-34T1T-C60TU	440 MANIFOLD	1881.85	B455BEC-24S-D	450 MANIFOLD	3094.67
B443BEC-34T1T-D	440 MANIFOLD	1656.90	B455BEC-2N4-D	450N MANIFOLD	2437.90
B443BEC-34T4T-C	440 MANIFOLD	1656.90	B455BEC-3FB3-C15VX	450 FLOWBACK MNFD	2874.47
B443BEC-34TB-C60	440 MANIFOLD	1816.02	B455BEC-3FB3-C60	450 FLOWBACK MNFD	2946.87
B443BEC-34TB-D	440 MANIFOLD	1656.90	B455BEC-3FB3-CVX	450 FLOWBACK MNFD	2802.56
B443BEC-44T4T-C	440 BALL VALVE	1656.90	B455BEC-3FB3-D	450 FLOWBACK MNFD	2681.70
B443BEC-44T4T-D	440 MANIFOLD	1656.90	B455BEC-3FB3S-D	450 FLOWBACK MNFLD	3404.15
B443BEC-454TB-D	440 MANIFOLD SS	2024.78	B455BEC-3FB4S-C15TU	450 FLOWBACK MNFD BSPT	3586.06
B443BEC-F4TB-D	440 MANIFOLD FLNG/1"	1656.90	B455BEC-3FB4S-D	450 MANIFOLD	3404.15
B444BEC-34H4T-C15	440 MANIFOLD	2255.24	B457BEC-24-C	450 MANIFOLD	3376.65
B444BEC-34T1T-C	440 MANIFOLD	2197.84	B457BEC-24S-D	450 MANIFOLD	4758.74
B444BEC-34T1T-C15	440 MANIFOLD	2255.24	B459BEC-3FB3-D	450 FLOWBACK MNFD	4815.56
B444BEC-34T1T-C60	440 MANIFOLD	2409.97	B461BE-24-D	460 MANIFOLD DIN	565.63
B444BEC-34T1T-C60TU	440 MANIFOLD	2497.95	B461BEC-23-C	460 MANIFOLD	565.63
B444BEC-34T1T-D	440 MANIFOLD	2197.84	B461BEC-23-C03	460 MANIFOLD	565.63
B444BEC-34TB-C60	440 MANIFOLD	2409.97	B461BEC-23-D	460 MANIFOLD	565.63
B444BEC-44T4T-C	440 BALL VALVE	2197.84	B461BEC-24-C	460 MANIFOLD	565.63
B444BEC-454T4T-CN15AB	440 MANIFOLD SS BSPT	2833.59	B461BEC-24-COP	460 MANIFOLD 1" BSPT	587.52
B444BEC-Q4H1T-D	440 MANIFOLD	2197.84	B461BEC-24-D	460 MANIFOLD DIN	565.63
B445BEC-34HB-D	440 MANIFOLD	2735.76	B461BEC-3C3-C	460 MANIFOLD	810.06
B445BEC-34T1T-C	440 MANIFOLD	2735.76	B461BEC-3C3-D	460 MANIFOLD	810.06
B445BEC-34T1T-C15	440 MANIFOLD	2807.64	B461BEC-3E3-C15	460 SHUTOFF/BYPASS	931.43
B445BEC-34T1T-C60	440 MANIFOLD BSPT	3000.94	B461BEC-3FB3-D	460 FLOWBACK	976.61
B445BEC-34T1T-C60TU	440 MANIFOLD	3110.88	B462BE-23-C	460 MANIFOLD	1094.28
B445BEC-34T1T-D	440 MANIFOLD BSPT	2735.76	B462BE-23-D	460 MANIFOLD	1156.22
B445BEC-44T1T-D	445 MANIFOLD	2735.76	B462BEC-23-C	460 MANIFOLD BSPT	1156.22
B445BEC-4S4HB-C	445 MANIFOLD ASBLY	3348.90	B462BEC-23-D	460 MANIFOLD BSPT	1156.22
B445BEC-F4TB-D	440 MANIFOLD	2735.76	B462BEC-24-C	460 MANIFOLD BSPT	1156.22
B445BEC-Q4H1T-D	440 MANIFOLD	2735.76	B462BEC-24-D	460 MANIFOLD 1" BSPT	1156.22
B451BEC-23-C	450 MANIFOLD	472.72	B462BEC-3C4-C	SHUTOFF/BYPASS 1 BSPT	1652.21
B451BEC-23S-C	450 MANIFOLD	595.30	B462BEC-3EQ-C03OB	BALL VALVE ASSEMBLY	1910.08
B451BEC-24-C	450 MANIFOLD	471.57	B462BEC-3FB3-D	460 FLOW BACK	1985.36
B451BEC-24-D	450 MANIFOLD	472.72	B463BEC-23-C	460 MANIFOLD	1746.84
B451BEC-24S-C	450 MANIFOLD	595.30	B463BEC-23-C15	460 MANIFOLD ¾" BSPT	1789.97
B451BEC-24S-C15	450 MANIFOLD	609.72	B463BEC-23-D	460 MANIFOLD	1746.84
B451BEC-24S-D	450 MANIFOLD	595.30	B463BEC-24-C	460 MANIFOLD 1" BSPT	1746.84
B451BEC-2N3-CQB	450N MANIFOLD	494.61	B463BEC-24-D	460 MANIFOLD 1" BSPT	1746.84
B451BEC-3FB3-D	450 FLOWBACK MNFLD	519.93	B463BEC-3C3-D	460 MANIFOLD	2494.34
B452BEC-24-CUX	452 MANIFOLD	1018.90	B463BEC-3C4-C	BYPASS.SHUTOFF VALVE	2494.34
B452BEC-2N3-CQB	450N MANIFOLD	1018.90	B463BEC-3C4-C15	SHUTOFF/BYPASS 1"	2564.19
B452BEC-3FB3-D	450 FLOWBACK MNFD	1072.47	B463BEC-3E3-C15	460 MANIFOLD	2858.46
B453BEC-23-C	450 MANIFOLD	1477.14	B463BEC-3FB3-D	460 FLOW BACK	2994.07
B453BEC-23S-C	450 MANIFOLD	1844.96	B464BE-24-D	460 MANIFOLD	2337.47
B453BEC-24-C	450 MANIFOLD	1477.14	B464BE-3C3-D	SHUT/BYPASS MANIFOLD	3203.05
B453BEC-24S-C	450 MANIFOLD	1844.96	B464BEC-23-D	460 MANIFOLD	2337.47
B453BEC-24S-D	450 MANIFOLD	1844.96	B464BEC-24-D	460 MANIFOLD	2337.55
B453BEC-3FB3-D	450 FLOWBACK MNFD	1624.83	B464BEC-3E3-C	460 MANIFOLD	3764.62
B454BE-2N3S-C	450 SS 1" BSPT NARROW	2469.82	B464BEC-3E3-CPB	460 MANIFOLD	3852.56
B454BEC-24-D	450 MANIFOLD	1957.58	B464BEC-3E4-C	460 MANIFOLD	3764.62
B454BEC-24S-C15TU	450 SS 1" BSPT	2615.15	B464BEC-3FB3-D	460 FLOW BACK	4002.81
B454BEC-2N3-C60	450 MANIFOLD	2169.73	B464BEC-3FB4-D	460 FLOWBACK MANIFLD	4002.81
B454BEC-3FB3-C60	450 FLOWBACK MNFD	2365.42	B46550-1/4-PP	EDUCTOR, PP, BSPT	64.68
			B465BEC-23-C	460 MANIFOLD	2928.10

PART NO.	DESCRIPTION	U.S.DOLLARS	PART NO.	DESCRIPTION	U.S.DOLLARS
B465BEC-23-C15	460 MANIFOLD	2942.47	B56602-11-265-C15	346B NORM OPEN 1-1/2	1030.58
B465BEC-23-D	465 MANIFOLD	2928.10	B56602-11-36-D	346B NORM OPEN 1-1/2	859.91
B465BEC-24-C	460 MANIFOLD BSPT	2928.10	B56603-2-11/2	2-WAY 346B BODY BSPT	623.96
B465BEC-24-CVX	460 MANIFOLD 1" BSPT	3037.86	B56603-2-11/2-SS	2-WAY 346B BODY BSPT	816.85
B465BEC-24-D	460 MANIFOLD	2928.10	B56603-2-11/4	2-WAY 346B BODY BSPT	623.96
B465BEC-24-DN	460 MANIFOLD N	2928.10	B56603-2-11/4-SS	2-WAY 346B BODY BSPT	816.85
B465BEC-3C4-C	460 MANIFOLD	4178.69	B56603-3-11/2	3-WAY 346B BODY BSPT	623.96
B465BEC-3C4-D	460 MANIFOLD	4178.69	B56603-3-11/2-0	SPECIAL SUB ASSEMBLY	582.40
B465BEC-3E3-C15	460 MANIFOLD	4785.51	B56603-3-11/4	3-WAY 346B BODY BSPT	623.96
B465BEC-3FB3-D	460 FLOW BACK	5012.36	B56603-3PR-11/2	RPL/ASB B346B36 L/MTR	617.78
B465BEC-3FB4-D	460 FLOWBACK MANIFLD	5012.36	B56607-2-1	441 SUB/ASB 1"BSPT	336.51
B466BEC-23-D	460 MANIFOLD	3518.78	B56607-2-1-SS	B440 SS SUB/ASB 1"	459.06
B466BEC-3C3-C	460 MANIFOLD	5020.83	B56607-2-3/4	B440 VLV SUB/ASB 3/4	336.51
B466BEC-3C4-C	460 MANIFOLD	5020.83	B56607-2RL-1	441RL SUB/ASB 1"BSPT	349.89
B466BEC-3C4-D	460 MANIFOLD	5020.83	B56609-2-1	B450 VLV SUB/ABB 1"	330.89
B466BEC-3FB3-D	460 FLOW BACK	5998.14	B56609-2-3/4	B450 VLV SUB/ASB 3/4	330.89
B4676-1/2	TEEJET ADAP.BSPT.BR.	12.99	B56609-2RL-1	2-WAY RL VALVE SUB ASSM	372.63
B4676-1/4	TEEJET ADAP.BSPT.BR.	4.24	B56610-11-54-C15TU	465BEC FOR AIRJET	3196.01
B4676-1/8	TEEJET ADAP.BSPT. BR	4.24	B56611-2-1	B460 VLV SUB/ASB 1"	395.97
B4676-3/8	TEEJET ADAP.BSPT.BR.	4.24	B56611-2-3/4	B460 VLV SUB/ASB 3/4	395.97
B4676-AL-1/8	TEEJET ADAP.BSPT.AL.	4.12	B56611-3FB-1	460 FLOWBACK	436.63
B4676-SS-1/4	TEEJET ADPT.BSPT.SS	14.26	B56611-3FB-3/4	460 FLOWBACK	436.63
B4676-SS-1/8	TEEJET ADAP.BSPT.SS	14.26	B56720-1-F	AIRCHEM ASSEM	55.10
B4676-SS-3/8	ADAPTER BSPT.ST.STL	23.09	B56720-1/8-B	AIR CHEMSAVER BSPT	55.10
B467BEC-23-D	460 MANIFOLD	4109.58	B56720-1/8-F	AIR CHEMSAVER BSPT	55.10
B4727	BSPT SURE GRIP HANDLE (M)	17.92	B58456-1	LQC X 1" BSPT F KIT	25.02
B5000-1/4T	TEEJET SW.ASB.BSPT.	26.57	B58456-1-1/2	LQC X1 1/2BSPT F KIT	25.02
B5082-1/4X1/4	SWIVEL CONN.BSPT.BR.	36.30	B58456-1-1/4	LQC X1 1/4BSPT F KIT	25.02
B55270-1/2-11-POM	TANK RINSING NOZZLE	124.66	B58456-1/4	LQC GUAGE P BSPT KIT	25.02
B55270-3/4-18-POM	TANK RINSING NOZZLE	124.66	B58456-3/4	LQC X3/4" BSPT F KIT	25.02
B5540-1/4TT	TEEJET SW.ASB.BSPT.	37.35	B6240-1/4TT	TEEJET SW.BDY BSPT	40.53
B56600-11-23-C	BALL VALVE ASSEMBLY	461.07	B62905C-5	JET AGITATOR,BR.BSPT	60.35
B56600-11-23S-C	344B NORM OPEN 3/4" BSPT	583.62	B6406	TEEJET ADPTER,BSPT	7.41
B56600-11-24-C	BALL VALVE ASSEMBLY	461.07	B6590	TRIGGER VALVE,BSPT	74.30
B56600-11-24S-D	344B NORM OPEN 1"	583.62	B6815-1/2-300	PRES. REL VALV BSPT	156.15
B56600-11-33-C	344 3WAY NORMAL OPEN	564.25	B6815-1/2-700	PRES.RELIEF VALVE,BR	156.15
B56600-11-33-D	344 3WAY NORMAL OPEN	564.25	B6815-1/2-HSS-700	PRES.RELIEF VALVE,BR	156.15
B56600-11-33S-C	344 3WAY NORMAL OPEN	686.86	B6815-3/4-300	PRES.REL.VLV.BSPT.BR	156.15
B56600-11-33S-C15	344 3WAY NORMAL OPEN	701.26	B6815-3/4-50	PRES.REL.VLV.BSPT.BR	156.15
B56600-11-34-C	BALL VALVE ASSEMBLY	564.25	B6815-3/4-700	PRES.REL.VLV.BSPT.BR	156.15
B56600-11-34-C60TU	344B NORM OPEN 1"	639.31	B7450-2T	TEEJT.SW.ASB.BSPT.BR	68.08
B56600-11-34-CN	344 3WAY NORMAL OPEN	564.25	B7521A-1/2X1/4	SPLIT-EYELET CONN.BR	13.36
B56600-11-34-CN15RB	344 3WAY NORMAL OPEN	600.62	B7521A-1/2X1/8	SPLIT-EYELET CONN.BR	13.36
B56600-11-34-D	344B NORM OPEN	564.25	B7521A-1X1/4	SPLIT-EYELET CONN.BR	13.36
B56600-14-24-01D	1RPM 18SEC RL REG 90	474.42	B7521A-1X1/8	SPLIT-EYELET CONN.BR	13.36
B56600-14-24-03D	3RPM 6SEC RL REG 90D	474.42	B7521A-3/4X1/4	SPLIT-EYELET CONN.BR	13.36
B56601-2-1	RPL/ASB 344B24 L/MTR	322.75	B7521A-3/4X1/8	SPLIT-EYELET CONN.BR	13.36
B56601-2-1-SS	RPL/ASB 344B24 L/MTR	445.31	B7521B-1/2X1/4	SPLT-EYLT.CON.ALL SS	33.34
B56601-2-3/4	RPL/ASB 344B23 L/MTR	322.75	B7521B-1/2X1/8	SPLT-EYLT.CON.ALL SS	33.34
B56601-2PR-3/4	344BPR SUB ASB 3/4	322.75	B7521B-1X1/4	SPLT-EYLT.CON.ALL SS	33.34
B56601-2RL-1	344BRL SUB ASB 1" BSPT	322.75	B7521B-1X1/8	SPLT-EYLT.CON.ALL SS	33.34
B56601-2RL-1-SS	344BRL SUB ASB 1 INCH	445.31	B7521B-3/4X1/4	SPLT-EYLT.CON.ALL SS	33.34
B56601-2RL-3/4	344BRL SUB ASB 3/4" BSPT	322.75	B7521B-3/4X1/8	SPLT-EYLT.CON.ALL SS	33.34
B56601-3-1	RPLBDY ASB B344B34	421.33	B7521C-1/2X1/4	SPLIT-EYELET CONN.SS	19.97
B56601-3-1-0	RPLBDY ASB B344B34	262.66	B7521C-1/2X1/8	SPLIT-EYELET CONN.SS	19.97
B56601-3-1-SS	RPL/ASB 344B34 L/MTR	517.64	B7521C-1X1/4	SPLIT-EYELET CONN.SS	19.97
B56601-3-3/4	344 W/O MOTOR HEAD BSPT	395.01	B7521C-1X1/8	SPLIT-EYELET CONN.SS	19.97
B56602-11-25-C	346B NORM OPEN 1-1/4 BSPT	859.91	B7521C-3/4X1/4	SPLIT-EYELET CONN.SS	19.97
B56602-11-25-C15	346B NORM OPEN 1-1/4 BSPT	874.33	B7521C-3/4X1/8	SPLIT-EYELET CONN.SS	19.97
B56602-11-25-D	346B NORM OPEN 1-1/4 BSPT	859.91	B7599-3/8-ENP	INLET ADAP.BSPT,BRPL	6.73
B56602-11-25S-C	346 NORM OPEN 1-1/2	1016.22	B7620-1/4X1/4	SWIVEL CONN.BSPT.BR.	13.76
B56602-11-25S-C15	346B NORM OPEN 1-1/4	1030.58	B7620-T	TEEJET SWIVEL BSPT	38.88
B56602-11-26-D	346B NORM OPEN 1-1/2	859.91	B8370A-1-1/2X1/4	SPLT-EYLT CON. BSPT	29.41
B56602-11-26S-C	346B NORM OPEN 1-1/2	1016.22	B8370A-1-1/4X1/4	SPLT-EYLT CON,BSPT	23.09

PART NO.	DESCRIPTION	U.S.DOLLARS	PART NO.	DESCRIPTION	U.S.DOLLARS
B8370A-2X1/4	SPLT-EYLT CONN.BSPT.	34.53	CP10571-3-NYB	GUIDE VANE FOR ALUM - 43, 43A & 143	12.58
B8370C-1-1/4X1/4	SPL.EYL.CONN.BSPT SS	43.31	CP10576-416SS	STEM,416SS,143-AL	30.05
B8370C-1-1/4X3/8	SPL.EYL.CONN.BSPT SS	43.31	CP1064-3	BODY,BRASS, 1/4B	13.30
B8400-1/4-PPB	1/4 PIPE PLUG BSPT	2.26	CP1064-3-SS	BODY,ST.STL., 1/4B	38.34
B9840-1/2	PRES.REL.VALVE BSPT	282.55	CP1071-0.5-AHSS	CAP,HARD.SS,1/8A&B	40.64
B9840-1/2-AL	PRES.REL.VALVE BSPT	203.42	CP1071-1-AHSS	CAP,HARD.SS,1/8A&B	40.64
B9840-3/4	PRES.REL.VAL.BR.BSPT	282.55	CP1071-10-AHSS	CAP,HARD.SS,1/8A&B	40.64
B9840-3/4-AL	PRES. REL VALVE BSPT	205.13	CP1071-2	CAP,BRASS, 1/8A&1/8B	8.39
B98450-1-1/4F	SPEC DBLE ROLLOVER VALVE W/CHK	65.37	CP1071-2-AHSS	CAP,HARD.SS,1/8A&B	40.64
B98450-1-1/4M	SPEC DBLE ROLLOVER VALVE W/CHK	65.37	CP1071-3-AHSS	CAP,HARD.SS,1/8A&B	40.64
B98450-1-3/8M	SPEC DBLE ROLLOVER VALVE W/CHK	65.37	CP1071-5	CAP,BRASS, 1/8A&1/8B	8.39
B98450-1/4F	DOUBLE ROLLOVER VALVE W/CHK BSPT-CPB98455-3	61.39	CP1071-5-AHSS	CAP,HARD.SS,1/8A&B	40.64
B98450-1/4M	DBLE ROLLOVER VALVE W/CHK BSPT	61.39	CP1071-6	CAP,BRASS, 1/8A&1/8B	8.39
B98450-2-1/4F	SPEC DBLE ROLLOVER VALVE W/CHK	66.18	CP1071-8-AHSS	CAP,HARD.SS,1/8A&B	40.64
B98450-2-1/4M	SPEC DBLE ROLLOVER VALVE W/CHK	66.18	CP1072-0-AHSS	CAP,HARD.SS,1/4A&B	32.64
B98450-2-3/8M	SPEC DBLE ROLLOVER VALVE W/CHK	66.18	CP1072-0.5-AHSS	CAP,HARD.SS,1/4A&B	32.64
B98450-3-1/4F	SPEC DBLE ROLLOVER VALVE W/CHK	65.78	CP1072-1-AHSS	CAP,HARD.SS,1/4A&B	32.64
B98450-3-3/8M	SPEC DBLE ROLLOVER VALVE W/CHK	65.78	CP1072-1-SS	CAP,ST.STL, 1/4A&B	21.78
B98450-3/8M	DBLE ROLLOVER VALVE W/CHK BSPT	61.39	CP1072-10	CAP,BRASS, 1/4A&B	15.90
B98451-1/4F	SINGLE ROLLOVER VALVE W/CHK BSPT-CPB98455-3	56.98	CP1072-10-AHSS	CAP,HARD.SS,1/4A&B	32.64
B98451-1/4M	SINGLE ROLLOVER VALVE W/CHK BSPT	56.98	CP1072-10-SS	CAP,ST.STL, 1/4A&B	21.78
B98451-3/8M	SINGLE ROLLOVER VALVE W/CHK BSPT	56.98	CP1072-11-AHSS	CAP,HARD.SS,1/4A&B	32.64
B98452-1/4F	DOUBLE ROLLOVER VALVE BSPT	48.23	CP1072-11-SS	CAP,ST.STL, 1/4A&B	21.78
B98452-1/4M	DOUBLE ROLLOVER VALVE BSPT	48.23	CP1072-12-AHSS	CAP,HARD.SS,1/4A&B	32.64
B98452-3/8M	DOUBLE ROLLOVER VALVE BSPT	48.23	CP1072-15	CAP,BRASS, 1/4A&B	15.90
B98453-1/4F	SINGLE ROLLOVER VALVE BSPT	43.84	CP1072-15-AHSS	CAP,HARD.SS,1/4A&B	32.64
B98453-1/4M	SINGLE ROLLOVER VALVE BSPT	43.84	CP1072-15-SS	CAP,ST.STL, 1/4A&B	21.78
B98453-3/8M	SINGLE ROLLOVER VALVE BSPT	43.84	CP1072-17-AHSS	CAP,HARD.SS,1/4A&B	32.64
BPW4000A	GUNJET SPRAY GUN	94.98	CP1072-17-SS	CAP,ST.STL, 1/4A&B	21.78
BPW4000A-1/4X1/4	GUNJET SPRY GUN BSPT	94.98	CP1072-2	CAP,BRASS, 1/4A&B	15.90
BPW4000A-3/8X3/8	GUNJET BSPT	94.98	CP1072-2-AHSS	CAP,HARD.SS,1/4A&B	32.64
BPW4000AS	GUNJET BSPT	129.45	CP1072-2-SS	CAP,ST.STL, 1/4A&B	21.78
BPW4000AS-3/8X3/8	GUNJET BSPT	129.45	CP1072-20	CAP,BRASS, 1/4A&B	15.90
BQJ1/4T-NYB	QJ-1/4T BSPT QUICKJT.BODY	4.14	CP1072-20-AHSS	CAP,HARD.SS,1/4A&B	32.64
BVSM-1/2-140	CONT.WASH.NOZ.BSPT	223.00	CP1072-20-SS	CAP,ST.STL, 1/4A&B	21.78
BVSM-1/2-190	CONT.WASH.NOZ.BSPT, VSM190-240QD8A	223.00	CP1072-25	CAP,BRASS, 1/4A&B	15.90
BVSM-1/2-28	CONT.WASH.NOZ.BSPT	60.75	CP1072-25-AHSS	CAP,HARD.SS,1/4A&B	32.64
BVSM-1/2-44	CONT.WASH.NOZ.BSPT	60.75	CP1072-25-SS	CAP,ST.STL, 1/4A&B	21.78
BVSM-1/2-90	CONT.WASH.NOZ.BSPT	60.75	CP1072-3	CAP,BRASS, 1/4A&B	15.90
BVSM-3/4-140	CONT.WASH.NOZ.BSPT	623.10	CP1072-3-AHSS	CAP,HARD.SS,1/4A&B	32.64
BVSM-3/4-190	CONT.WASH.NOZ.BSPT	623.10	CP1072-3-SS	CAP,ST.STL, 1/4A&B	21.78
BVSM-3/4-53	CONT.WASH.NOZ.BSPT	659.14	CP1072-3.5-SS	CAP,ST.STL, 1/4A&B	21.78
BVSM-3/4-90	CONT.WASH.NOZ.BSPT	623.10	CP1072-4	CAP,BRASS, 1/4A&B	15.90
CP10132	ORIF.RET,131DDTC,BR.	3.05	CP1072-4-AHSS	CAP,HARD.SS,1/4A&B	32.64
CP10566	NOZ.HOUSING,BR,10875	27.62	CP1072-4-SS	CAP,ST.STL, 1/4A&B	21.78
CP10566-AL	NOZ.HOUSING,AL,10875	26.60	CP1072-4.5-SS	CAP,ST.STL, 1/4A&B	21.78
CP10568-302SS	WASHER,302SS,43	1.13	CP1072-5	CAP,BRASS, 1/4A&B	15.90
CP10569-NY	SEAT PLATE,NYLON,#43	2.36	CP1072-5-AHSS	CAP,HARD.SS,1/4A&B	32.64
CP10570	SEAT PLUG,BRASS,43	7.69	CP1072-5-SS	CAP,ST.STL, 1/4A&B	21.78
CP10570-AL	SEAT PLUG,ALUM,43-AL	9.01	CP1072-7-AHSS	CAP,HARD.SS,1/4A&B	32.64
CP10571-2-NYB	GUIDE VANE FOR BRASS 43&43A	12.16	CP1072-7-SS	CAP,ST.STL, 1/4A&B	21.78
			CP1072-8	CAP,BRASS, 1/4A&B	15.90
			CP1072-8-AHSS	CAP,HARD.SS,1/4A&B	32.64
			CP1072-8-SS	CAP,ST.STL, 1/4A&B	21.78
			CP10736-INP	LOCK SPRNG,INP,10742	5.38
			CP10823-0.5	BODY,BRASS,1/8AX	12.11
			CP10823-1	BODY,BRASS,1/8AX	12.11
			CP10823-10	BODY BRASS 1/8AX	12.11
			CP10823-2	BODY,BRASS,1/8AX	12.11
			CP10823-3	BODY,BRASS,1/8AX	12.11
			CP10823-5	BODY,BRASS,1/8AX	12.11
			CP10823-8	BODY,BRASS,1/8AX	12.11
			CP10825-0.5	BODY,BRASS,1/8BX	12.11

PART NO.	DESCRIPTION	U.S.DOLLARS	PART NO.	DESCRIPTION	U.S.DOLLARS
CP10825-1	BODY,BRASS,1/8BX	12.11	CP114440A-5-CE	CP25611 REP. Q.T.CAP CE GREEN	1.13
CP10825-10	BODY,BRASS,1/8BX	12.11	CP114440A-6-CE	CP25611 REP. Q.T.CAP CE YELLOW	1.13
CP10825-2	BODY,BRASS,1/8BX	12.11	CP114440A-7-CE	CP25611 REP. Q.T.CAP CE BROWN	1.13
CP10825-3	BODY,BRASS,1/8BX	12.11	CP114440A-8-CE	CP25611 REP. Q.T.CAP CE ORANGE	1.13
CP10825-5	BODY,BRASS,1/8BX	12.11	CP114440A-9-CE	CP25611 REP. Q.T.CAP CE GRAY	1.13
CP10825-8	BODY,BRASS,1/8BX	12.11	CP114442A-1-CE	CP25597 REP. Q.T. CAP CE BLACK	1.30
CP11113-I-ZP	UP.CLAMP,STL-PL,111-	6.17	CP114442A-10-CE	CP25597 REP. Q.T. CAP CE VIOLET	1.30
CP11114-I-ZP	LO.CLAMP,STL-PL,111-	7.08	CP114442A-11-CE	CP25597 REP. Q.T. CAP CE LIGHT BLUE	1.30
CP11118-1	SIPHON CAP,BRSS,6290	14.35	CP114442A-2-CE	CP25597 REP. Q.T. CAP CE WHITE	1.30
CP11118-1-AL	SIPHON CAP,ALUM,6290	13.91	CP114442A-3-CE	CP25597 REP. Q.T. CAP CE RED	1.30
CP11118-10	SIPHON CAP,BRSS,6290	14.35	CP114442A-4-CE	CP25597 REP. Q.T. CAP CE BLUE	1.30
CP11118-10-AL	SIPHON CAP,ALUM,6290	13.91	CP114442A-5-CE	CP25597 REP. Q.T. CAP CE GREEN	1.30
CP11118-2	SIPHON CAP,BRSS,6290	14.35	CP114442A-6-CE	CP25597 REP. Q.T. CAP CE YELLOW	1.30
CP11118-2-AL	SIPHON CAP,ALUM,6290	13.91	CP114442A-7-CE	CP25597 REP. Q.T. CAP CE BROWN	1.30
CP11118-3	SIPHON CAP,BRSS,6290	14.35	CP114442A-8-CE	CP25597 REP. Q.T. CAP CE ORANGE	1.30
CP11118-3-AL	SIPHON CAP,ALUM,6290	13.91	CP114442A-9-CE	CP25597 REP. Q.T. CAP CE GRAY	1.30
CP11118-5	SIPHON CAP,BRSS,6290	14.35	CP114444A-1-CE	CP25607 REP. Q.T.CAP CE BLACK	1.30
CP11118-5-AL	SIPHON CAP,ALUM,6290	13.91	CP114444A-10-CE	CP25607 REP. Q.T.CAP CE VIOLET	1.30
CP11118-8	SIPHON CAP,BRSS,6290	14.35	CP114444A-11-CE	CP25607 REP. Q.T.CAP CE LIGHT BLUE	1.30
CP11118-8-AL	SIPHON CAP,ALUM,6290	13.91	CP114444A-2-CE	CP25607 REP. Q.T.CAP CE WHITE	1.30
CP11142-AL	ADAPTER,ALUM,43AL-	15.97	CP114444A-3-CE	CP25607 REP. Q.T.CAP CE RED	1.30
CP11165-I-ZP	UP.CLAMP,STL-PL,111-	4.20	CP114444A-4-CE	CP25607 REP. Q.T.CAP CE BLUE	1.30
CP11166-I-ZP	LO.CLAMP,STL-PL,111-	4.80	CP114444A-5-CE	CP25607 REP. Q.T.CAP CE GREEN	1.30
CP11212	20DEG.ADAPTR,BR,22PC	16.56	CP114444A-6-CE	CP25607 REP. Q.T.CAP CE YELLOW	1.30
CP11321-I-ZP	UP.CLAMP,STL-PL,111-	3.85	CP114444A-7-CE	CP25607 REP. Q.T.CAP CE BROWN	1.30
CP11322-I-ZP	LO.CLAMP,STL-PL,111-	4.35	CP114444A-8-CE	CP25607 REP. Q.T.CAP CE ORANGE	1.30
CP11422-TEF	GASKET,TEFLON,	2.37	CP114444A-9-CE	CP25607 REP. Q.T.CAP CE GRAY	1.30
CP11432-SSP	BODY F/11430-1/4-SS,303SEP	24.34	CP114501A-1-CE	Q.T. CAP CE BLACK	2.13
CP114384	3/8 PTC QC ADPTR	54.77	CP114501A-11-CE	Q.T. CAP CE LIGHT BLUE	2.13
CP114386-QC-PP	AA122 ML QC STR HEAD, PP	18.25	CP114501A-12-CE	Q.T. CAP CE RASBERRY RED	2.13
CP114387-QC-PP	AA122 ML QC BOWL, PP	15.81	CP114501A-13-CE	Q.T. CAP CE YELLOW GREEN	2.13
CP114395-1-NYB	QT CAP NY LT BLACK	1.30	CP114501A-2-CE	Q.T. CAP CE WHITE	2.13
CP114395-7-NYB	QT CAP NY LT BROWN	1.30	CP115540-1-PP	530A VALVE BODY	20.37
CP114402-1/4	114402-1/4 PLUG IN ELBOW	12.04	CP115541-NYB	VENDOR PART ONLY - 530 VALVE BODY OUTLET	11.91
CP114402-3/8	PLUG IN ELBOW	12.04	CP115547-NYB	530 ALIGNMENT PIECE	2.89
CP114402-5/16	114402-5/16 PLUG IN ELBOW	12.04	CP115548-10-I-ZP	530 THREADED ROD	18.60
CP114409-NYB	QJS END CAP, BLACK NYLON	6.40	CP115548-11-I-ZP	530 THREADED ROD	18.60
CP114414-NYB	QJS-D PLUG INSERT	3.24	CP115548-12-I-ZP	530 THREADED ROD	18.60
CP114416-CE	QJ370 20MM BODY	7.43	CP115548-13-I-ZP	530 THREADED ROD	18.60
CP114417-CE	QJ370 1/2" BODY	7.43	CP115548-14-I-ZP	530 THREADED ROD	18.60
CP114418-CE	3/4" SPLIT EYELET BODY BLACK CELCON	7.43	CP115548-15-I-ZP	#15 M6X1 THREADED ROD F/ 15 MANIFOLD	18.60
CP114419-CE	QJ370 1" BODY	7.43	CP115548-2-I-ZP	530 THREADED ROD	18.60
CP114421-NYB	QJ370 3 OUTLET TURRET, NYLON	6.72	CP115548-3-I-ZP	530 THREADED ROD	18.60
CP114422-NYB	QJ370 5 OUTLET TURRET, NYLON	7.71	CP115548-4-I-ZP	530 THREADED ROD	18.60
CP114424-NYB	QJ370 CLIP, NYLON	2.16	CP115548-5-I-ZP	530 THREADED ROD	18.60
CP114426-VI	QJ370 SEAL, VITON	8.16	CP115548-6-I-ZP	530 THREADED ROD	18.60
CP114427-15-NYB	QJ370 PLUG FOR QJS, NYLON	2.12	CP115548-7-I-ZP	530 THREADED ROD	18.60
CP114427-NYB	QJ370 PLUG, NYLON	2.12	CP115548-8-I-ZP	530 THREADED ROD	18.60
CP114436-NYB	LQC X 90 X 1" HB	20.56	CP115548-9-I-ZP	530 THREADED ROD	18.60
CP114436-PP	LQC X 90 X 1" HB	20.56	CP115549-I-ZP	M6X1 METRIC HEX STAND OFF	3.76
CP114437-NYB	LQC X 90 X 1-1/4" HB	20.56	CP115562-VI	GASKET	3.54
CP114437-PP	LQC X 90 X 1-1/4" HB	20.56	CP115565-304SS	BYPASS RETAINING CLIP, 304SS	18.93
CP114438-NYB	LQC X 90 X 1-1/2" HB	20.56	CP115568-NYB	3/4" F NPT BOLTED FLANGED AD	34.93
CP114438-PP	LQC X 90 X 1-1/2" HB	20.56	CP115569-SS	530A CLIP	7.95
CP114439-NYB	LQC X 90 X 2" HB	20.56	CP115629-SS	INLET BODY SS CASTING	98.27
CP114439-PP	LQC X 90 X 2" HB	20.56	CP1157-3	KNOB,BRASS,5927	8.23
CP114440A-1-CE	CP25611 REP. Q.T.CAP CE BLACK	1.13			
CP114440A-10-CE	CP25611 REP. Q.T.CAP CE VIOLET	1.13			
CP114440A-11-CE	CP25611 REP. Q.T.CAP CE LIGHT BLUE	1.13			
CP114440A-2-CE	CP25611 REP. Q.T.CAP CE WHITE	1.13			
CP114440A-3-CE	CP25611 REP. Q.T.CAP CE RED	1.13			
CP114440A-4-CE	CP25611 REP. Q.T.CAP CE BLUE	1.13			



PART NO.	DESCRIPTION	U.S.DOLLARS	PART NO.	DESCRIPTION	U.S.DOLLARS
CP115834A-1-CE	TTI CAP CE BLACK	1.30	CP11882-1/4	OUT.BDY,BR,110-1/4 &	28.23
CP115834A-10-CE	TTI CAP CE VIOLET	1.30	CP11882-3/8	OUT.BDY,BR,110-3/8 &	28.23
CP115834A-3-CE	TTI CAP CE RED	1.30	CP11883-1/4	IN.ADPTR,BR,110-1/4	13.98
CP115834A-4-CE	TTI CAP CE BLUE	1.30	CP11883-1/4-CHSS	IN.ADPTR,HSS,110-1/4	36.28
CP115834A-5-CE	TTI CAP CE GREEN	1.30	CP11883-3/8	IN.ADPTR,BR,110-3/8	13.98
CP115834A-6-CE	TTI CAP CE YELLOW	1.30	CP11883-3/8-CHSS	IN.ADPTR,HSS,110-3/8	36.28
CP115834A-7-CE	TTI CAP CE BROWN	1.30	CP11884	GUID.SEAT,BR,110-1/4	12.77
CP115834A-9-CE	TTI CAP CE GREY	1.30	CP11884-CHSS	GUIDE SEAT,HSS,110-	33.47
CP115881-12	115880 12V COIL ASSEMBLY	172.20	CP11885	SPRG.RET.,BR,110-1/4	3.35
CP115881-24	115880 24V COIL ASSEMBLY	172.20	CP11886-.5-302SS	SPRING 302SS,110-1/4	8.11
CP116215-NYB	1-1/4" HB OUTLET X M LQC	20.07	CP11886-1.5-302SS	SPRING,302SS,110-1/4	8.30
CP116216-NYB	1-1/2" HB OUTLET X M LQC	20.07	CP11886-3-302SS	SPRING,302SS,110-1/4	8.11
CP116217-NYB	LQC PLUG	20.07	CP11886-7-302SS	SPRING,302SS,110-1/4	8.11
CP116218-NYB	FEMALE LQC CROSS	43.16	CP11887	ADJ.HDLE.ASB.BR.110-	12.77
CP116221-NYB	END CAP NYLON 344/364 LQC	29.56	CP11888	ADJ.STEM,BR,110-1/4	6.36
CP116222-NYB	END CAP NYLON 346/366 LQC	32.30	CP11889	HANDLE ROD,BR,110-	9.64
CP116225-NYB	BODY 2-WAY POLYPRO 366 VALVE	20.37	CP11890	LOCKNUT,BR,110-1/4 &	3.49
CP116230-25-SS	M6X1X25MM SOCKET HEAD SCREW	6.29	CP11893	BODY,BRASS,110-1 &	196.95
CP116230-30-SS	M6X30 LONG SOCKETHEAD CAP SCREW 30mm	5.11	CP11893-AL	BODY,ALUMINUM,110-1	83.53
CP116231-NYB	ECS TOOL	8.24	CP11893-DI	BODY,DUCT.IRON,110-1	109.05
CP116232-NY	TIP/CAP MULTI-TOOL	10.26	CP11895	BONNET,BRASS,110-1 &	108.78
CP116237-NYB	QUICK CONNECT END CAP NYB	36.72	CP11895-AL	BONNET,ALUM.,110-1 &	62.89
CP116241-1-1/4-NYB	:BOLTED FLANGE GAUGE PT 1/4 NPT	20.43	CP11895-DI	BONNET,DU.IRON,110-1	95.99
CP116241-1-3/8-NYB	BOLTED FLANGE GAUGE PT 3/8 NPT	20.43	CP11896	INL.ADPTR,BR,110-1	48.79
CP116241-NYB	FLANGE END CAP	20.43	CP11896-AL	INL.ADPTR AL,110-1	47.01
CP116267-PP	3/4" FNPT X 3/4" NPT THD 90 ELBOW	7.08	CP11896-I	INL.ADPTR,IR,110-1	47.01
CP116268-PP	3/4" NPT THD X 1/2" 90 HOSEBARB	7.08	CP11897	SPR.RETAINR,BR,110-1	9.61
CP116269-PP	3/4" NPT THD X 3/4" 90 HOSEBARB	7.08	CP11897-AL	SPR.RETAINR,AL,110-1	9.26
CP11632-1-AL	HANDLE,ALUM,25-	220.04	CP11897-I	SPR.RETAINR,STL,110-	9.26
CP11633-INP	TRGR.GUARD,STL-PL,25	11.40	CP11898	GUIDE SEAT,BR,110-1	48.79
CP11650	BODY,BRASS,11380-1	24.32	CP11898-AL	GUIDE SEAT,AL,110-1	47.01
CP11652	BODY,BRASS,11380-2	28.95	CP11898-I	GUIDE SEAT,STL,110-1	47.01
CP116880-NYB	QJS-D MAIN BODY, BLACK NYLON	31.67	CP11901	BODY,BRASS,110-1-1/4	209.14
CP116890-NYB	QJS-Y BODY	26.58	CP11901-AL	BODY,ALUM,110-1-1/4	107.58
CP11714-PHSS	SPRING,PHSS,PRV	12.68	CP11901-DI	BDY,DCT.IR,110-1-1/4	173.83
CP11731	CAP,BR,5700 MULTEEJT	6.36	CP11902	INL.ADPTR,BR,110-	54.90
CP11741	SWIVEL BODY, BRASS F/11740	22.19	CP11902-AL	INL ADAPTR,AL,110-	47.01
CP11742	RETAINER .BODY,BRASS, F/11740	14.03	CP11902-I	INL.ADPTR,STL,110-	47.01
CP11747	CH.VALV.BDY,BR, F/11750	6.07	CP11905	BODY,BR,110-1-1/2	256.79
CP11747-AL	CH.VALV.BODY,AL, F/11750	7.69	CP11905-AL	BODY,ALUM,110-1-1/2	99.93
CP11747-SS	CH.VALV.BODY,SS, F/11750	18.32	CP11905-DI	BODY,DU.IR,110-1-1/2	136.95
CP11748-302SS	SPRING RETAINER,302SS	14.90	CP11907	BONNET,BR,110-1-1/2	169.46
CP11749-10-302SS	#10 LB. SPRING,302SS,F/11750	2.30	CP11907-1-DI	BONNET,IRN,110-1-1/2	108.46
CP11749-5-302SS	SPRING,302SS,11750	2.30	CP11907-AL	BONNET,AL,110-1-1/2	93.15
CP11749-5A-302SS	#5 LB. SPRING SPRING,302SS,F/11750	2.37	CP11907-DI	BONNET,IRN,110-1-1/2	108.46
CP11754-NY	WASHER,NYLON, F/11740	2.92	CP11908	INL.ADPTR,BR,110-	66.91
CP11757-SS	SCREW,ST.STL.	6.19	CP11908-AL	INL.ADPTR,AL,110-	58.65
CP11768-SS	SHT-OFF NDL.ASB.S.S.	51.54	CP11908-I	INL.ADPTR,IRN,110-	58.65
CP11771-1/1/4	ADAPTER,BR,43-11767	39.38	CP11909	SPR.RETAINR,BR,110-	14.03
CP11772	PACKING SCREW,BRASS	28.01	CP11909-AL	SPR.RETAINR,AL,110-	13.58
CP11773-TEF	PACKING,TEFLON	8.23	CP11909-I	SPR.RETAINR,STL,110-	13.58
CP11774-302SS	PACKING WASHER,302SS	12.80	CP11943	GU.SEAT,BR,110-1-1/2	60.89
CP11803-SSP	OUTLET ASB.,SS,11806	189.07	CP11943-AL	GU.SEAT,AL,110-1-1/2	58.65
CP11843-AL	BODY,ALUM,1-1/4ATWAL	179.88	CP11943-I	SEAT,STEEL,110-1-1/2	79.62
CP11844-304SS	3/4PIPE NIPPLE,304SS	23.44	CP11944-302SS	SPRING,302SS,110-1	14.78
CP11881	BONNET,BRASS,110-1/4	13.98	CP11944-50-302SS	SPRING,302SS,110-1	14.78
CP11881-1	BONNET,BRASS,EXT THREADED	13.98	CP11945-302SS	SPRNG,302SS110-1-1/2	26.50
			CP11981	BODY,BRASS,11980-1/8	20.90
			CP11983-AL	SHT-OFF STEM KNOB,AL	8.47
			CP11992	SWIVEL BODY,BRASS	12.02
			CP11992-1	SWIVEL BODY,BRASS	12.02
			CP11993	BODY, BRASS,11990	9.61
			CP11994	CAP,BRASS,11990	6.83
			CP11995	RET.RING,BRASS,11990	4.16

PART NO.	DESCRIPTION	U.S.DOLLARS	PART NO.	DESCRIPTION	U.S.DOLLARS
CP11996-DEL	WASHER,DELIRIN,11990	3.64	CP12291-VI	GASKET,VITON,124	22.79
CP11996-NY	WASHER,NYLON, 11990	3.64	CP12322	TEEJET STR.BDY,L TIP	4.81
CP11998-BU	O-RING,BUNA-N,11990	5.41	CP12330-3045S	RETAINER PLATE,3045S F/12328	41.18
CP11998-VI	O-RING,VITON,11990	7.75	CP12330-IZP	RETAINER PLATE,IZP	19.74
CP11999	SWIVEL BODY,BRASS	11.26	CP12331-2-CEB	BONNET CELCON,12328	40.74
CP12000	BODY, BRASS,11990	7.63	CP12332-1/2-NYB	BODY,NYLON,12328-1/2	32.42
CP12001	BODY,BRASS,F,11990	7.63	CP12332-3/4-NYB	BODY,NYLON,12328-3/4	32.42
CP12002	SWIVEL BODY,M,BRASS	9.49	CP12333-NY	INSERT BLACK, NYLON F/12328	24.23
CP12003	SWIVEL BODY,M,BRASS	9.49	CP12333-SS	INSERT,ST.STL,12328	24.72
CP12004-302SS	KEEPERS,302SS,11990	4.80	CP12334-2-CEB	DISC CELCON 12328	11.82
CP12023-TEF	PACKNG,TEF,DIRCTOVAL	7.71	CP12335-FA	DIAPHRAGM,FAIR,12328	6.09
CP12025	STR.BODY,BRASS,12024	5.23	CP12335-VI	DIAPHRGM,VITON,12328	14.44
CP12026	BALL RETANR,BR,12024	5.61	CP12336-302SS	SNAP RING,302SS12328	2.79
CP12027-SS	SNAP RING, SS, 12024	2.41	CP12337-302SS	SPRING,302SS,12328-	5.38
CP12094-NYB	TEEJET BODY,NYLON	2.37	CP1237	BODY,BRASS,1/2A	24.15
CP12107-SS	RETAINING RING,SS	8.09	CP12382	BODY,BRASS,12381	69.48
CP12126-AL	COVER PLATE,ALUM,#17	75.96	CP12382-SS	BODY,ST.STL.12381	178.04
CP12127-CE	SEL.SHLD.TIP,CEL,#17	6.07	CP12383-NY	SPACER-RING SEAT,NYLON	9.60
CP12128-IZP	SELCT.SHLD,STL-PD,17	9.13	CP12432	TIP BODY,BRASS,12430	36.97
CP12129-CE	SPACER,CELCON,#17-	8.15	CP12433	CORE, BRASS,12430	42.71
CP12130-SS	PACKING GLAND,SS,#17	11.65	CP12434	LOCKNUT,BRASS, 12430	10.65
CP12152-2-AL	BODY,ALUM,12150-AL	172.08	CP12442	BODY,BRASS,M,11990	11.73
CP12152-2-I	BODY,IRON,12150-I	232.54	CP12443	BODY,BRASS,F,11990	11.73
CP12152-AL	BODY,ALUM,12150-AL	172.08	CP12444	SWIVEL BODY,M,BRASS	13.08
CP12152-I	BODY,IRON,12150-I	232.54	CP12445	SWIVEL BODY,F,BRASS	13.08
CP12154-AL	CAP,ALUMINUM,12150-	56.75	CP12446	CAP,BRASS,11990	8.81
CP12154-I	CAP,STEEL,12150-I	60.82	CP12447-302SS	KEEPERS,302SS,11990	5.41
CP12155-ICRP	BALL,STL-PLD,12150-	172.26	CP12448-DEL	WASHER,DELIRIN,11990	4.12
CP12156-IENP	STEM RET.ST-PL,12150	19.14	CP12448-NY	WASHER,NYLON, 11990	4.12
CP12157-IENP	STEM,STEEL PLT.12150	44.43	CP12449-BU	O-RING,BUNA-N,11990	5.28
CP12160-FV	GASKET,VULC-FIBRE	5.27	CP12451	BODY,BRASS,M,11990	18.42
CP12162-NY	WASHER,NYLON,12150	3.34	CP12452	BODY,BRASS,F,11990	18.42
CP12163-IZP	ST.CAM,STL-PLD,12150	9.12	CP12453	SWIVEL BODY,BR.11990	23.61
CP12164-IZP	LEVER,STL-PLTD,12150	21.34	CP12454	SWIVEL BODY,BR.11990	23.61
CP12165-IZP	WASHER,STL-PLTD.	1.97	CP12455	CAP,BRASS,11990	12.11
CP12166-NY	BALL SUPPRT,NY,12150	26.20	CP12456-302SS	KEEPERS,302SS,11990	5.91
CP12167-302SS	SPRING,302SS,12150-	5.61	CP12457-DEL	WASHER,DELIRIN,11990	5.28
CP12168-IZP	SCREW,STL.PLTD.	6.50	CP12457-NY	WASHER,NYLON, 11990	5.28
CP12203-BU	GASKET,BUNA-N (INCL MI12521)	5.69	CP12554-15-NYB	SIPHON CAP,NY,#12381	61.13
CP12285-1-SS	SCREEN,SS,16M,124	30.47	CP12606-1	ADAPTER,BRASS	52.44
CP12285-2-SS	SCREEN,SS 50M,124-RED	30.47	CP12661-NY	GASKET,NYLON,13050	3.12
CP12285-3-SS	SCREEN,SS 80MM124-YELLOW	30.47	CP12664-TC	ORIF.INSERT,TC,12650	124.06
CP12285-4-SS	SCREEN,SS,30M,124,	30.47	CP12669-NYB	HOSE SHANK BODY,BLK	8.93
CP12285-5-SS	SCREEN,SS,200M,124-ORANGE	30.47	CP1269-ITP	BODY,STEEL-PLTD,1/4R	8.69
CP12285-6-SS	SCREEN,SS 100M,124-GREEN	30.47	CP12691-IZP	BONNET STL-PLTD12690	39.84
CP12285-7-SS	SCREEN,SS,20M,124-TAN	30.47	CP12692-CE	SEAT CELCON,12690	27.38
CP12287-1/1/2-AL	STRAINER HEAD,ALUM.	169.90	CP12694-VI	GASKET 12690 VITON	5.46
CP12287-1/1/2-I	STRAINER HEAD,C.IRON	208.88	CP12695-11/4-SS	SCREW,ST.STL,12690	6.43
CP12287-1/1/4-AL	STRAINER HEAD,ALUM.	169.90	CP12695-21/2-SS	SCREW,ST.STL,12795	6.43
CP12287-1/1/4-I	STRAINER HEAD C.IRON	208.88	CP12695-21/4-SS	SCREW,ST.STL,12795	6.43
CP12288-1-NY	BOWL NYLON,124- STR.	95.08	CP12696-ALSS	STEM SUB.ASB.AL & SS	53.92
CP12288-2-NY	BOWL, NYLON,124 BLACK STR	84.21	CP12701	SWIVEL BDY,BR,11990	9.22
CP12288-3-NY	BOWL,NYLON,124- STR	76.74	CP12702	SWIVEL BODY,BR,11990	16.67
CP12288-4-NY	BOWL BLACK NYLON 124	102.50	CP12703	SWIVEL BODY,BR,11990	16.67
CP12288-NY	BOWL,NYLON,124- STR	75.00	CP12797-CE	SEAT CELCON,12795	49.29
CP12290-1-SS	SCREEN ST.STL 16M	53.28	CP12798	BONNET,BRASS,12795	64.03
CP12290-2-SS	SCREEN SS,30M,124-YELLOW	53.28	CP12798-AL	BONNET,ALUM,12795	34.42
CP12290-3-SS	SCREEN ST.STL 50M	53.28	CP12798-I	BONNET,STEEL,12795	41.04
CP12290-4-SS	SCREEN SS,80M,124-YELLOW	53.28	CP12799-NY	GASKET,NYLON,12795	6.60
CP12290-5-SS	SCREEN,SS,8M,124-	53.28	CP12800-NY	GASKET NYLON,12795	9.00
CP12290-6-SS	SCREEN SS.6M,124-	53.28	CP12802-CE	SEAT CELCON,12795	95.99
CP12290-7-SS	SCREEN,SS,200M,124-	53.28	CP12803-AL	BONNET ALUM,12795	45.85
CP12290-8-SS	SCREEN SS,100M 124-	53.28	CP12855-IZP	UP.CLAMP,STL-PLATED	7.08
CP12291-BU	GASKET,BUNA-N,124-BLACK	7.32	CP12856-IZP	LO.CLAMP,STL-PLATED	7.50

PART NO.	DESCRIPTION	U.S.DOLLARS	PART NO.	DESCRIPTION	U.S.DOLLARS
CP12862-TEF	GASKET,TEFLON,12860	17.04	CP13329-IENP	LOCKNUT,STL PL.13325	6.95
CP12927	BODY,BRASS, F/4193A&4193B	8.24	CP13349-1	HOSE BARB CONN.BRASS	17.06
CP12927-AL	BODY,ALUMINUM,12926	7.32	CP1335	TEEJET BODY,BR, 1/8T	3.40
CP12927-SS	BODY,ST.STEEL, F/4193A&4193B	25.66	CP1335-AL	TEEJET BODY,AL.,1/8T	3.28
CP12928	CAP,BRASS, F/4193A	6.45	CP1335-SS	TEEJET BODY,SS, 1/8T	22.35
CP12928-AL	CAP,ALUMINUM,12926	4.98	CP13352	BALL,BRASS,13340	3.52
CP12928-SS	CAP,ST.STEEL F/4193A	14.69	CP13353	INLET ADAPTER,BRASS	17.52
CP12933-1/4	BODY,BRASS,36	78.48	CP13354	BODY,BR,13340-3 & -4	59.30
CP12933-1/4-ENP	BODY,BR-ELECT.NP,36	85.96	CP13354-1	BODY,BR,13340-3 & -4	57.64
CP12933-1/4-SS	BODY ST.STL.,36	260.94	CP1336	TEEJET BODY,BR,1/8TT	3.40
CP12933-3/8	BODY,BRASS,36	78.48	CP1336-AL	TEEJET BODY,AL.,1/8TT	3.28
CP12933-3/8-ENP	BODY,BR-ELECT.NP,36	85.96	CP1336-SS	TEEJET BODY,SS,1/8TT	22.35
CP12994-SS	INLET BODY ASB.S.S.	98.27	CP13362-302SS	SWIVEL PLATE,302SS	8.77
CP13006-10-302SS	#10LB SPRING GREEN,302SS	2.37	CP1339	TEEJET BODY,BR,1/2T	12.32
CP13006-20-302SS	#20 LB. SPRING BLACK,302SS, F/4193A	2.37	CP1339-SS	TEEJET BODY,SS,1/2T-	63.72
CP13006-40-302SS	#40 LB.SPRING RED COLOR,302SS,4193A	2.37	CP13397	INLET BODY ASB,13020	33.57
CP13006-5-302SS	SPRING,302SS,4193A	2.37	CP1340	TEEJET BODY,BR,1/2TT	12.32
CP13031	END PLUG,BRASS,36	7.18	CP1340-SS	TEEJET BODY,SS,1/2TT	59.86
CP13031-ENP	END PLUG,BR-ELECT.NP	10.72	CP1342-10	CAP,BRASS, 1/4A&BW	13.76
CP13032-INP	TRIGGER,STEEL-PLT,36	16.87	CP1342-15	CAP,BRASS, 1/4A&BW	13.76
CP13033-INP	TRIG.SUPPT,STL-PL,36	8.02	CP1342-2-SS	CAP,ST.STL., 1/4A&BW	40.64
CP13034	STEM,BRASS,36	6.69	CP1342-3-SS	CAP,ST.STL., 1/4A&BW	40.64
CP13034-ENP	STEM,BR-ELECT.NP,36	8.72	CP1342-5-SS	CAP,ST.STL., 1/4A&BW	40.64
CP13034-SS	STEM ST.STL.,36	17.71	CP1342-8-SS	CAP,ST.STL., 1/4A&BW	40.64
CP13035-INP	LOCK,STEEL-PLTD,36	4.41	CP13433-NYB	BODY,NYLON,13431	16.14
CP13036-302SS	VALVE SPRNG,302SS,36	9.27	CP13449-10-POL	CAP PLUG	0.42
CP13039-INP	SCR.HOUSING,ST-PL,36	3.79	CP13500	1/2X3/8R.COUPLING,BR	8.97
CP13040-INP	SCREW,STEEL-PLT,36	3.64	CP13503	ADAPTER,BRASS	13.24
CP13042-INP	SCR.HOUSING,ST-PL,36	3.26	CP13798-302SS	TRIGGER GUARD SS,50. ELECTROPOLISHED	36.28
CP13093-5/8-304SS	SCREW 304SS,111-	5.28	CP13798-INP	TRIGGER GUARD	16.00
CP13093-5/8-IZP	SCREW IZP.111-	2.37	CP14252-INP	TRIGGER INP 14250	11.41
CP13093-7/8-IZP	SCREW,IZP,111-	2.37	CP14254-NP	PACKING SCREW 14250	5.91
CP13093-7/8-SS	7/8 SCREW, 304SS	5.28	CP14255-1-BU	CUP PACKING BUNA FDA	8.61
CP13113-IZP	CLAMP,STEEL-PL,112SQ	4.63	CP14255-1-EPR	CUP PACKING RUBBER	13.81
CP13114-IZP	CLAMP,STEEL-PL,112SQ	5.23	CP14255-1-VI	CUP PACKING VITON	14.63
CP13128-SS	SPRING,ST.STL,8460-	12.32	CP14255-2-BU	CUP PACKING BUNA	13.71
CP13168-AL	HANDLE BODY,ALUMINUM	75.65	CP14255-2-VI	LIP SEAL VITON 80-	38.89
CP13190-IZP	CLAMP,STL-PLT,112SQ	9.75	CP14255-3-VI	CUP PACKING VITON	29.88
CP13191-IZP	CLAMP,STL-PLTD,112SQ	9.00	CP14260-AL	TRIGGER GUIDE YOKE	7.57
CP1321	TEEJET BODY,BR.,1/4T	3.40	CP14307-1/2-CHSS	INL.ADAPTER,6815-1/2	86.71
CP1321-AL	TEEJET BODY,AL.,1/4T	3.28	CP14307-3/4-CHSS	INL.ADAPTER,6815-3/4	86.71
CP1321-SS	TEEJET BODY,SS,1/4T	22.35	CP14308-CHSS	GUIDE SEAT 416HSS	36.03
CP13213	FLANGE ADAP.BR,13212	11.89	CP14477-1-AL	GUNJET BDY.43,STD.	82.89
CP1322	TEEJET BODY,BR,1/4TT	3.40	CP14477-4-AL	GUNJET BDY.43,COATED	96.82
CP1322-AL	TEEJET BODY,AL,1/4TT	3.28	CP14483	INSECTOJET ADAPT. BR	9.09
CP1322-NP	TEEJET BODY,BR-PLTD.	6.70	CP14483-SS	INSECTOJET ADAPT.SS.	41.82
CP1322-SS	TEEJET BODY,SS-1/4TT	22.35	CP14484-PP	TUBING NUT POLYPROP.	7.16
CP1323	TEEJET BODY,BR,3/8T	5.83	CP14569-302SS	SPRING 302SS 6815	22.10
CP1323-SS	TEEJET BODY,SS,3/8T	27.74	CP14582-AL	GUNJET HANDLE ALUM.	89.46
CP1324	TEEJET BODY,BR,3/8TT	3.40	CP14632-2-AL	HEAD,ALUM,124AL-2	351.32
CP1324-SS	TEEJET BODY,SS,3/8TT	22.35	CP14632-2-I	HEAD,IRON,124I-2	328.59
CP13249	LONG BODY BRASS QTT	12.38	CP14632-2/1/2-AL	HEAD,AL.124AL-2-1/2	351.32
CP1325	TEEJET CAP, BRASS	2.08	CP14632-2/1/2-I	HEAD,IRON 124I-2-1/2	328.59
CP1325-2-NP	TEEJET CAP,BRASS-PLD	3.44	CP14633-BU	GASKET BUNA 124	11.33
CP1325-AL	TEEJET CAP,ALUMINUM	1.99	CP14633-VI	GASKET VITON,124-2	52.93
CP1325-NP	TEEJET CAP,BRASS-PLD	3.44	CP14634-1-SS	SCREEN 16M,124 STR.	92.78
CP1325-SS	TEEJET CAP,ST.STL.	12.19	CP14634-2-SS	SCREEN 30M,124 STR.	92.78
CP13250	STRAINER BODY,QTT	5.23	CP14634-3-SS	SCREEN 50M, 124 STR.	92.78
CP13263	HOSE CONN.BR 13262-1	10.60	CP14634-4-SS	SCREEN 80M, 124 STR.	92.78
CP13316-302SS	RETAINING .RING,302SS, F/4193A	5.91	CP14634-6-SS	SCREEN 10M,124 STR.	92.78
CP13327-PHE	WASHER,PHENOL.,13325	3.44	CP14634-7-SS	SCREEN 4M, 124 STR.	185.48
CP13328-PHE	COLLAR,PHENOL.,13325	10.72	CP14634-8-SS	SCREEN 100M,124 STR.	92.78
			CP14635-NY	BOWL NYLON,124- STR.	140.62

PART NO.	DESCRIPTION	U.S.DOLLARS	PART NO.	DESCRIPTION	U.S.DOLLARS
CP14641-ENP	INLET BODY 14640,ENP	84.12	CP15251-3/8-IENP	ADAPTER,STL IENP	38.73
CP14642-INP	SPRING SCREW PLTD.	18.67	CP15251-3/8-SS	ADAPTER,ST.STL.	42.28
CP14662	HOSE BARB TAIL PIECE	34.23	CP15252-NY	PLUNGER NYLON	13.06
CP14667-302SS	HELICAL SPRING,302SS	8.98	CP15253-IENP	GRIP SUPPORT STL PL	19.18
CP14801-PP	BODY POLYPRO. 144	22.14	CP15254-VL	HAND GRIP VINYL	7.75
CP14802-1-EPR	1 SEAT WASHER RUBBER	8.20	CP15363	HOSE SHANK ADAPTER	15.58
CP14802-EPR	SEAT WASHER RUBBER	8.47	CP15402-1-AL	HEAD ALUM. 124A-1	95.99
CP14802-VI	SEAT WASHER VITON	29.70	CP15402-1-I	HEAD,IRON, 124A-1	130.14
CP14803-1-302SS	OPTIONAL SPRNG,302SS	9.85	CP15402-3/4-AL	HEAD ALUM. 124A-3/4	95.99
CP14804-1-I	BOTTOM PLATE IRON.	8.01	CP15402-3/4-I	HEAD,IRON, 124A-3/4	130.14
CP14804-3-IZP	BOTTOM PLATE F/144F-1-3 ZINC PLATED	8.01	CP15403-1-NY	BOWL NYLON S/C STR.	40.35
CP14806-SS	WASHER ST.STL. 144	8.25	CP15403-NY	BOWL NYLON 124A- STR	43.18
CP14807-SS	SEAT WASHER RET.S.S.	24.92	CP15526-AL	INLET ADAPTER ALUM.	59.24
CP14811	SPACER	2.57	CP15587-SS	HAND GRIP STUD ST.ST	37.17
CP14811-SS	SPACER ST.STL. 144	7.20	CP15590-1-IENP	INLET SUB-ASB IENP	128.31
CP14812-SS	STEM ST. STL. 144	28.20	CP15590-1-SS	INLET SUB-ASB,ST.STL	209.13
CP14813-1-IENP	RET.RING,ST.STEEL NP	3.05	CP15590-IENP	INLET SUB-ASB IENP	128.31
CP14813-2-SS	RET. RING, ST STEEL	3.05	CP15590-SS	INLET SUB-ASB,ST.STL	209.13
CP14813-IENP	RET. RING. STL.PLTD.	3.12	CP15604-IENP	GUNJET ADAPTER IENP	32.64
CP14814-IENP	JAM NUT STL.PLTD.144	8.15	CP15698	BODY BRASS 15699,EXT	18.78
CP14818-EPR	DIAPH.RUBBER 144	16.07	CP15728-PP	CLOSE NIPPLE POLYPRO	24.72
CP14818-VI	DIAPH.VITON 144	33.86	CP15733-7-302SS	SPRING ST.STL.15731	3.55
CP14819-SS	SCREW ST.STL. 144	2.79	CP15941-1-SSPP	(-1) 16 MESH SCREEN ,SSPP, BROWN RED	27.88
CP14865-NY	STEM.RET.GASKET,NY.	5.77	CP15941-2-SSPP	(-2) 30 MESH SCREEN,SSPP, FLAME RED	27.88
CP14878-R	BOOT RUBBER 144	10.86	CP15941-3-SSPP	(-3) 50 MESH SCREEN,SSPP, GENTIAN BLUE	27.88
CP14923	ADAPTER BR. 14922	18.40	CP15941-4-SSPP	(-4) 80 MESH SCREEN,SSPP, ZINC YELLOW	27.88
CP14927-3-I	COIL STRAP 144A	12.76	CP15941-5-SSPP	(-5) 100 MESH SCREEN,SSPP, TRAFFIC GREEN	27.88
CP14928	TIP ADAPTER BRASS	11.06	CP15941-6-SSPP	(-6) 120 MESH SCREEN,SSPP, BROWN	27.88
CP14929-NY	GASKET NYLON 7199E	7.08	CP15949	BODY BR.1/4MALE,7521	8.72
CP14933-SS	SCREW ST.STL. 144	2.37	CP15951-SS	SWIVEL BODY ST.STL.	59.77
CP14964-SS	END PLUG ST.STL. 36	27.95	CP15952-SS	BEARING RET.ST.STL.	40.33
CP14976	ADAPTER,BRASS,14975	21.58	CP15953-SS	MAIN STEM ST.STL.	66.49
CP15013-VL	HAND GRIP VINYL	7.64	CP15954-DELAF	FRONT BEARING DELRIN-AF	11.41
CP15027-SS	SPRING ST.STL.15026	6.82	CP15955-DELAF	BACKUP RING DELRIN-AF	6.44
CP15057-SS	VALVE SPRING ST.STL.	6.82	CP15956-DELAF	BEARING HALF DELRIN	12.68
CP15161-IENP	ARM. STOP STEEL IENP	16.72	CP15961-SS	INLET BDY.ASB.150-1	102.14
CP15162	LOWER DIA PISTON	3.78	CP15962-SS	RET.RING,S.S,150	29.71
CP15162-SS	LOWER DIA.PISTON,SS	15.70	CP15963-PP	MACH.COVER POLYPRO.	69.11
CP15163-NYB	COIL ASB. NYLON ENC.	77.12	CP15964-SS	TIP HOLDER 150,S.S.	45.35
CP15164-NYB	UPPER DIA.HSG.,NYLON	8.19	CP15966-302SS	SNAP RING 302SS, FOR 150-MULTEEJET	2.30
CP15165-NYB	LOWER DIA.HSG.,NYLON	30.37	CP15967-SS	INLET BODY,150-2,SS	101.28
CP15166-I	COIL COVER 144A	6.86	CP16052-NP	INLET BODY BR-PLTD.	34.01
CP15167-302SS	SPRING,302 ST.STEEL	8.21	CP16053-1-302SS	MAIN SPRING, SS 23L	7.43
CP15168-IENP	JAM NUT,STEEL,E.N.P.	7.84	CP16053-2-302SS	MAIN SPRING, SS,23H	7.43
CP15169-SS	WASHER, ST. STEEL	3.05	CP16054-1-AL	BODY ALUMINUM 22	51.98
CP15170-IENP	ARMATURE,STEEL,N.P.	30.80	CP16060-SS	INLET BODY ASB.S.S.	98.27
CP15236-AL	HANDLE BL.EPOXY COAT	158.01	CP16071-NP	PACKING SCREW BR-PLT	4.94
CP15237-SS	SPRING STUD ST.STL.	4.71	CP16071-SS	PACKING SCREW ST.STL	15.80
CP15238-INP	SAFETY LOCK SCREW NP	16.98	CP16072-NP	INLET BODY BR-PLTD.	34.01
CP15238-SS	SAFETY LOCK SCREW SS	50.24	CP16074-SS	INLET BODY SUB/ASB, 303SS	98.27
CP15239-SS	PACKING SCREW ST.STL	19.18	CP16101	BODY,BRASS,140B	59.37
CP15240-1-IZP	INLE BDY.SUB.ASB.IZP	120.60	CP16122-100-PUR	QUICK TACH TIP PUR	17.52
CP15240-1-SS	INLET BDY,SUB ASB.SS	172.35	CP16122-30-PUR	QUICK TACH TIP PUR	17.52
CP15240-IZP	INLE BDY.SUB.ASB.IZP	120.60	CP16122-40-PUR	QUICK TACH TIP PUR	17.52
CP15240-SS	INLET BDY,SUB ASB.SS	172.35	CP16122-50-PUR	QUICK TACH TIP PUR	17.52
CP15246-CTEF	SEAT PLATE CARB.TEF.	11.99	CP16122-60-PUR	QUICK TACH TIP PUR	17.52
CP15247-1/4-IENP	ADAPTER STL.IENP	25.42	CP16122-90-PUR	QUICK TACH TIP PUR	17.52
CP15247-1/4-SS	ADAPTER ST.STL.	46.23	CP16123-110-PUR	QUICK TACH TIP PUR.	17.52
CP15247-3/8-IENP	ADAPTER IENP	25.42			
CP15247-3/8-SS	ADAPTER ST.STL.	46.23			
CP15248-TEF	BACK UP RING TEFLON	6.82			
CP15249-18-IENP	EXTENSION IENP.50	68.69			
CP15249-18-SS	EXTENSION ST.STL.	126.67			

PART NO.	DESCRIPTION	U.S.DOLLARS	PART NO.	DESCRIPTION	U.S.DOLLARS
CP16123-120-PUR	QUICK TACH TIP PUR.	17.52	CP18531-18-AL	EXT.PIPE AL. 18530	22.57
CP16123-140-PUR	QUICK TACH TIP PUR.	17.52	CP18601-1-NYB	BODY,NYLON,145-	35.77
CP16123-160-PUR	QUICK TACH TIP PUR.	17.52	CP18602-IENP	JAM NUT,IENP, 145	18.31
CP16123-180-PUR	QUICK TACH TIP PUR.	17.52	CP18603-1-I	COIL COVER, 145H	20.51
CP16123-210-PUR	QUICK TACH TIP PUR.	17.52	CP18605-NYB	COIL ASB,NYLON,145	163.43
CP16124-302SS	SPRING 302SS 3/4KQT	3.95	CP18606-IENP	ARMATURE,IENP,145	84.06
CP16281-302SS	SPRING,302SS,16280	43.22	CP18607-NYB	UPR DIA HOUSING 145	53.16
CP16282-416SS	LOCKSCREW ST.STL.	64.52	CP18609-SS	WASHER,ST.STL.,145	9.00
CP16305-CE	BUTTERFLY CELCON 244	8.03	CP18610-SS	SEAT WASHER RET.,145	29.76
CP16307-SS	BUTTERFLY CLAMP S.S.	17.42	CP18611-EPR	SEAT WASHER,EPDM,145	16.37
CP16311-SS	SCREW ST.STL. 244	2.37	CP18611-VI	SEAT WASHER,VITN,145	25.33
CP16396-NYB	LOCKNUT NYLON	1.41	CP18612-SS	SPACER,ST.STL.,145	6.15
CP16456-PP	QUICKJET NOZ.BODY,PP	21.63	CP18613-SS	STEM,ST.STL.,145	29.51
CP16903-1-SSPP	(-1) 16 MESH SCREEN,SSPP, BROWN RED	19.80	CP18614-NYB	LWR DIA HOUSING 145	54.77
CP16903-2-SSPP	(-2) 20 MESH SCREEN,SSPP, BEIGE	19.80	CP18616-I	UPR.DIA.HSING.CLR145	19.74
CP16903-3-SSPP	(-3) 30 MESH SCREEN,SSPP, FLAME RED	19.80	CP18617-SS	LWR.DIAPPISTON,145	21.73
CP16903-4-SSPP	(-4) 50 MESH SCREEN,SSPP, GENTIAN BLUE	19.80	CP18618-IENP	ARMATURE STOP, 145	53.61
CP16903-5-SSPP	(-5) 80 MESH SCREEN,SSPP, ZINC YELLOW	19.80	CP18619-SS	SCREW,ST.STL,18600	7.83
CP16903-6-SSPP	(-6) 100 MESH SCREEN,SSPP, TRAFFIC GREEN	19.80	CP18620-304SS	SPRG.RET.,ST.STL,145	11.14
CP16903-7-SSPP	(-7) 200 MESH SCREEN,SSPP, LIGHT PINK	19.80	CP18621-EPR	DIAPHRAGM,EDPM,145	17.65
CP16947-20-AHSS	INSERT CAP, 16946	15.21	CP18621-VI	DIAPHRAGM,VITON,145	34.80
CP16947-30-AHSS	INSERT CAP, 16946	15.21	CP18622-EPR	BOOT,EPDM,145	14.50
CP16947-45-AHSS	INSERT CAP, 16946	15.21	CP18625-PP	CLOSE NIPPLE PP 145	37.32
CP16947-60-AHSS	INSERT CAP, 16946	15.21	CP18627	RETAINER BRASS,20858	8.72
CP16947-90-AHSS	INSERT CAP, 16946	15.21	CP18648-IZP	UPPER CLAMP TEEJET	6.09
CP16959-IZP	UP.CLAMP,STL-PL111SQ	7.32	CP18649-IZP	LOWER CLAMP TEEJET	7.64
CP16960-IZP	LO.CLAMP STL-PL111SQ	8.23	CP18650-IZP	UPPER CLAMP TEEJET	6.09
CP17053-2-8-SS	2.8W-TG TIP BODY	23.33	CP18651-IZP	LOWER CLAMP TEEJET	7.64
CP17088-SS	ORIF.TUBING,SS,4664A	10.95	CP18652-IZP	UPPER CLAMP TEEJET	6.09
CP17090-2-AL	DIAPH.CK.VLV.BDY.AL.	34.48	CP18653-IZP	LOWER CLAMP TEEJET	7.64
CP17103-302SS	SCREW,302SS	2.04	CP18654-IZP	UPPER CLAMP TEEJET	9.60
CP17120-SS	SNAP RING ST.STL.	8.16	CP18655-IZP	LOWER CLAMP TEEJET	12.10
CP17553-1-PP	1"UP CLMP PP GREY	4.32	CP18656-IZP	UPPER CLAMP TEEJET	7.20
CP17553-PPB	1"UP.CLMP,17560,BLK	5.96	CP18657-IZP	LOWER CLAMP TEEJET	8.90
CP17559-NYB	QT BODY,BLACK,1 CLMP	13.91	CP18658-304SS	UPPER CLAMP,304SS	5.95
CP17559-PP	QT BODY GREY 1 CLMP	7.20	CP18658-IZP	UPPER CLAMP TEEJET	8.22
CP17562-2-CE	FLCNE QT.CAP,WHITE	2.59	CP18659-304SS	LOWER CLAMP,304SS	6.36
CP17674-1/1/4-430SS	SCREW,430SS,17560	4.79	CP18659-IZP	LOWER CLAMP TEEJETS	10.36
CP17674-1/3/8-430SS	SCREW,430SS,24216	4.79	CP18667-NYB	BODY NYLON,1"CLAMP	7.33
CP17703-NY	TRIGGER 30 GUNJETS	7.83	CP18671-NYB	BODY,QJ8360 QUICKJET	6.21
CP17704-NY	TRIGGER LOCK 60 GUNS	5.11	CP18676-1/4-NYB	BODY 1/4 NYLON	11.22
CP17706	BODY 60 GUNJET	61.92	CP18676-1/8-NYB	BODY 1/8 NYLON	11.22
CP17709-SSTEF	SEAT ST.STL.+TEFLON	19.31	CP18722-IZP	UPPER CLAMP TEEJET	9.27
CP17710-1-BRBTEF	VALVE ST SUB-ASB 60W	14.50	CP18723-IZP	LOWER CLAMP TEEJET	11.72
CP17710-BRBTEF	VALVE SEAT SUB-ASB60	14.50	CP18999-EPR	SEAL EPDM RUBBER	1.67
CP17710-SSTEF	-2 VALVE SEAT SUB-ASB.	35.04	CP18999-VI	SEAL VITON	10.03
CP17712-TEF	BACK UP RING 60 GUNS	6.58	CP19012-1-NYB	BODY NYLON 8360QJT	7.02
CP17715-302SS	MAIN SPRING 60 GUNS	9.27	CP19012-2-NYB	BODY NYLON 19185	22.31
CP17717-302SS	GASKET 60-SS GUNJET	7.52	CP19012-3-NYB	BODY NYLON 19190	22.31
CP17717-AL	GASKET 60 GUNJETS	2.30	CP19012-4-NYB	BODY NYLON QJT8360 1/4F	7.02
CP17718	PACKING SCREW 60 GUN	13.06	CP19013-EPR	GASKET,EDPM,19011	3.12
CP17718-SS	PACKING SCREW 60 GUN	37.60	CP19191-R	GASKET,RUBBER,19185	2.89
CP17719-1-CE	LOCK SPRING RING #60	2.50	CP19192-R	GASKET,RUBBER,19190	4.11
CP17720-420SS	ROLL PIN 60 GUNJETS	3.16	CP19237	PACKING SCREW,43-	7.64
CP17833-302SS	RETAINER RING,302SS	2.81	CP19237-AL	PACKING SCREW,43-	7.64
CP17889-420SS	ROLL PIN 60 GUNJETS	6.15	CP19238-416SS	STEM,416SS,43H+L GUN	34.98
CP18032A-NYB	NYLON TEEJET CAP	1.93	CP19239-416SS	STEM,416SS,43A GUN	26.78
CP18294-EPR	QUICKJET SEAL,EPR	2.66	CP19268-SS	6-32 SCREW,ST.STL.	8.03
CP18294-VI	QUICKJET SEAL,VITON	11.48	CP19342-1-AL	STR.HEAD,124ML,ALUM	109.53
			CP19342-3/4-AL	STR.HEAD,124ML,ALUM	109.53
			CP19345-11/2-AL	STR.HEAD.124ML,ALUM	187.49
			CP19345-11/4-AL	STR.HEAD,124ML,ALUM	187.49
			CP19348-2-AL	STR.HEAD,124ML,ALUM	394.25
			CP19369-1/4-IENP	ADAPTER STL-PLTD	19.18

PART NO.	DESCRIPTION	U.S.DOLLARS	PART NO.	DESCRIPTION	U.S.DOLLARS
CP19438-1-EPR	SEAT WASHER, RUBBER	0.80	CP20152	BODY BRASS,4664B	27.43
CP19438-2-EPR	SEAT WASHER, RUBBER	0.80	CP20157	BODY BRASS 4666B	27.43
CP19438-EPR	SEAT WASHER,RUBBER,BLACK	0.80	CP20162-1/4	BODY BRASS,6135A	33.43
CP19438-VI	SEAT WASHER,VITON	3.18	CP20162-3/8	BODY BRASS,6135A	33.43
CP19462-NYB	BODY QJ8600 NYLON	7.37	CP20167	10742A -1/4-18 NPT CHECK VALVE	43.89
CP19463-1-430SS	STUD QJ8600 SGL.SWV.	6.17	CP20167-1	1/8 BODY, 10742A	43.89
CP19463-2-430SS	STUD QJ8600 DBL.SVL.	6.58	CP20167-AL	1/4-18 NPT BODY CHECK VALVE, ALUM F/10742A	42.27
CP19588-IZP	UPPER CLAMP STL-PLTD	7.18	CP20206-SS	FLAT WASHER, DIRECTO	2.30
CP19589-IZP	LOWER CLAMP STL-PLTD	8.03	CP20229-NY	GASKET NYLON,20230	1.79
CP19615-1-316SS	COUPLER 316SS,19610	254.77	CP20230	CAP,BRASS.	2.46
CP19682-1-NYB	HOUSING SET NYLON	65.96	CP20266-EPDM	GASKET RUBBER,QJT	2.79
CP19682-NYB	HOUSING SET NYLON	65.96	CP20266-VI	GASKET	3.96
CP19683-NYB	HOUSING SET NYLON	64.52	CP20564-VI	BALL VALVE GASKET VI	5.28
CP19684-1-NYB	RIGHT & LEFT HAND HOUSING SET, 30 GUN	96.72	CP20573-PP	RET CAP 20570 GRAY	1.32
CP19684-NYB	HOUSING SET NYLON	68.42	CP20582-1/2-PPB	THREADED BALL,20570	11.74
CP19804	INLET BODY,30 GUN	38.68	CP20582-1/4-PPB	THREADED BALL,20570	6.10
CP19805-CE	LOCK SPR.RING,CELCON	2.78	CP20582-3/8-PPB	THREADED BALL,20570	6.10
CP19806-NY	TRIGGER LOCK,NYLON	8.23	CP20607-IZP	CAP SCREW,STEEL ZP	3.40
CP19807-BR302S	STEM ASB.30 GUN	11.58	CP20674-IZP	#10 LOCK WASHER,STL	2.92
CP19810	TRIGGER GUIDE,30 GUN	15.24	CP20833-IENP	ADAP.STL-PLTD.30 GUN	14.25
CP19811	PACKING SCREW,30 GUN	6.82	CP20833-NP	ADAPTER,21550	16.81
CP19812	GASKET BRASS 30 GUN	5.70	CP20902-316SS	HANDLE, 316SS, 20900	10.66
CP19813-1-BRBTEF	VLV.SEAT,ASB.30W GUN	8.23	CP20908-SS	SLOTTED HEX SCREW SS	1.30
CP19813-BRBTEF	VALV.SEAT,ASB.30 GUN	8.23	CP20938	INLET BODY BRASS	58.90
CP19815	SPRING GUIDE,30 GUN	13.11	CP20939-BR302S	STEM SUB-ASB.BR&SS..	30.31
CP19816	SPRING RET.30 GUN	6.70	CP20941-BRTF	TIP SUB-ASB.BR&TEF.	18.25
CP19817-302SS	SPRING,302SS,30 GUN	5.98	CP21034-AL	BYPASS ADAPTER ALUM.	86.92
CP19818-SS	SCREW SS,30 GUN	2.30	CP21035-NY	BOWL,NY,124ML,SC STR	63.63
CP19819-SS	WASHER,ST.STL.30 GUN	2.30	CP21046-1.5-GLASS	FUSE GLASS,901	3.90
CP19820-420SS	ROLL PIN,420SS,30GUN	4.96	CP21060-VI	BALL,VITON,CHK.VALVE	2.79
CP19926-2-SS	BALL,450 FLOWBACK	119.81	CP21112-SS	BODY SUB-ASB.ST.STL.	287.61
CP19926-SS	BALL TWO WAY ST.STL.	94.64	CP21113-SS	INLET BODY,ST.STL.	168.43
CP20016-NY	CLEANOFF BRUSH TEEJT	13.63	CP21114-SS	INLET STUD ST.STL.	79.10
CP20029-1-SS	WELD TYPE BODY, SS	14.10	CP21399-1-CE	QT CAP CELCON BLACK	1.16
CP20029-SS	WELD TYPE TEEJET BDY	14.10	CP21399-10-CE	QT CAP CELCON VIOLET	1.16
CP20101-NYB	BODY,2 WAY 344E,NY.	32.90	CP21399-2-CE	QT CAP CELCON WHITE	1.16
CP20101-PP	BODY 2/WAY POLYPRO.	20.76	CP21399-3-CE	QT CAP CELCON RED	1.16
CP20102-1-NYB	BODY 3 WAY 344E NY.	66.62	CP21399-4-CE	QT CAP CELCON BLUE	1.16
CP20102-1-PP	3 WAY BODY, 1 IN,PP	44.33	CP21399-5-CE	QT CAP CELCON GREEN	1.16
CP20102-3/4-NYB	BODY 3 WAY 344E NY.	66.62	CP21399-6-CE	QT CAP CELCON YELLOW	1.16
CP20102-3/4-PP	3 WAY BODY, PP	44.33	CP21399-7-CE	QT CAP CELCON BROWN	1.16
CP20103-CTEF	TEFLON SEAL, BLACK	20.22	CP21399-8-CE	QT CAP CELCON ORANGE	1.16
CP20103-TEF	TEFLON SEAL,WHITE	11.05	CP21471-1-NY	WHITE NYLON WASHER	2.37
CP20104-1-NYB	END CAP 344E NYLON	30.16	CP21484-COMMAT	MASTER SWITCH	71.37
CP20104-1-PP	END CAP POLYPRO.	30.16	CP21547-3/8-IZP	SLOTTED SCREW 3/8	2.37
CP20104-3/4-NYB	END CAP 344E,NYLON	30.16	CP21551-1/4	SWIVEL BODY,BRASS	14.85
CP20104-3/4-PP	END CAP POLYPRO.	30.16	CP21551-3/8	SWIVEL BODY,BRASS	14.85
CP20104-B-NYB	BLANK END CAP 344B	30.16	CP21552	BEARING RET.BR.21550	8.72
CP20106-1-PP	344-2 BALL F/SS STEM	13.57	CP21552-NP	BEARING RETAINER,NP F/21550 HI-PRESS SWIVEL	25.13
CP20106-2-PP	BALL,450 FLOWBACK	29.28	CP21553-NP	STEM END NUT BR-PLT.	31.80
CP20106-PP	344A-2 BALL F/NY STE	13.57	CP21554-DELAF	THRUST BEARING DELAF	17.65
CP20109-1-PP	3 WAY BALL	18.19	CP21555	MAIN STEM BR. 21550	12.95
CP20109-PP	BALL 3 WAY 344E,PP	18.19	CP21556	STEM END NUT BRASS	11.82
CP20116-PP	HANDLE POLYPRO-344M	8.72	CP21556-NP	STEM END NUT,21550	31.80
CP20117-NYB	MOUNTING PLATE NYLON	7.79	CP21569-2-CE	QT CAP CELCON,WHITE	1.67
CP20123-1-1/4-430SS	HEAD SCREW 430SS	4.96	CP21569-3-CE	QT CAP CELCON,RED	1.67
CP20123-3/4-430SS	HEAD SCREW 3/4,430SS	3.34	CP21661-NP	SWIVEL BODY,21550	22.79
CP20125-TEF	THRUST WASHER 344E	2.37	CP21672-1-PPB	BODY,POLYPRO,144-1-3	41.80
CP20127-SS	CLINCHING STUD 344E	2.37	CP21673-SS	SCREW ST STL 144	6.86
CP20128-SS	LOCK WASHER,344E,SS	2.37	CP21674	STEM	17.85
CP20129-SS	HEAD CAP SCREW 344E	4.20	CP21674-SS	STEM ST.STL.144-1-3	39.93
CP20131-EPR	HANDLE PLUG RUBBER	2.43			
CP20138	SPRING RET.BRASS	3.72			

PART NO.	DESCRIPTION	U.S.DOLLARS	PART NO.	DESCRIPTION	U.S.DOLLARS
CP21717-20-NEO	OUTPUT CABLE SHIELD	6.16	CP22668-PP	CAP POLYPRO,AA30-PP	2.30
CP21736-NY	MALE CONNECTOR NYLON	5.17	CP22671-IZP	GROOVE PIN STEEL ZINC PLATED	1.85
CP21737-NYB	3/4 CLOSE NIPPLE	7.08	CP22672-IZP	GROOVE PIN STEEL ZINC PLATED	1.85
CP21742-NY	POWER PLUG NYLON	3.66	CP22673-PP	45 TEEJET ADAPTER POLYPRO	2.66
CP21756-PHBR	PIN CONTACT,PHBR	1.26	CP22676-NEO	SAFETY GASKET NEOPR.	2.26
CP21759-NY	REG VALVE PLUG	3.86	CP22706-TEF	THRUST WASHER,TEFLON	2.97
CP21760-NY	CAP NYLON,AA744	4.50	CP22707-1/2-PP	END CAP,POLYPRO	21.77
CP21762-NY	BALL VALVE CAP NYLON	4.50	CP22707-3/8-PP	END CAP,POLYPRO	21.77
CP21953-EPR	DIAPH.RUBBER,21950	0.73	CP22708-TEF	SEAL,VIRGIN TEFLON	17.21
CP21953-VI	DIAPH.VITON	2.25	CP22710-PP	2 WAY BALL,POLYPRO	24.80
CP22136	BODY BRASS 30L	45.85	CP22716-PP	BALL VALVE STEM,POLY	3.25
CP22137-BR302S	STEM SUB-ASB. 30L	11.59	CP22717-PP	HANDLE,POLYPRO	12.68
CP22138-302SS	SPRING,302SS,30L	2.79	CP22719-PP	2 WAY BODY,POLYPRO	6.95
CP22190-1-NYB	1 QJ,BODY&CLAMP	8.47	CP22721-EPR	HANDLE PLUG,EPDM	4.13
CP22198-1-CE	CAP-AIRJET ONLY	4.98	CP22722-IZP	CAP SCREW,STEEL-ZINC	2.94
CP22236-3/8-NYB	SINGLE HOSE SHANK NY	14.69	CP22724-PP	RET.RING,POLYPRO	4.40
CP22236-3/8-PP	SINGLE HOSE SHANK,PP	11.43	CP22835-NYB	INNER CYLINDER, NY	64.96
CP22237-1/2-NYB	SINGLE HOSE SHANK NY	14.69	CP22836-NYB	BYPASS ADAPTER, NY	32.13
CP22237-1/2-PP	SINGLE HOSE SHANK,PP	11.43	CP22872-PHE	LIMIT SWITCH PHENOLIC F/ 344E	22.65
CP22238-3/4-NYB	SINGLE HOSE SHANK NY	14.69	CP23121-PP	BODY POLYPRO.23120 3/4	31.29
CP22238-3/4-PP	SINGLE HOSE SHANK,PP	11.43	CP23122-NY	ADJUSTING CAP,NYLON	16.63
CP22239-3/8-NYB	DOUBLE HOSE SHANK NY	14.69	CP23122A-NY	ADJ.CAP,NYLON 23120A	24.74
CP22239-3/8-PP	DOUBLE HOSE SHANK,PP	11.43	CP23123-NY	LOCKRING, NYLON	8.93
CP22240-1/2-NYB	DOUBLE HOSE SHANK NY	14.69	CP23124-PP	SPRING RETAINER,PP	8.47
CP22240-1/2-PP	DOUBLE HOSE SHANK,PP	11.43	CP23125-PP	GUIDE SEAT,POLYPRO.	6.56
CP22241-3/4-NYB	DOUBLE HOSE SHANK NY	14.69	CP23126-302SS	RETAINER PIN,302SS	5.28
CP22241-3/4-PP	DOUBLE HOSE SHANK,PP	11.43	CP23127-302SS	SPRING, 23120, 302SS	11.93
CP22259-1-PP	RL VALVE BALL, PP	55.29	CP23127-316SS	SPRING, 23120A, 316SS BLUE	22.23
CP22259-2-PP	RL BALL, PP	55.29	CP23128-PP	1/2 INCH BODY, POLYPRO,23120	31.29
CP22370-1-316SS	COUPLER 316SS,19610	159.97	CP23171-1/2-PP	1/2"NPT STRAINER.HEAD POLYPRO.	12.30
CP22377-1/1/4-316SS	COUPLER 19610-1-1/4	184.57	CP23171-3/4-PP	3/4"NPT STRAINER.HEAD POLYPRO.	12.30
CP22390-3-316SS	COUPLER,19610-3	424.23	CP23172-NY	BOWL NYLON CLEAR	13.93
CP22404-NYB	QT BODY,BLACK,3/4	7.20	CP23172-PP	BOWL POLYPRO.AA122	10.86
CP22406-NYB	BYPASS ADAPTER NYLON	17.11	CP23173-EPR	GASKET RUBBER AA122,GREY	7.04
CP22406-PP	BYPASS ADAPTER PP COLOR GRAY	27.70	CP23173-VI	GASKET VITON AA122	13.51
CP22407-420SS	SPRING PIN,21410	1.67	CP23174-1-3045S	#16 MESH SCREEN F/AA122	9.27
CP22408-PP	INNER CYLINDR.POLY P	20.27	CP23174-2-3045S	#30 MESH SCREEN F/AA122	9.27
CP22427-18-SS	STEM ST.STL. 22426	57.19	CP23174-7-3045S	#200 MESH SCREEN F/ AA122	17.04
CP22427-24-SS	STEM ST.STL. 22426	61.57	CP23215-1/4-NYB	BODY SUB-ASB,NYLON	60.01
CP22427-36-SS	STEM ST.STL. 22426	65.80	CP23215-1/8-NYB	BODY SUB-ASB NYLON	62.44
CP22427-48-SS	STEM ST.STL. 22426	183.19	CP23221-420SS	SPRING PIN,420SS	1.17
CP22427-8-SS	STEM ST.STL. 22426	52.31	CP23222-302SS	RETAINER RING 302SS	2.51
CP22476-SS	BLEED SCREW ST.STL.	1.82	CP23226-CE	SHUT-OFF HANDLE CEL.	2.84
CP22479-SS	TRIGGER GUIDE,21410	15.63	CP23307-1-CE	RETROFIT CAP BLACK	1.35
CP22568-NYB	BODY NYB 1/2 CLAMP	3.28	CP23307-10-CE	RETROFIT CAP VIOLET	1.35
CP22569-NYB	BODY,NY,3/4 CLAMP	7.58	CP23307-2-CE	RETROFIT CAP WHITE	1.35
CP22576-IZP	2-1/2" GAUGE BRACKET	56.75	CP23307-3-CE	RETROFIT CAP RED	1.35
CP22606-SS	MACHINE SCREW,21410	1.67	CP23307-4-CE	RETROFIT CAP BLUE	1.35
CP22643-PHO	CONTROL HOUSING PHO.	95.10	CP23307-5-CE	RETROFIT CAP GREEN	1.35
CP22651-PP	BODY POLYPRO.22650	12.94	CP23307-6-CE	RETROFIT CAP YELLOW	1.35
CP22652-3/8-PP	HANDLE POLYPRO.22650	8.37	CP23307-7-CE	RETROFIT CAP BROWN	1.35
CP22653-1/4-PP	HANDLE POLYPRO.22650	8.37	CP23307-8-CE	RETROFIT CAP ORANGE	1.35
CP22654-PP	HANDLE POLYPRO.22650	8.37	CP23308-EPR	SEAT WASHER RUBBER	0.93
CP22655-PP	TRIGGER POLYPR.22650	5.04	CP23433-SS	PACKING SCREW ST.STL	11.59
CP22656-NY	TRIGGER LOCK,22650	2.88	CP23437-PP	VALVE SEAT POLYPRO.	1.96
CP22657-NY	STEM NYLON,22650	2.63	CP23438-2-SS	NEEDLE SUB-ASB.ST.ST	6.54
CP22658-PP	SPRING RETAINER PP	3.43	CP23442-PP	INLET BODY POLYPRO	7.23
CP22659-PP	WASHER POLYPRO 22650	3.43	CP23477-420SS	SPRING PIN,344E-3RP	1.78
CP22660-PHSS	SPRING PHSS,22650	1.91	CP23483-1-PP	PR VALVE BALL, PP	55.29
CP22661-VI	DIAPH.VITON,22650	6.65	CP23491-PPB	TIP BODY,PP,5500-PP	1.91
CP22663-15-FRP	EXTENSION TUBE 22670	14.88	CP23492-PPB	CORE,POLYPRO,5500-PP	1.91
CP22663-24-FRP	EXTENSION TUBE 22670	24.15	CP23494-12-PP	ORIFICE INSERT,5500	5.81
CP22664-PP	FRONT END ADAPTER POLYPRO	2.77			

PART NO.	DESCRIPTION	U.S.DOLLARS	PART NO.	DESCRIPTION	U.S.DOLLARS
CP23494-14-PP	ORIFICE INSERT,5500	5.81	CP2384-3/4-AL	BODY, ALUM., 3/4TWAL	158.06
CP23494-18-PP	ORIFICE INSERT,5500	5.81	CP2384-3/4-I	BODY,CAST IRON,3/4TW	156.65
CP23494-22-PP	ORIFICE INSERT,5500	5.81	CP2386-11/2	BODY,BRASS,1-1/2TW-B	1025.38
CP23494-3-PP	ORIFICE INSERT,5500	5.81	CP2386-11/2-AL	BODY,ALUM.,1-1/2TWAL	449.71
CP23494-5-PP	ORIFICE INSERT,5500	5.81	CP2386-11/2-I	BODY,IRON, 1-1/2TW	383.60
CP23494-6-PP	ORIFICE INSERT,5500	5.81	CP2386-11/4	BODY,BRASS,1-1/4TW-B	1025.38
CP23494-8-PP	ORIFICE INSERT,5500	5.81	CP2386-11/4-AL	BODY,ALUM,1-1/4TWAL	449.71
CP23496-SR	IN-LINE FUSEHOLDER SILICONE RUBBER	35.75	CP2386-11/4-I	BODY,IRON,1-1/4TW	383.60
CP23521-1/2-PP	BODY 1/2 POLYPRO.	8.81	CP2388-2	BODY,BRASS,2TW-B	1850.54
CP23522-PP	ADJUSTING CAP POLY.P	13.11	CP2388-2-AL	BODY,ALUMINUM, 2TWAL	633.71
CP23523-PP	LOCKRING POLYPRO.	7.79	CP2388-2-I	BODY,CAST IRON,2TW	701.06
CP23524-PP	VALVE STEM POLYPRO.	10.19	CP2388-2I/2	BODY,BRASS,2-1/2TW-B	1782.20
CP23526-IZP	RETAINER RING I.PLTD	1.89	CP2388-2I/2-I	BODY,IRON, 2-1/2TW	701.06
CP23536-EPR	HANDLE PLUG 346M	2.29	CP23882-IZP	SCREW STL.ZINC-PLTD.	3.54
CP23537-PP	HANDLE POLYPRO.346M	9.38	CP23884-IZP	5/16 FLAT WASHER	1.79
CP23538-PP	MOUNTING PLATE POLYPRO	4.37	CP23896-1-1/4-SS	HEX HEAD BOLT, S.S.	1.82
CP23539-PP	BALL VALVE STEM,PP	9.96	CP23896-7/8-SS	HEX HD CAP SCREW 7/8	1.89
CP23543-PP	BALL 2 WAY,POLYPRO.	53.52	CP23898-IZP	RET.WASHER IZP.23370	3.90
CP23545-PP	BALL 3 WAY POLYPRO.	53.97	CP2391-1	CAP,BRASS,-TWB STR.	220.86
CP23546-PP	BODY 2 WAY POLYPRO.	20.37	CP2391-1-AL	CAP,ALUMINUM,-TWAL	95.45
CP23547-PP	BODY 3 WAY 1-1/4 PP.	68.53	CP2391-1-I	CAP,IRON, -TW STR.	116.32
CP23548-PP	BODY 3 WAY 1-1/2,PP.	68.53	CP23991-NY	CAP NYLON	2.97
CP23549-TEF	SEAL TEFLON,346	28.79	CP23992-SS	DEFLECTOR BLADE,SS	1.71
CP23550-TEF	THRUST WASHER TEFLON	5.25	CP23993-NYB	BLADE ACTUATOR NYLON	1.71
CP23551-PP	END CAP 1-1/2,POLYP.	31.54	CP23994-1/4	BODY,BRASS,23990	47.44
CP23552-PP	END CAP 1-1/4,POLYP.	31.54	CP23994-1/8	BODY,BRASS,23990	47.44
CP23553-IZP	STUD 5/16-18X7/8 IZP	2.41	CP23995-SS	SCREW,STAINLESS STL	1.71
CP23603	BODY&CAP SUB-ASB.BR.	57.69	CP24034A-PP	CALIBRATE CONTAINER	61.44
CP23604-16CTEF	VALVE POPPET,23600	3.97	CP24056	SLIDE VALVE BRASS	58.65
CP23605	BACKUP RING BR.23600	1.71	CP24058-1/4	INLET BODY BRASS	35.47
CP23606-302SS	POPPET SPRING 302SS	2.26	CP24058-1/8	INLET BODY BRASS	35.47
CP23607	SPACER RING BR.23600	1.71	CP24097-NYB	CAP NYLON	4.32
CP23608	VALVE SEAT BR.23600	1.71	CP24220-NYB	TURRET BODY,24216	9.71
CP23610-SS	RETAINER ST.ST.23600	1.71	CP24221-SSPV	CLIP SSPV,24216	3.85
CP23611	JAM NUT BRASS,23600	1.71	CP24222-NYB	3/4"UP.CLAMP,BLACK	4.33
CP23612-NYB	METERING CYLINDER NY	12.53	CP24223-1-NYB	20MMX7 MAIN BODY	9.71
CP23613-NY	METERING PISTON NY.	4.32	CP24223-NYB	1/2X7 MAIN BODY	9.71
CP23614-NYB	METERING RING,23600	2.08	CP24224-CE	INDEX IND.,24216	0.84
CP23615-NYB	CAP NYLON,23600	8.23	CP24225-1-NYB	1/2 TUR.BODY FOR/20M	9.71
CP23616-1-302SS	MAIN SPRING 302SS	16.76	CP24225-NYB	TURRET BODY,24216	9.71
CP23616-302SS	MAIN SPRING 302SS	16.76	CP24226-1-NYB	1/2"M UP CLAMP, BLACK	4.33
CP23617-302SS	SNAP RING SS.23600	8.08	CP24226-NYB	1/2"UP CLAMP,BLACK	4.33
CP23618	THRUST WASHER BRASS	1.71	CP24227-NYB	TURRET BODY,24216	9.71
CP23620-BRSS	STEM&RETAINER SUB-AS	16.19	CP24228-NYB	20MM UPPER CLAMP	4.33
CP23626-BTEF	VALVE POPPET,23600	5.91	CP24232-NYB	MAIN BODY	9.47
CP23771-EPR	HOSE RUBBER,23770	12.70	CP24460-1-SS	SEAT ST.STL. PW4000W	17.84
CP23773-304SS	U-BOLT 304SS,23770	17.03	CP24460-SS	SEAT ST.STL. PW4000	17.84
CP23774-IZP	CLAMP STL-PLTD.23370	6.36	CP2489-1	CAP,BRASS,2&2-1/2TWB	454.88
CP23776-IZP	ANGLE BRACKET 23770	26.69	CP2489-1-AL	CAP,ALUMINUM,-TWAL	127.29
CP23777-IZP	MTG.BRACKET 23770	73.34	CP2489-1-I	CAP,CAST IRON,-TW	204.09
CP23778-F-NYB	HOSE CLAMP NYLON	2.59	CP25595-1-NY	Q.T.CAP NY.LT.BLACK	1.30
CP23801	TUBING INSERT BRASS	1.89	CP25595-2-NY	Q.T.CAP NY.LT.WHITE	1.30
CP23802-8-NYB	TUBING NYLON-BLACK	3.96	CP25595-3-NY	Q.T.CAP NY.LT.RED	1.30
CP23803-304SS	WASHER 304SS,23830	1.91	CP25595-4-NY	Q.T.CAP NY.LT.BLUE	1.30
CP23834	DOUBLE OUTLET CYL.BR	30.65	CP25595-5-NY	Q.T.CAP NY.LT.GREEN	1.30
CP23835	SINGLE OUTLET CYL.BR	30.65	CP25595-6-NY	Q.T.CAP NY.LT.YELL.	1.30
CP23837-EPM	SEAL,EPM.ROLLOVER VL	1.93	CP25595-7-NY	Q.T.CAP NY.LT.BROWN	1.30
CP23837-VI	SEAL,VI,ROLLOVER VL	9.78	CP25595-8-NY	Q.T.CAP NY.LT.ORANG	1.30
CP2384-1	BODY,BRASS,1TW-B	484.93	CP25599-1-NY	Q.T.CAP NY.LT.BLACK	1.30
CP2384-1-AL	BODY, ALUM., 1TWAL	158.06	CP25599-2-NY	Q.T.CAP NY.LT.WHITE	1.30
CP2384-1-I	BODY, CAST IRON, 1TW	162.63	CP25599-3-NY	Q.T.CAP NY.LT.RED	1.30
CP2384-3/4	BODY,BRASS,3/4TW-B	484.93	CP25599-4-NY	Q.T.CAP NY.LT.BLUE	1.30
			CP25599-5-NY	Q.T.CAP NY.LT.GREEN	1.30
			CP25599-6-NY	Q.T.CAP NY.LT.YELL.	1.30



PART NO.	DESCRIPTION	U.S.DOLLARS	PART NO.	DESCRIPTION	U.S.DOLLARS
CP25599-7-NY	Q.T.CAP NY.LT.BROWN	1.30	CP2815-SS	3/4 PIPE PLUG,ST.STL	40.54
CP25599-8-NY	Q.T.CAP NY.LT.ORANG	1.30	CP2930-100-SS	#100 MESH TEEJET STR. SCREEN,SS	1.46
CP25607-9-PP	QT CAP,POLYPRO,GRAY	1.43	CP2930-110-SS	TEEJET STR.SCREEN,SS	1.46
CP25609-1-NY	Q.T.CAP NY.LT.BLACK	1.30	CP2930-200-SS	#200 MESH TEEJET STR. SCREEN,SS	1.46
CP25609-2-NY	Q.T.CAP NY.LT.WHITE	1.30	CP2930-24-SS	#24 MESH TEEJET STR.SCREEN,SS	1.46
CP25609-3-NY	Q.T.CAP NY.LT.RED	1.30	CP2930-50-SS	#50 MESH TEEJET STR.SCREEN,SS	1.46
CP25609-4-NY	Q.T.CAP NY.LT.BLUE	1.30	CP2930-80-SS	#80 MESH TEEJET STR.SCREEN,SS	1.46
CP25609-5-NY	Q.T.CAP NY.LT.GREEN	1.30	CP3261	AIR STR.SUPPORT,BRSS	3.12
CP25609-6-NY	Q.T.CAP NY.LT.YELL.	1.30	CP3598	BODY,BRASS,1/8AB	16.63
CP25609-7-NY	Q.T.CAP NY.LT.BROWN	1.30	CP3598-AL	BODY,ALUM,1/8ABAL	16.63
CP25609-8-NY	Q.T.CAP NY.LT.ORANG	1.30	CP3599	CAP,BRASS,1/8AB	15.63
CP25611-9-PP	QT CAP,POLYPRO,GRAY	1.43	CP3599-AL	CAP,ALUM.,1/8ABAL	15.63
CP25614-SS	CONNECTOR, 303SS	22.45	CP3609	TEEJET STR.BODY,BRASS. F/5053	4.81
CP25661-NYB	BODY NYLON-BL.25660	100.50	CP3610	TEEJET STRAINER CAP,BRASS F/5053	2.78
CP25662-NYB	COVER NYLON-BL.25660	35.91	CP36101-EPR	DIAPHRAGM, EPDM	10.95
CP25664-PP	SEATING INS.POLY-PRO	2.41	CP36101-VI	DIAPHRAGM,VITON	24.63
CP25670-1.5-NY	NOZZLE NYLON 25660	20.85	CP3621-5-SS	SPRING,ST.STL.,1/4BB	3.26
CP25670-3.0-NYB	NOZZLE NYLON 25660	20.85	CP36283	BODY, BRASS	47.30
CP25670-4.0-NY	NOZZLE NYLON 25660	20.85	CP36284	RING, BRASS (1/2 X 1/2 LOCK RING ADJ.JOINT)	35.21
CP25671-302SS	SPRING 302SS,25660	7.04	CP36285	BALL, BRASS	32.50
CP25672-NY	TRIGGER LOCK,25660	14.04	CP36301-NY	HANDLE,NYLON	8.47
CP25673-NY	TRIGGER POLY-PRO.	16.07	CP36302-PP	BODY INSERT,PP	7.63
CP25674-302SS	SPRING 302SS,25660	4.35	CP36303-PP	BODY,PP	24.78
CP25676-IZP	#8 PLASTITE SCREW	1.67	CP36304-SS	VALVE STEM 303SS F/ 6B DIRECTOVALVE	9.01
CP25678	SEAT WASHER RETAINER	3.83	CP36306-302SS	SPRING,302SS,#6B	5.03
CP25678-SS	SEAT WASHER RETAINER	10.06	CP36307-PPB	WASHER,POLYPRO,BLACK	2.81
CP2570-10-FC	GASKET,FIBER,-TW	4.87	CP36308-SS	GROOVE PIN,303SS	1.93
CP2570-6-FC	GASKET,FIBER,-TW	3.90	CP36309-302SS	RETAINING CLIP,302SS	4.85
CP2570-7-FC	GASKET,FIBER,-TW	3.90	CP36311-SS	TEEJET BODY.ST.STL.	24.72
CP2570-8-FC	GASKET,FIBER,-TW	3.52	CP3646	BODY,BRASS,1/4AB	20.31
CP2570-9-FC	GASKET,FIBER,-TW	4.50	CP3646-AL	BODY,ALUM.,1/4ABAL	20.31
CP25713-1/2-NYB	1/2X1/4M LOWER CLAMP	8.47	CP3646-SS	BODY,ST.STL.,1/4ABSS	49.31
CP25714-3/4-NYB	3/4X1/4M LOWER CLAMP	8.47	CP3647	CAP,BRASS,1/4AB	18.25
CP25776-1/2-NYB	1/2 BODY NYLON	6.57	CP3647-AL	CAP, ALUM.,1/4ABAL	18.25
CP25777-3/4-NYB	3/4 BODY NYLON	6.57	CP3647-SS	CAP, ST.STL.,1/4ABSS	39.14
CP25831-302SS	SPRING 302SS RED	19.21	CP3648-10-302SS	SPRING,302SS,1/4AB	5.95
CP26110-POLYFP	NOZZLE PROTECTOR	3.43	CP3648-125-302SS	SPRING,302SS,1/4AB	5.95
CP2615	UNION NUT,BRASS	4.96	CP3648-20-302SS	SPRING,302SS,1/4AB	5.95
CP26197-7/8-SS	SCREW SOCKET HD CAP	3.49	CP3648-250-302SS	SPRING,302SS,1/4AB	5.95
CP26227-EPR	SEAL EPDM RUBBER	1.89	CP3648-30-302SS	SPRING,302SS,1/4AB	5.95
CP26250-1-SS	BALL VALVE STEM, SS	40.52	CP3648-40-302SS	SPRING,302SS,1/4AB	5.95
CP26250-NY	AA344AE-2RB ONLY	5.86	CP3648-5-302SS	SPRING,302SS,1/4AB	5.95
CP26251-NY	344M STEM, NYLON	5.86	CP3650-2.55-56	TIP BODY,BRASS,TN-	4.24
CP26251-PP	344M STEM, PP	7.65	CP3651	CORE HOLDER,BRASS	7.27
CP2627	BODY,BRASS,1/4BB	20.63	CP36540-1-NY	QT CAP NYLON / BLACK	1.30
CP26277-1-NY	QT CAP NYLON, BLACK	1.30	CP36540-3-NY	QT CAP NYLON / RED	1.30
CP26277-3-NY	QT CAP NYLON, RED	1.30	CP36540-4-NY	QT CAP NYLON / BLUE	1.30
CP26484	INLET CYLINDER,1/4M	39.07	CP36540-5-NY	QT CAP NYLON / GREEN	1.30
CP26486-SS	SPRING WASHER,ST.STL	2.97	CP36540-6-NY	QT CAP NYLON/YELLOW	1.30
CP26487-SS	SPACER, 303SS	9.38	CP36540-9-NY	QT CAP NYLON / GREY	1.30
CP2811	1/8 PIPE PLUG,BRASS	5.11	CP3655-10-SS	SPRING,ST.STL.,1/8AB	5.95
CP2812	1/4 PIPE PLUG,BRASS	5.37	CP3655-2-SS	SPRING,ST.STL.,1/8AB	5.95
CP2812-AL	1/4 PIPE PLUG,ALUM.	5.17	CP3655-20-SS	SPRING,ST.STL.,1/8AB	5.95
CP2812-IZP	1/4 PIPE PLUG,STL,PL	8.01	CP3655-5-SS	SPRING,ST.STL.,1/8AB	5.95
CP2812-SS	1/4 PIPE PLUG,ST.STL	12.28	CP37144-IP	COIL STRAP,IRON PNTD	37.99
CP2813	3/8 PIPE PLUG,BRASS	7.27	CP37152-1-NYB	LOWER DIA. HOLDER	22.01
CP2813-SS	3/8 PIPE PLUG,ST.STL	17.32	CP37152-NYB	LOWER DIAPHR.HOUSING	22.01
CP2814	1/2 PIPE PLUG,BRASS	11.35	CP37154-NYB	LOWER DIAPHRAGM CAP	13.58
CP2814-AL	1/2 PIPE PLG,ALUM.	7.06	CP37156-PP	1"STRAIGHT HOSE BARB	12.67
CP2814-ALEF	1/2 PIPE PLUG,ALEF	11.38			
CP2814-ICP	1/2 PIPE PLUG,CAST IRON,STL,PL	11.34			
CP2815	3/4 PIPE PLUG,BRASS	15.06			
CP2815-ALEF	3/4 PIPE PLG,ALUM.EF	17.42			
CP2815-IZP	3/4 PIPE PLUG STL-PL	14.50			

PART NO.	DESCRIPTION	U.S.DOLLARS	PART NO.	DESCRIPTION	U.S.DOLLARS
CP37159-PP	INNER CONNECTOR POLYPRO	13.76	CP38948-NYB	3/4HX1/2T HOSE SHANK	4.24
CP37164-SS	STEM 303SS	44.43	CP38949-NY	E CLIP	2.80
CP37166-1-302SS	RETAINING CLIP,302SS	3.58	CP3910-11-M	SCREEN, MONEL,20M,HSW	38.65
CP37271-PP	BOWL, POLYPRO, #37270 .690	49.96	CP3910-12-M	SCREEN, MONEL,30M,HSW	38.65
CP37273-NYB	BOTTOM ADAPTER BLACK NYLON	52.92	CP3910-13-M	SCREEN, MONEL,50M,HSW	38.65
CP37385-PP	3 WAY FEMALE CONNECT	1.82	CP3910-14-M	SCREEN, MONEL,80M,HSW	38.65
CP37386-PP	3 WAY MALE CONNECTOR	2.14	CP3910-15-M	SCREEN, MONEL,100M,HSW	38.65
CP37387-1-COMMAT	MALE TERM./NO STABIL	2.14	CP3910-2-M	SCREEN, MONEL,200M,HSW	38.65
CP37548-PP	1" THREADED INLET POLYPRO	12.67	CP3928	STRAINR BDY,BR,1/8VV	5.11
CP37553-25-SS	M6X1X25M SCREW	1.79	CP3928-SS	STRAINR BDY,SS,1/8VV	11.72
CP37558-PP	INLET BLANK,POLYPRO	12.67	CP3929-100-SS	SCREEN,100M,SS,1/8VV	3.86
CP37684-PP	1/4 TREADED INLET	12.67	CP3929-200-SS	SCREEN 200M,SS,1/8VV	3.86
CP37687-PP	3/8 TREADED INLET	12.67	CP3929-50-SS	SCREEN,50M,SS,1/8VV	3.86
CP37752-2-DEL	BOTTOM HSG,1/4NPT	57.74	CP39321-SS	FLAT WASHER	5.76
CP3791	STRAINER BODY,BRASS	5.49	CP39334-VI	GASKET, 70 DURO, VITON	1.59
CP3791-SS	STRAINER BODY,ST.STL	12.68	CP3942	BLK PLUG TIP,BR,1/4T	0.71
CP37926-SS	ADJUSTING ARM,301SS	22.65	CP3942-AL	BLK PLUG TIP,AL-1/4T	0.71
CP38023-POL	FILL BOTTLE,POLYETHY	9.16	CP3942-HDP	BLK PLUG TIP,HDP,1/4T	0.47
CP38024-NY	REDUCER,NYLON	4.11	CP3942-SS	BLK PLUG TIP,SS,1/4T	1.04
CP38072-IENP	ARMATURE, IRON-ENP	31.79	CP39536-NYB	BODY NYLON BLACK	25.29
CP38073-IENP	ARMATURE STOP,IRON	17.28	CP39537-1-CE	1/8" CAP 39535	21.14
CP38074-NYB	UPPER DIAPH.HOUSING	25.05	CP39540-302SS	SPRING 302SS	8.23
CP38075-NYB	LOWER DIAPH.HOUSING	44.77	CP39541-302SS	SPRING, 302SS	8.23
CP38076-302SS	SPRING,SS	9.85	CP39581-NYB	BODY	54.46
CP3817	TEEJET BODY,BR,3/4T	27.54	CP39583-1-SS	STUD	36.18
CP3817-SS	TEEJET BODY,SS,3/4T	78.67	CP39583-2-SS	STUD	38.15
CP3818	TEEJET BODY,BR,3/4TT	27.54	CP39583-3-SS	STUD	40.18
CP3818-SS	TEEJET BODY,SS,3/4TT	78.67	CP39583-4-SS	STUD	40.37
CP3819	TEEJET CAP,BR,3/4T	16.05	CP39583-5-SS	STUD	40.46
CP3819-SS	TEEJET CAP,SS,3/4T	45.47	CP39583-6-SS	STUD	44.24
CP3820-100-SS	SCREEN,100MESH,SS.	4.11	CP39584-PP	1 1/4 HOSE BARB	12.67
CP3820-20-SS	SCREEN,20MESH.ST.STL	4.11	CP39689	NUT	3.76
CP3820-200-SS	SCREEN,200MESH,SS.	4.11	CP39698-NY	CAM LOCK 4/23 GUN NY	15.18
CP3820-50-SS	SCREEN,50MESH,ST.STL	4.11	CP39769-PP	ALIGNMENT INSERT BLACK POLYPRO F/MANIFOLD	2.63
CP38435-1/4-SSNY	ELASTIC LOCKNUT	4.54	CP4066	LOCK.SCREW,BR,EYELET	2.30
CP38435-M8-SSNY	LOCKNUT	4.54	CP4066-416SS	LOCK SCREW,416SS	7.01
CP38441-1-SS	RL BALL, SS	105.19	CP4066-ALEF	LCK.SCRW,ALEF,EYELET	5.96
CP38441-SS	SS BALL	105.19	CP4131-1/4PT	BODY,BRASS,1/4PT	21.18
CP38442-SS	BALL VALVE STEM 303SS	40.52	CP4131-500T	BODY,BRASS,500T	8.89
CP38659-I	MOUNTING BRACKET	12.02	CP4141	CAP NUT,BRASS,4202	6.73
CP38721-12-PP	ORIFICE INSERT BROWN	7.57	CP4142	CONN.SCREW,BR.4202-	7.64
CP38721-18-PP	ORIFICE INSERT, ORNG	7.57	CP4143-CU	GASKET,COPPER, 5000	2.37
CP38721-8-PP	ORIFICE INSERT GREY	7.57	CP4144	NOZZLE BODY,BR,4202-	11.14
CP38722-1-PP	CORE, PP BLACK	7.20	CP4145-1	INLET BODY,BR,4202-	10.96
CP38722-2-PP	CORE, PP ORANGE	7.20	CP4145-2	INLET BODY,BR.4202-	10.96
CP38725-SS	MACHINE SCREW,SS	2.92	CP4150-625T	BODY,BRASS,625T	42.17
CP38726-VI	GASKET,VITON	10.83	CP4174	NOZZLE BODY,BR.4183A	9.60
CP38921-2-NYB	363C TURRET	6.75	CP4175-BU	GASKET,BUNA-N,4183A-	2.37
CP38922-2-NYB	364C TURRET	7.25	CP4189	CONN.SCREW,BR.4183A-	4.84
CP38923-2-NYB	365C TURRET	7.71	CP4190-BU	GASKET, BUNA-N,EYELET	2.37
CP38924-2-NYB	20MM 360E BODY	7.43	CP4190-VI	GASKET,VITON ,EYELET	7.08
CP38925-2-NYB	3/4"360C BODY NYLON	7.43	CP4214	BODY, BRASS, 500TLW	8.01
CP38926-2-NYB	1" 360C BODY NYLON	7.43	CP4215-1	CONN.BODY,BRASS.4203	8.20
CP38930-7-NYB	STD PLUG FOR QJ360E	2.26	CP4215-2	CONN.BODY,BRASS.4203	8.20
CP38930-8-NYB	STD PLUG FOR QJ360C	2.26	CP4216-CU	GASKET,COPPER,4183A	2.30
CP38931-NYB	E CLIP	2.26	CP4235	LOCKING SCREW,BRASS	2.30
CP38936-NYB	500 SINGLE SHANK	3.57	CP4241	BOOMJET BODY,BRASS	190.39
CP38937-NYB	500 DOUBLE SHANK	4.24	CP4242	NOZZLE BODY,BR.4298-	35.26
CP38938-NYB	750 SINGLE SHANK	3.57	CP4243	CONN.SCREW,BRASS	28.90
CP38939-NYB	750 DOUBLE SHANK	4.24	CP4244	CAP NUT,BR,BOOMJET	14.01
CP38940-NYB	1000 SINGLE SHANK	3.57	CP4245-AL	GASKET,ALUMINUM	6.36
CP38941-NYB	1000 DOUBLE SHANK	4.24	CP4245-CU	GASKET,COPPER	6.36
CP38942-2-NYB	1/2" BODY FOR 360C	7.43	CP4246-CU	SCREW GASKET,COPPER	6.69

PART NO.	DESCRIPTION	U.S.DOLLARS	PART NO.	DESCRIPTION	U.S.DOLLARS
CP4246-CUENP	GASKET,CU-ELECT.NP	7.79	CP45541-NYB	3 WAY HOUSING	58.69
CP4249-1/4/500	BODY,BRASS,1/4-500	13.97	CP45542-SS	SOCKET HD CAP SCREW	6.08
CP4289-1/4/625	BODY,BRASS,1/4-625	13.44	CP45544-1-VL	STICKER F/46250-6	6.15
CP4325-100-SS	TEEJET ST.SCREEN,SS	2.26	CP45632	144P COIL SUB ASB	216.54
CP4325-50-SS	TEEJET STR.SCREEN,SS	2.26	CP45634-430FRS	ARMATURE, 144P	53.62
CP4387	OUTLET BODY,BRASS	9.16	CP45637-302SS	SPRING, 144P	8.21
CP4412	BODY BRASS, 8579-	21.38	CP4578	CAP,BRASS	8.24
CP4420	SCREW,BRASS,BOOMJET	29.74	CP4579	DISC HOLDER,BR,4817	5.28
CP45101-1/2-PP	1/2" NPT 122ML STRAINER HEAD, PP	13.30	CP4581-INP	TRIGGER,STEEL-PLATED	7.06
CP45101-3/4-PP	3/4" NPT 122ML STRAINER HEAD, PP	13.30	CP4582-INP	TRIGGER STOP,STL-PLT	4.81
CP45102-3-SSPP	(-3) 50 MESH SCREEN,SSPP. GENTIAN BLUE	10.22	CP4585-302SS	TRIG.STP SPRNG,302SS	2.30
CP45102-4-SSPP	(-4) 80 MESH SCREEN, SSPP.ZINC YELLOW	10.22	CP4586-SS	VALVE SPRING,ST.STL.	3.44
CP45102-5-SSPP	(-5) 100 MESH SCREEN,SSPP, TRAFFIC GREEN	10.22	CP4587-BU	DISC,BUNA-N	5.28
CP45195-NYB	GASKET	2.37	CP4587-TEF	VALVE DISC,TEFLON	12.00
CP45196-NYB	GASKET	2.37	CP4587-VI	DISC,VITON	12.77
CP45197-NYB	GASKET	2.37	CP4588-SS	VALVE STEM,SS,4817	7.49
CP45198-NYB	TUBING GASKET, #2 #2A GUNJETS, NYB	2.37	CP4590	SWIVL RING,BR,3/4TOC	9.27
CP45204-5/8-SS	THREAD FORMING SCREW	1.41	CP4590-AL	SWIVL RING,AL,3/4TOC	9.51
CP45207-PP	#75X50 REDUCER, PP	20.43	CP4591	SCREW,BR,3/4T SWIVEL	24.47
CP45216-AL	MOUNTING BAR, AL	7.95	CP4591-AL	SCREW,AL,3/4T SWIVEL	25.16
CP45251-PP	TEE BODY	29.54	CP45937-1-1/4-SS	SOCKET HEAD	3.30
CP45252-2-3/4-SSPV	SCREW	11.20	CP45938-CE	PLUNGER CELCON	35.77
CP45253-NYB	OUT.FLANGE END CAP	30.16	CP4596	RETAINR,BR,5700 MULT	12.67
CP45256-IZP	MOUNTING BRACKET	22.68	CP4600	TIP,BRASS,5700 MULTJ	27.88
CP45259-SS	M6-1.0X16MM SCREW	1.44	CP46023-NYB	ORIFICE DISK	29.73
CP45335-4-NY	VH CONNECTOR	2.63	CP46026-NYB	PLUNGER	56.84
CP45446-1-NYB	460 3FB HOUSING	64.42	CP46029-PP	#50 MALE QC	7.32
CP45446-NYB	460 3E HOUSING	133.12	CP46061-PP	BODY, 480 MANIFOLD	35.38
CP45502-NYB	BALL SEAL SPACER	3.40	CP46064-PP	OUTLET FLANGE,480	21.81
CP45503-NYB	460 BODY SUB/ASBLY	46.11	CP46066-PP	1-1/2 NPT OUTLET,480	9.53
CP45504-PP	#50X1 HOSE BARB, PP	2.98	CP46067-PP	#75X1-1/2 HOSE BARB	7.89
CP45505-PP	#50X1-1/4 HOSE BARB	2.98	CP46069-PP	#75 INLET COVER	7.89
CP45506-PP	#50X1-1/2 HOSE BARB	3.35	CP46071	MOUNTING BRACKET	24.64
CP45507-PP	#50 INLET COVER	3.44	CP46073-110-302SS	#M8X1.25X110MM SCREW	5.00
CP45508-1/4-PP	#50X1/4 IN PTF	3.84	CP46073-120-302SS	#M8X1.25X120MM SCREW	4.36
CP45510-1-SS	2 & 3 WAY BALL SS	99.52	CP46073-2--302SS	M8X1.25X20 SCREW	4.36
CP45510-3-SS	FLOWBACK BALL SS	128.02	CP46073-25-302SS	#M8X1.25X25M SCREW	2.03
CP45512-PP	#50X1-1/4	3.84	CP46074-302SS	M8X1.25 HEX NUT	1.17
CP45513-NYB	1 QC HOSE BARB	7.78	CP46078-302SS	M8 METRIC WASHER	0.54
CP45514-NYB	QC END CAP,460Z	30.16	CP46079-SS	SS BALL	430.52
CP45517-1-1/8-SS	THREAD FORMING SCREW	3.42	CP46127-1/4-PP	INLET, 480	9.53
CP45518-NYB	REAR COVER, 460Z	26.89	CP46127-3/8-PP	INLET, 480	9.53
CP45520-SS	M6 LOCK WASHER,18-8-SS	1.32	CP46145-1/4-NY	1/4 QUICK TEEJET CAP F/QJ4676, NY BLACK	2.91
CP45521-NYB	3/4 QC HOSE BARB	7.78	CP46145-1/8-NY	1/8 QUICK TEEJET CAP F/QJ4676, NY BLACK	2.91
CP45522-NYB	1/2 QC HOSE BARB	7.78	CP4620-1-VI	DIAPHRAGM, VITON	2.30
CP45523-NYB	1X90 QC HOSE BARB	7.78	CP4620-FA	DIAPHRAGM, FA	0.73
CP45524-NYB	3/4X90 QC HOSE BARB	7.78	CP4620-VI	DIAPHRAGM,VITON	2.30
CP45525-NYB	1/2X90 QC HOSE BARB	7.78	CP4621	SPRING RETAINER,BRASS	5.67
CP45526-NYB	1"(M) QC ADPTR	8.50	CP4621-AL	SPRING RETAINER, AL	5.67
CP45527-NYB	3/4 (M) QC QUICK CON	8.50	CP4622-1-302SS	SPRING,302SS,DI.TEJT	2.79
CP45530-NYB	5/8X90 QC HOSE BARB	7.78	CP4622-11-302SS	SPRING,302SS DI TEJT	2.79
CP45531-NYB	3 WAY UPPER CLAMP	18.92	CP4622-15-302SS	HI.PRES.SPR,DIA.TEJT	2.79
CP45532-NYB	3 WAY LOWER CLAMP	18.92	CP4622-25-302SS	SPRING DIAPH.TEEJET	2.79
CP45534-NYB	ADJ DISK	85.02	CP4622-40-302SS	HI.PRES.SPR.DIA.TEJT	18.30
CP45535-1-NYB	460Z-3C ORFICE DISK	59.69	CP4622-5-302SS	SPRING DIAPH.TEEJET	2.79
CP45536-302SS	SPRING	9.22	CP4622-7-302SS	STAND,SPR.DIAPH.TEJT	2.79
CP45537-SS	SET SCREW	16.76	CP4622-8-302SS	SPRING DIAPH.TEEJET	2.79
CP45538-NYB	KNOB	5.46	CP4623	END CAP,BRASS,DIA.TEEJT	8.25
CP45539-3/8-PP	#50X3/8 IN PTF	3.84	CP4623-AL	END CAP,AL,DI.TEEJET	8.25
			CP4624	RETAINR,BRASS,DIA.TEEJT	4.24
			CP4624-ALEF	RETAINR,AL-EF,D.TEJT	4.24
			CP4633-1-SS	SCREEN, ST.STL. 16M	22.25

PART NO.	DESCRIPTION	U.S.DOLLARS	PART NO.	DESCRIPTION	U.S.DOLLARS
CP4633-2-SS	SCREEN, ST.STL. 24M	22.25	CP48497-NYB	20MM Q.T.BODY/CLAMP	7.20
CP4633-4-SS	SCREEN, ST.STL. 50M	22.25	CP48498-NYB	3/4" Q.T.BODY W/CLAMP	7.20
CP4633-6-SS	SCREEN ST.STL.100M	22.25	CP48499-NYB	1" Q.T. BODY W/CLAMP, BLACK NYLON	7.20
CP4634-BU	GASKET,BUNA-N,STRAINER	5.04	CP48570-NY	GAUGE CONN ELBOW	10.06
CP4636	RETAINER,BR,3/4Q	12.39	CP48575-17-NYB	17 FT TUBING	52.05
CP4637-SS	SNAP RING,SS,3/4Q	7.84	CP48645-12-SS	SCREW	5.82
CP4662-BU	GASKET,BUNA-N,-HSW	2.92	CP48654-1-PP	BOWL POLYPRO	36.54
CP46716-PP	#75X75 TEE POLYPRO	20.91	CP48654-PP	LARGE BOWL GRAY-PP-NPT	36.54
CP46717-PP	#75X50 TEE POLYPRO	19.60	CP48655-PP	CAP PP GRAY	6.53
CP4682	TRIGER TEEJET BDY,BR	56.72	CP48656-EPR	126 HD GASKET -5,-6	6.72
CP4682-1	TRIGER TEEJET BDY,BR	56.72	CP48656-VI	126 HD GASKET , VITON 5,-6	13.98
CP4682-3	TRIGER TEEJET BDY,BR	56.72	CP4873	STEM SLEEVE,BR,4817	2.79
CP4689-2-SS	SCREEN, ST. STL, 24M	19.46	CP48792-302SS	60# SPRING F/23120A	11.93
CP4689-4-SS	SCREEN, ST. STL. 50M	19.46	CP4916-006	ORIFICE PLATE,ST.STL	4.72
CP4689-6-SS	SCREEN, ST.STL. 100M	19.46	CP4916-007	ORIFICE PLATE,ST.STL	4.72
CP4721	INLET BODY,BRSS,4720	6.60	CP4916-008	ORIFICE PLATE,ST.STL	4.72
CP4723	BALL,BRASS, 4720	5.11	CP4916-10	ORIFICE PLATE,ST.STL	4.72
CP4727-1-R	HANDLE COVER,RUBBER	3.95	CP4916-103	ORIFICE PLATE,ST.STL	4.72
CP4727-2	INLET CONNECTION,BR.	13.66	CP4916-107	ORIFICE PLATE,ST.STL	4.72
CP4729-SS	FERRULE,SS,EXTENSION	13.58	CP4916-110	ORIFICE PLATE,ST.STL	4.72
CP4743-NY	GASKET,NYLON,CLEAR	2.36	CP4916-115	ORIFICE PLATE,ST.STL	4.72
CP4743-TEF	TEEJET GASKET,TEFLON	8.25	CP4916-12	ORIFICE PLATE,ST.STL	4.72
CP4755	INLET CONN.TUBE,BR.	18.67	CP4916-120	ORIFICE PLATE,ST.STL	4.72
CP4757	CONNECTING NUT, BR	8.70	CP4916-125	ORIFICE PLATE,ST.STL	4.72
CP4784-AL	TEEJET GASKT,AL,3/4T	2.37	CP4916-128	ORIFICE PLATE,ST.STL	4.72
CP4784-CU	TEEJET GASKT,COPPER	2.37	CP4916-132	ORIFICE PLATE,ST.STL	4.72
CP4814	BODY,BRASS,4765 VLVE	37.84	CP4916-136	ORIFICE PLATE,ST.STL	4.72
CP4815-1/250	OUTLET CONN,4765-GGH	31.42	CP4916-14	ORIFICE PLATE,ST.STL	4.72
CP4815-1/500	OUTLET CONN,4765-GGH	31.42	CP4916-140	ORIFICE PLATE,ST.STL	4.72
CP4815-250	OUTLET CONN,4765-250	18.49	CP4916-144	ORIFICE PLATE,ST.STL	4.72
CP4815-500	OUTLET CONN,4765-500	18.49	CP4916-147	ORIFICE PLATE,ST.STL	4.72
CP48150-PP	#50X3/4 HOSE BARB	2.98	CP4916-15	ORIFICE PLATE,ST.STL	4.72
CP48151-PP	#50X90X3/4 HOSE BARB, PP	3.66	CP4916-151	ORIFICE PLATE,ST.STL	4.72
CP48152-PP	#50X90X1 HOSE BARB, PP	3.66	CP4916-156	ORIFICE PLATE,ST.STL	4.72
CP48154-PP	#50X1 PTF	3.44	CP4916-16	ORIFICE PLATE,ST.STL	4.72
CP48155-PP	#50X1 IN PTM	3.44	CP4916-161	ORIFICE PLATE,ST.STL	4.72
CP48156-PP	#50X1-1/2 THR PTM	3.71	CP4916-166	ORIFICE PLATE,ST.STL	4.72
CP48157-PP	#50 STRAIGHT COUPLNG	7.32	CP4916-170	ORIFICE PLATE,ST.STL	4.72
CP48158-PP	#50 ELBOW COUPLING	9.75	CP4916-171	ORIFICE PLATE,ST.STL	4.72
CP48159-PP	50X3/4" FEMALE THREADED FITTING	3.44	CP4916-172	ORIFICE PLATE,ST.STL	4.72
CP4816	INLET CONN.,BR,4765-	23.54	CP4916-177	ORIFICE PLATE,ST.STL	4.72
CP48160-PP	#75X1-1/4 HOSE BARB	7.89	CP4916-18	ORIFICE PLATE,ST.STL	4.72
CP48161-PP	#75X2 HOSE BARB	7.89	CP4916-182	ORIFICE PLATE,ST.STL	4.72
CP48162-PP	75X90X1-1/4 HOSEBARB	13.35	CP4916-187	ORIFICE PLATE,ST.STL	4.72
CP48163-PP	75X90X1-1/2 HOSEBARB	13.35	CP4916-196	ORIFICE PLATE,ST.STL	4.72
CP48164-PP	75X90X2 HOSE BARB	13.35	CP4916-20	ORIFICE PLATE,ST.STL	4.72
CP48165-PP	#75X1-1/4 IN PTM	6.99	CP4916-205	ORIFICE PLATE,ST.STL	4.72
CP48166-PP	#75X1-1/2 IN PTM	6.99	CP4916-218	ORIFICE PLATE,ST.STL	4.72
CP48167-PP	#75X2 IN PTM	6.99	CP4916-22	ORIFICE PLATE,ST.STL	4.72
CP48168-PP	#75 ELBOW COUPLING	18.27	CP4916-23	ORIFICE PLATE,ST.STL	4.72
CP48169-PP	#75 STRAIGHT COUPLNG	20.43	CP4916-234	ORIFICE PLATE,ST.STL	4.72
CP48172-PP	#50X3/4 IN PTM	3.44	CP4916-24	ORIFICE PLATE,ST.STL	4.72
CP4821-302SS	SNAP RING, SS	2.37	CP4916-25	ORIFICE PLATE,ST.STL	4.72
CP48220-NYB	20MM UPPER CLAMP	2.63	CP4916-250	ORIFICE PLATE,ST.STL	4.72
CP48221-NYB	3/4" UPPER CLAMP	2.63	CP4916-26	ORIFICE PLATE,ST.STL	4.72
CP48222-NYB	1" UPPER CLAMP	2.63	CP4916-27	ORIFICE PLATE,ST.STL	4.72
CP48223-NYB	1/2" UPPER CLAMP	2.63	CP4916-28	ORIFICE PLATE,ST.STL	4.72
CP48224-NYB	25MM UPPER CLAMP	2.63	CP4916-29	ORIFICE PLATE,ST.STL	4.72
CP48255-1-1/4-302SS	13-16X1-1/4 SCREW	4.96	CP4916-30	ORIFICE PLATE,ST.STL	4.72
CP48256-SS	PIVOT PIN, 303SS	1.40	CP4916-31	ORIFICE PLATE,ST.STL	4.72
CP48261-NYB	BODY FOR QJ360	7.43	CP4916-32	ORIFICE PLATE,ST.STL	4.72
CP48265-NYB	#50 FLANGED END CAP	28.70	CP4916-34	ORIFICE PLATE,ST.STL	4.72
CP48496-NYB	1/2" Q.T.BODY W/CLAMP	7.20	CP4916-35	ORIFICE PLATE,ST.STL	4.72

PART NO.	DESCRIPTION	U.S.DOLLARS	PART NO.	DESCRIPTION	U.S.DOLLARS
CP4916-36	ORIFICE PLATE,ST.STL	4.72	CP50491-PP	FLANGE 50 STR HEAD	18.10
CP4916-37	ORIFICE PLATE,ST.STL	4.72	CP50492-1-PP	1" NPT STRAINER HEAD, PP	18.10
CP4916-39	ORIFICE PLATE,ST.STL	4.72	CP50492-3/4-PP	3/4" NPT STRAINER HEAD, PP	18.10
CP4916-40	ORIFICE PLATE,ST.STL	4.72	CP50493-1-PP	BOWL, AA126 SC, POLYPRO SELF CLEAN BOWL	17.86
CP4916-41	ORIFICE PLATE,ST.STL	4.72	CP50493-PP	MEDIUM STRAINER BOWL GRAY-PP NPT	17.86
CP4916-43	ORIFICE PLATE,ST.STL	4.72	CP50494-EPR	126 HEAD GSK 3/4,1"	3.34
CP4916-45	ORIFICE PLATE,ST.STL	4.72	CP50494-VI	126 HEAD VITON GSK 3/4" & 1"	8.43
CP4916-46	ORIFICE PLATE,ST.STL	4.72	CP50501-PP	356 BODY, POLYPRO	15.10
CP4916-47	ORIFICE PLATE,ST.STL	4.72	CP50502-PP	END CAP FOR 356,PP	9.53
CP4916-48	ORIFICE PLATE,ST.STL	4.72	CP50503-CTEF	356 BALL SEAL	19.44
CP4916-49	ORIFICE PLATE,ST.STL	4.72	CP50504-VI	356 GASKET, VITON	15.26
CP4916-51	ORIFICE PLATE,ST.STL	4.72	CP50505-RYTON	STEM BUSHING, 356	6.65
CP4916-52	ORIFICE PLATE,ST.STL	4.72	CP50506-316SS	356 BALL, 316SS	113.33
CP4916-54	ORIFICE PLATE,ST.STL	4.72	CP50507-304SS	MOUNTING PLATE	7.18
CP4916-55	ORIFICE PLATE,ST.STL	4.72	CP50509-CTEF	356 LOWER BUSHING	6.95
CP4916-57	ORIFICE PLATE,ST.STL	4.72	CP50514-PP	356 MOTOR ADAPTER POLYPRO	5.95
CP4916-59	ORIFICE PLATE,ST.STL	4.72	CP50517-SSPV	CLIP SSPV,356 VLV	4.44
CP4916-61	ORIFICE PLATE,ST.STL	4.72	CP50532-316SS	356 STEM, 316SS	76.90
CP4916-63	ORIFICE PLATE,ST.STL	4.72	CP50676-1-VI	CUP SEAL FOR ACS	4.44
CP4916-65	ORIFICE PLATE,ST.STL	4.72	CP50676-VI	CUP SEAL FOR ACS	4.44
CP4916-67	ORIFICE PLATE,ST.STL	4.72	CP50786-PP-300	300 INLET FOR 50800	3.79
CP4916-68	ORIFICE PLATE,ST.STL	4.72	CP50786-PP-406	406 INLET FOR 50800	3.79
CP4916-70	ORIFICE PLATE,ST.STL	4.72	CP5218-TEF	GASKET TEFLON,105-	5.28
CP4916-72	ORIFICE PLATE,ST.STL	4.72	CP5275-SS	TEEJET STR.BODY,SS	16.26
CP4916-73	ORIFICE PLATE,ST.STL	4.72	CP5341-10W	ORIFICE INSERT,BRASS	8.03
CP4916-75	ORIFICE PLATE,ST.STL	4.72	CP5341-10W-SS	ORIF.INSERT,ST.STL.	13.51
CP4916-78	ORIFICE PLATE,ST.STL	4.72	CP5341-12W	ORIFICE INSERT,BRASS	8.03
CP4916-80	ORIFICE PLATE,ST.STL	4.72	CP5341-12W-SS	ORIF.INSERT,ST.STL.	13.51
CP4916-81	ORIFICE PLATE,ST.STL	4.72	CP5341-2W	ORIFICE INSERT,BRASS	8.03
CP4916-83	ORIFICE PLATE,ST.STL	4.72	CP5341-2W-SS	ORIF.INSERT,ST.STL.	13.51
CP4916-86	ORIFICE PLATE,ST.STL	4.72	CP5341-3W	ORIFICE INSERT,BRASS	8.03
CP4916-89	ORIFICE PLATE,ST.STL	4.72	CP5341-3W-SS	ORIF.INSERT,ST.STL.	13.51
CP4916-90	ORIFICE PLATE,ST.STL	4.72	CP5341-4W	ORIFICE INSERT,BRASS	8.03
CP4916-91	ORIFICE PLATE,ST.STL	4.72	CP5341-4W-SS	ORIF.INSERT,ST.STL.	13.51
CP4916-93	ORIFICE PLATE,ST.STL	4.72	CP5341-5W	ORIFICE INSERT,BRASS	8.03
CP4916-95	ORIFICE PLATE,ST.STL	4.72	CP5341-5W-SS	ORIF.INSERT,ST.STL.	13.51
CP4916-96	ORIFICE PLATE,ST.STL	4.72	CP5341-6W	ORIFICE INSERT,BRASS	8.03
CP4916-98	ORIFICE PLATE,ST.STL	4.72	CP5341-6W-SS	ORIF.INSERT,ST.STL.	13.51
CP4928	ADAPTER,BRASS,4908	29.00	CP5341-8W	ORIFICE INSERT,BRASS	8.03
CP4928-SS	ADAPTER,ST.STL,4908	52.68	CP5341-8W-SS	ORIF.INSERT,ST.STL.	13.51
CP4931	SWIV.RETAINER,BR,EXT	11.35	CP5341-X.50	ORIFICE INSERT,BRASS	8.03
CP4932	GUIDE SLEEVE,BRASS	2.92	CP5341-X.60	ORIFICE INSERT,BRASS	8.03
CP4958-SS	ADAPTER,SS,TRIG.TEEJ	41.34	CP5341-X.60-SS	ORIF.INSERT,ST.STL.	13.51
CP49881-NYB	DCV AIRJET BODY	83.16	CP5341-X1	ORIFICE INSERT,BRASS	8.03
CP5002-1	INLET BODY,BR,5000-	12.77	CP5341-X1-SS	ORIF.INSERT,ST.STL.	13.51
CP5002-1-AL	INLET BODY,AL,5000-	12.24	CP5341-X1.25	ORIFICE INSERT,BRASS	8.03
CP5002-2	INLET BODY,BR,5000-	12.77	CP5341-X1.25-SS	ORIF.INSERT,ST.STL.	13.51
CP5002-2-AL	INLET BODY,AL,5000-	12.24	CP5341-X1.5	ORIFICE INSERT,BRASS	8.03
CP5003	CONN.SCREW,BR,5000-	7.71	CP5341-X1.5-SS	ORIF.INSERT,ST.STL.	13.51
CP50101-1-NYB	1" SPLIT EYELET BODY	7.43	CP5341-X10	ORIFICE INSERT,BRASS	8.03
CP50104-NYB	1000 SINGLE HOSESHAK	3.57	CP5341-X10-SS	ORIF.INSERT,ST.STL.	13.51
CP50114-NYB	1000 DBLE HOSE SHANK	4.24	CP5341-X12	ORIFICE INSERT,BRASS	8.03
CP50116-AL	1MX3/4F ADAPTER	11.40	CP5341-X12-SS	ORIF.INSERT,ST.STL.	13.51
CP50144-3-SS	1/4-20X3 SCREW	2.72	CP5341-X14	ORIFICE INSERT,BRASS	8.03
CP50193-PP	TEE BODY	19.60	CP5341-X14-SS	ORIF.INSERT,ST.STL.	13.51
CP50286-1-NY	Q.T.CAP / BLACK	1.30	CP5341-X18	ORIFICE INSERT,BRASS	8.03
CP50286-2-NY	Q.T.CAP / WHITE	1.30	CP5341-X18-SS	ORIF.INSERT,ST.STL.	13.51
CP50286-3-NY	Q.T.CAP / RED	1.30	CP5341-X2	ORIFICE INSERT,BRASS	8.03
CP50286-4-NY	Q.T.CAP / BLUE	1.30	CP5341-X2-SS	ORIF.INSERT,ST.STL.	13.51
CP50286-5-NY	Q.T.CAP / GREEN	1.30	CP5341-X2.5	ORIFICE INSERT,BRASS	8.03
CP50286-6-NY	Q.T.CAP / YELLOW	1.30	CP5341-X2.5-SS	ORIF.INSERT,ST.STL.	13.51
CP50286-7-NY	Q.T.CAP / BROWN	1.30	CP5341-X22	ORIFICE INSERT,BRASS	8.03
CP50286-8-NY	Q.T.CAP / ORANGE	1.30			
CP50470-SS	STEM SUBASM	10.38			

PART NO.	DESCRIPTION	U.S.DOLLARS	PART NO.	DESCRIPTION	U.S.DOLLARS
CP5341-X22-SS	ORIF.INSERT,ST.STL.	13.51	CP5457	TIP BODY,BRASS, 5500	8.24
CP5341-X26	ORIFICE INSERT,BRASS	8.03	CP5458	CORE,BRASS,5500-	16.15
CP5341-X26-SS	ORIF.INSERT,ST.STL.	13.51	CP5474	CORE,BRASS 1/4TL&TTL	3.63
CP5341-X3	ORIFICE INSERT,BRASS	8.03	CP5474-SS	CORE ST.STL. 1/4TL	8.23
CP5341-X3-SS	ORIF.INSERT,ST.STL.	13.51	CP5477	STRAINER BODY,BRASS	8.38
CP5341-X4	ORIFICE INSERT,BRASS	8.03	CP5477-NP	STRAINER BODY,BRASS	10.08
CP5341-X4-SS	ORIF.INSERT,ST.STL.	13.51	CP55212-SS	M6 X 1MM HEX NUT	1.32
CP5341-X5	ORIFICE INSERT,BRASS	8.03	CP55219-NYB	5/8 QC HOSE BARB	7.78
CP5341-X5-SS	ORIF.INSERT,ST.STL.	13.51	CP55222-NYB	QUICK CONNECT PLUG	7.78
CP5341-X6	ORIFICE INSERT,BRASS	8.03	CP55223-NYB	VALVE BODY,450FB	49.77
CP5341-X6-SS	ORIF.INSERT,ST.STL.	13.51	CP55224-PP	NARROW TEE BODY,450	29.54
CP5341-X8	ORIFICE INSERT,BRASS	8.03	CP55239-VI	SEAT WASHER VITON	3.18
CP5341-X8-SS	ORIF.INSERT,ST.STL.	13.51	CP55242-PP	50X50 NARROW TEE	19.60
CP5341-Y.60	ORIFICE INSERT,BRASS	8.03	CP55243-NYB	QUICK CONNECT CAP	7.78
CP5341-Y1	ORIFICE INSERT,BRASS	8.03	CP55244-NYB	MANIFOLD TUBE BODY	29.50
CP5341-Y1-SS	ORIF.INSERT,ST.STL.	13.51	CP55246-50-SS	50 SERIES CLAMP	12.97
CP5341-Y1.25	ORIFICE INSERT,BRASS	8.03	CP55246-75-SS	75 SERIES CLAMP	14.90
CP5341-Y1.5	ORIFICE INSERT,BRASS	8.03	CP55265-NYB	1 HB OUTLET X M QC	8.50
CP5341-Y1.5-SS	ORIF.INSERT,ST.STL.	13.51	CP55266-15-EPR	3/4 FLOWBACK RINSE HOSE 15"	35.80
CP5341-Y10	ORIFICE INSERT,BRASS	8.03	CP55267-SS	1 ID HOSE CLAMP	10.70
CP5341-Y10-SS	ORIF.INSERT,ST.STL.	13.51	CP55268-NYB	3/4 HB OUTLET X M QC	8.50
CP5341-Y12	ORIFICE INSERT,BRASS	8.03	CP55276-SS	MOUNTING BRACKET	9.28
CP5341-Y12-SS	ORIF.INSERT,ST.STL.	13.51	CP55277-1-SS	MOUNTING BRACKET,SS	28.00
CP5341-Y14	ORIFICE INSERT,BRASS	8.03	CP55277-I	MOUNTING BRACKET	28.32
CP5341-Y18	ORIFICE INSERT,BRASS	8.03	CP55281	TUBE SUB-ASSEMBLY	62.71
CP5341-Y18-SS	ORIF.INSERT,ST.STL.	13.51	CP55284	PLUNGER SUB-ASSEMBLY	45.46
CP5341-Y2	ORIFICE INSERT,BRASS	8.03	CP55288-NYB	RETAINING RING, NYLON	4.55
CP5341-Y2-SS	ORIF.INSERT,ST.STL.	13.51	CP55289-NYB	NUT, NYLON (BLACK)	15.60
CP5341-Y2.5	ORIFICE INSERT,BRASS	8.03	CP55290-SS	WASHER CHROME CORE 18-FM	1.91
CP5341-Y2.5-SS	ORIF.INSERT,ST.STL.	13.51		SS	
CP5341-Y22	ORIFICE INSERT,BRASS	8.03	CP55291-302SS	SPRING,302SS	1.78
CP5341-Y26	ORIFICE INSERT,BRASS	8.03	CP55292-2	24 VOLT COIL ASSEMBLY	34.42
CP5341-Y26-SS	ORIF.INSERT,ST.STL.	13.51	CP55299-1-CE	VENDOR PART ONLY - FLOW	9.66
CP5341-Y3	ORIFICE INSERT,BRASS	8.03		METER BODY	
CP5341-Y3-SS	ORIF.INSERT,ST.STL.	13.51	CP5539	TEEJET PLG TIP,3/4T-	2.08
CP5341-Y4	ORIFICE INSERT,BRASS	8.03	CP5539-AL	TEEJET PLG TIP,3/4T-	1.99
CP5341-Y4-SS	ORIF.INSERT,ST.STL.	13.51	CP5542	INLET BODY,BR.5540	11.41
CP5341-Y5	ORIFICE INSERT,BRASS	8.03	CP5581	CORE,BRASS	3.63
CP5341-Y5-SS	ORIF.INSERT,ST.STL.	13.51	CP5581-SS	CORE,ST.STL.	10.46
CP5341-Y6	ORIFICE INSERT,BRASS	8.03	CP5594-1-304SS	SCREEN,SS,50M,1/4TW	22.50
CP5341-Y6-SS	ORIF.INSERT,ST.STL.	13.51	CP5594-10-304SS	SCRN,SS,100M,2&2-1/2	74.00
CP5341-Y8	ORIFICE INSERT,BRASS	8.03	CP5594-12-304SS	SCRN,SS,16M,3/8&1/2	18.33
CP5341-Y8-SS	ORIF.INSERT,ST.STL.	13.51	CP5594-13-304SS	SCRN,SS,16M,3/4&1TW	25.68
CP5341-Z10	ORIFICE INSERT,BRASS	8.03	CP5594-14-304SS	SCRN,16M,1-1/4&1-1/2	47.13
CP5341-Z12	ORIFICE INSERT,BRASS	8.03	CP5594-15-304SS	SCRN,SS,16M,2&2-1/2	74.00
CP5341-Z2	ORIFICE INSERT,BRASS	8.03	CP5594-16-304SS	SCREEN,SS,80M,1/4TW	25.62
CP5341-Z2.5	ORIFICE INSERT,BRASS	8.03	CP5594-17-304SS	SCRN,SS,80M,3/8&1/2	25.62
CP5341-Z3	ORIFICE INSERT,BRASS	8.03	CP5594-18-304SS	SCRN,SS,80M,3/4&1TW	25.68
CP5341-Z4	ORIFICE INSERT,BRASS	8.03	CP5594-19-304SS	SCRN,80M,1-1/4&1-1/2	47.13
CP5341-Z6	ORIFICE INSERT,BRASS	8.03	CP5594-2-304SS	SCN,SS,50M,3/8&1/2TW	17.91
CP5341-Z8	ORIFICE INSERT,BRASS	8.03	CP5594-20-304SS	SCRN,SS,80M,2&2-1/2	74.00
CP5343	TIP BODY,BRASS	5.30	CP5594-26-304SS	SCRN,SS,30M,3/4&1TW	25.68
CP5343-10W	TIP BODY,BRASS	5.30	CP5594-27-304SS	SCRN,30M,1-1/4&1-1/2	47.13
CP5343-12W	TIP BODY,BRASS	5.30	CP5594-28-304SS	SCRN,SS,30M,2&2-1/2	74.00
CP5343-2W	TIP BODY,BRASS	5.30	CP5594-29-304SS	SCREEN,SS,16M,9830	34.37
CP5343-3W	TIP BODY,BRASS	5.30	CP5594-3-304SS	SCRN,SS,50M,3/4&1TW	25.68
CP5343-4W	TIP BODY,BRASS	5.30	CP5594-30-304SS	SCREEN,SS,50M,9830	34.37
CP5343-5W	TIP BODY,BRASS	5.30	CP5594-32-304SS	SCREEN,SS,100M,9830	34.37
CP5343-6W	TIP BODY,BRASS	5.30	CP5594-33-304SS	SCREEN,SS,20M,9830	34.37
CP5343-8W	TIP BODY,BRASS	5.30	CP5594-36-304SS	SCRN,SS,200M,3/8&1/2	18.33
CP5343-UM	TIP BODY,BRASS	5.30	CP5594-37-304SS	SCRN,SS,200M,3/4&1TW	25.68
CP5344	TIP BODY,BRASS,TL-	5.30	CP5594-38-304SS	SCN,200M,1-1/4&1-1/2	47.13
CP5423	BODY,BR,BOOMJET NOZ.	148.23	CP5594-39-304SS	SCRN,SS,200M,2&2-1/2	74.00
CP5423-AL	BODY,AL,BOOMJET NOZ.	142.77	CP5594-4-304SS	SCRN,50M,1-1/4&1-1/2	47.13

PART NO.	DESCRIPTION	U.S.DOLLARS	PART NO.	DESCRIPTION	U.S.DOLLARS
CP5594-40-304SS	SCRN,SS,30M,3/8&1/2	18.33	CP5813-AL	HAND GRIP NUT,AL,2AL	3.90
CP5594-47-304SS	SCREEN SS 8MESH 2-12	74.00	CP5814-SS	SNAP RING,ST.STL, 2-	5.28
CP5594-5-304SS	SCN,SS,50M,2&2-1/2TW	74.00	CP5815-IZP	WASHER,STEEL-PLTD,2-	5.46
CP5594-57-304SS	SCREEN, 200 MESH	18.33	CP5818	TUBING,BRASS,2A- GUN	21.45
CP5594-6-304SS	SCREEN,SS,100M,1/4TW	22.50	CP5818-AL	TUBING,ALUM.,2A-AL	23.65
CP5594-7-304SS	SCRN,SS,100M,3/8&1/2	17.91	CP5819	ADJ.STEM,BRASS,2A	19.96
CP5594-8-304SS	SCRN,SS,100M,3/4&1TW	25.68	CP5819-AL	ADJ.STEM,ALUM,2A-AL	19.72
CP5594-9-304SS	SCN,100M,1-1/4&1-1/2	47.13	CP5833	SEAT SUB-ASSEMBLY	5.11
CP5609	LOCKNUT,BRASS	3.90	CP5833-AL	SEAT SUB-ASSEMBLY	5.38
CP5609-SS	LOCKNUT,ST.STL.	12.89	CP58350-1-CE	QT CAP CELCON BLACK	1.16
CP56613-SS	344 VALVE STEM	70.41	CP58350-10-CE	QT CAP CELCON VIOLET	1.16
CP56614-303SS	460BEC VALVE STEM	70.18	CP58350-2-CE	QT CAP CELCON WHITE	1.16
CP56615-SS	344 VALVE STEM	70.41	CP58350-3-CE	QT CAP CELCON RED	1.16
CP56619-2-303SS	346B STEM	154.42	CP58350-4-CE	QT CAP CELCON BLUE	1.16
CP56634-3-303SS	346B 3-WAY STEM	154.42	CP58350-5-CE	QT CAP CELCON GREEN	1.16
CP56708-NYB	CAP, NYLON	4.33	CP58350-6-CE	QT CAP CELCON YELLOW	1.16
CP56709-VI	QJS DIAPH VITON	3.72	CP58350-7-CE	QT CAP CELCON BROWN	1.16
CP56711-NYB	RETAINING RING NYLON	2.04	CP58350-8-CE	QT CAP CELCON ORANGE	1.16
CP56717-PPB	AIR CHEMSAVER BODY	6.75	CP58431-PP	430 VALVE BODY, PP	27.76
CP56718-PPB	AIR CHEMSAVER STEM	5.23	CP58432-PP	430 2WAY END CAP	5.56
CP56719-PPB	AIR CV INLET CAP	4.70	CP58433-SS	2-WAY BALL, 303SS	71.27
CP56721-PUR	FILTER, POLYURETHANE (FOAM)	1.75	CP58434-TEF	SEAL, TEFLON/PTFE (430)	25.26
CP56722-302SS	SPRING, 302SS	4.26	CP58435-SS	STEM 303SSFOR 430 BALL VALVE	38.50
CP56726-VITFE	QJ360 SEAL F/CF&E	8.16	CP58436-302SS	FLAT WASHER, SS	1.20
CP5691	TIP BODY,BRASS, 5780	14.63	CP58437-PP	430 MALE INLET ADAPTER	16.50
CP5692	CORE, BRASS, 5780-	25.10	CP58438-PP	430 FEMALE INLET ADAPTER	16.50
CP5692-SS	CORE, ST.STL.,5780-	148.20	CP58439-302SS	INLET QUICK CONNECT	3.21
CP5735-SS	SPRING,ST.STL,2-	7.44	CP58450-302SS	430 MOTOR RETAINING CLIP	4.44
CP5757-TEF	GASKET,TEFLON	8.90	CP58451-NYB	430 MOTOR CAM	8.57
CP5757-VI	GASKET,VITON	8.90	CP58455-PP	BYPASS END CAP	6.33
CP5772-NP	SPRAYER BODY,BR-NP	21.60	CP58457-1-304SS	BYPASS CLIP 90 DEG, 304SS	8.00
CP5775	WASHER,BRASS	2.30	CP58457-304SS	BYPASS CLIP, 304SS	7.01
CP5792-1/2	INLET BODY,BRASS,2-	146.60	CP58458-NYB	FB MANIFOLD BODY	10.26
CP5792-3/4	INLET BODY,BRASS,2-	146.60	CP58458-PP	FB MANIFOLD BODY	10.26
CP5792-3/4-AL	INLET BODY,ALUM,2-AL	53.96	CP58459-SS	430 FB BALL, 303SS	71.27
CP5792-GH	INLET BODY,BRASS,2-	146.60	CP58460-NYB	REGULATED BYPASS BODY	5.45
CP5792-GH-AL	INLET BODY,ALUM,2-AL	54.78	CP58460-PP	REGULATING BYPASS BODY	5.45
CP5794	ADJUST.SLEEVE,BR,2-	62.38	CP58461-PP	REGULATING BYPASS PLUNGER	4.26
CP5794-AL	ADJUST.SLEEVE,AL,2AL	27.62	CP58462-PP	REG BYPASS DIAL	7.52
CP5795	TUBING,BRASS,2-	39.06	CP58463-NY	REG BYPASS INDICATOR RING	7.41
CP5795-AL	TUBING,ALUM,2AL-	31.23	CP58464-302SS	REG BYPASS DIAL RET CLIP	5.25
CP5796	ADJUSTING STEM,BR,2-	23.57	CP58465-302SS	430 SCREW STAINLESS STEEL	3.95
CP5796-AL	ADJUST. STEM,AL-2AL-	21.29	CP58468-1-SS	#1 CONNECTING ROD	61.14
CP5797	ADJ. STEM END,BR,2-	11.39	CP58468-10-SS	#10 CONNECTING ROD #430 MANIFOLD BALL VALVE	61.14
CP5797-AL	ADJ. STEM END,AL,2AL	13.51	CP58468-11-SS	#11 CONNECTING ROD #430 MANIFOLD BALL VALVE	61.14
CP5798-NY	SEAT PLATE,NYLON, 2-	8.93	CP58468-12-SS	#12 CONNECTING ROD #430 MANIFOLD BALL VALVE	61.14
CP5800-NYB	PRESSURE PLATE, NY	9.53	CP58468-13-SS	#13 CONNECTING ROD #430 MANIFOLD BALL VALVE	61.14
CP5801	SPRAY HOUSING,BR,2A	13.94	CP58468-14-SS	#14 CONNECTING ROD #430 MANIFOLD BALL VALVE	61.14
CP5801-AL	SPRAY HOUSING,AL,2AL	14.54	CP58468-15-SS	#15 CONNECTING ROD #430 MANIFOLD BALL VALVE	61.14
CP5802	GUIDE WASHER,BR,2-	7.64	CP58468-2-SS	#2 CONNECTING ROD	61.14
CP5802-AL	GUIDE WASHER,AL,2AL-	7.64	CP58468-3-SS	#3 CONNECTING ROD #430 MANIFOLD BALL VALVE	61.14
CP5804	CAP-OC-TIP,BR,2-	14.54	CP58468-4-SS	#4 CONNECTING ROD	61.14
CP5804-AL	CAP-OC-TIP,ALUM,2AL-	14.54	CP58468-5-SS	#5 CONNECTING ROD	61.14
CP5805-BU	GASKET,BUNA-N,2	5.46	CP58468-6-SS	#6 CONNECTING ROD	61.14
CP5805-NY	GASKET,NYLON,2-	9.60	CP58468-7-SS	#7 CONNECTING ROD	61.14
CP5806-BU	GASKT-OC-TIP,BUN-N,2	2.92	CP58468-8-SS	#8 CONNECTING ROD	61.14
CP5806-NY	GASKT-OC-TIP,NYLON,2	5.83	CP58468-9-SS	#9 CONNECTING ROD	61.14
CP5808-BU	G.HOSE WASHER,BUNA-N	6.19	CP58469-SS	E-CLIP RETAINING RING, 17PH SS	1.22
CP5808-POL	G.HOSE WASHER,POL.	6.19			
CP5809-LEA	PACKING,LEATHER, 2-	2.37			
CP5811	PACKING SCREW,BRASS	5.17			
CP5811-AL	PACKING SCREW,ALUM.	5.17			
CP5812-INP	SLV.COLLAR,STL-PD,2-	8.57			
CP5813	HAND GRIP NUT,BR,2-	3.90			

PART NO.	DESCRIPTION	U.S.DOLLARS	PART NO.	DESCRIPTION	U.S.DOLLARS
CP58473-NYB	LQC X 3/4" NPT F	20.56	CP5896-ALSS	ADJ.SCREW ASB,AL&SS	12.68
CP58474-NYB	LQC X 1" NPT F	20.56	CP5897	HANDL.ROD,BR,5890	3.26
CP58475-NYB	LQC X 1-1/4" NPT F	20.56	CP5897-AL	HANDL.ROD,AL,5890	3.26
CP58476-NYB	1-1/2" NPT F INLET LQC BLACK NYLON	20.56	CP5898	LOCKNUT,BRASS,6815 &	2.78
CP58477-NYB	QUICK CONNECT CAP FITTING	20.56	CP5898-AL	LOCKNUT,ALUMINUM	2.78
CP58478-NYB	LQC X 1/4" GAUGE PORT NPT F	20.56	CP5899-BU	GASKET,BUNA-N,5890-	2.30
CP58478-PP	LQC GAUGE PT NPT	20.56	CP5899-VI	GASKET,VITON,5890	13.36
CP5850-1/2	BODY,BRASS,1/2ATW-B	96.87	CP5900-1-SS	SPRING,ST.STL,5890	4.84
CP5850-1/2-AL	BODY,ALUM.,1/2ATWAL	61.51	CP5900-2-SS	SPRING,ST.STL,5890	4.84
CP5850-3/4	BODY,BRASS,3/4ATW-B	96.87	CP5903-1-POL	BOTTLE CAP	7.04
CP5850-3/4-AL	BODY,ALUM.,3/4ATWAL	61.51	CP5903-POL	BOTTLE CAP	7.04
CP5851	CAP,BRASS,-ATW-B	12.77	CP5909-SS	LOCK.SCREW,SS,9192-	5.23
CP5851-IZP	CAP STL-PLTD.ATW	14.90	CP5915	SEAT STUD,BR.12B,C,D	8.11
CP5852-FC	GASKET,FC, ATW-	4.20	CP5924	BOOMJT ADAPTER,BR,#2	13.19
CP5852-NY	GASKET,NYLON, ATW-	6.15	CP5928	END CAP,BR,5927-	13.71
CP58551-NYB	LQC X 1" HB	20.56	CP5929	SHUTOFF SCREW,BRASS	3.12
CP58551-PP	LQC X 1" HB	20.56	CP5934-BU	GASKET,BUNA-N,9192-	2.30
CP58552-NYB	1 1/4 Straight Hose Barb Fitting	20.56	CP5938	ADAPTER,BR,12C-3/4	15.24
CP58552-PP	LQC X 1-1/4" HB	20.56	CP5969	INLET BODY BR. 5932	24.78
CP58553-NYB	LQC X 1-1/2" HB	20.56	CP5972-NP	AIR CONN.ASB,BR-NP	19.28
CP58553-PP	LQC X 1-1/2" HB	20.56	CP5994-NY	HAND GRIP NYLON	14.04
CP58554-NYB	LQC X 2" HB	20.56	CP6021	TUBING,BRASS, 12A	19.81
CP58554-PP	LQC X 2" HB	20.56	CP6022	STEM,BRASS, 12A	12.82
CP58555-SS	M8 SPLIT LOCK WASHER	2.16	CP6106	DISC ADAPTER,BR,2-	3.79
CP58556-PP	END CAP M50, PP	31.54	CP6106-AL	DISC ADAPTER,AL,2AL-	3.79
CP5856	BODY,BR,5880 BOOMJET	208.80	CP6157	PACKING SCREW,BR,2-	4.81
CP58565-NYB	QUICKJET LUGS SUB-ASBLY	8.88	CP6157-ALA	PACKING SCREW,AL,2	7.02
CP58568-NYB	F75 MNFD TUBE BODY	74.05	CP6227-TEF	DIAPHRAGM,TEFLON	1.17
CP58571-PP	CROSS BODY F50	33.75	CP6237	ADAPTER-OC,BRASS,12-	13.66
CP58572-EPR	1" FLANGE GASKET, EPDM	5.27	CP6250	ADAPTER,BRASS,6260	6.73
CP58583-NYB	CLIP, BLACK NYLON	1.52	CP6250-I	ADAPTER STEEL,6260	7.71
CP58588-2-NYB	1/2" UPPER CLAMP BLACK NYLON	2.75	CP6250-SS	ADAPTER,SS,6260	26.80
CP58588-3-NYB	3/4" UPPER CLAMP BLACK NYLON	2.75	CP6264	CAP,BRASS,1/4TWB	11.16
CP58588-4-NYB	1" UPPER CLAMP BLACK NYLON	2.75	CP6266	CAP,BRASS,3/4&1TW-B	60.11
CP58588-5-NYB	25 MM UPPER CLAMP	2.75	CP6266-I	CAP,CAST IRON,3/4&1TW	50.93
CP58588-6-NYB	28 MM UPPER CLAMP	2.75	CP6266-SS	CAP,ST.STL.3/4&1TWSS	129.12
CP58588-NYB	20 MM UPPER CLAMP	2.75	CP6292	ORIFICE RETAINER,BRASS	5.41
CP58589-VI	GASKET 55295-4 & 55300-1 CHEMSAVER	3.97	CP63005-VI	DIAPHRAGM, VITON	2.30
CP5866-12/GH	INLET BODY,BRASS,12	85.19	CP6302	BODY,BRASS,6290 JET	42.37
CP5866-12/GH-AL	INLET BODY,ALUM,12AL	61.54	CP6302-AL	BODY,ALUMINUM,6290	41.18
CP5869	SPRAY HOUSING,BR,12-	10.45	CP6302-SS	BODY,ST.STL,6290 JET	122.54
CP5869-AL	SPRAY HOUSNG,AL,12AL	10.11	CP63025-1-F75-PP	126 STRAIN HEAD W/GP	43.54
CP5871-BU	TIP GASKET,BUNA-N,12	5.46	CP63025-F-PP	STRAINER HEAD, PP	36.91
CP5872	GUIDE SLEEVE,BR,12-	4.55	CP63061-VI	DIAPH.VITON THICK	2.25
CP5872-AL	GUIDE SLEEVE,AL,12AL	4.55	CP63065-1-1/4-PP	1-1/4" NPT STRAINER HEAD, PP	36.91
CP5873	CORE BODY,BRASS,6190	7.44	CP63066-1-1/2-PP	1-1/2" NPT STRAINER HEAD, PP	36.91
CP5873-AL	CORE BODY,ALUM, 6190	7.44	CP63150-EPR	126 STRAINER GASKET	4.41
CP5874	CORE,BRASS, 6190	17.27	CP63150-VI	126 GASKET, VITON	11.21
CP5874-AL	CORE,ALUMINUM,6190	17.27	CP63381-PUR	DIAPHRAGM, POLYURETHANE	2.30
CP5878	TUBING,BRASS, 12	33.25	CP63448-PP	346 PR BALL	96.16
CP5878-AL	TUBING,ALUMINUM,12AL	32.11	CP63448-SS	PRESSURE RELIEFBALL VALVE 316SS	232.79
CP5879	STEM,BRASS, 12	13.97	CP63449-PP	1-1/4" PIPE PLUG	19.08
CP5879-AL	STEM,ALUMINUM, 12AL	13.44	CP63580-SS	BALL VALVE STEM	70.41
CP5882	HAND GRIP STUD,BR,12	16.52	CP63581-PP	MOTOR ADAPTER	5.95
CP5882-NP	HD.GR.STUD,BR-PLD,12	16.52	CP63605-CE	EXTRACTION TOOL	4.35
CP5883	PACKING WASHER,BR,12	2.37	CP6361-NP	STR.SUPPORT,BRASS-NP	12.09
CP5883-AL	PACK. WASHER,AL,12AL	2.37	CP63769-1-1/4-PP	STRAINER HEAD W/LABL	36.91
CP5884-INP	H-G COLLAR.STL-PL,12	12.11	CP63769-1-PP	STRAINER HEAD W/LABL	18.10
CP5893	BODY,BRASS,5890 PRV	69.13	CP63769-3/4-PP	STRAINER HEAD W/LABL	18.10
CP5896	ADJ.SCREW ASB,BR,PRV	8.98	CP6407	ADAPTER,BRASS,2-	19.94
			CP6407-AL	ADAPTER,ALUM.,2AL-	16.48
			CP6468-INP	TRIGGER STOP,INP	4.12
			CP6469-SS	TRIG.BUTTON,SS,6466	4.71



PART NO.	DESCRIPTION	U.S.DOLLARS	PART NO.	DESCRIPTION	U.S.DOLLARS
CP6492	INLET BODY,BR,42& 43	62.92	CP6865-AL	ADAPTER,AL,42B GUNJT	23.48
CP6492-AL	INLET BODY,AL,42& 43	44.31	CP6866-1/2	PIPE ADAPTER,BR,43C-	20.35
CP6492-SS	INLET BODY,SS,42& 43	198.96	CP6866-1/2-AL	PIPE ADAPTER,AL,42C-	20.35
CP6509-INCP	TRIGGER,STEEL-PL,44-	16.23	CP6866-1/2-SS	PIPE ADAPTER,SS,42C-	80.11
CP6509-INP	TRIGGER,STEEL-PL,46	8.98	CP6866-3/4	PIPE ADAPTER,BR,42C-	20.35
CP6509-SSP	TRIGGER S.S.,50 GUN	65.06	CP6866-3/4-AL	PIPE ADAPTER,AL,42C-	20.35
CP6510-INP	TRIG.STOP,STL-PLT	7.90	CP6866-3/4-SS	PIPE ADAPTER,SS,42C-	80.11
CP6524	INLET BODY,BR,6240	11.39	CP6867	ADAPTER,BR,43D GUNJT	20.35
CP6526	NOZZLE BODY,BR.,6240	8.81	CP6867-AL	ADAPTER,AL,43D GUNJT	20.35
CP6535-1-AL	BODY,ALUM., 6532-PRV	60.66	CP6867-SS	ADAPTER,SS,43D GUNJT	71.10
CP6544	GUI.SEAT,BR,PRES.R.V	11.40	CP6871	TUBING,BRASS,43A-	26.10
CP6544-AL	GUI.SEAT,AL,PRES.R.V	11.40	CP6871-AL	TUBING,ALUM.,43A-AL	26.10
CP6545	SPR.RETAINER,BR,PRV	2.78	CP6896	INLET BODY,BRASS,18A	105.90
CP6546-SS	OUTS.SPRING,SS, PRV	5.52	CP6896-AL	INLET BODY,ALUM 18AL	43.71
CP6547-SS	INS.SPRING,SS, PRV	4.81	CP6898-3/4-AL	Buy from China P/n# CP6898-1-AL-3/4	48.14
CP6548-AL	SCREW CAP,ALUM, 6532	7.32	CP6898-GH-AL	INLET BODY,ALUM,143	48.14
CP6549-ALSS	ADJ.SCREW ASB.AL&SS	15.21	CP6934-13/4-AL	BODY,ALUMINUM, #17-	88.47
CP6550-AL	HANDLE ROD,AL,6532	2.79	CP6934-3/4-AL	BODY,ALUMINUM, #17-	88.47
CP6551-AL	JAM NUT,ALUM.	2.79	CP6943-AL	TUBING GASKET,AL,42-	2.37
CP6558-SS	TEEJET BDY, SS ,6472	43.54	CP6956-CE	VALV.STEM.CELCON,#17	6.09
CP6559-SS	HOSE SHANK, SS ,6472	26.45	CP6958-POL	SEAT PLATE,POLY. #17	10.08
CP6561-SS	HOSE SHANK,SS,6471-	33.68	CP6959-SS	VALVE SPRING,SS,#17-	4.94
CP6588-IZP	SPR.SCREW,STL-PLT,43	7.44	CP6962	INLET BODY,BR., 6960	12.81
CP6588-SS	SPRING SCREW 303SS	32.87	CP6963	LIQUD TUBING,BR,6960	19.08
CP6589-IZP	ADJ.NUT,STL-PLTD,43-	7.06	CP6965	NOZZLE TIP,BR., 6960	6.65
CP6591-SS	SPRING STUD,SS,44-	5.41	CP6966	ADAPTER,BRASS, 6960	11.34
CP6592-302SS	SPRING GDE DISC302SS	3.79	CP6971-AL	SELECTOR CAM,AL,#17-	6.60
CP6593-1-SS	SPRING.SS.42L & 43L GREEN	7.64	CP6971-ALEF	SELECTOR.CAM,ALEF,17	7.49
CP6593-2-SS	SPRING,SS,42H & 43H	7.64	CP6972-SS	MAIN STEM,ST.STL,#17	16.26
CP6594-SS	SPRING,ST.STL.,44-	2.43	CP6975-BU	GASKET,BUNA-N,#17-	13.14
CP6595-SS	TR.STOP SPRING,SS,44	4.54	CP6976-IZP	WASHER STL-PLTD,#17-	5.90
CP6597-INP	TRGR GUIDE,STL-PL,44	23.65	CP6984-416SS	STEM,416SS,142-AL	11.38
CP6599	LOCKNUT BRASS	5.17	CP7059	IN.ADPTR,BR,6815-3/4	15.10
CP6599-NP	LOCKNUT,BRASS PLATED	5.17	CP7059-174PH	INLET ADAPTER 174PH	64.81
CP6599-SS	LOCKNUT ST.STL.	35.48	CP7059-2-174PH	INLET ADAPTER 174PH	64.81
CP6601-302SS	PACK.WASHER,302SS,43	6.07	CP7079-AL	GASKET,ALUMINUM, 43-	9.77
CP6602-LEA	PACKING,LEATHER, 42-	5.28	CP7079-CU	GASKET,COPPER, 43-	9.77
CP6602-TEF	PACKING,TEFLON,42&43	13.26	CP7079-CUENP	GASKET COPPER EL.PL.	12.38
CP6603-416SS	STEM,416SS,42	29.96	CP7079-SS	GASKET STL.STEEL	12.78
CP6604	TUBING,BRASS,42 & 43	56.74	CP7139-1-M	SCREEN,MONL,50M,7130	16.23
CP6604-AL	TUBING,ALUM,42 & 43	56.74	CP7139-2-M	SCREEN,MON,100M,7130	16.23
CP6618	NUT,BRASS, 12	2.30	CP7175-10-420HSS	BODY,420HSS,1/4AX	56.15
CP6618-AL	NUT,ALUMINUM, 12AL	2.30	CP72005-PP	#75 FLNG END CAP 346	28.41
CP6634	HEX.NIPPLE, BRASS	2.65	CP7206-IZP	RIVET,IR-CAD.PLT,#17	8.23
CP6647	ADAPTER,BRASS	4.25	CP7220	OUTLET BODY,BR.,7205	7.13
CP6678	LOCK RING,BRASS,6960	7.54	CP7220-1	INLET BODY,BR,7205	7.13
CP6681-1-POL	BOTTLE,PLASTIC,1PT.	14.95	CP7220-1-AL	INLET BODY,AL,7205	7.13
CP6710-1-BU	SEAT PLATE,BUNA-N,46	6.04	CP7220-AL	OUTLET BODY,AL.,7205	7.13
CP6710-NY	SEAT PLATE,NYLON,43	11.41	CP7221-NY	GASKET.NYLON, 7205-	2.30
CP6710-POL	SEAT PLATE,POLY,42	10.65	CP7222-NY	GASKET,NYLON,7205-	2.30
CP6710-TEF	SEAT PLATE,TEFLON,43	10.65	CP7222-VI	OUTLET BODY GASKET	4.50
CP6789	IN.ADPT,BR,6815-1/2	15.10	CP72238-PP	50X90X1-1/4 HOSEBARB	9.75
CP6818-1/2	BODY,BRASS,6815-1/2	75.79	CP72239-PP	50X90X1-1/2 HOSEBARB	9.75
CP6818-1/2-AL	BODY,ALUM,6815-1/2--	75.79	CP7272	INLET NIPPLE,BR,7199	10.57
CP6818-3/4	BODY,BRASS,6815-3/4	75.79	CP7273	INL.ADAPTER,BR,7199	13.88
CP6818-3/4-AL	BODY,ALUM,6815-3/4AL	75.79	CP7274	BODY,BR,7199 MULTEEJ	19.11
CP6819-30	TUBING,BR.EXTENSIONS	22.86	CP7275	RETAINER,BRASS, 7199	10.06
CP6849-1-IZP	HANDLE,STL-PLTD,#17-	13.81	CP7276-BU	GASKET,BUNA-N,7199	3.49
CP6863	SEAT HOLDER,BRASS,43	8.01	CP7292	CAP NUT,BRASS,7205-	2.41
CP6863-AL	SEAT HOLDER,ALUM, 43	8.01	CP7292-AL	CAP NUT,ALUM ,7205-	2.29
CP6863-ENP	SEAT HOLDER,BREN,P,43	12.41	CP7402-0.5	CAP,BRASS, 1/8A&BW	9.36
CP6863-SS	SEAT HOLDER ST.STL.	79.93	CP7402-1	CAP,BRASS, 1/8A&BW	9.36
CP6864-416SS	STEM,416SS,43B,C,D	53.68	CP7402-2	CAP,BRASS, 1/8A&BW	9.36
CP6865	ADAPTER,BR,42B GUNJT	23.48			

PART NO.	DESCRIPTION	U.S.DOLLARS	PART NO.	DESCRIPTION	U.S.DOLLARS
CP7402-3	CAP,BRASS, 1/8A&BW	9.36	CP7623-SS	RIVET ST.STL.50 GUN	7.27
CP7402-5	CAP,BRASS, 1/8A&BW	9.36	CP7626-BU	G.H.GSKT,1/2THK.BUNA	2.30
CP7415-304SS	STRAP,304SS,7421-	12.00	CP7670-430SS	STEM FOR 7620 SWIVEL	5.83
CP7415-I	BODY STRAP,STL,7421-	7.64	CP7671-1/2-SS	BALL, STAINLESS STEEL	8.38
CP7415-IZP	STRAP,STL-PLTD,7421-	4.84	CP7671-1/4-SS	BALL,STAINLESS STEEL	5.04
CP7416-304SS	CLAMP,304SS,7421-	11.99	CP7671-3/16-SS	3/16, 302SS-BALL	8.11
CP7416-IZP	CLAMP,STL-PLTD,7421-	3.95	CP7671-3/8-SS	BALL,STAINLESS STEEL	9.40
CP7417	BODY,BRASS,7421-	7.90	CP7671-5/16-SS	BALL ST.STL,CH.VALVE	8.38
CP7417-SS	BODY,ST.STL,7421-	14.55	CP7671-5/32-SS	BALL,ST.STL,CH.VALVE	6.08
CP7418-BU	GASKET,BUNA-N, 7421-	3.58	CP7671-5/8-SS	BALL,STAINLESS STEEL	12.02
CP7418-VI	GASKET, VITON.7421	7.49	CP7671-7/32-SS	BALL,STAINLESS STEEL	5.04
CP7419-304SS	STRAP,304SS,7421-	12.00	CP7677-18-SS	STEM,ST.STL,22L-7676	40.03
CP7419-IZP	STRAP,STL-PLTD,7421-	7.64	CP7677-24-SS	STEM,ST.STL,23L-7676	52.46
CP7420-304SS	CLAMP,304SS,7421-	11.99	CP7677-36-SS	STEM,ST.STL,22L-7676	70.61
CP7420-IZP	CLAMP,STEEL-PLD,7421	6.16	CP7677-48-SS	STEM,ST.STL,22L-7676	92.88
CP7451-1	INLET BODY,BR,7450B-	7.47	CP7677-8-SS	STEM,ST.STL,22L-7676	32.39
CP7451-1-AL	INLET BODY,AL,7450B-	7.50	CP7678	STEM END,BR,23L-7676	11.35
CP7451-2	INLET BODY,BR,7450	7.47	CP7678-SS	STEM END,SS,22L-7676	33.63
CP7451-2-AL	INLET BODY,AL., 7450	7.50	CP7679	SPIDER,BRASS,22-7676	9.26
CP7452	OUTLET BODY,BR,7450-	7.47	CP7679-1	GUIDE NUT,BR,23L7676	4.54
CP7452-1	INLET BODY,BR,7620-	7.47	CP7679-1-SS	GUIDE NUT,SS,22-7676	19.94
CP7452-1-AL	INLET BODY,AL,7620-	7.50	CP7686-304SS	CLAMP,304SS,7421	11.99
CP7452-2-AL	OUTLET BODY,AL.,7450	7.50	CP7686-AL	CLAMP,ALUMINUM,7421-	7.20
CP7452-3	INLET BODY,BR,7620B	7.47	CP7686-IZP	CLAMP,STL-PLTD,7421-	6.16
CP7452-3-AL	INLET BODY,AL,7620B	7.50	CP7687-304SS	STRAP,304SS,7421-	12.00
CP7452-AL	OUTLET BODY,AL,7450-	7.50	CP7687-AL	BODY STRAP, AL,7421-	7.20
CP7453-430SS	STEM,430 ST.STL.7450	4.84	CP7687-IZP	STRAP,STL.PLTD,7421-	7.64
CP7472-ENP	INLET BODY,BRASS ENP	34.01	CP7688-IZP	SCREW,IZP	2.29
CP7477-IZP	TRG.LOCK PLTD. #46	7.64	CP7688-SS	SCREW,ST.STL.	5.04
CP7479-INP	TRGGR STOP,ST-PLD,25	6.70	CP7694-430SS	RIVET 430SS	2.37
CP7480-IZP	SPRING SCREW IZP 22-	7.43	CP7696-1-IZP	3/8-16X1 SCRW,STL-PL	7.79
CP7481-INP	YOKE,STL-PLTD,31PGA	17.34	CP7696-1-SS	3/8-16X1 SCREW,SS	7.08
CP7482-1-BR302S	STEM ASB.BR&302SS 23	11.09	CP7697	1/2-13 CAP SCREW,BR.	8.42
CP7482-1-SS302S	STEM ASB.SS&302SS 23	17.15	CP7697-SS	1/2-13 SCREW,ST.STL.	11.93
CP7484-SS	STEM NUT, SS	4.76	CP7698	SCREW,BRASS,-HSW+	2.30
CP7485-ENP	PACK.SCREW,BR-ENP,22	4.81	CP7698-SS	1/4-20 SCREW,ST.STL.	2.79
CP7485-SS	PACK.SCREW,SS,22-SS.	17.91	CP7708-AL	SCREW,ALUM. -12-AL	2.30
CP7486-IENP	LOCKNUT,STL PLATED	6.95	CP7708-SS	SCREW,ST.STL, 12-	2.81
CP7486-SS	LOCKNUT,ST-STL,22SS-	8.23	CP7709-302SS	#10 WASHER,302SS	10.08
CP7487-1-CTEF	PACKING,TEF-CARBON	11.38	CP7717-1-BU	O-RING,BUNA-N	4.98
CP7487-1-TEF	PACKING,TEFLON,22-WHITE	5.70	CP7717-1-VI	O-RING, VITON	7.06
CP7487-LEA	PACKING,TH.LEATH,22-	2.30	CP7717-10-BU	O-RING, BUNA-N, 5780	7.23
CP7489-SS	SPRING,ST.STL,25-	2.30	CP7717-10-VITEF	O-RING, VITON & TEF	8.47
CP7490	VALVE SEAT,BRASS,22-	5.25	CP7717-11-BU	O-RING, BUNA-N	5.46
CP7490-BRCTEF	VALVE SEAT BR&CTEF	11.73	CP7717-11-VI	O-RING, VITON	9.00
CP7490-BRTF	VALVE SEAT,BR&TEF,22	8.68	CP7717-15-EPR	O-RING, EPR	4.98
CP7490-SSCTEF	VALVE SEAT SS&CTEF	19.87	CP7717-15-VI	O-RING, VITON	9.85
CP7490-SSTEF	SEAT,SS&TEFLON,22&31,S/S	12.89	CP7717-2-016-BUTEF	O-RING, BUNA-N & TEF	8.03
CP7491-SS	SPRING STUD,303SS	6.60	CP7717-2-016-VITEF	O-RING, VITON & TEF	13.90
CP7498-SS	STEM NUT,ST.STL.,#46	5.67	CP7717-2-024-VI	O-RING, VITON	3.71
CP7500-AL	PACKING SCREW,ALUM.	9.13	CP7717-2-026-EPR	O-RING, RUBBER	2.84
CP7502-AL	SEAT HOLDER,ALUM,#46	5.17	CP7717-2-107-VI	O-RING, VITON	0.32
CP7503-LEA	PACKING,TH.LEATH,#46	3.26	CP7717-2-108-BU	O-RING, BUNA-N	2.43
CP7504-SS	SPRING,ST.STL., #46	5.66	CP7717-2-108-EPR	O-RING, EPR	2.91
CP7528	BODY,BR,7521-SPLT-EY	7.90	CP7717-2-109-VI	O-RING, VITON	7.49
CP7528-SS	BODY,SS,7521-SPLT-EY	14.55	CP7717-2-11/90-BU	O-RING, BUNA-N, 15950	5.37
CP7529	BODY,BR,7521-SPLT-EY	7.90	CP7717-2-110-EPR	O-RING, EPR	1.35
CP7529-SS	BODY,SS,7521-SPLT-EY	14.55	CP7717-2-118-VI	3/4" O-RING	4.41
CP7546-IZP	SCREW STEEL ZINC PL.	2.29	CP7717-2-119-VI	QJ370 O-RING, VITON	13.26
CP7546-SS	SCREW,ST.STL.	4.85	CP7717-2-129-VI	O-RING, VITON	3.86
CP7562-10	CAP,BRASS, 1/8A&BW	9.36	CP7717-2-155/40-EPR	O-RING	3.72
CP7562-8	CAP,BRASS, 1/8A&BW	9.01	CP7717-2-223-VI	O-RING, VITON	5.69
CP7622-302SS	#6 BURR 302SS	2.30	CP7717-2-225-VI	O-RING, VITON	1.45
CP7623-IZP	RIVET STL-PLATED	2.30	CP7717-2-229-VI	O-RING, VITON	2.43

PART NO.	DESCRIPTION	U.S.DOLLARS	PART NO.	DESCRIPTION	U.S.DOLLARS
CP7717-2-322-VI	O-RING, VITON	8.08	CP7717-7-EPR	O-RING, EPR	6.83
CP7717-2-347-VI	O-RING, VITON	155.19	CP7717-7-VI	O-RING, VITON	10.19
CP7717-2/007-BU	O-RING, BUNA-N	8.86	CP7717-M10.5X1.5-VI	O-RING FOR CAP AND GASKET ASSEMBLIES	0.59
CP7717-2/007-VI	O-RING, VITON	11.54	CP7717-M10X1.8-VI	O-RING, VITON	1.11
CP7717-2/016-BU	O-RING, BUNA-N	0.76	CP7717-M12X2.5-VI	O-RING, VITON	2.84
CP7717-2/016-VI	O-RING, VITON	2.62	CP7717-M28X3-EPRTFE	O-RING, EPR & TEF	4.85
CP7717-2/018-BU	O-RING, BUNA-N	1.55	CP7717-M28X3-VITFE	O-RING, VITON & TEF	13.26
CP7717-2/021-EPR	O-RING EPR BLACK W/PURPLE DOT	0.76	CP7717-M33.27X1.02-VI	O-RING, VITON	11.54
CP7717-2/021-VI	O-RING, VITON	2.37	CP7717-M38X4-VI	O-RING, VITON F/AA122ML-QC-PP	8.12
CP7717-2/108-VI	O-RING, VITON 140A	7.63	CP7717-M4.2X1.9-VI	O-RING, VITON	6.43
CP7717-2/109-EPR	O-RING, EPR	3.25	CP7717-M4.3X2.4-VI	O-RING, VITON	2.25
CP7717-2/11-BU	O-RING, BUNA-N	8.22	CP7717-M4.8X1.8-VI	O-RING, VITON	10.19
CP7717-2/11-VI	O-RING, VITON	13.94	CP7717-M40X4-VI	O-RING, VITON	2.78
CP7717-2/11-VITEFL	O-RING, VITON, COATED W/ TEF	13.94	CP7733	BODY,BR,7421-SPLT-EY	8.01
CP7717-2/110-BU	O-RING, BUNA-N	0.96	CP7756-ALHSS	GUI.SEAT,AL-HSS,6815	28.42
CP7717-2/110-VI	O-RING, VITON	1.44	CP7756-BRHSS	GUI.SEAT,BR-HSS,6815	28.42
CP7717-2/111-VI	O-RING,VITON COLOR BROWN	9.00	CP7758-1/2-ALHSS	INL.ADAPTR,6815-1/2	29.98
CP7717-2/115-VI	O-RING, VITON	3.38	CP7758-1/2-BRHSS	INL.ADAPTER,6815-1/2	32.87
CP7717-2/116-VI	O-RING, VITON	4.71	CP7758-3/4-ALHSS	INL.ADAPTER,6815-3/4	29.98
CP7717-2/117-VI	O-RING, VITON	1.50	CP7758-3/4-BRHSS	INL.ADAPTER,6815-3/4	32.87
CP7717-2/120-VI	O-RING, VITON, AA155	8.25	CP7771	REDUC.BSHING,BRASS	12.80
CP7717-2/121-EPR	O-RING, EPR	4.55	CP7776-IZP	WASHER,STL,PLT,24AUA	3.26
CP7717-2/121-VI	O-RING, VITON	17.84	CP7778-410SS	SHKPRF.WASHER, SS	5.98
CP7717-2/13-BU	O-RING, BUNA-N	5.91	CP7884-SS	SEAT PLUG,SS,7884-1	26.20
CP7717-2/13-EPR	O-RING, EPR	3.44	CP7890	CAP,BRASS,22-	12.04
CP7717-2/13-VI	O-RING, VITON	9.00	CP7890-INP	CAP,STL,PLTD,80GUN	12.64
CP7717-2/131-VI	O-RING, VITON	12.70	CP7890-IZP	CAP STL,PLATED,50-	12.64
CP7717-2/135-VI	O-RING, VITON, 124SC	13.14	CP7890-NP	CAP NICKLE-PLTD.	12.42
CP7717-2/14-BU	O-RING, BUNA-N	5.83	CP7890-SS	CAP ST.STL.,50	29.29
CP7717-2/14-VI	O-RING, VITON, 12690	9.00	CP7890-SSP	CAP,ST.STL-POL.,25-	34.49
CP7717-2/145-VI	O-RING, VITON, 346M	19.79	CP7892-IZP	KEY, STL PLATED	4.55
CP7717-2/15-VI	O-RING, VITON, 106-	11.20	CP7894-TEF	TIP GASKET TEFLON	8.31
CP7717-2/17-VI	O-RING, VITON 36	10.45	CP7895-TEF	PACKNG,TEFL,22HPSSTC	5.11
CP7717-2/207-EPR	O-RING, EPR	2.12	CP7902-AL	3/4 OUT.ADAPTR,AL,17	14.78
CP7717-2/207-VI	O-RING, VITON	5.98	CP7903-INP	TRIGGER SUB-ASB,7900	9.77
CP7717-2/208-VI	O-RING, VITON	3.52	CP7919	WASHER, BRASS	14.50
CP7717-2/209-VI	O-RING, VITON	12.61	CP7923	NUT,BRASS	7.83
CP7717-2/211-BU	O-RING, BUNA-N	6.95	CP7924-410SS	SHAKEPROOF WASHER,410SS	3.26
CP7717-2/211-VI	O-RING, VITON	15.18	CP7965-IZP	HEX NUT,STEEL	3.00
CP7717-2/213-VI	O-RING, VITON	20.05	CP7965-SS	10-24,HEX.NUT,ST.STL	2.51
CP7717-2/215-VI	RETAINER O-RING	5.78	CP7967-IZP	HEX NUT 5/16-18 IZP.	1.79
CP7717-2/216-VITEF	O-RING, VITON & TEF	8.47	CP7972	WING NUT,BRASS,5927-	6.58
CP7717-2/217-BU	O-RING, BUNA-N	4.94	CP7979	SCREW,BRASS	3.12
CP7717-2/218-VI	O-RING, VITON, AA155	8.25	CP7985	WASHER,BRASS, 12-	3.86
CP7717-2/22-VI	O-RING, VITON	4.13	CP7991-IZP	WASHER,STL PLATED 44	2.30
CP7717-2/222-VI	O-RING, VITON	6.26	CP7991-SS	WASHER ST.STL,44	1.67
CP7717-2/226-BU	O-RING, BUNA-N	8.69	CP7998-7/8	NIPPLE BRASS,13075	20.76
CP7717-2/226-EPR	O-RING BLACK W/PURPLE DOT ETHY.PROP	8.38	CP8012-1/2-SS	COTTER PIN,SS,#17-	2.37
CP7717-2/226-VI	O-RING, VITON, 124 STR	17.84	CP8027-1-NYB	TEEJET CAP,NYLON	1.78
CP7717-2/228-EPR	O-RING, EPDM, AA126ML-F50	3.34	CP8027-NY	TEEJET CAP,WHITE,NY	1.40
CP7717-2/228-VI	O-RING, VITON, AA126ML-F50	8.43	CP8027-NYB	TEEJET CAP,BLACK,NY	1.40
CP7717-2/326/90-BU	O-RING, BUNA-N	8.03	CP8028-NYB	TEEJET BODY,NYLON,BLACK	2.43
CP7717-3-912-VI	O-RING, VITON	8.25	CP8037	1/8 DIA.RIVET, BRASS	2.30
CP7717-3-BU	O-RING, BUNA-N	7.90	CP8037-AL	1/8 DIA.RIVET, ALUM.	2.30
CP7717-3-EPR	O-RING, EPR	9.61	CP8038-SS	RIVET, SS TYPE 18-8	2.37
CP7717-3-VI	O-RING,VITON,36	10.19	CP8057-NYB	BODY, NYLON, 7421-	5.86
CP7717-4-VI	O-RING, VITON	6.86	CP8108	TEEJET BODY,LONG,BR.	11.82
CP7717-5-718-VI	O-RING, VITON	10.90	CP8122-1-NYB	TEEJET BODY,NYL,8120	11.61
CP7717-5-BU	O-RING, BUNA-N	6.60	CP8122-NYB	TEEJET BODY,NYL,8120	11.61
CP7717-5-EPR	O-RING, EPR	3.67	CP8123-1-NYB	TEEJET BODY,NYL,8121	11.61
CP7717-5-VI	O-RING, VITON	7.80	CP8123-NYB	TEEJET BODY,NYL,8121	11.61
CP7717-7-BU	O-RING, BUNA-N	7.08	CP8149-PL	HANDLE BALL,PLASTIC	6.73

PART NO.	DESCRIPTION	U.S.DOLLARS	PART NO.	DESCRIPTION	U.S.DOLLARS
CP8214-1-SS	STEM ASB,SS,8180A	68.22	CP8836-304SS	CLAMP,304SS,8370	14.06
CP8267	TEEJET ADAPTER, BR.	10.72	CP8836-IZP	CLAMP,STL-PLTD,8370	11.06
CP8295-1-NYB	BODY,NYL,8360	15.84	CP8837-304SS	STRAP,304SS,8370	26.10
CP8295-1/4-NYB	1/4"DIAPHRAGM BODY	15.84	CP8837-IZP	STRAP,STL-PLTD,8370	16.52
CP8295-NYB	BODY,NYL,8360	15.84	CP9001	FERRULE, BRASS,9527-	12.81
CP8296-1/4-NYB	BODY NYLON,8355-1/4	26.78	CP9001-SS	FERRULE,SS,25A-8980	48.56
CP8296-1/8-NYB	BODY NYLON,8355-1/8	24.68	CP9017-IZP	BODY CLAMP PLATE,IZP	11.33
CP8327-1/2	BODY,BR,8370-SPLT-EY	11.79	CP9029-IZP	CAM LEVER,STL-PLTD.	7.90
CP8327-1/2-SS	BODY,SS,8370-SPLT-EY	36.85	CP9032-1-BRSS	STEM ASB,BR.& SS,31-	9.13
CP8327-1/4	BODY,BR,8370-SPLT-EY	11.79	CP9032-1-SS	STEM ASB,ST.STL.,31-	15.80
CP8327-1/4-SS	BODY,SS,8370-SPLT-EY	36.85	CP9033-INP	TRIGGER,STL-PLTD.,31	12.46
CP8327-1/8	BODY,BR,8370-SPLT-EY	11.00	CP9034-1-IZP	SCR.HOUSNG,STL-PL,31	3.79
CP8327-1/8-SS	BODY,SS,8370-SPLT-EY	34.68	CP9034-2-IZP	SCREW,STL-PLD,31-	2.36
CP8327-3/8	BODY,BR,8370-SPLT-EY	11.79	CP9035	LOCKNUT,BRASS	2.36
CP8327-3/8-SS	BODY,SS,8370-SPLT-EY	36.85	CP9036	NUT,BRASS	7.02
CP8328-BU	GASKET,BUNA-N,	3.18	CP9036-ENP	NUT, BRASS-PLTD	8.72
CP8345-1-CTEF	VALVE SEAT,C.TEF,36	20.95	CP9062	BODY,BRASS, #31-	74.10
CP8345-NY	VALVE SEAT,NYLON,#3-	7.54	CP9062-1	BODY,BRASS,31-1/4F	63.18
CP8361-1/2-NYB	BODY,NYLON 8460-1/2	22.14	CP9062-3	BODY,BRASS,31TL-	63.18
CP8361-3/4-NYB	BODY,NYLON 8460-3/4	22.14	CP9062-4	BODY,BRASS,31TL-1/4F	63.18
CP8362-AL	BONNET,AL,8460-	31.53	CP9062-5	BODY,BRASS, #31-	63.18
CP8364-NYB	SEAT,NYLON,8460-PRV	6.86	CP9108-304SS	LOCK WIRE,304SS,31TL	6.44
CP8365-304SS	STOP RING,304SS,8460	6.95	CP9133	ADAPTER,BRASS	11.63
CP8366-FA	DIAPHRAGM,FAIRPRENE	7.20	CP9134-302SS	SPRING 302SS,#31	3.64
CP8367-AL	GUIDE SLEEVE,AL,9840	11.38	CP9172-302SS	SPRING 302SS,31-9290	2.81
CP8368-SS	ADJ.NUT,SS,8460-	11.99	CP9181-SS	TEEJET BODY,SS,9191-	29.15
CP8369-NYB	WASHER,NYLON,8460-	4.32	CP9182-SS	HOSE SHANK, SS ,9192	19.22
CP8371-AL	SPR.RETAINER,8460-	6.15	CP9183-SS	HOSE SHANK, SS ,9191	19.22
CP8373-I	OUT.SPRING,8460	13.26	CP9246-1-DI	BODY,DUCT.IRON,9830	432.79
CP8374-I	INS.SPRING,8460	10.65	CP9246-3/4-DI	BODY,DUCT.IRON,9830	432.79
CP8375-304SS	STRAP,304SS,8370	11.89	CP9247-DI	CAP,DUCT.IRON,9830-	106.96
CP8375-IZP	STRAP,STL-PLTD, 8370	6.73	CP9248-BU	GASKET,BUNA-N,9830-	4.87
CP8376-304SS	CLAMP,304SS,8370	11.72	CP9421-INP	SFTY SCRW,STL-PLD.25	12.21
CP8376-IZP	CLAMP,STL-PLTD, 8370	7.90	CP9423-I	SOCKET SETSCREW STL.	4.44
CP8389-304SS	CHAMBER INSERT,304SS	10.08	CP9424-SS	SPR.ADJ,SCREW,SS,25-	19.41
CP8394-Q-4010-BU	QUAD RING, BUNA-N	7.44	CP9427-AL	STOP ROD,ALUM,25-	7.69
CP8394-Q-4111-BU	QUAD RINGS,BUNA-N	7.13	CP9489-SS	SPRING,SS,9489-P.R.V	7.52
CP8394-Q-4347-VI	QUAD RING, VITON	121.37	CP9524-R	HAND GRIP,RUBBER	9.32
CP8427-304SS	WASHER,304SS,3DIRCTV	4.11	CP9528-1/16-IZP	ALLEN WRENCH	7.13
CP8477-IZP	SCREW STEEL-PLTD.	2.30	CP9539-INP	TRGGR GUARD,ST-PL,24	11.06
CP8477-SS	SCREW ST. STL.	2.30	CP9593-416SS	CAP,416SS,4 DIRECTVL	18.25
CP8478-SSP	TRIGGER,SS-POLISH,25	24.10	CP9608-SSP	INLT.BODY,SS-POL.	200.01
CP8498-2-SS	BODY,ST.STL,UNMARKED	40.52	CP9633-AL	SEAT PLG.GASKET44AUA	5.41
CP8525-1-430SS	SHORT STUD FOR 8600	5.70	CP9641-INP	STEM NUT,STL-PLTD,44	8.37
CP8525-2-430SS	LONG STUD FOR 8600	5.98	CP9697-SS	SELF-TAP SCREW,SS	3.26
CP8527-NY	BODY,NYLON, 8600-	6.58	CP9736-1/2	BODY,BRASS,9840-1/2	206.11
CP8528-NY	CAP NUT,NYLON, 8600-	6.54	CP9736-1/2-AL	BODY,ALUM.9840-1/2	108.31
CP8535-IZP	1/4-20 HEX NUT IZP	2.30	CP9736-1/2-DI	BDY,D.IRON,9840-1/2	180.80
CP8535-SS	1/4-20 HEX.NUT,SS	5.38	CP9736-3/4	BODY,BRASS,9840-3/4	206.11
CP8566-TEF	WASHER,TEFLON, 8600-	4.33	CP9736-3/4-AL	BODY,ALUM,9840-3/4	108.31
CP8591-IZP	TRIG.GUIDE,IZP,23L	2.81	CP9736-3/4-DI	BDY,D.IRON,9840-3/4	180.80
CP8592-AL	SPRING SCREW,ALUM,22	5.49	CP9778	BODY,BRASS,7421-CT	4.84
CP8593-SS	SPR.STUD,ST.STL	4.41	CP9778-SS	BODY,ST.STL,7421-CT	14.55
CP8631-NP	BODY,BRASS PLTD,8603	11.59	CP9813-CU	GSKT,COPPER,9717 STR	5.23
CP8633	BODY,BRASS,8604	11.59	CP9827-10-PP	CAP,POLYPROP,9360-	7.06
CP8633-NP	BODY,BRASS PLTD,8604	11.59	CP9827-15-PP	CAP,POLYPROP,9360-	7.06
CP8634	SUPPORT,BRASS,8603	5.00	CP9827-20-PP	CAP,POLYPROP,9360-	7.06
CP8635-NY	GASKET,NYLON,	2.30	CP9827-25-PP	CAP,POLYPROP,9360-	7.06
CP8679	OUTLET BODY,BR,7620-	11.06	CP9827-40-NY	CAP,NYLON, 9360-	7.06
CP8679-AL	OUTLET BODY,AL,7620-	11.06	CP9827-40-PP	CAP,POLYPROP,9360-	7.06
CP8834-304SS	CLAMP,304SS,8370	15.21	CP9827-42-PP	CAP,POLYPROP,9360-	7.06
CP8834-IZP	CLAMP,STL-PLTD,8370-	10.33	CP9827-5-PP	CAP,POLYPROP,9360-	7.06
CP8835-304SS	STRAP,304SS,8370	18.78	CP9827-50-PP	CAP,POLYPROP,9360-	7.06
CP8835-IZP	STRAP,STL-PLTD,8370	12.89	CP9827-60-PP	CAP,POLYPROP,9360-	7.06

PART NO.	DESCRIPTION	U.S.DOLLARS	PART NO.	DESCRIPTION	U.S.DOLLARS
CP9827-8-PP	CAP,POLYPROP,9360-	7.06	CP98515-PP	SPRING RETAINER	7.32
CP98455	INLET BODY, 1/4F NPT	23.69	CP98516-302SS	SPRING, 302SS	11.01
CP98455-1	INLET BODY, 1/4M NPT	23.69	CP98517-302SS	RETAINING PIN,302SS	3.48
CP98455-2	INLET BODY, 3/8M NPT	23.69	CP98522-SS	METRIC HEX NUT	4.05
CP98455-6	INLET BODY, 1/4M NPS	23.69	CP98523-SS	PAN HEAD SCREW	4.96
CP98455-7	INLET BODY, 3/8M NPS	23.69	CP98536	B BODY F/4664B CHECK VALVE, BRASS	37.60
CP98455-8	INLET BODY, 1/4M BSPP	23.69	CP98536-AL	ALUM BODY F/6446B CHECK VALVE	37.60
CP98455-9	INLET BODY, 3/8M BSPP	23.69	CP98542-NYB	98542 MALE QUICK CONNECT END CAP	20.43
CP98457	DBL OUTLET BODY	30.03	CP98578-1-NY	QJ CAP, LARGE, BLACK	2.13
CP98459	SINGLE OUTLET BODY	28.76	CP98582-1-NYB	BODY NYLON 8360QJT W/ ARROW	7.02
CP98461	INLET BODY BLANK 98460-1, NO VALVE, BRASS	21.35	CP98583-2-1-SS	1" RAPID STOP ADP FOR QJ17560A SERIES	12.97
CP98461-1	INLET BODY, 1/4M NPT	21.35	CP98583-2-1/2-SS	1/2" RAPID STOP ADP FOR QJ17560A SERIES	12.97
CP98461-2	INLET BODY, 3/8M NPT	21.35	CP98583-2-3/4-SS	3/4" RAPID STOP ADP FOR QJ17560A SERIES	12.97
CP98461-6	INLET BODY, 1/4M NPS	21.35	CP98583-3-1-SS	1" RAPID STOP ADP FOR QJ360, QJ370 & QJ380 & QJS SERIES	12.97
CP98461-7	INLET BODY, 3/8M NPS	21.35	CP98583-3-1/2-SS	3-1/2 RAPID STOP ADAPTER QJ370C SERIES 1/2" 303SS	12.97
CP98461-8	INLET BODY, 1/4M BSPP	21.35	CP98583-3-3/4-SS	3/4" RAPID STOP ADP FOR QJ360, QJ370, QJ380 & QJS SERIES	12.97
CP98461-9	INLET BODY, 3/8M BSPP	21.35	CP9897	GUIDE SEAT, BR,6815G	25.42
CP98462-302SS	SPRING,302	1.92	CP9897-AL	GUIDE SEAT, AL,6815G	25.42
CP98463	POSITIONING PIN,BRASS	4.83	CP9897-HSS	GUIDE SEAT,6815G	77.68
CP98464	SET SCREW,BRASS	2.21	CP9918-AHSS	CORE INSRT,HSS,12430	11.05
CP98467-PVC	SLEEVE SEAL, FLEXIBLE PVC	1.82	CP9918-TC	CORE INSERT,TC,12430	58.11
CP98468	LOCKING SCREW, BRASS	2.33	CP9983-NP	SAFE.LOCK CAP,BR-PLT	15.80
CP98469	#98469 1/4-18 NPS LOCK NUT, BRASS	8.16	CP9984-IZP	SNAP RING,STEEL-PLTD	6.73
CP98469-1	LOCK NUT, 3/8 NPS	8.16	CP9985-IENP	LOCK SCREW,STL-PLTD	15.80
CP98469-2	#98469-2 1/4-19 BSPP, LOCK NUT, BRASS	8.16	CPB116241-1-1/4-NYB	BOLTED FLANGE GAUGE PT 1/4 BSPT	20.43
CP98469-3	LOCK NUT, 3/8 BSPP	8.16	CPB116241-1-3/8-NYB	BOLTED FLANGE GAUGE PT 3/8 BSPT	20.43
CP98472-CE	3/4" SPLIT EYELET BODY QJ380F	7.43	CPB11893	BODY,BR.,110-1,BSPT	196.95
CP98474-NYB	QJ383 TURRET	10.53	CPB11893-AL	BODY ALUM BSPT	83.53
CP98475-NYB	QJ380 PLUG	3.43	CPB11902	INL.ADAPTR,BR,BSPT	54.90
CP98476-CE	QJ380 3/4" SPLIT EYELET BODY	24.59	CPB11902-AL	INL ADAPTR,AL,BSPT	47.01
CP98477-CE	QJ380 1" SPLIT EYELET BODY	24.59	CPB11902-I	INL.ADAPTR,IRON,BSPT	47.01
CP98479-VI	QJ380 SEAL, VITON	13.00	CPB11905-AL	BODY BSPT ALUM	99.93
CP98484-VI	DIAPHRAGM, VITON	7.87	CPB11908-AL	INLET ADAP,BSPT ALUM	58.65
CP98488-VI	NOZZLE BODY INLET ADAPTER SEAL	9.85	CPB12094-NYB	TEEJET BODY, BSPT BLACK NYLON	2.37
CP98490-NYB	BOLTED FLANGE X #75	20.43	CPB12287-1/1/2-AL	STR.HEAD,BSPT,AL,124	169.90
CP98491-PP	BOLTED FLANGED X #50	20.43	CPB12287-1/1/2-I	HEAD,BSPT,C.IRON,124	208.88
CP98492-1-1/2-PP	BOLTED FLANGED X 1-1/2" NPT	20.43	CPB12287-1/1/4-AL	STR.HEAD,BSPT,AL,124	169.90
CP98493-1-1/4-PP	BOLTED FLANGED X 1-1/4" NPT	20.43	CPB12287-1/1/4-I	HEAD,BSPT,C.IRON,124	208.88
CP98496-PP	MALE BOLTED FLANGED ADPT 4816	23.52	CPB1321	TEEJET BODY,BSPT,BR.	3.40
CP98497-PP	MALE LQC BOLTED FLANGED AD	20.43	CPB1321-SS	TEEJET BODY,BSPT,SS	22.35
CP98498-SS	430 ACC MTG BRACKET	28.00	CPB1322	TEEJET BODY,BSPT,BR.	3.40
CP98501-PP	FLANGE/BOLT 50 STR HD 430 ACC	18.10	CPB1322-SS	TEEJET BODY,BSPT,SS	22.35
CP98502-NYB	75 FLANGE FEMALE INLET ADAPTER 430	16.94	CPB1323	TEEJET BODY,BSPT,BR.	5.83
CP98503-NYB	75 FLANGE MALE INLET ADAPTER 430	16.94	CPB1323-SS	TEEJET BODY BSPT,SS.	27.74
CP98506-PP	344 BOLTED FLANGE ASSEM.	7.72	CPB1324	TEEJET BODY,BSPT,BR.	3.40
CP98507-PP	FLANGED T-BODY	19.01	CPB1324-SS	TEEJET BODY,BSPT,SS	22.35
CP98508-SS	ACORN NUT, M6X1X10MM	14.51	CPB1335	TEEJET BODY,BSPT,BR.	3.40
CP98509-SS	THREADED ROD,303SS	18.98	CPB1335-SS	TEEJET BODY,BSPT,SS	22.35
CP98511-NYB	VALVE BODY, POLYPRO	56.07	CPB13353	ADAPTER #13340 BS	18.20
CP98511-PP	VALVE BODY, POLYPRO	56.07	CPB1336	TEEJET BODY,BSPT,BR.	3.40
CP98512-NY	ADJUSTING CAP	10.97	CPB1336-SS	TEEJET BODY,BSPT,SS	22.35
CP98512-PP	ADJUSTING CAP	10.97	CPB1339	TEEJET BODY,BSPT,BR.	12.32
CP98513-PP	LOCKRING, POLYPRO	3.35			
CP98514-NYB	98510 Pressure Relief Valve 430 acc. Manifold	3.35			
CP98514-PP	GUIDE SEAT, POLYPRO	3.35			
CP98515-NYB	SPRING REATINER, POLYPRO 4816	7.32			

PART NO.	DESCRIPTION	U.S.DOLLARS	PART NO.	DESCRIPTION	U.S.DOLLARS
CPB1339-SS	TEEJET BODY,SS,BSPT	63.72	CPB2627	BODY,BSPT,BRSS,1/4BB	21.43
CPB1340	TEEJET BODY BSPT.BR.	12.32	CPB26484	INL.CYL.1/4M,BSPT	39.07
CPB1340-SS	TEEJET BODY BSPT.SS.	59.86	CPB3598	BDY.BSPT.BRSS,1/8AB	17.11
CPB14632-2-AL	HEAD,AL.124AL-2,BSPT	351.32	CPB36303-PP	BODY,PP,BSPT	24.78
CPB14632-2-I	HEAD IRON BSPT.124-2	328.59	CPB37548-PP	1"THREADED INL.BSPT	12.67
CPB14632-2/1/2-AL	HEAD ALUM. BSPT.124	351.32	CPB37684-PP	1/4 TREADED INLET	12.67
CPB14632-2/1/2-I	HEAD,IRON BSPT.124	328.59	CPB37687-PP	3/8 THREADED INLET	12.67
CPB14801-PP	BODY POLYPRO.BSPT.	22.14	CPB3818	BODY,BR,3/4TT,BSPT	27.54
CPB15240-1-SS	INLET BDY,SUB.BSPT	177.70	CPB39537-1-CE	1/8" CAP BSPT	21.14
CPB15402-1-AL	HEAD ALUM,BSPT,124A	95.99	CPB4145-1	INLET,BSPT,4202,BR	10.96
CPB15402-1-I	HEAD,IRON,BSPT, 124A	130.14	CPB4215-1	CONN.BODY,4203,BSPT	8.47
CPB15402-3/4-AL	HEAD ALUM,BSPT,124A	95.99	CPB45101-1/2-PP	1/2" BSPT ML STRAINER HEAD, PP	13.30
CPB15402-3/4-I	HEAD,IRON,BSPT,124A	130.14	CPB45101-3/4-PP	3/4" BSPT 122ML STRAINER HEAD, PP	13.30
CPB17112-IENP	ADPTR,BSPT,IENP	16.24	CPB45508-1/4-PP	#50XB1/4 IN PTF	3.84
CPB17113-IENP	ADPTR,BSPT,STL-PLTD	16.24	CPB45512-PP	#50XB1-1/4	3.84
CPB18671-NYB	BODY, QJB8360 BSPT	6.21	CPB45539-3/8-PP	#50XB3/8 IN PTF	3.84
CPB18676-1/4-NYB	BODY NYLON,BSPT	11.22	CPB46027-NYB	1/2 BSPT INLET COVER	12.94
CPB18676-1/8-NYB	BODY NYLON,BSPT	11.22	CPB46066-PP	#75XB1-1/2 IN PTF	9.53
CPB19342-1-AL	STR.HEAD,BSPT,ALUM.	109.53	CPB46127-1/4-PP	INLET, 480	9.53
CPB19342-3/4-AL	STR.HEAD,124ML,AL	109.53	CPB46127-3/8-PP	INLET, 480 BSPT	9.53
CPB19345-11/2-AL	STRAINER HEAD BSPT	187.49	CPB46145-1/4-NY	1/4 BSPT QUICK TEEJET CAP F/ QJ4676, NY BLACK	2.91
CPB19345-11/4-AL	STR.HEAD,124ML,ALUM.	187.49	CPB46145-1/8-NY	1/8 BSPT QUICK TEEJET CAP F/ QJ4676, NY BLACK	2.91
CPB19348-2-AL	STR.HEAD,124ML,BSPT	394.25	CPB4682-1	TRIGER TEJT BDY BSPT	56.72
CPB19804	INLET BODY,BSPT.BR.	39.85	CPB48154-PP	#50XB1 IN PTF	3.44
CPB20102-1-NYB	BODY 3 WAY BSPT.344E	66.62	CPB48155-PP	#50XB1 IN PTM	3.44
CPB20102-3/4-NYB	BODY 3 WAY BSPT.344E	66.62	CPB48156-PP	#50XB1-1/2 PTM	3.71
CPB20104-1-NYB	END CAP BSPT.344E NY	30.16	CPB48159-PP	50 X B3/4" PTF	3.44
CPB20104-1-PP	END CAP POLYPRO.BSPT	30.16	CPB48165-PP	#75XB1-1/4 IN PTM	6.99
CPB20104-3/4-NYB	END CAP BSPT.344E NY	30.16	CPB48166-PP	#75XB1-1/2 IN PTM	6.99
CPB20104-3/4-PP	END CAP POLYPRO.BSPT	30.16	CPB48167-PP	#75XB2 IN PTM	6.99
CPB21034-AL	BYPASS ADAPTERBSPT	89.57	CPB48172-PP	#50XB3/4 IN PTM	3.44
CPB21112-SS	BODY SUB-ASB.ST.STL	287.61	CPB48654-PP	LARGE BOWL GRAY-PP- BSPT	36.54
CPB21672-1-PPB	BODY,PP,144-1-3,BSPT	41.80	CPB4928-SS	ADAPTER,ST.STL,BSPT	28.80
CPB22136	BODY BRASS BSPT.30L	45.85	CPB50492-1-PP	1" BSPT STRAINER HEAD-PP	18.10
CPB22406-PP	BYPASS ADAPTER BSPT	27.70	CPB50492-3/4-PP	3/4" BSPT STRAINER. HEAD-PP	18.10
CPB22654-PP	HANDLE POLYPRO.22650	8.37	CPB50493-PP	MEDIUM STRAINER BOWL GRAY-PP- BSPT	17.86
CPB22707-1/2-PP	END CAP,POLYPRO,BSPT	21.77	CPB56719-PPB	AIR CV INLET CAP BSPT	4.70
CPB22707-3/8-PP	END CAP,POLYPRO,BSPT	21.77	CPB58473-NYB	LQC X 3/4" BSPT F	20.56
CPB22836-NYB	BYPASS ADAP.BSPT. BLACK NYLON	32.13	CPB58473-PP	LQC X 3/4" BSPT F	20.56
CPB23121-PP	BODY PP 23120 BSPT 3/4"	31.29	CPB58474-NYB	LQC X 1" BSPT F	20.56
CPB23128-PP	1/2" BODY,BSPT 23120	31.29	CPB58474-PP	LQC X 1" BSPT F	20.56
CPB23171-1/2-PP	1/2"BSPT STRAINER.HEAD BSPT. PP	12.30	CPB58475-NYB	LQC X 1-1/4" BSPT F	20.56
CPB23171-3/4-PP	3/4"BSPT STRAINER.HEAD BSPT. PP	12.30	CPB58475-PP	LQC X 1-1/4" BSPT F	20.56
CPB23442-PP	INLET BODY BSPT.PP	7.47	CPB58476-PP	LQC X 1-1/2" BSPT F	20.56
CPB23547-PP	BODY 3 WAY 1-1/4,PP.	68.53	CPB58478-NYB	LQC X 1/4" GAUGE PORT BSPT F	20.56
CPB23548-PP	BODY 3 WAY 1-1/2,PP.	68.53	CPB58478-PP	LQC GAUGE PT BSPT	20.56
CPB23551-PP	END CAP 1-1/2,POLYP.	31.54	CPB5850-1/2	BODY,BSPT,1/2ATW-B	100.76
CPB23552-PP	END CAP 1-1/4,POLYP.	31.54	CPB5850-1/2-AL	1/2 BODY,1/2ATW BSPT	63.35
CPB2384-1	BODY,BSPT,BR,1TW-B	484.93	CPB5850-3/4	BODY,BSPT,3/4ATW-B	100.76
CPB2384-1-AL	BODY,AL.,1TWAL BSPT	158.06	CPB5850-3/4-AL	3/4 BODY,ALUM.3/4ATW	63.35
CPB2384-1-I	BODY,BSPT,IRON,1TW	162.63	CPB6302	BODY,BRAS,6290 J BST	44.07
CPB2384-3/4	BODY,BSPT,BR,3/4TW-B	484.93	CPB63065-1-1/4-PP	1-1/4" BSPT STRAINER HEAD-PP	36.91
CPB2384-3/4-I	BODY,BSPT,STL,3/4TW-	156.65	CPB63066-1-1/2-PP	1-1/2" BSPT STRAINER HEAD-PP	36.91
CPB2386-11/2	BODY,BSPT.1-1/2TW-B	1025.38	CPB6492	GUNJET BODY,1/2",43	65.44
CPB2386-11/2-I	BODY,BSPT.CAST-IRON	383.60	CPB6492-AL	INLT BODY,42&43,BSPT	45.66
CPB2386-11/4	BODY,BSPT,BR,1-1/4	1025.38	CPB6524	6240 INLET BODY BSPT	11.39
CPB2386-11/4-I	BODY,BSPT,IRON,1-1/4	383.60	CPB6818-1/2	BODY BSPT, 6815-1/2	89.09
CPB2388-2	BODY,BSPT,BR,2TW-B	1850.54	CPB6818-3/4	BODY BSPT, 6815-3/4	89.09
CPB2388-2-I	BODY,BSPT,C.IRON,2TW	701.06	CPB7059	INLET ADAPT.BSPT.BR.	15.10
CPB2388-21/2	BODY,BSPT,BR,2-1/2	1782.20	CPB7059-ALEF	INLET ADAPT.BSPT.AL.	15.10
CPB2388-21/2-I	BODY,BSPT,IRON,2-1/2	701.06			

PART NO.	DESCRIPTION	U.S.DOLLARS	PART NO.	DESCRIPTION	U.S.DOLLARS
CPB7220	OUTLET BODY,BR. BSPT	7.32	D16	ORIFICE DISC,HARD.SS	2.26
CPB7220-1	INLET BODY,BR. BSPT	7.32	D2	ORIFICE DISC,HARD.SS	2.26
CPB7451-2	INLT BODY,BSPT,7450B	7.26	D25143-UB-850050	UND.LEAF BAND NOZ BR	22.16
CPB7452-1	INLET BODY,BR762 BST	7.01	D25143-UB-850050-SS	UND.LEAF BAND NOZ SS	42.15
CPB7528	BODY BR.BSPT 7521-	7.90	D25143-UB-850075	UND.LEAF BAND NOZ.BR	22.16
CPB7528-SS	BODY SS.BSPT.7521-	14.55	D25143-UB-850075-SS	UND.LEAF BAND NOZ.SS	42.15
CPB7529	BODY BR,BSPT,7521-	7.90	D25143-UB-8501	UND.LEAF BAND NOZ.BR	22.16
CPB7529-SS	BODY SS.BSPT.7521-	14.55	D25143-UB-8501-SS	UND.LEAF BAND NOZ.SS	42.15
CPB8296-1/4-NYB	BODY NYLON,BSPT,8355	27.69	D25143-UB-85015	UND.LEAF BAND NOZ.BR	22.16
CPB8296-1/8-NYB	BODY NYLON,BSPT,8355	25.47	D25143-UB-85015-SS	UND.LEAF BAND NOZ.SS	42.15
CPB8327-1/4	BODY BR.BSPT.8370-	12.24	D25143-UB-8502	UND.LEAF BAND NOZ.BR	22.16
CPB8327-3/8	BODY BR.BSPT.8370-	12.24	D25143-UB-8502-SS	UND.LEAF BAND NOZ.SS	42.15
CPB9246-1-DI	BODY 9830 DUCT I BST	446.21	D25143-UB-8503	UND.LEAF BAND NOZ.BR	22.16
CPB9736-3/4	3/4 BODY BSPT 9840	212.42	D25143-UB-8503-SS	UND.LEAF BAND NOZ.SS	42.15
CPB98455-3	1/4 FEMALE INLET BODY,BRASS-BSPT	23.69	D25143-UB-8504	UND.LEAF BAND NOZ.BR	22.16
CPB98455-4	1/4 MALE INLET BODY, BRASS-BSPT	23.69	D25143-UB-8504-SS	UND.LEAF BAND NOZ.SS	42.15
CPB98455-5	3/8 MALE INLET BODY, BRASS-BSPT	23.69	D25143-UB-8505	UND.LEAF BAND NOZ.BR	22.16
CPB98461-3	INLET BODY, 1/4F BSPT	21.35	D25143-UB-8505-SS	UND.LEAF BAND NOZ.SS	42.15
CPB98461-4	INLET BODY, 1/4M BSPT	21.35	D25143-UB-8506	UND.LEAF BAND NOZ.BR	22.16
CPB98461-5	INLET BODY, 3/8M BSPT	21.35	D25143-UB-8506-SS	UND.LEAF BAND NOZ.SS	42.15
CPB98492-1-1/2-PP	BOLTED FLANGED X 1-1/2" BSPT	20.43	D26-F75	26MM D SERIES FM F75 FLOW METER	1129.89
CPB98493-1-1/4-PP	BOLTED FLANGED X 1-1/4" BSPT	20.43	D3	ORIFICE DISC,HARD.SS	2.26
CPP12287-1/1/2-AL	HEAD,BSPP,ALUM,124	169.90	D4	ORIFICE DISC,HARD.SS	2.26
CPP12287-1/1/2-I	HEAD,BSPP,IRON,124-	208.88	D41892-1/2-POM-6	TANK RINSING NOZZLE, D41892E-1/2-POM-6	272.62
CPP12287-1/1/4-AL	HEAD,BSPP,ALUM,124	169.90	D41892-3/8-POM-6	TANK RINSING NOZZLE	272.62
CPP12287-1/1/4-I	HEAD,BSPP,IRON,124-	208.88	D41892-B1/2-POM-6	TANK RINSING NOZZLE, D41892E-B1/2-POM-6	272.62
CPP14761-3/8	TEEJET CAP BR.,BSPP	2.41	D41892-B3/8-POM-6	TANK RINSING NOZZLE	272.62
CPP14761-3/8-SS	TEEJET CAP SS.,BSPP	13.36	D5	ORIFICE DISC,HARD.SS	2.26
CPP15402-1-AL	HEAD ALUM,BSPP,124A	95.99	D6	ORIFICE DISC,HARD.SS	2.26
CPP15402-1-I	HEAD,IRON,BSPP,124A	130.14	D7	ORIFICE DISC,HARD.SS	2.26
CPP15402-3/4-AL	HEAD ALUM,BSPP, 124A	95.99	D8	ORIFICE DISC,HARD.SS	2.26
CPP15402-3/4-I	HEAD,IRON,BSPP,124A	130.14	DC13	TEEJET CORE.BRASS	3.90
CPP19012-NYB	BODY BSPP,19011	22.31	DC13-CER	CORE CERAMIC	9.36
CPP45508-1/4-PP	#50XP1/4 IN PTF	3.84	DC13-HSS	TEEJET CORE,HARD SS	9.29
CPP45508-NYB	1/4 INLET COVER,BSPP	12.94	DC13-NY	TEEJET CORE NYLON, ORANGE	2.04
CPP45539-3/8-PP	#50XP3/8 IN PTF	3.84	DC23	TEEJET CORE.BRASS	3.90
CT1550-PP	CLIP EYELET TIP PP	6.60	DC23-CER	CORE CERAMIC	9.36
CT2530-PP	CLIP EYELET TIP PP	6.60	DC23-HSS	TEEJET CORE,HARD SS	9.29
CT2560-PP	CLIP EYELET TIP PP	6.60	DC23-NY	TEEJET CORE-NYLON, GREEN	2.04
CT4020-PP	CLIP EYELET TIP PP	6.60	DC25	TEEJET CORE.BRASS	3.90
CT4030-PP	CLIP EYELET TIP PP	6.60	DC25-CER	CORE CERAMIC	9.36
CT4040-PP	CLIP EYELET TIP PP	6.60	DC25-HSS	TEEJET CORE,HARD SS	9.29
CT4050-PP	CLIP EYELET TIP PP	6.60	DC25-NY	TEEJET CORE NYLON, YELLOW	2.04
CT5020-PP	CLIP EYELET TIP PP	6.60	DC31	TEEJET CORE.BRASS	3.90
CT5030-PP	CLIP EYELET TIP PP	6.60	DC31-CER	CORE CERAMIC	9.36
CT5040-PP	CLIP EYELET TIP PP	6.60	DC31-HSS	TEEJET CORE,HARD.SS	9.29
CT5050-PP	CLIP EYELET TIP PP	6.60	DC31-NY	TEEJET CORE NYLON, WHITE	2.04
CT5070-PP	CLIP EYELET TIP PP	6.60	DC33	TEEJET CORE.BRASS	3.90
CT6510-PP	CLIP EYELET TIP PP	6.60	DC33-CER	CORE CERAMIC	9.36
CT6520-PP	CLIP EYELET TIP PP	6.60	DC33-HSS	TEEJET CORE,HARD SS	9.29
CT6530-PP	CLIP EYELET TIP PP	6.60	DC33-NY	TEEJET CORE NYLON, RED	2.04
CT6540-PP	CLIP EYELET TIP PP	6.60	DC35	TEEJET CORE.BRASS	3.90
CT6550-PP	CLIP EYELET TIP PP	6.60	DC35-CER	CORE CERAMIC	9.36
CT8010-PP	CLIP EYELET TIP PP	6.60	DC35-HSS	TEEJET CORE,HARD SS	9.29
CT8040-PP	CLIP EYELET TIP PP	6.60	DC35-NY	TEEJET CORE NYLON, BROWN	2.04
CTPLUG	CLIP EYELET TIP PLUG	9.17	DC45	TEEJET CORE.BRASS	3.90
D1	ORIFICE DISC,HARD.SS	2.26	DC45-CER	CORE CERAMIC	9.36
D1.5	ORIFICE DISC,HARD.SS	2.26	DC45-HSS	TEEJET CORE,HARD SS	9.29
D10	ORIFICE DISC,HARD.SS	2.26	DC45-NY	TEEJET CORE NYLON, GRAY	2.04
D12	ORIFICE DISC,HARD.SS	2.26	DC46	TEEJET CORE.BRASS	3.90
D14	ORIFICE DISC,HARD.SS	2.26	DC46-CER	CORE CERAMIC	9.36

PART NO.	DESCRIPTION	U.S.DOLLARS	PART NO.	DESCRIPTION	U.S.DOLLARS
DC46-HSS	TEEJET CORE,HARD SS	9.29	DJ-08-10	DYNAJET KIT - 08 CAPACITY	416.95
DC46-NY	TEEJET CORE NYLON, BLUE	2.04	DJ-10-10	DYNAJET KIT - 10 CAPACITY	416.95
DC56	TEEJET CORE.BRASS	3.90	DOC-14	DOCJET TIP NOZ,BRASS	72.66
DC56-CER	CORE CERAMIC	9.36	DOC-21	DOCJET TIP NOZ,BRASS	72.66
DC56-HSS	TEEJET CORE,HARD SS	9.29	DOC-32	DOCJET TIP NOZ,BRASS	72.66
DC56-NY	TEEJET CORE NYLON, BLACK	2.04	DOC-48	DOCJET TIP NOZ,BRASS	72.66
DCER-1	ORIF.INSERT,CERAMIC	6.17	DOC-72	DOCJET TIP NOZ,BRASS	72.66
DCER-10	ORIF.INSERT,CERAMIC	6.17	DVP-2	ORIFICE DISC/ORANGE	1.45
DCER-2	ORIF.INSERT,CERAMIC	6.17	DVP-3	ORIFICE DISC/GREEN	1.45
DCER-3	ORIF.INSERT,CERAMIC	6.17	DVP-4	ORIFICE DISC/YELLOW	1.45
DCER-4	ORIF.INSERT,CERAMIC	6.17	DVP-5	ORIFICE DISC/BLUE	1.45
DCER-5	ORIF.INSERT,CERAMIC	6.17	DVP-6	ORIFICE DISC/RED	1.45
DCER-6	ORIF.INSERT,CERAMIC	6.17	DVP-7	ORIFICE DISC/BROWN	1.45
DCER-7	ORIF.INSERT,CERAMIC	6.17	DVP-8	ORIFICE DISC/GREY	1.45
DCER-8	ORIF.INSERT,CERAMIC	6.17	DX-10	ORIFICE TIP,BRASS	20.47
DDOC-144	DOCJET TIP,BRASS	85.36	DX-12	ORIFICE TIP,BRASS	20.47
DDOC-28	DOCJET TIP,BRASS	85.36	DX-14	ORIFICE TIP,BRASS	20.47
DDOC-42	DOCJET TIP,BRASS	85.36	DX-16	ORIFICE TIP,BRASS	20.47
DDOC-64	DOCJET TIP,BRASS	85.36	DX-6	ORIFICE TIP,BRASS	20.47
DDOC-96	DOCJET TIP,BRASS	85.36	DX-8	ORIFICE TIP,BRASS	20.47
DE1	ORIFICE DISC,ST.STL.	2.04	DX-HSS10	ORIFICE TIP,H.STL	36.78
DE1.5	ORIFICE DISC, 302 ST.STL.	2.04	DX-HSS12	ORIFICE TIP,H.STL	36.78
DE10	ORIFICE DISC,ST.STL.	2.04	DX-HSS14	ORIFICE TIP,H.STL	36.78
DE12	ORIFICE DISC,ST.STL.	2.04	DX-HSS16	ORIFICE TIP,H.STL	36.78
DE14	ORIFICE DISC ST.STL.	2.04	DX-HSS5	ORIFICE TIP,H.STL	36.78
DE16	ORIFICE DISC,ST.STL.	2.04	DX-HSS6	ORIFICE TIP,H.STL	36.78
DE2	ORIFICE DISC,ST.STL.	2.04	DX-HSS8	ORIFICE TIP,H.STL	36.78
DE3	ORIFICE DISC,ST.STL.	2.04	ECS17560A-1-NYB	SPL EYL W E-CHMSVR	266.94
DE4	ORIFICE DISC,ST.STL.	2.04	ECS17560A-1/2-NYB	SPL EYL W E-CHMSVR	266.94
DE5	ORIFICE DISC,ST.STL.	2.04	ECS17560A-1/2X7-NYB	SPL EYL W E-CHMSVR	266.94
DE6	ORIFICE DISC,ST.STL.	2.04	ECS17560A-20MM-NYB	SPL EYL W E-CHMSVR	266.94
DE7	ORIFICE DISC,ST.STL.	2.04	ECS17560A-20MMX7-NYB	SPL EYL W E-CHMSVR	266.94
DE8	ORIFICE DISC,ST.STL.	2.04	ECS17560A-25MM-NYB	SPL EYL W E-CHMSVR	266.94
DG110015-VP	POLYMER TEEJET TIP	8.63	ECS17560A-3/4-NYB	SPL EYL W E-CHMSVR	266.94
DG110015-VS	VISIFLO TEEJET TIP	14.44	ECS24216A-1-NYB	TURRET W E-CHMSVR	280.06
DG11002-VP	POLYMER TEEJET TIP	8.63	ECS24216A-1/2-NYB	TURRET W E-CHMSVR	280.06
DG11002-VS	VISIFLO TEEJET TIP	14.44	ECS24216A-1/2M-NYB	TURRET W E-CHMSVR	280.06
DG11003-VP	POLYMER TEEJET TIP	8.63	ECS24216A-1/2X7-NYB	TURRET W E-CHMSVR	280.06
DG11003-VS	VISIFLO TEEJET TIP	14.44	ECS24216A-20MM-NYB	TURRET W E-CHMSVR	280.06
DG11004-VP	POLYMER TEEJET TIP	8.63	ECS24216A-20MMX7-NYB	TURRET W E-CHMSVR	280.06
DG11004-VS	VISIFLO TEEJET TIP	14.44	ECS24216A-3/4-NYB	TURRET W E-CHMSVR	280.06
DG11005-VP	POLYMER TEEJET TIP	8.63	ECS311-375-NYB	22251-311-375 W/ECS	285.21
DG11005-VS	VISIFLO TEEJET TIP	14.44	ECS311-500-NYB	22251-311-500 W/ECS	285.21
DG3003-SS	SPOT SPRAYING TEEJET TIP 303SS	17.51	ECS311-750-NYB	22251-311-750 W/ECS	285.21
DG3004-SS	SPOT SPRAYING TEEJET TIP 303SS	17.51	ECS312-375-NYB	22252-312-375 W/ECS	285.21
DG65055-SS	SPOT SPRAYING TEEJET TIP 303SS	17.51	ECS312-500-NYB	22252-312-500 W/ECS	285.21
DG80015VS	VISIFLO TEEJET TIP	14.44	ECS312-750-NYB	22252-312-750-W/ECS	285.21
DG8002VS	VISIFLO TEEJET TIP	14.44	ECS363C-1-NYB	360 3 OUTLET W/CHEM	296.22
DG8003VS	VISIFLO TEEJET TIP	14.44	ECS363C-1/2-NYB	360 3 OUTLET W/CHEM	111.24
DG8004VS	VISIFLO TEEJET TIP	14.44	ECS363C-1/2X7MM-NYB	360 3 OUTLET W/CHEM	296.22
DG8005VS	VISIFLO TEEJET TIP	14.44	ECS363C-25MM-NYB	360 3 OUTLET W/CHEM	296.22
DG95015EVS	VISIFLO TEEJET,EVEN	14.44	ECS363C-3/4-NYB	360 3 OUTLET W/CHEM	296.22
DG9502EVS	VISIFLO TEEJET,EVEN	14.44	ECS363E-20MM-NYB	360 3 OUTLET W/CHEM	296.22
DG9503EVS	VISIFLO TEEJET,EVEN	14.44	ECS364C-1-NYB	360 4 OUTLET W/CHEM	296.22
DG9504EVS	VISIFLO TEEJET,EVEN	14.44	ECS364C-1/2-NYB	360 4 OUTLET W/CHEM	296.22
DG9505EVS	VISIFLO TEEJET,EVEN	14.44	ECS364C-1/2X7MM-NYB	360 4 OUTLET W/CHEM	296.22
DGTJ60-110015VS	VISIFLO DG TWINJET	22.13	ECS364C-1/2X7MM-NYB	360 4 OUTLET W/CHEM	296.22
DGTJ60-11002VS	VISIFLO DG TWINJET	22.13	ECS364C-25MM-NYB	360 4 OUTLET W/CHEM	296.22
DGTJ60-11003VS	VISIFLO DG TWINJET	22.13	ECS364C-3/4-NYB	360 4 OUTLET W/CHEM	296.22
DGTJ60-11004VS	VISIFLO DG TWINJET	22.13	ECS364E-20MM-NYB	360 4 OUTLET W/CHEM	296.22
DGTJ60-11006VS	VISIFLO DG TWINJET	22.13	ECS365C-1-NYB	360 5 OUTLET W/CHEM	296.22
DGTJ60-11008VS	VISIFLO DG TWINJET	22.13	ECS365C-1/2-NYB	360 5 OUTLET W/CHEM	296.22
DJ-05-10	DYNAJET KIT - 05 CAPACITY	385.74	ECS365C-1/2X7MM-NYB	360 5 OUTLET W/CHEM	296.22
DJ-06-10	DYNAJET KIT - 06 CAPACITY	385.74	ECS365C-25MM-NYB	360 5 OUTLET W/CHEM	296.22
			ECS365C-3/4-NYB	360 5 OUTLET W/CHEM	296.22



PART NO.	DESCRIPTION	U.S.DOLLARS	PART NO.	DESCRIPTION	U.S.DOLLARS
ECS365E-20MM-NYB	360 5 OUTLET W/CHEM	296.22	H1/4U-SS0005	VEEJET NOZZLE, 303SS	21.43
ECS8360-NYB	QJ8360-NYB W/CHEM	283.11	H1/4U-SS0006	VEEJET NOZZLE, 303SS	21.43
ECSB8360-NYB	QJB8360-NYB W/CHEM	283.11	H1/4U-SS0008	VEEJET NOZZLE, 303SS	21.43
ECSQJ19011-NYB	QJP19011 W/55295-1-12 ECHEM	283.11	H1/4U-SS0010	VEEJET NOZZLE, 303SS	21.43
ECST8360-NYB	QJT8360-NYB W/CHEM	283.11	H1/4U-SS00100	VEEJET NOZZLE, 303SS	21.43
EFT24216A-1-EC-12	24216A VITON W/ 115880 ECS	280.06	H1/4U-SS0012	VEEJET NOZZLE, 303SS	21.43
EFT24216A-1/2-AC	24216A W/ 55300 AC	64.66	H1/4U-SS0015	VEEJET NOZZLE, 303SS	21.43
EFT24216A-1/2-EC-12	24216A VITON W/ 115880 ECS	280.06	H1/4U-SS0020	VEEJET NOZZLE, 303SS	21.43
EFT24216A-1/2M-EC-12	24216A VITON W/ 115880 ECS	280.06	H1/4U-SS0020G	VEEJET NOZZLE, SS, NPT	26.31
EFT24216A-20MM-EC-12	24216A VITON W/ 115880 ECS	280.06	H1/4U-SS0025	VEEJET NOZZLE, SS, NPT	21.43
EFT24216A-3/4-EC-12	24216A VITON W/ 115880 ECS	280.06	H1/4U-SS0030	VEEJET NOZZLE, 303SS	21.43
FL-10VC	VISIFLO FULLJT.SS&CE	11.31	H1/4U-SS0040	VEEJET NOZZLE, 303SS	21.43
FL-10VS	VISIFLO FULLJT.SS&CE	17.77	H1/4U-SS0050	VEEJET NOZZLE, 303SS	21.43
FL-15VC	VISIFLO FULLJT.SS&CE	11.31	H1/4U-SS0060	VEEJET NOZZLE, 303SS	21.43
FL-15VS	VISIFLO FULLJT.SS&CE	17.77	H1/4U-SS0070	VEEJET NOZZLE, 303SS	21.43
FL-5VC	VISIFLO FULLJT.SS&CE	11.31	H1/4U-SS0080	VEEJET NOZZLE, 303SS	21.43
FL-5VS	VISIFLO FULLJT.SS&CE	17.77	H1/4U-SS1510	VEEJET NOZZLE, 303SS	16.33
FL-6.5VC	VISIFLO FULLJT. CE	11.31	H1/4U-SS1515	VEEJET NOZZLE, 303SS	16.33
FL-6.5VS	VISIFLO FULLJT.SS&CE	17.77	H1/4U-SS1520	VEEJET NOZZLE, 303SS	16.33
FL-8VC	VISIFLO FULLJT.SS&CE	11.31	H1/4U-SS2510	VEEJET NOZZLE, 303SS	16.33
FL-8VS	VISIFLO FULLJT.SS&CE	17.77	H1/4U-SS2515	VEEJET NOZZLE, 303SS	16.33
H1/2U-25200	VEEJET NOZZLE,BRASS	40.53	H1/4U-SS2520	VEEJET NOZZLE, 303SS	16.33
H1/2U-65100	VEEJET NOZZLE,BRASS	40.53	H1/4U-SS4010	VEEJET NOZZLE, 303SS	16.33
H1/2U-65150	VEEJET NOZZLE,BRASS	40.53	H1/4U-SS4015	VEEJET NOZZLE, 303SS	16.33
H1/2U-65200	VEEJET NOZZLE,BRASS	40.53	H1/4U-SS4020	VEEJET NOZZLE, 303SS, NPT	16.33
H1/2U-80100	VEEJET NOZZLE,BRASS	40.53	H1/4U-SS5010	VEEJET NOZZLE, 303SS	16.33
H1/2U-80150	VEEJET NOZZLE,BRASS	40.53	H1/4U-SS5015	VEEJET NOZZLE, 303SS	16.33
H1/2U-80200	VEEJET NOZZLE,BRASS	40.53	H1/4U-SS5020	VEEJET NOZZLE, 303SS	16.33
H1/2U-8070	VEEJET NOZZLE,BRASS	40.53	H1/4U-SS6510	VEEJET NOZZLE, SS	16.33
H1/2U-9580	VEEJET NOZZLE,BRASS	40.53	H1/4U-SS6515	VEEJET NOZZLE, 303SS	16.33
H1/2U-SS80200	VEEJET NOZZLE,STL	119.37	H1/4U-SS6520	VEEJET NOZZLE, 303SS	16.33
H1/2U-SS9580	VEEJET NZ STL	119.37	H1/4U-SS8010	VEEJET NOZZLE, 303SS	16.33
H1/4U-0020	VEEJET NOZZLE, BRASS	11.98	H1/4U-SS8015	VEEJET NOZZLE, 303SS	16.33
H1/4U-0030	VEEJET NOZZLE, BRASS	11.98	H1/4U-SS8020	VEEJET NOZZLE, 303SS	16.33
H1/4U-0040	VEEJET NOZZLE, BRASS	11.98	H1/4U-SS8030	VEEJET NOZZLE, 303SS	16.33
H1/4U-0050	VEEJET NOZZLE, BRASS	11.98	H1/4U-SS8040	VEEJET NOZZLE, 303SS	16.33
H1/4U-0060	VEEJET NOZZLE, BRASS	11.98	H1/4U-SS8050	VEEJET NOZZLE, 303SS	16.33
H1/4U-0080	VEEJET NOZZLE, BRASS	11.98	H1/4U-SS8060	VEEJET NOZZLE, 303SS	16.33
H1/4U-0508HE	VEEJET NOZZLE, BRASS	8.40	H1/4U-SS8070	VEEJET NOZZLE, 303SS	16.33
H1/4U-0512HE	VEEJET NOZZLE, BRASS	8.40	H1/4U-SS9510	VEEJET NOZZLE, 303SS	16.33
H1/4U-0520HE	VEEJET NOZZLE,BRASS	8.40	H1/4U-SS9515	VEEJET NOZZLE, 303SS	16.33
H1/4U-0530HE	VEEJET NOZZLE,BRASS	8.40	H1/4U-SS9520	VEEJET NOZZLE, 303SS	16.33
H1/4U-0540E	VEEJET NOZZLE, BRASS, NPT	8.40	H1/4VV-1100033	VEEJET NOZZLE,BRASS	7.18
H1/4U-0540HE	VEEJET NOZZLE, BRASS	8.40	H1/4VV-11001	VEEJET NOZZLE,BRASS	7.18
H1/4U-1510	VEEJET NOZZLE, BRASS	8.01	H1/4VV-110015	VEEJET NOZZLE,BRASS	7.18
H1/4U-1515	VEEJET NOZZLE, BRASS	8.01	H1/4VV-11002	VEEJET NOZZLE,BRASS	7.18
H1/4U-1520	VEEJET NOZZLE, BRASS	8.01	H1/4VV-11003	VEEJET NOZZLE,BRASS	7.18
H1/4U-2510	VEEJET NOZZLE, BRASS	8.01	H1/4VV-11004	VEEJET NOZZLE,BRASS	7.18
H1/4U-2515	VEEJET NOZZLE, BRASS	8.01	H1/4VV-11005	VEEJET NOZZLE,BRASS	7.18
H1/4U-2520	VEEJET NOZZLE, BRASS, NPT	8.01	H1/4VV-11006	VEEJET NOZZLE,BRASS	7.18
H1/4U-4010	VEEJET NOZZLE, BRASS	8.01	H1/4VV-11008	VEEJET NOZZLE,BRASS	7.18
H1/4U-4015	VEEJET NOZZLE, BRASS	8.01	H1/4VV-11010	VEEJET NOZZLE,BRASS	7.18
H1/4U-4020	VEEJET NOZZLE, BRASS	8.01	H1/4VV-11015	VEEJET NOZZLE,BRASS	7.18
H1/4U-4030	VEEJET NOZZLE, BRASS	8.01	H1/4VV-1506	VEEJET NOZZLE,BRASS	7.18
H1/4U-5060	VEEJET NOZZLE, BRASS	8.01	H1/4VV-1508	VEEJET NOZZLE,BRASS	7.18
H1/4U-6540	VEEJET NOZZLE, BRASS, NPT	5.76	H1/4VV-4004	VEEJET NOZZLE,BRASS	7.18
H1/4U-6550	VEEJET NOZZLE, BRASS	5.76	H1/4VV-8001	VEEJET NOZZLE,BRASS	7.18
H1/4U-8015	VEEJET NOZZLE, BRASS	8.01	H1/4VV-80015	VEEJET NOZZLE,BRASS	7.18
H1/4U-9510	VEEJET NOZZLE, BRASS	8.01	H1/4VV-8002	VEEJET NOZZLE,BRASS	7.18
H1/4U-9520	VEEJET NOZZLE, BRASS	8.01	H1/4VV-8003	VEEJET NOZZLE,BRASS	7.18
H1/4U-SS00015	VEEJET NOZZLE, SS, NPT	21.43	H1/4VV-8004	VEEJET NOZZLE,BRASS	7.18
H1/4U-SS0002	VEEJET NOZZLE, 303SS	21.43	H1/4VV-8005	VEEJET NOZZLE,BRASS	7.18
H1/4U-SS0003	VEEJET NOZZLE, 303SS	21.43	H1/4VV-8006	VEEJET NOZZLE,BRASS	7.18
H1/4U-SS0004	VEEJET NOZZLE, 303SS	21.43	H1/4VV-8008	VEEJET NOZZLE,BRASS	7.18



# COMPREHENSIVE LIST

PART NO.	DESCRIPTION	U.S.DOLLARS	PART NO.	DESCRIPTION	U.S.DOLLARS
H1/4VV-9502	VEEJET NOZZLE,BRASS	7.18	H1/8U-SS4030	VEEJET NOZZLE, 303SS	14.73
H1/4VV-9503	VEEJET NOZZLE,BRASS	7.18	H1/8U-SS4050	VEEJET NOZZLE, SS, NPT	14.73
H1/4VV-9504	VEEJET NOZZLE,BRASS	7.18	H1/8U-SS5015	VEEJET NOZZLE, 303SS	14.73
H1/4VV-9505	VEEJET NOZZLE,BRASS	7.18	H1/8U-SS6510	VEEJET NOZZLE, SS	14.73
H1/4VV-9506	VEEJET NOZZLE,BRASS	7.18	H1/8U-SS6515	VEEJET NOZZLE, 303SS	14.73
H1/4VV-9508	VEEJET NOZZLE,BRASS	7.18	H1/8U-SS6520	VEEJET NOZZLE, 303SS	14.73
H1/4VV-SS11001	VEEJET NOZ,ST.STL.	16.33	H1/8U-SS8010	VEEJET NOZZLE, 303SS	14.73
H1/4VV-SS110015	VEEJET NOZ,ST.STL.	16.33	H1/8U-SS8015	VEEJET NOZZLE, 303SS	14.73
H1/4VV-SS11002	VEEJET NOZ,ST.STL.	16.33	H1/8U-SS8020	VEEJET NOZZLE, 303SS	14.73
H1/4VV-SS11003	VEEJET NOZ,ST.STL.	16.33	H1/8VV-11001	VEEJET NOZZLE,BRASS	6.76
H1/4VV-SS11004	VEEJET NOZ,ST.STL.	16.33	H1/8VV-110015	VEEJET NOZZLE,BRASS	6.76
H1/4VV-SS11005	VEEJET NOZ,ST.STL.	16.33	H1/8VV-11002	VEEJET NOZZLE,BRASS	6.76
H1/4VV-SS11006	VEEJET NOZ,ST.STL.	16.33	H1/8VV-11003	VEEJET NOZZLE,BRASS	6.76
H1/4VV-SS11008	VEEJET NOZ,ST.STL.	16.33	H1/8VV-11004	VEEJET NOZZLE,BRASS	6.76
H1/4VV-SS11010	VEEJET NOZ,ST.STL.	16.33	H1/8VV-11005	VEEJET NOZZLE,BRASS	6.76
H1/4VV-SS11015	VEEJET NOZ,ST.STL.	16.33	H1/8VV-11006	VEEJET NOZZLE,BRASS	6.76
H1/4VV-SS1501	VEEJET NOZ,ST.STL.	16.33	H1/8VV-11008	VEEJET NOZZLE,BRASS	6.76
H1/4VV-SS2503	VEEJET NOZ,ST.STL.	16.33	H1/8VV-11010	VEEJET NOZZLE,BRASS	6.76
H1/4VV-SS2505	VEEJET NOZ,ST.STL.	16.33	H1/8VV-11015	VEEJET NOZZLE,BRASS	6.76
H1/4VV-SS2506	VEEJET NOZ,ST.STL.	16.33	H1/8VV-8001	VEEJET NOZZLE,BRASS	7.17
H1/4VV-SS2508	VEEJET NOZ,ST.STL.	16.33	H1/8VV-SS11001	VEEJET NOZZLE,ST.STL	14.73
H1/4VV-SS4001	VEEJET NOZ,ST.STL.	16.33	H1/8VV-SS110015	VEEJET NOZZLE,ST.STL	14.73
H1/4VV-SS40015	VEEJET NOZ,ST.STL.	16.33	H1/8VV-SS11002	VEEJET NOZZLE,ST.STL	14.73
H1/4VV-SS4002	VEEJET NOZ,ST.STL.	16.33	H1/8VV-SS11003	VEEJET NOZZLE,ST.STL	14.73
H1/4VV-SS4004	VEEJET NOZ,ST.STL.	16.33	H1/8VV-SS11004	VEEJET NOZZLE,ST.STL	14.73
H1/4VV-SS40045	VEEJET NOZ,ST.STL.	16.33	H1/8VV-SS11005	VEEJET NOZZLE,ST.STL	14.73
H1/4VV-SS4005	VEEJET NOZ,ST.STL.	16.33	H1/8VV-SS11006	VEEJET NOZZLE,ST.STL	14.73
H1/4VV-SS40055	VEEJET NOZ,ST.STL.	16.33	H1/8VV-SS11008	VEEJET NOZZLE,ST.STL	14.73
H1/4VV-SS4006	VEEJET NOZ,ST.STL.	16.33	H1/8VV-SS11010	VEEJET NOZZLE,ST.STL	14.73
H1/4VV-SS4007	VEEJET NOZ,ST.STL.	16.33	H1/8VV-SS11015	VEEJET NOZZLE,ST.STL	14.73
H1/4VV-SS4008	VEEJET NOZ,ST.STL.	16.33	H1/8VV-SS6502	VEEJET NOZZLE,ST.STL	14.73
H1/4VV-SS5001	VEEJET NOZ,ST.STL.	16.33	H1/8VV-SS6503	VEEJET NOZZLE,ST.STL	14.73
H1/4VV-SS5002	VEEJET NOZ,ST.STL.	16.33	H1/8VV-SS6504	VEEJET NOZZLE,ST.STL	14.73
H1/4VV-SS5004	VEEJET NOZ,ST.STL.	16.33	H1/8VV-SS6505	VEEJET NOZZLE,ST.STL	14.73
H1/4VV-SS5005	VEEJET NOZ,ST.STL.	16.33	H1/8VV-SS6506	VEEJET NOZZLE,ST.STL	14.73
H1/4VV-SS5006	VEEJET NOZZLE, SS	16.33	H1/8VV-SS6508	VEEJET NOZZLE,ST.STL	14.73
H1/4VV-SS5007	VEEJET NOZ,ST.STL.	16.33	H1/8VV-SS8001	VEEJET NOZZLE,ST.STL	14.73
H1/4VV-SS6502	VEEJET NOZ,ST.STL.	16.33	H1/8VV-SS8002	VEEJET NOZZLE,ST.STL	14.73
H1/4VV-SS6503	VEEJET NOZ,ST.STL.	16.33	H1/8VV-SS8003	VEEJET NOZZLE,ST.STL	14.73
H1/4VV-SS6504	VEEJET NOZ,ST.STL.	16.33	H1/8VV-SS8004	VEEJET NOZZLE,ST.STL	14.73
H1/4VV-SS6505	VEEJET NOZ,ST.STL.	16.33	H1/8VV-SS8005	VEEJET NOZZLE,ST.STL	14.73
H1/4VV-SS6506	VEEJET NOZ,ST.STL.	16.33	H1/8VV-SS8006	VEEJET NOZZLE,ST.STL	14.73
H1/4VV-SS6508	VEEJET NOZ,ST.STL.	16.33	H1/8VV-SS8007	VEEJET NOZZLE,ST.STL	14.73
H1/4VV-SS8001	VEEJET NOZ,ST.STL.	16.33	H1/8VV-SS8008	VEEJET NOZZLE,ST.STL	14.73
H1/4VV-SS80015	VEEJET NOZ,ST.STL.	16.33	H1/8VV-SS9501	VEEJET NOZZLE,ST.STL	14.73
H1/4VV-SS8002	VEEJET NOZ,ST.STL.	16.33	H1/8VV-SS9502	VEEJET NOZZLE,ST.STL	14.73
H1/4VV-SS8003	VEEJET NOZ,ST.STL.	16.33	H1/8VV-SS9503	VEEJET NOZZLE,ST.STL	14.73
H1/4VV-SS8004	VEEJET NOZ,ST.STL.	16.33	H1/8VV-SS9504	VEEJET NOZZLE,ST.STL	14.73
H1/4VV-SS8005	VEEJET NOZ,ST.STL.	16.33	H1/8VV-SS9505	VEEJET NOZZLE,ST.STL	14.73
H1/4VV-SS8006	VEEJET NOZ,ST.STL.	16.33	H1/8VV-SS9506	VEEJET NOZZLE,ST.STL	14.73
H1/4VV-SS8007	VEEJET NOZ,ST.STL.	16.33	H1/8VV-SS9507	VEEJET NOZZLE,ST.STL	14.73
H1/4VV-SS8008	VEEJET NOZ,ST.STL.	16.33	H1/8VV-SS9508	VEEJET NOZZLE,ST.STL	14.73
H1/4VV-SS9505	VEEJET NOZ,ST.STL.	16.33	H3/4U-00350	VEEJET NOZZLE,BRASS	71.28
H1/4VV-SS9506	VEEJET NOZ,ST.STL.	16.33	H3/4U-50400	VEEJET NOZZLE,BRASS	71.28
H1/4VVL-11004	VEEJET NOZ,BR,W/STR.	12.30	H3/4U-65400	VEEJET NOZZLE,BRASS	71.28
H1/4VVL-11008	VEEJET NOZ,BR,W/STR.	12.30	H3/4U-80400	VEEJET NOZZLE,BRASS	71.28
H1/4VVL-9502	VEEJET NOZ,BR,W/STR.	12.30	H3/8U-50100	VEEJET NOZZLE,BRASS	30.66
H1/4VVL-9506	VEEJET NOZ,BR,W/STR.	12.30	H3/8U-80100	VEEJET NOZZLE,BRASS	30.66
H1/4VVL-SS8002	VEEJET NOZ,SS,W/STR.	25.62	H3/8U-80150	VEEJET NOZZLE,BRASS	30.66
H1/8U-0007	VEEJET NOZZLE, BRASS, NPT	11.38	H3/8U-SS00100	VEEJET NOZZLE,ST.STL	89.04
H1/8U-0008	VEEJET NOZZLE, BRASS	11.38	H3/8U-SS00120	VEEJET NOZZLE,ST.STL	89.04
H1/8U-0010	VEEJET NOZZLE, BRASS	11.38	H3/8U-SS0060	VEEJET NOZZLE,ST.STL	89.04
H1/8U-SS4015	VEEJET NOZZLE, 303SS	14.73	HAGQJ312-750-1-VI	QJ BODY W/CAPS VITON	3.55
H1/8U-SS4020	VEEJET NOZZLE, 303SS	14.73	LI322-W	WATER PAPER BROCHURE	17.31

PART NO.	DESCRIPTION	U.S.DOLLARS	PART NO.	DESCRIPTION	U.S.DOLLARS
OC-01	TEEJET OFFCTR TIP,BR	16.67	PK-114441A-7-CELR	QUICK TEEJET CAPS AND GASKETS, 4-PK	11.74
OC-02	TEEJET OFFCTR TIP,BR	16.67	PK-114441A-8-CELR	QUICK TEEJET CAPS AND GASKETS, 4-PK	11.74
OC-03	TEEJET OFFCTR TIP,BR	16.67	PK-114441A-9-CELR	QUICK TEEJET CAPS AND GASKETS, 4-PK	11.74
OC-04	TEEJET OFFCTR TIP,BR	16.67	PK-114443A-1-CELR	QUICK TEEJET CAPS AND GASKETS, 4-PK	16.24
OC-06	TEEJET OFFCTR TIP,BR	16.67	PK-114443A-1-CELR-ZA	QUICK TEEJET CAPS AND GASKETS, 4-PK	16.24
OC-08	TEEJET OFFCTR TIP,BR	16.67	PK-114445A-1-CELR	QUICK TEEJET CAPS AND GASKETS, 4-PK	16.24
OC-10	TEEJET OFFCTR TIP,BR	69.39	PK-114445A-10-CELR	QUICK TEEJET CAPS AND GASKETS, 4-PK	16.24
OC-12	TEEJET OFFCTR TIP,BR	16.67	PK-114445A-2-CELR	QUICK TEEJET CAPS AND GASKETS, 4-PK	16.24
OC-125	TEEJET OFFCTR TIP,BR	69.39	PK-114445A-3-CELR	QUICK TEEJET CAPS AND GASKETS, 4-PK	16.24
OC-150	TEEJET OFFCTR TIP,BR	69.39	PK-114445A-4-CELR	QUICK TEEJET CAPS AND GASKETS, 4-PK	16.24
OC-16	TEEJET OFFCTR TIP,BR	16.67	PK-114445A-5-CELR	QUICK TEEJET CAPS AND GASKETS, 4-PK	16.24
OC-20	TEEJET OFFCTR TIP,BR	69.39	PK-114445A-6-CELR	QUICK TEEJET CAPS AND GASKETS, 4-PK	16.24
OC-250	TEEJET OFFCTR TIP,BR	69.39	PK-114445A-7-CELR	QUICK TEEJET CAPS AND GASKETS, 4-PK	16.24
OC-30	TEEJET OFFCTR TIP,BR	69.39	PK-114445A-8-CELR	QUICK TEEJET CAPS AND GASKETS, 4-PK	16.24
OC-300	TEEJET OFFCTR TIP,BR	69.39	PK-114445A-9-CELR	QUICK TEEJET CAPS AND GASKETS, 4-PK	16.24
OC-40	TEEJET OFFCTR TIP,BR	69.39	PK-114447A-1-CELR	QUICK TEEJET CAPS AND GASKETS, 4-PK	22.12
OC-60	TEEJET OFFCTR TIP,BR	69.39	PK-18635-111-406-NYB-2	SINGLE HOSE SHANK,NY	17.45
OC-80	TEEJET OFFCTR TIP,BR	69.39	PK-18636-112-406-NYB-2	DBLE HOSE SHANK, NYB	17.45
OC-SS01	TEEJET OFFCTR.TIP,SS	24.62	PK-18637-113-406-NYB-2	QUICK TEEJET 3/8"	20.17
OC-SS015	TEEJET OFFCTR TIP,SS	24.62	PK-18638-111-540-NYB-2	SINGLE HOSE SHANK	17.45
OC-SS02	TEEJET OFFCTR TIP,SS	24.62	PK-18639-112-540-NYB-2	DOUBLE HOSE SHANK	17.45
OC-SS03	TEEJET OFFCTR TIP,SS	24.62	PK-18640-113-540-NYB-2	QUICK TEEJET 1/2"	20.17
OC-SS04	TEEJET OFFCTR TIP,SS	24.62	PK-18719-111-785-NYB-2	SINGLE HOSE SHANK,NY	17.45
OC-SS06	TEEJET OFFCTR TIP,SS	24.62	PK-18720-112-785-NYB-2	DOUBLE HOSE SHANK,NY	17.45
OC-SS08	TEEJET OFFCTR TIP,SS	24.62	PK-19349-211-406-NYB-2	HOSE SHANK ASB	35.70
OC-SS10	TEEJET OFFCTR TIP,SS	134.94	PK-19349-211-540-NYB-2	HOSE SHANK ASB	35.70
OC-SS12	TEEJET OFFCTR TIP,SS	24.62	PK-19350-212-406-NYB-2	HOSE SHANK ASB	35.70
OC-SS150	TEEJET OFFCTR TIP,SS	134.94	PK-19350-212-540-NYB-2	HOSE SHANK ASB	35.70
OC-SS16	TEEJET OFFCTR TIP,SS	24.62	PK-19351-213-406-NYB-2	HOSE SHANK ASB	35.70
OC-SS20	TEEJET OFFCTR TIP,SS	134.94	PK-19351-213-540-NYB-2	HOSE SHANK ASB	35.70
OC-SS30	TEEJET OFFCTR.TIP SS	134.94	PK-22251-311-500-NYB-2	HOSE SHANK ASB	30.47
OC-SS300	TEEJET OFFCTR TIP,SS	134.94	PK-22251-311-750-NYB-2	HOSE SHANK ASB	30.47
OC-SS40	TEEJET OFFCTR TIP,SS	134.94	PK-22252-312-500-NYB-2	HOSE SHANK ASB	30.47
OC-SS60	TEEJET OFFCTR.TIP SS	134.94	PK-22252-312-750-NYB-2	HOSE SHANK ASB	30.47
OC-SS80	TEEJET OFFCTR TIP,SS	134.94	PK-25600-2-NYR	CAP & GASKET	16.24
P1/8K-3	FLOODJET NOZ,BSPP,BR	7.92	PK-25600-6-NYR	CAP & GASKET	16.24
P98450-1/4M	DBLE ROLLOVER VALVE W/CHK BSPP	61.39	PK-38720-PPB-X18	ADJ.CONEJET TIP,BR.	11.65
P98450-2-1/4M	SPEC DBLE ROLLOVER VALVE W/CHK	66.18	PK-4193B-5-100SS	TEEJET CHECK VALVE	34.14
P98450-3-3/8M	SPEC DBLE ROLLOVER VALVE W/CHK	65.78	PK-4193B-5-50SS	TEEJET CHECK VALVE	34.14
P98450-3/8M	DBLE ROLLOVER VALVE W/CHK BSPP	61.39	PK-4193B-PP-5-100SS	TEEJET CHECK VALVE	29.15
P98451-1/4M	BSPP SINGLE ROLLOVER VALVE W/CHK CP98455-8	56.98	PK-4193B-PP-5-24SS	TEEJET CHECK VALVE	29.15
P98453-1/4M	SINGLE ROLLOVER VALVE, BSPP	43.84	PK-4193B-PP-5-50SS	TEEJET CHECK VALVE	29.15
P98453-3/8M	SINGLE ROLLOVER VALVE, BSPP	43.84	PK-4514-32	SLOTTED STR.	14.03
PK-1/4XP10L-VP	XP BOOMJET (LEFT)	79.82	PK-4514-NY-10	SLOTTED STR.	13.55
PK-1/4XP10R-VP	XP BOOMJET (RIGHT)	79.82	PK-4514-NY-20	SLOTTED STR.	13.55
PK-114441A-1-CELR	QUICK TEEJET CAPS AND GASKETS, 4-PK	11.74	PK-4514-NY-32	SLOTTED STR.	13.55
PK-114441A-1-CELR-ZA	QUICK TEEJET CAPS AND GASKETS, 4-PK	11.74	PK-4676-1/4	OUTLET ADAPT.	22.31
PK-114441A-10-CELR	QUICK TEEJET CAPS AND GASKETS, 4-PK	11.74	PK-4676-NYB-1/4	OUTLET ADAPT.	19.58
PK-114441A-2-CELR	QUICK TEEJET CAPS AND GASKETS, 4-PK	11.74	PK-5053-100-SS	TEEJET STRAINER	22.59
PK-114441A-3-CELR	QUICK TEEJET CAPS AND GASKETS, 4-PK	11.74	PK-5053-100-SS-10	TEEJET STRAINER	44.63
PK-114441A-4-CELR	QUICK TEEJET CAPS AND GASKETS, 4-PK	11.74			
PK-114441A-5-CELR	QUICK TEEJET CAPS AND GASKETS, 4-PK	11.74			
PK-114441A-6-CELR	QUICK TEEJET	11.74			

PART NO.	DESCRIPTION	U.S.DOLLARS	PART NO.	DESCRIPTION	U.S.DOLLARS
PK-5053-50-SS	TEEJET STRAINER	22.59	PK-AB6815-AL-300-KIT	REPAIR KIT	22.71
PK-5500-PPB-X18	ADJ.CONEJET TIP,BR.	15.80	PK-AB6B-KIT	REPAIR KIT	32.18
PK-5500-X8	ADJ. CONEJET TIP, BR	31.66	PK-AB8460-50-KIT	REPAIR KIT 8460-*-50	34.41
PK-8079-PP-100	TEEJET STRAINER	12.81	PK-AB8460-KIT	REPAIR KIT	34.41
PK-8079-PP-100-10	TEEJET STRAINER QTY 10	25.11	PK-AI110015-VS	TEEJET TIP	84.50
PK-8079-PP-100-ZA	TEEJET STRAINER QTY 10	25.11	PK-AI11002-VS	TEEJET TIP	84.50
PK-8079-PP-24	TEEJET STRAINER	12.81	PK-AI110025-VS	TEEJET TIP	84.50
PK-8079-PP-50	TEEJET STRAINER	12.81	PK-AI11003-VS	TEEJET TIP	84.50
PK-8079-PP-50-10	TEEJET STRAINER QTY 10	25.11	PK-AI11004-VS	TEEJET TIP	84.50
PK-8079-PP-50-ZA	TEEJET STRAINER QTY 10	25.11	PK-AI11005-VS	TEEJET TIP	84.50
PK-8120-NYB-406TD	HOSE SHANK ADAPTER	17.27	PK-AI11006-VS	TEEJET TIP	84.50
PK-8120-NYB-540TD	HOSE SHK.ADP.	17.27	PK-AI11008-VS	TEEJET TIP	84.50
PK-8121-NYB-406TD	HOSE SHANK ADAPTER	17.27	PK-AIC110015-VS	TEEJET TIP/CAP AI	94.73
PK-8121-NYB-540TD	HOSE SHANK ADAPTER	17.27	PK-AIC11002-VS	TEEJET TIP/CAP AI	94.73
PK-8400-406-NYB	HOSE CONNECTION 3/8"	11.30	PK-AIC110025-VS	TEEJET TIP/CAP AI	94.73
PK-8400-500-NYB	HOSE CONNECTION 1/2"	11.30	PK-AIC11003-VS	TEEJET TIP/CAP AI	94.73
PK-8600-1/4T-NYB	SWV.BDY ASB	21.42	PK-AIC11004-VP	TEEJET TIP/CAP AI	43.27
PK-8600-2-1/4T-NYB	SWV.BDY ASB.	25.66	PK-AIC11004-VS	TEEJET TIP/CAP AI	94.73
PK-8600-2-1/4T-NYB-2	SWILVEL BODY ASB	40.90	PK-AIC11005-VS	TEEJET TIP/CAP AI	94.73
PK-AA1111-1	VARI SPACE CLAMP	21.77	PK-AIC11006-VS	TEEJET TIP/CAP AI	94.73
PK-AA1111-1/2	VARI-SPACE CLAMP	21.77	PK-AIC11008-VS	TEEJET TIP/CAP AI	94.73
PK-AA1111-3/4	VARI-SPC.CLP.	21.77	PK-AIC11010-VS	TEEJET TIP/CAP AI	94.73
PK-AA1111SQ-1	VARI-SPC.CLP.	23.72	PK-AITTJ60-110025VP	AI/TURBO TWINJET	54.74
PK-AA1111SQ-1-1/2	VARI-SPACE CLAMP	31.23	PK-AITTJ60-11002VP	AI/TURBO TWINJET	54.74
PK-AA1111SQ-1-1/4	VARI-SPC CLP	31.23	PK-AITTJ60-11002VP-ZA	AI/TURBO TWINJET - QTY 10	129.32
PK-AB12-AL-KIT	REPAIR KIT	44.35	PK-AITTJ60-11003VP	AI/TURBO TWINJET	54.74
PK-AB12-KIT	REPAIR KIT	30.94	PK-AITTJ60-11003VP-ZA	AI/TURBO TWINJET - QTY 10	129.32
PK-AB12A-KIT	REPAIR KIT	30.94	PK-AITTJ60-11004VP	AI/TURBO TWINJET	54.74
PK-AB143-AL-KIT	REPAIR KIT	44.03	PK-AITTJ60-11004VP-ZA	AI/TURBO TWINJET - QTY 10	129.32
PK-AB143-KIT	REPAIR KIT	44.03	PK-AITTJ60-11005VP	AI/TURBO TWINJET	54.74
PK-AB144-1-3-KIT	REPAIR KIT	48.03	PK-AITTJ60-11005VP-ZA	AI/TURBO TWINJET - QTY 10	129.32
PK-AB144-1-KIT	REPAIR KIT	41.86	PK-AITTJ60-11006VP	AI/TURBO TWINJET	54.74
PK-AB144-1-VI-KIT	REPAIR KIT,VITON	62.59	PK-AITTJ60-11006VP-ZA	AI/TURBO TWINJET - QTY 10	129.32
PK-AB144A-1-3-KIT	REPAIR KIT	48.03	PK-AITTJ60-11008VP-ZA	AI/TURBO TWINJET - QTY 10	129.32
PK-AB144A-1-3-VI-KIT	REPAIR KIT,VITON	68.82	PK-AIXR110015VP	AIR INDUCTION XR TIP	49.80
PK-AB144A-1-KIT	REPAIR KIT	41.86	PK-AIXR110025VP	AIR INDUCTION XR TIP	49.80
PK-AB144A-1-VI-KIT	REPAIR KIT,VITON	62.59	PK-AIXR110025VP-ZA	AIR INDUCTION XR TIP - QTY 10	115.56
PK-AB144P-1-KIT	REPAIR KIT	62.59	PK-AIXR11002VP	AIR INDUCTION XR TIP	49.80
PK-AB145H-KIT	REPAIR KIT	75.35	PK-AIXR11002VP-ZA	AIR INDUCTION XR TIP - QTY 10	115.56
PK-AB17-KIT	REPAIR KIT	54.02	PK-AIXR11003VP	AIR INDUCTION XR TIP	49.80
PK-AB18-AL-KIT	REPAIR KIT	34.01	PK-AIXR11003VP-ZA	AIR INDUCTION XR TIP - QTY 10	115.56
PK-AB18-KIT	REPAIR KIT	30.94	PK-AIXR11004VP	AIR INDUCTION XR TIP	49.80
PK-AB2-AL-KIT	REPAIR KIT	26.64	PK-AIXR11004VP-ZA	AIR INDUCTION XR TIP - QTY 10	115.56
PK-AB2-KIT	REPAIR KIT	30.29	PK-AIXR11005VP	AIR INDUCTION XR TIP	49.80
PK-AB22650-PP-KIT	REPAIR KIT	14.41	PK-AIXR11005VP-ZA	AIR INDUCTION XR TIP - QTY 10	115.56
PK-AB22670-PP-KIT	REPAIR KIT	19.31	PK-AIXR11006VP	AIR INDUCTION XR TIP	49.80
PK-AB23120-60-VI-KIT	REPAIR KIT	25.63	PK-AIXR11006VP-ZA	AIR INDUCTION XR TIP - QTY 10	115.56
PK-AB23120-KIT	REPAIR KIT	25.63	PK-BACKPACK-MU	TIP/STRAINER COMBO	31.25
PK-AB23120A-KIT	REPAIR KIT	30.07	PK-CP12094-NYB	TEEJET BODY	17.41
PK-AB23H-KIT	REPAIR KIT	35.45	PK-CP1321	TEEJET BODY	21.06
PK-AB23L-KIT	REPAIR KIT	31.34	PK-CP1322	TEEJET BODY	21.58
PK-AB25660-KIT	REPAIR KIT	28.14	PK-CP1325	TEEJET CAP	13.97
PK-AB2A-AL-KIT	REPAIR KIT	26.64	PK-CP18032A-NYB	NYLON TEEJET CAP (4 PK)	13.38
PK-AB2A-KIT	REPAIR KIT	24.32	PK-CP18999-EPR	SEAL EPDM RUBBER (12 PK)	25.69
PK-AB30-KIT	REPAIR KIT	28.91	PK-CP19438-EPR	SEAT GASKET	15.06
PK-AB30L-PP-KIT	REPAIR KIT	23.95	PK-CP19438-EPR-10	SEAT GASKET, QTY 10	14.63
PK-AB31-KIT	REPAIR KIT	26.84	PK-CP19438-EPR-ZA	SEAT GASKET, QTY 10	14.63
PK-AB36-KIT	REPAIR KIT	31.00	PK-CP19438-VI	SEAT GASKET	42.15
PK-AB39920-144A-VI-KIT	REPAIR KIT,VITON	62.59	PK-CP21953-EPR	CHEM.SAV.DIA.	9.13
PK-AB43-AL-KIT	REPAIR KIT	58.38	PK-CP21953-EPR-12	CHEM/SAV DIAPHRAM	11.00
PK-AB43-KIT	REPAIR KIT	58.38	PK-CP21953-EPR-24	CHEM/SAV DIAPHRAM	20.35
PK-AB4688-KIT	REPAIR KIT	22.27	PK-CP2930-100-SS	TEEJET SCREEN	22.35
PK-AB60-KIT	REPAIR KIT	54.38	PK-CP3942	PLUG TIP	13.19
PK-AB6815-300-KIT	REPAIR KIT	24.09	PK-CP3942-SS	BLK PLUG TIP,SS,1/4T (4 PK)	9.26

PART NO.	DESCRIPTION	U.S.DOLLARS	PART NO.	DESCRIPTION	U.S.DOLLARS
PK-CP8027-NYB	TEEJET CAP	11.34	PK-PROMO-NA16-03	TIP SAMPLE PACK	62.89
PK-CP8028-NYB	TEEJET BODY	15.80	PK-PROMO-NA16-04	TIP SAMPLE PACK	62.89
PK-D1	ORIFICE DISC,HARD.SS (12 PK)	28.91	PK-PROMO-NA16-05	TIP SAMPLE PACK	62.89
PK-D10	ORIFICE DISC, HSS	28.91	PK-QJ1/4T-NYB	QJ-1/4T QUICKJT,BODY	25.16
PK-D2	ORIFICE DISC, HSS	28.91	PK-QJ1/4TT-NYB	QJ BODY	25.16
PK-D3	ORIFICE DISC, HSS	28.91	PK-QJ111-1	VARI-SPC.CLP	16.37
PK-D4	ORIFICE DISC, HSS	28.91	PK-QJ111-3/4	VARI-SPC.CLP	16.37
PK-D5	ORIFICE DISC, HSS	28.91	PK-QJ111SQ-1	VARI-SPC CLP	16.37
PK-D6	ORIFICE DISC, HSS	28.91	PK-QJ111SQ-1-1/2	VARI-SPC CLP	16.37
PK-D7	ORIFICE DISC, HSS	28.91	PK-QJ111SQ-1-1/4	VARI-SPC CLP	16.37
PK-D8	ORIFICE DISC, HSS	28.91	PK-QJ111SQ-3/4	3/4" SQUARE CLAMP (2 PK)	16.37
PK-DC13-NY	TEEJET CORE, NYLON	25.08	PK-QJ17560A-1-NYB-2	SPLIT EYELET CV (2 PK)	14.40
PK-DC23-NY	TEEJET CORE, NYLON	25.08	PK-QJ17560A-3/4-NYB-2	SPLIT EYELET CV (2 PK)	14.40
PK-DC25	TEEJET CORE, BRASS	46.36	PK-QJ4676-1/4-NYR	ADAPTER	28.75
PK-DC25-NY	TEEJET CORE, NYLON	25.08	PK-QJ8360-NYB	CHEM SAVER	21.31
PK-DC35	TEEJET CORE.BRASS (12 PK)	46.36	PK-QJ8600-1/4-NYB-2	QJ SWIVEL BODY ASB (2 PK)	29.84
PK-DC45	TEEJET CORE.BRASS (12 PK)	46.36	PK-QJ8600-1/4T-NYB-2	SWIVEL BODY ASB	33.35
PK-DC45-NY	TEEJET CORE, NYLON	25.08	PK-QJ8600-2-1/4-NYB-2	QJ SWIVEL BODY ASB (2 PK)	34.35
PK-DC46-NY	TEEJET CORE, NYLON	25.08	PK-QJT-NYB	NOZ.BDY ADP.	37.35
PK-DC56-NY	TEEJET CORE, NYLON	25.08	PK-QJT8360-NYB	NOZ.BDY ADP.	25.04
PK-DG8002-VS	DG TEEJET TIP	62.89	PK-SJ3-06-VP	TJ STRMJT / GRAY (4 PK)	59.45
PK-DG8003-VS	DG TEEJET TIP	62.89	PK-SJ3-08-VP	TJ STRMJT / WHITE (4 PK)	59.45
PK-DG8004-VS	DG TEEJET TIP	62.89	PK-SJ3-10-VP	TJ STRMJT / LT BLUE (4 PK)	59.45
PK-OC-02	TEEJET TIP (4 PK)	71.98	PK-SJ3-15-VP	TJ STRMJT / LT GREEN (4 PK)	59.45
PK-OC-03	TEEJET TIP (4 PK)	71.98	PK-TF-VP10	TURBO FLOODJT, POLYMR	24.05
PK-OC-04	TEEJET TIP (4 PK)	71.98	PK-TF-VP2	TURBO FLOODJT, POLYMR	24.05
PK-OC-06	TEEJET TIP (4 PK)	71.98	PK-TF-VP2.5	TURBO FLOODJT, POLYMR	24.05
PK-OC-08	TEEJET TIP (4 PK)	71.98	PK-TF-VP3	TURBO FLOODJT, POLYMR	24.05
PK-PROMO-EU-BLKGRS	TIP SAMPLE BLACKGRASS UK	34.01	PK-TF-VP4	TURBO FLOODJT, POLYMR	24.05
PK-PROMO-EU-ET	TIP SAMPLE ESTONIAN	63.92	PK-TF-VP5	TURBO FLOODJT, POLYMR	24.05
PK-PROMO-EU-IT	TIP SAMPLE ITALIAN	51.67	PK-TF-VP7.5	TURBO FLOODJT, POLYMR	24.05
PK-PROMO-EU-LT	TIP SAMPLE LITHUANIAN	58.56	PK-TF-VS2	TURBO FLOODJT, POLYMR	83.38
PK-PROMO-EU-OR-PL	TIP SAMPLE ORCHARD	80.94	PK-TF-VS2.5	TURBO FLOODJET TIP	83.38
PK-PROMO-EU-PL-2	TIP SAMPLE POLISH	37.03	PK-TF-VS3	TURBO FLOODJET TIP	83.38
PK-PROMO-EU-PL-3	TIP SAMPLE POLISH	72.56	PK-TF-VS4	TURBO FLOODJET TIP	83.38
PK-PROMO-EU-RU	TIP SAMPLE RUSSIAN	68.95	PK-TF-VS5	TURBO FLOODJET TIP	83.38
PK-PROMO-EU-RU-1	TIP SAMPLE RUSSIAN	51.97	PK-TF-VS7.5	TURBO FLOODJET TIP	83.38
PK-PROMO-EU-RU-2	TIP SAMPLE RUSSIAN	30.79	PK-TG-3	FULL CONE TIP	59.18
PK-PROMO-EU-RU-3	TIP SAMPLE RUSSIAN	63.20	PK-TG-5	FULL CONE TIP	59.18
PK-PROMO-EU12-CS	TIP SAMPLE CZECH	63.92	PK-TK-1.5	FLOODJET TIP	46.10
PK-PROMO-EU12-DA	TIP SAMPLE DANISH	63.92	PK-TK-2	FLOODJET TIP	46.10
PK-PROMO-EU12-DE	TIP SAMPLE GERMAN	63.92	PK-TK-2.5	FLOODJET TIP	46.10
PK-PROMO-EU12-EN	TIP SAMPLE ENGLISH	63.92	PK-TK-3	FLOODJET TIP	46.10
PK-PROMO-EU12-ES	TIP SAMPLE SPANISH	63.92	PK-TK-4	FLOODJET TIP	46.10
PK-PROMO-EU12-FI	TIP SAMPLE FINNISH	63.92	PK-TK-5	FLOODJET TIP	46.10
PK-PROMO-EU12-FI-1	TIP SAMPLE FINNISH	63.92	PK-TK-7.5	FLOODJET TIP	46.10
PK-PROMO-EU12-FR	TIP SAMPLE FRENCH	63.92	PK-TK-SS3	FLOODJET TIP	81.12
PK-PROMO-EU12-HU	TIP SAMPLE HUNGARIAN	63.92	PK-TK-SS4	FLOODJET TIP	81.12
PK-PROMO-EU12-IT	TIP SAMPLE ITALIAN	63.92	PK-TK-SS5	FLOODJET TIP	81.12
PK-PROMO-EU12-PL	TIP SAMPLE POLISH	63.92	PK-TK-VP1-ZA	VISIFLO FLOODJET QTY 5	14.52
PK-PROMO-EU12-RU	TIP SAMPLE RUSSIAN	63.92	PK-TK-VP1.5-ZA	VISIFLO FLOODJET QTY 5	14.52
PK-PROMO-EU13-DE	TIP SAMPLE GERMAN	63.92	PK-TK-VP2-ZA	VISIFLO FLOODJET QTY 5	14.52
PK-PROMO-NA-DIC	TIP SAMPLE DICAMBA	21.21	PK-TK-VP2.5-ZA	VISIFLO FLOODJET QTY 5	14.52
PK-PROMO-NA-TRF	TIP SAMPLE TURF	52.67	PK-TK-VS10	VISIFLO TIP	77.54
PK-PROMO-NA-TS-03	PK-PROMO-NA-TS-03 TANK STICKER TIP SAMPLE	135.02	PK-TK-VS2	VISIFLO TIP	77.54
PK-PROMO-NA-TS-04	PK-PROMO-NA-TS-04 TANK STICKER TIP SAMPLE	135.02	PK-TK-VS2.5	VISIFLO TIP	77.54
PK-PROMO-NA12	TIP SAMPLE PACK	60.26	PK-TK-VS3	VISIFLO TIP	77.54
PK-PROMO-NA12-AF	TIP SAMPLE AFRIKAANS	65.03	PK-TK-VS4	VISIFLO TIP	77.54
PK-PROMO-NA12-CA	TIP SAMPLE PACK	69.13	PK-TK-VS5	VISIFLO TIP	77.54
PK-PROMO-NA12-SE	TIP SAMPLE PACK	67.74	PK-TK-VS7.5	VISIFLO TIP	77.54
PK-PROMO-NA12-SE1	TIP SAMPLE PACK	67.74	PK-TKT-VP3	FLOODJET	21.28
PK-PROMO-NA12-TRF	TIP SAMPLE TURF	52.67	PK-TKT-VP5	FLOODJET	21.31
			PK-TP110015	VISIFLO TIP (4 PK)	30.48
			PK-TP110015VP-ZA	TEEJET TIP POLYMER - QTY 10	20.38

PART NO.	DESCRIPTION	U.S.DOLLARS	PART NO.	DESCRIPTION	U.S.DOLLARS
PK-TP110015VS	VISIFLO TIP	43.25	PK-TT11008-VP	TURBO TEEJET	40.77
PK-TP11002-VS	VISIFLO TIP	43.25	PK-TT11008-VP-ZA	TURBO TEEJET QTY 10	105.34
PK-TP11002VP-ZA	TEEJET TIP POLYMER - QTY 10	20.38	PK-TT110015-VP	TT INDUCTION TIP	74.04
PK-TP11003VP-ZA	TEEJET TIP POLYMER - QTY 10	20.38	PK-TT11002-VP	TT INDUCTION TIP	74.04
PK-TP11004VP-ZA	TEEJET TIP POLYMER - QTY 10	20.38	PK-TT110025-VP	TT INDUCTION TIP	74.04
PK-TP11005VP-ZA	TEEJET TIP POLYMER - QTY 10	20.38	PK-TT11003-VP	TT INDUCTION TIP	74.04
PK-TP730077	TEEJET TIP	31.31	PK-TT11004-VP	TT INDUCTION TIP	74.04
PK-TP730116	TEEJET TIP	31.31	PK-TT11005-VP	TT INDUCTION TIP	74.04
PK-TP730154	TEEJET TIP	31.31	PK-TT11006-VP	TT INDUCTION TIP	74.04
PK-TP730231	TEEJET TIP	31.31	PK-TT11008-VP	TT INDUCTION TIP	86.47
PK-TP730308	TEEJET TIP	31.31	PK-TT11010-VP	TT INDUCTION TIP	86.47
PK-TP730385	TEEJET TIP	31.31	PK-TTJ60-110025VP	TURBO TWINJET	53.19
PK-TP730462	TEEJET TIP	31.31	PK-TTJ60-11002VP	TURBO TWINJET	53.19
PK-TP730616	TEEJET TIP	31.31	PK-TTJ60-11002VP-ZA	TURBO TWINJET QTY: 10	124.87
PK-TP8001	TEEJET TIP	30.48	PK-TTJ60-11003VP	TURBO TWINJET	53.19
PK-TP80015	TEEJET TIP	30.48	PK-TTJ60-11003VP-ZA	TURBO TWINJET QTY: 10	124.87
PK-TP80015E	TEEJET TIP	30.74	PK-TTJ60-11004VP	TURBO TWINJET	53.19
PK-TP80015EVS	VISIFLO TIP	42.42	PK-TTJ60-11004VP-ZA	TURBO TWINJET QTY: 10	124.87
PK-TP80015VP	TEEJET TIP	12.68	PK-TTJ60-11005VP	TURBO TWINJET	53.19
PK-TP80015VS	VISIFLO TIP	42.42	PK-TTJ60-11005VP-ZA	TURBO TWINJET QTY: 10	124.87
PK-TP8001E	TEEJET TIP	30.74	PK-TTJ60-11006VP	TURBO TWINJET	53.19
PK-TP8001VS	VISIFLO TIP	42.42	PK-TTJ60-11006VP-ZA	TURBO TWINJET QTY: 10	124.87
PK-TP8002	TEEJET TIP	30.48	PK-TTJ60-11008VP-ZA	TURBO TWINJET QTY: 10	124.87
PK-TP8002E	TEEJET TIP	30.74	PK-TX-1	CONEJET TIP	41.10
PK-TP8002EVS	VISIFLO TIP	42.42	PK-TX-10	CONEJET TIP	41.10
PK-TP8002VP	TEEJET TIP	12.68	PK-TX-12	CONEJET TIP	41.10
PK-TP8002VS	VISIFLO TIP	42.42	PK-TX-18	CONEJET TIP	41.10
PK-TP8003	TEEJET TIP	30.48	PK-TX-26	CONEJET TIP	41.10
PK-TP8003E	TEEJET TIP	30.74	PK-TX-3	CONEJET TIP	41.10
PK-TP8003EVS	VISIFLO TIP	42.42	PK-TX-4	CONEJET TIP	41.10
PK-TP8003VP	TEEJET TIP	12.68	PK-TX-6	CONEJET TIP	41.10
PK-TP8003VS	VISIFLO TIP	42.42	PK-TX-8	CONEJET TIP	41.10
PK-TP8004	TEEJET TIP	30.48	PK-XR110015VS	XR TEEJET	43.83
PK-TP8004E	TEEJET TIP	30.74	PK-XR110015VS-10-ZH	XR TEEJET 10-PK CHINESE	109.59
PK-TP8004EVS	VISIFLO TIP	42.42	PK-XR11001VS	XR TEEJET	43.83
PK-TP8004VP	TEEJET TIP	12.68	PK-XR11001VS-10-ZH	XR TEEJET 10-PK CHINESE	109.59
PK-TP8004VS	VISIFLO TIP	42.42	PK-XR11002-VP	POLYMER XR TEEJET	24.10
PK-TP8005	TEEJET TIP	30.48	PK-XR11002-VS	XR TEEJET	43.83
PK-TP8005E	TEEJET TIP	30.74	PK-XR11003-VP	POLYMER XR TEEJET	24.10
PK-TP8005EVS	VISIFLO TIP	42.42	PK-XR11003-VS	XR TEEJET	43.83
PK-TP8005VP	TEEJET TIP	12.68	PK-XR11004-VP	POLYMER XR TEEJET	24.10
PK-TP8005VS	VISIFLO TIP	42.42	PK-XR11004-VS	XR TEEJET	43.83
PK-TP8006	TEEJET TIP	30.48	PK-XR11005-VP	POLYMER XR TEEJET	24.10
PK-TP8006E	TEEJET TIP	30.74	PK-XR11005-VS	XR TEEJET	43.83
PK-TP8006VP	VISIFLO TIP	12.68	PK-XR11006-VS	XR TEEJET	43.83
PK-TP8006VS	VISIFLO TIP	42.42	PK-XR11008-VS	XR TEEJET	43.83
PK-TP8008	TEEJET TIP	30.48	PK-XR80015VS	XR TEEJET	43.83
PK-TP8008VP	VISIFLO TIP (4 PK)	12.68	PK-XR8001VS	XR TEEJET	43.83
PK-TP8008VS	VISIFLO TIP	42.42	PK-XR8002VS	XR TEEJET	43.83
PK-TP8010	TEEJET TIP	30.48	PK-XR8003VS	XR TEEJET	43.83
PK-TT11001-VP	TURBO TEEJET	40.77	PK-XR8004VS	XR TEEJET	43.83
PK-TT11001-VP-ZA	TURBO TEEJET QTY 10	105.34	PK-XR8005VS	XR TEEJET	43.83
PK-TT110015-VP	TURBO TEEJET	40.77	PK-XR8006VS	XR TEEJET	43.83
PK-TT11002-VP	TURBO TEEJET	40.77	PK-XR8008VS	XR TEEJET	43.83
PK-TT11002-VP-ZA	TURBO TEEJET QTY 10	105.34	PK-XRC110025-VS	TEEJET TIP/CAP XR	52.40
PK-TT110025-VP	TURBO TEEJET	40.77	PK-XRC11003-VS	TEEJET TIP/CAP XR	52.40
PK-TT11003-VP	TURBO TEEJET	40.77	PK-XRC11004-VS	TEEJET TIP/CAP XR	52.40
PK-TT11003-VP-ZA	TURBO TEEJET QTY 10	105.34	PK-XRC11005-VS	TEEJET TIP/CAP XR	52.40
PK-TT11004-VP	TURBO TEEJET	40.77	PTC-140-1/4	PTC QJ CAP 1/4" OD HOSE W/ CP4916-140	14.13
PK-TT11004-VP-ZA	TURBO TEEJET QTY 10	105.34	PTC-140-3/8	PTC QJ CAP 3/8" OD HOSE W/ CP4916-140	14.13
PK-TT11005-VP	TURBO TEEJET	40.77	PTC-140-5/16	PTC QJ CAP 5/16" OD HOSE W/ CP4916-140	14.13
PK-TT11005-VP-ZA	TURBO TEEJET QTY 10	105.34			
PK-TT11006-VP	TURBO TEEJET	40.77			
PK-TT11006-VP-ZA	TURBO TEEJET QTY 10	105.34			

PART NO.	DESCRIPTION	U.S.DOLLARS	PART NO.	DESCRIPTION	U.S.DOLLARS
PTC-VR-X0.5-1/4	VARIABLE RATE PTC/YELLOW X0.5	40.13	QC365-NYB-VI	365 5 OUTLET, QC,VI	26.84
PTC-VR-X0.5-1/4-10	X0.5 VARIABLE RATE PTC W/ 10 PSI DCV	57.62	QCK-SS100	TIP ASB.QUICK CONN.	76.55
PTC-VR-X0.5-1/4-2	X0.5 VARIABLE RATE PTC W/ 2 PSI DCV	57.62	QCK-SS120	TIP ASB.QUICK CONN.	76.55
PTC-VR-X0.5-1/4-5	X0.5 VARIABLE RATE PTC W/ 5 PSI DCV	57.62	QCK-SS150	TIP ASB.QUICK CONN.	120.99
PTC-VR-X0.5-3/8	VARIABLE RATE PTC/YELLOW X0.5	40.13	QCK-SS180	TIP ASB.QUICK CONN.	120.99
PTC-VR-X0.5-3/8-10	X0.5 VARIABLE RATE PTC W/ 10 PSI DCV	57.62	QCK-SS20	TIP ASB.QUICK CONN.	56.12
PTC-VR-X0.5-3/8-2	X0.5 VARIABLE RATE PTC W/ 2 PSI DCV	57.62	QCK-SS210	TIP ASB.QUICK CONN.	120.99
PTC-VR-X0.5-3/8-5	X0.5 VARIABLE RATE PTC W/ 5 PSI DCV	57.62	QCK-SS30	TIP ASB.QUICK CONN.	56.12
PTC-VR-X0.5-5/16	VARIABLE RATE PTC/YELLOW X0.5	40.13	QCK-SS40	TIP ASB.QUICK CONN.	56.12
PTC-VR-X0.5-5/16-10	X0.5 VARIABLE RATE PTC W/ 10 PSI DCV	57.62	QCK-SS50	TIP ASB.QUICK CONN.	61.36
PTC-VR-X0.5-5/16-2	X0.5 VARIABLE RATE PTC W/ 2 PSI DCV	57.62	QCK-SS60	TIP ASB.QUICK CONN.	61.36
PTC-VR-X0.5-5/16-5	X0.5 VARIABLE RATE PTC W/ 5 PSI DCV	57.62	QCK-SS80	TIP ASB.QUICK CONN.	61.36
PTC-VR-X1.0-1/4	VARIABLE RATE PTC/RED X1.0	40.13	QCT	CAM LOC ADAPTER	31.28
PTC-VR-X1.0-1/4-10	X1.0 VARIABLE RATE PTC W/ 10 PSI DCV	57.62	QCTF-VS100	TURBO FLOODJET NOZ.	71.23
PTC-VR-X1.0-1/4-2	X1.0 VARIABLE RATE PTC W/ 2 PSI DCV	57.62	QCTF-VS120	TURBO FLOODJET NOZ.	71.23
PTC-VR-X1.0-1/4-5	X1.0 VARIABLE RATE PTC W/ 5 PSI DCV	57.62	QCTF-VS15	TURBO FLOODJET NOZ.	52.19
PTC-VR-X1.0-3/8	VARIABLE RATE PTC/RED X1.0	40.13	QCTF-VS20	TURBO FLOODJET NOZ.	52.19
PTC-VR-X1.0-3/8-10	X1.0 VARIABLE RATE PTC W/ 10 PSI DCV	57.62	QCTF-VS30	TURBO FLOODJET NOZ.	52.19
PTC-VR-X1.0-3/8-2	X1.0 VARIABLE RATE PTC W/ 2 PSI DCV	57.62	QCTF-VS40	TURBO FLOODJET NOZ.	52.19
PTC-VR-X1.0-3/8-5	X1.0 VARIABLE RATE PTC W/ 5 PSI DCV	57.62	QCTF-VS50	TURBO FLOODJET NOZ.	52.19
PTC-VR-X1.0-5/16	VARIABLE RATE PTC/RED X1.0	40.13	QCTF-VS60	TURBO FLOODJET NOZ.	52.19
PTC-VR-X1.0-5/16-10	X1.0 VARIABLE RATE PTC W/ 10 PSI DCV	57.62	QCTF-VS80	TURBO FLOODJET NOZ.	52.19
PTC-VR-X1.0-5/16-2	X1.0 VARIABLE RATE PTC W/ 2 PSI DCV	57.62	QJ-VR-X0.5	VARIABLE RATE QJ LESS HOSE BARB/YELLOW X0.5	34.53
PTC-VR-X1.0-5/16-5	X1.0 VARIABLE RATE PTC W/ 5 PSI DCV	57.62	QJ-VR-X0.5-1/4-SS	VARIABLE RATE HOSE BARB/YELLOW X0.5	55.94
PTC-VR-X2.0-3/8	VARIABLE RATE PTC/LIGHT BLUE X2.0	40.13	QJ-VR-X0.5-3/8-NYB	VARIABLE RATE HOSE BARB/YELLOW X0.5	41.43
PTC-VR-X2.0-3/8-10	X2.0 VARIABLE RATE PTC W/ 10 PSI DCV	57.62	QJ-VR-X0.5-3/8-SS	VARIABLE RATE HOSE BARB/YELLOW X0.5	55.94
PTC-VR-X2.0-3/8-2	X2.0 VARIABLE RATE PTC W/ 2 PSI DCV	57.62	QJ-VR-X0.5-5/16-SS	VARIABLE RATE HOSE BARB/YELLOW X0.5	55.94
PTC-VR-X2.0-3/8-5	X2.0 VARIABLE RATE PTC W/ 5 PSI DCV	57.62	QJ-VR-X1.0	VARIABLE RATE QJ LESS HOSE BARB/RED X1.0	34.53
PTC-VR-X2.0-5/16	VARIABLE RATE PTC/LIGHT BLUE X2.0	40.13	QJ-VR-X1.0-1/4-SS	VARIABLE RATE HOSE BARB/RED X1.0	55.94
PTC-VR-X2.0-5/16-10	X2.0 VARIABLE RATE PTC W/ 10 PSI DCV	57.62	QJ-VR-X1.0-3/8-NYB	VARIABLE RATE HOSE BARB/RED X1.0	41.43
PTC-VR-X2.0-5/16-2	X2.0 VARIABLE RATE PTC W/ 2 PSI DCV	57.62	QJ-VR-X1.0-3/8-SS	VARIABLE RATE HOSE BARB/RED X1.0	55.94
PTC-VR-X2.0-5/16-5	X2.0 VARIABLE RATE PTC W/ 5 PSI DCV	57.62	QJ-VR-X1.0-5/16-SS	VARIABLE RATE HOSE BARB/RED X1.0	55.94
PW4000A	GUNJET SPRAY GUN	94.98	QJ-VR-X2.0	VARIABLE RATE QJ LESS HOSE BARB/LIGHT BLUE X2.0	34.53
PW4000A-1/4X1/4	GUNJET SPRAY GUN	94.98	QJ-VR-X2.0-1/2-NYB	VARIABLE RATE HOSE BARB/LIGHT BLUE X2.0	41.43
PW4000A-3/8X3/8	GUNJET SPRAY GUN	94.98	QJ-VR-X2.0-1/2-SS	VARIABLE RATE HOSE BARB/LIGHT BLUE X2.0	55.94
PW4000AS-3/8X3/8	GUNJET SPRAY GUN	129.45	QJ-VR-X2.0-3/8-NYB	VARIABLE RATE HOSE BARB/LIGHT BLUE X2.0	41.43
QC363-NYB	363 3 OUTLET, QC	23.30	QJ-VR-X2.0-3/8-SS	VARIABLE RATE HOSE BARB/LIGHT BLUE X2.0	55.94
QC363-NYB-VI	363 3 OUTLET, QC,VI	26.84	QJ-W-PP	WILGER CAP ADAPTER ASSEMBLY	4.22
QC364-NYB	364 4 OUTLET, QC	23.30	QJ-W-PP-10X	TEEJET / WILGER CAP ADAPTER - 10 PACK	41.24
QC364-NYB-VI	364 4 OUTLET, QC,VI	26.84	QJ1/4T-NYB	QJ-1/4T QUICKJT,BODY	4.14
QC365-NYB	365 5 OUTLET, QC	23.30	QJ1/4TT-NYB	QUICK CONN.BODY NY.	4.14
			QJ1/4TTJ02-VS-C90	90 DEG. QJ TURFJET -VS ASSEMBLY	32.88
			QJ1/4TTJ02-VS-C90-VI	VITON 90 DEG QJ TURFJET VS ASSMBLY	35.29
			QJ1/4TTJ04-VS-C90	90 DEG. QJ TURFJET - VS ASSEMBLY	32.88
			QJ1/4TTJ04-VS-C90-VI	VITON 90 DEG QJ TURFJET VS ASSMBLY	35.29
			QJ1/4TTJ05-VS-C90	90 DEG. QJ TURFJET - VS ASSEMBLY	32.88

PART NO.	DESCRIPTION	U.S.DOLLARS	PART NO.	DESCRIPTION	U.S.DOLLARS
QJ1/4TTJ05-VS-C90-VI	VITON 90 DEG QJ TURFJET VS ASSMBLY	35.29	QJ114430-1/4-2	PTC X PTC ASSM - 1/4 2#	24.34
QJ1/4TTJ06-VP-C90	90 DEG. QJ TURFJET - VP ASSEMBLY	20.56	QJ114430-1/4-5	PTC X PTC ASSM - 1/4 5#	24.34
QJ1/4TTJ06-VP-C90-VI	VITON 90 DEG QJ TURFJET VP ASSMBLY	22.98	QJ114432-5/16-10	PTC X PTC ASSM - 5/16 10#	24.34
QJ1/4TTJ06-VS-C90	90 DEG. QJ TURFJET - VS ASSEMBLY	32.88	QJ114432-5/16-2	PTC X PTC ASSM - 5/16 2#	24.34
QJ1/4TTJ06-VS-C90-VI	VITON 90 DEG QJ TURFJET VS ASSMBLY	35.29	QJ114432-5/16-5	PTC X PTC ASSM - 5/16 5#	24.34
QJ1/4TTJ08-VP-C90	90 DEG. QJ TURFJET - VP ASSEMBLY	20.56	QJ114434-3/8-10	PTC X PTC ASSM 3/8 10#	24.34
QJ1/4TTJ08-VP-C90-VI	VITON 90 DEG QJ TURFJET VP ASSMBLY	22.98	QJ114434-3/8-2	PTC X PTC ASSM 3/8 2#	24.34
QJ1/4TTJ08-VS-C90	90 DEG. QJ TURFJET - VS ASSEMBLY	32.88	QJ114434-3/8-5	PTC X PTC ASSM 3/8 5#	24.34
QJ1/4TTJ08-VS-C90-VI	VITON 90 DEG QJ TURFJET VS ASSMBLY	35.29	QJ115825-3/16	JG QJ CAP 3/16	8.47
QJ1/4TTJ10-VP-C90	90 DEG. QJ TURFJET - VP ASSEMBLY	20.56	QJ116239-5-NYR	HOSE DROP NYLON	36.57
QJ1/4TTJ10-VP-C90-VI	VITON 90 DEG QJ TURFJET VP ASSMBLY	22.98	QJ17560A-1-AC3	SPL EYL W/55300 AIR CHMSVR	51.67
QJ1/4TTJ10-VS-C90	90 DEG. QJ TURFJET - VS ASSEMBLY	32.88	QJ17560A-1-ES-12	SPL EYL W ECS-ES	173.84
QJ1/4TTJ10-VS-C90-VI	VITON 90 DEG QJ TURFJET VS ASSMBLY	35.29	QJ17560A-1-MC	SPL EYL W MNL CHMSVR	13.00
QJ1/4TTJ15-VP-C90	90 DEG. QJ TURFJET - VP ASSEMBLY	20.56	QJ17560A-1-NYB	QUICK SPL.EYL.CK.VLV	4.58
QJ1/4TTJ15-VP-C90-VI	VITON 90 DEG QJ TURFJET VP ASSMBLY	22.98	QJ17560A-1-NYB-VI	QUICK SPL.EYL.CK.VLV	5.34
QJ1/4TTJ15-VS-C90	90 DEG. QJ TURFJET - VS ASSEMBLY	32.88	QJ17560A-1/2-AC3	SPL EYL W/55300 AIR CHMSVR	51.67
QJ1/4TTJ15-VS-C90-VI	VITON 90 DEG QJ TURFJET VS ASSMBLY	35.29	QJ17560A-1/2-ES-12	SPL EYL W ECS-ES	173.84
QJ111-1	VARI-QUICK,CLAMP ASB	4.01	QJ17560A-1/2-MC	SPL EYL W MNL CHMSVR	13.00
QJ111-1-1/4	VARI-QUICK,CLAMP ASB	4.01	QJ17560A-1/2-NYB	QUICK SPL.EYL.CK.VLV	4.58
QJ111-1/2	VARI-QUICK,CLAMP ASB	4.01	QJ17560A-1/2-NYB-VI	QUICK SPL.EYL.CK.VLV	5.34
QJ111-3/4	VARI-QUICK,CLAMP ASB	4.01	QJ17560A-1/2X7-AC3	SPL EYL W/55300 AIR CHMSVR	51.67
QJ111HP-3/4	3/4 HP CLAMP ASBLY	15.36	QJ17560A-1/2X7-ES-12	SPL EYL W ECS-ES	173.84
QJ111SQ-1	VARI-QUICK,CLAMP ASB	4.01	QJ17560A-1/2X7-MC	SPL EYL W MNL CHMSVR	13.00
QJ111SQ-1-1/2	VARI-QUICK,CLAMP ASB	4.01	QJ17560A-1/2X7-NYB	QJ SPL.EYL.CK.VALVE	4.58
QJ111SQ-1-1/2-304SS	VARI-QUICK CLAMP ASB	8.80	QJ17560A-1/2X7-NYB-VI	QJ DPH.CK.VALVE	5.34
QJ111SQ-1-1/4	VARI-QUICK,CLAMP ASB	4.01	QJ17560A-20MM-AC3	SPL EYL W/55300 AIR CHMSVR	51.67
QJ111SQ-1-1/4-304SS	VARI-QUICK CLAMP ASB	8.80	QJ17560A-20MM-ES-12	SPL EYL W ECS-ES	173.84
QJ111SQ-1-304SS	VARI-QUICK CLAMP ASB	8.80	QJ17560A-20MM-MC	SPL EYL W MNL CHMSVR	13.00
QJ111SQ-3/4	VARI-QUICK,CLAMP ASB	4.01	QJ17560A-20MM-NYB	QUICK SPL.EYL.CK.VLV	4.58
QJ111SQ-3/4-304SS	VARI-QUICK CLAMP ASB	8.80	QJ17560A-20MM-NYB-20	QUICK SPL.EYL 20 PSI	4.58
QJ114398-5/16	PTC QJ CAP 5/16" OD HOSE	8.47	QJ17560A-20MM-NYB-VI	QUICK SPL.EYL.CK.VLV	5.34
QJ114400-5/16-10	PTC BODY 10 PSI CHECK 5/16" OD HOSE	17.55	QJ17560A-20MM-NYB-VI-20	QUICK SPL.EYL VITON 20 PSI	5.34
QJ114400-5/16-2	PTC BODY 2 PSI CHECK 5/16" OD HOSE	17.55	QJ17560A-20MMX7-AC3	SPL EYL W/55300 AIR CHMSVR	51.67
QJ114400-5/16-5	PTC BODY 5 PSI CHECK 5/16" OD HOSE	17.55	QJ17560A-20MMX7-ES-12	SPL EYL W ECS-ES	173.84
QJ114401-5/16-10	PTC ASSEMBLY 10 PSI CHECK 5/16"OD HOSE	25.97	QJ17560A-20MMX7-MC	SPL EYL W MNL CHMSVR	13.00
QJ114401-5/16-2	PTC ASSEMBLY 2 PSI CHECK 5/16"OD HOSE	25.97	QJ17560A-20MMX7-NYB	QJ DPH. CK. VALVE	4.58
QJ114401-5/16-5	PTC ASSEMBLY 5 PSI CHECK 5/16"OD HOSE	25.97	QJ17560A-20MMX7-NYB-VI	QJ DPH.CK.VALVE	5.34
QJ114403-1/4	PTC 90 QJ CAP 1/4" OD HOSE (SWIVEL)	21.14	QJ17560A-25MM-AC3	SPL EYL W/55300 AIR CHMSVR	51.67
QJ114404-5/16	PTC 90 QJ CAP 5/16" OD HOSE (SWIVEL)	21.14	QJ17560A-25MM-ES-12	SPL EYL W ECS-ES	173.84
QJ114405-3/8	PTC 90 QJ CAP 3/8" OD HOSE (SWIVEL)	21.14	QJ17560A-25MM-MC	SPL EYL W MNL CHMSVR	13.00
QJ114430-1/4-10	PTC X PTC ASSM - 1/4 10#	24.34	QJ17560A-25MM-NYB	QUICK SPL.EYL.CK.VLV	4.58
			QJ17560A-25MM-NYB-VI	QUICK SPL.EYL.CK.VLV	5.34
			QJ17560A-3/4-AC3	SPL EYL W/55300 AIR CHMSVR	51.67
			QJ17560A-3/4-ES-12	SPL EYL W ECS-ES	173.84
			QJ17560A-3/4-MC	SPL EYL W MNL CHMSVR	13.00
			QJ17560A-3/4-NYB	QUICK SPL.EYL.CK.VLV	4.58
			QJ17560A-3/4-NYB-VI	QUICK SPL.EYL.CK.VLV	5.34
			QJ19185-NYB	DIAPH.QUICK TEEJET	23.06
			QJ19190-NYB	DIAPH.QUICK TEEJET	15.55
			QJ20858-1-NYB	QUICKJET SPLT.EYELET	72.14
			QJ22187-1-M-VI	SPL EYL W MAN CHMSVR, VITON	20.41
			QJ22187-1-NYB	QUICK SPL-EY.R.ANGLE	15.24
			QJ22187-1-NYB-VI	QUICK SPL-EY. R. ANGLE, VITON	17.21
			QJ22187-1/2-M-VI	SPL EYL W MAN CHMSVR, VITON	20.41
			QJ22187-1/2-NYB	QUICK SPL-EY.R.ANGLE	15.24
			QJ22187-1/2-NYB-VI	QUICK SPL-EY. R. ANGLE, VITON	17.21
			QJ22187-3/4-M-VI	SPL EYL W MAN CHMSVR, VITON	20.41
			QJ22187-3/4-NYB	QUICK SPL-EY.R.ANGLE	15.24
			QJ22187-3/4-NYB-VI	QUICK SPL-EY. R. ANGLE, VITON	17.21
			QJ22187-4-1/2-L-VI	QUICK SPL-EYE SPECIAL	17.21
			QJ22187-4-1/2-R-VI	QUICK SPL-EYE SPECIAL	17.21
			QJ24216B-1-AC3	TURRET NOZZLE W/55300	64.66
			QJ24216B-1-AC3-VI	TURRET NOZZLE VITON W/55300	66.65
			QJ24216B-1-EC-12	TURRET NOZZLE W/115880	280.06



PART NO.	DESCRIPTION	U.S.DOLLARS	PART NO.	DESCRIPTION	U.S.DOLLARS
QJ24216B-1-EC-12-VI	TURRET NOZZLE VITON W/115880	282.05	QJ363C-1/2X750-NYB	363C 3 OUTLET	29.09
QJ24216B-1-ES-12	TURRET NOZZLE W/116950	191.86	QJ363C-1/2X750-NYB-VI	363C 3 OUTLET,VITON	34.87
QJ24216B-1-ES-12-VI	TURRET NOZZLE VITON W/116950	193.85	QJ363C-1/2X7MM-NYB	363C 3 OUTLET 1/2"	23.30
QJ24216B-1-HF-12	TURRET NOZZLE W/116280	320.66	QJ363C-1/2X7MM-NYB-VI	363C 3 OUTLET 1/2 VI	26.84
QJ24216B-1-HF-12-VI	TURRET NOZZLE VITON W/116280	322.65	QJ363C-1000-1-NYB	363C 3 OUTLET	29.09
QJ24216B-1-NYB	TURRET NOZZLE	17.55	QJ363C-1000-1-NYB-VI	363C 3 OUTLET,VITON	34.87
QJ24216B-1-NYB-VI	TURRET NOZZLE VITON	19.54	QJ363C-1000-1R-NYB	363C 3 OUTLET	29.09
QJ24216B-1/2-AC3	TURRET NOZZLE W/55300	64.66	QJ363C-1000-1R-NYB-VI	363C 3 OUTLET,VITON	34.87
QJ24216B-1/2-AC3-VI	TURRET NOZZLE VITON W/55300	66.65	QJ363C-1000-2-NYB	363C 3 OUTLET	29.09
QJ24216B-1/2-EC-12	TURRET NOZZLE W/115880	280.06	QJ363C-1000-2-NYB-VI	363C 3 OUTLET,VITON	34.87
QJ24216B-1/2-EC-12-VI	TURRET NOZZLE VITON W/115880	282.05	QJ363C-25MM-NYB	363C 3 OUTLET 25MM	23.30
QJ24216B-1/2-ES-12	TURRET NOZZLE W/116950	191.86	QJ363C-25MM-NYB-VI	363C 3 OUTLET VITON	26.84
QJ24216B-1/2-ES-12-VI	TURRET NOZZLE VITON W/116950	193.85	QJ363C-3/4-NYB	363C 3 OUTLET 3/4"	23.30
QJ24216B-1/2-HF-12	TURRET NOZZLE W/116280	320.66	QJ363C-3/4-NYB-VI	363C 3 OUTLET 3/4 VI	26.84
QJ24216B-1/2-HF-12-VI	TURRET NOZZLE VITON W/116280	322.65	QJ363C-500-1-NYB	363C 3 OUTLET	29.09
QJ24216B-1/2-NYB	TURRET NOZZLE	17.55	QJ363C-500-1-NYB-VI	363C 3 OUTLET,VITON	34.87
QJ24216B-1/2-NYB-VI	TURRET NOZZLE VITON	19.54	QJ363C-500-1R-NYB	363C 3 OUTLET	29.09
QJ24216B-20MM-AC3	TURRET NOZZLE W/55300	64.66	QJ363C-500-1R-NYB-VI	363C 3 OUTLET,VITON	34.87
QJ24216B-20MM-AC3-VI	TURRET NOZZLE VITON W/55300	66.65	QJ363C-500-2-NYB	363C 3 OUTLET	29.09
QJ24216B-20MM-EC-12	TURRET NOZZLE W/115880	280.06	QJ363C-500-2-NYB-VI	363C 3 OUTLET,VITON	34.87
QJ24216B-20MM-EC-12-VI	TURRET NOZZLE VITON W/115880	282.05	QJ363C-750-1-NYB	363C 3 OUTLET	29.09
QJ24216B-20MM-ES-12	TURRET NOZZLE W/116950	191.86	QJ363C-750-1-NYB-VI	363C 3 OUTLET,VITON	34.87
QJ24216B-20MM-ES-12-VI	TURRET NOZZLE VITON W/116950	193.85	QJ363C-750-1R-NYB	363C 3 OUTLET	29.09
QJ24216B-20MM-HF-12	TURRET NOZZLE W/116280	320.66	QJ363C-750-1R-NYB-VI	363C 3 OUTLET,VITON	34.87
QJ24216B-20MM-HF-12-VI	TURRET NOZZLE VITON W/116280	322.65	QJ363C-750-2-NYB	363C 3 OUTLET	29.09
QJ24216B-20MM-NYB	TURRET NOZZLE	17.55	QJ363C-750-2-NYB-VI	363C 3 OUTLET,VITON	34.87
QJ24216B-20MM-NYB-VI	TURRET NOZZLE VITON	19.54	QJ363E-20MM-NYB	363E 3 OUTLET 20MM	23.30
QJ24216B-25MM-AC3	TURRET NOZZLE W/55300	64.66	QJ363E-20MM-NYB-VI	363E 3 OUTLET VITON	26.84
QJ24216B-25MM-AC3-VI	TURRET NOZZLE VITON W/55300	66.65	QJ363F-1-NYB	363F 3 OUTLET 1"	29.07
QJ24216B-25MM-EC-12	TURRET NOZZLE W/115880	280.06	QJ363F-1-NYB-VI	363F 3 OUTLET 1" VI	35.50
QJ24216B-25MM-EC-12-VI	TURRET NOZZLE VITON W/115880	282.05	QJ363F-1000-1-NYB	3 OUTLET SINGLE	34.87
QJ24216B-25MM-ES-12	TURRET NOZZLE W/116950	191.86	QJ363F-1000-1-NYB-VI	3 OUTLET SINGLE VI	41.86
QJ24216B-25MM-ES-12-VI	TURRET NOZZLE VITON W/116950	193.85	QJ363F-1000-2-NYB	3 OUTLET DOUBLE	34.87
QJ24216B-25MM-HF-12	TURRET NOZZLE W/116280	320.66	QJ363F-1000-2-NYB-VI	3 OUTLET DOUBLE VI	41.86
QJ24216B-25MM-HF-12-VI	TURRET NOZZLE VITON W/116280	322.65	QJ364C-1-NYB	364C 4 OUTLET 1"	23.30
QJ24216B-25MM-NYB	TURRET NOZZLE	17.55	QJ364C-1-NYB-VI	364C 4 OUTLET 1" VIT	26.84
QJ24216B-25MM-NYB-VI	TURRET NOZZLE VITON	19.54	QJ364C-1/2-NYB	364C 4 OUTLET 1/2"	23.30
QJ24216B-3/4-AC3	TURRET NOZZLE W/55300	64.66	QJ364C-1/2-NYB-VI	364C 4 OUTLET VITON	26.84
QJ24216B-3/4-AC3-VI	TURRET NOZZLE VITON W/55300	66.65	QJ364C-1/2X750-NYB	364C 4 OUTLET	29.09
QJ24216B-3/4-EC-12	TURRET NOZZLE W/115880	280.06	QJ364C-1/2X750-NYB-VI	364C 4 OUTLET,VITON	34.87
QJ24216B-3/4-EC-12-VI	TURRET NOZZLE VITON W/115880	282.05	QJ364C-1/2X7MM-NYB	364C 4 OUTLET 1/2"	23.30
QJ24216B-3/4-ES-12	TURRET NOZZLE W/116950	191.86	QJ364C-1/2X7MM-NYB-VI	364C 4 OUTLET 1/2 VI	26.84
QJ24216B-3/4-ES-12-VI	TURRET NOZZLE VITON W/116950	193.85	QJ364C-1000-1-NYB	364C 4 OUTLET	29.09
QJ24216B-3/4-HF-12	TURRET NOZZLE W/116280	320.66	QJ364C-1000-1-NYB-VI	364C 4 OUTLET,VITON	34.87
QJ24216B-3/4-HF-12-VI	TURRET NOZZLE VITON W/116280	322.65	QJ364C-1000-1R-NYB	364C 4 OUTLET	29.09
QJ24216B-3/4-NYB	TURRET NOZZLE	17.55	QJ364C-1000-1R-NYB-VI	364C 4 OUTLET,VITON	34.87
QJ24216B-3/4-NYB-VI	TURRET NOZZLE VITON	19.54	QJ364C-1000-2-NYB	364C 4 OUTLET	29.09
QJ363C-1-NYB	363C 3 OUTLET 1"	23.30	QJ364C-1000-2-NYB-VI	364C 4 OUTLET,VITON	34.87
QJ363C-1-NYB-VI	363C 3 OUTLET 1"VITN	26.84	QJ364C-25MM-NYB	364C 4 OUTLET 25MM	23.30
QJ363C-1/2-NYB	363C 3 OUTLET 1/2"	23.30	QJ364C-25MM-NYB-VI	364C 4 OUTLET VITON	26.84
QJ363C-1/2-NYB-VI	363C 3 OUTLET VITON	26.84	QJ364C-3/4-NYB	364C 4 OUTLET 3/4"	23.30
QJ363C-1/2-NYB-VI	363C 3 OUTLET VITON	26.84	QJ364C-3/4-NYB-VI	364C 4 OUTLET 3/4 VI	26.84
			QJ364C-500-1-NYB	364C 4 OUTLET	29.09
			QJ364C-500-1-NYB-VI	364C 4 OUTLET,VITON	34.87
			QJ364C-500-1R-NYB	364C 4 OUTLET	29.09
			QJ364C-500-1R-NYB-VI	364C 4 OUTLET,VITON	34.87
			QJ364C-500-2-NYB	364C 4 OUTLET	29.09
			QJ364C-500-2-NYB-VI	364C 4 OUTLET,VITON	34.87
			QJ364C-750-1-NYB	364C 4 OUTLET	29.09
			QJ364C-750-1-NYB-VI	364C 4 OUTLET,VITON	34.87
			QJ364C-750-1R-NYB	364C 4 OUTLET	29.09
			QJ364C-750-1R-NYB-VI	364C 4 OUTLET,VITON	34.87
			QJ364C-750-2-NYB	364C 4 OUTLET	29.09
			QJ364C-750-2-NYB-VI	364C 4 OUTLET,VITON	34.87

PART NO.	DESCRIPTION	U.S.DOLLARS	PART NO.	DESCRIPTION	U.S.DOLLARS
QJ364E-20MM-NYB	364E 4 OUTLET 20MM	23.30	QJ373-1000-1-NYB	373 DRY BOOM 3 OUTLET 1" VITON	19.68
QJ364E-20MM-NYB-VI	364E 4 OUTLET VITON	26.84	QJ373-1000-1R-6-NYB	373 DRY BOOM 3 OUTLET 1" VITON 6MM	19.68
QJ364F-1-NYB	364F 4 OUTLET 1"	29.07	QJ373-1000-1R-NYB	373 DRY BOOM 3 OUTLET 1" VITON	19.68
QJ364F-1-NYB-VI	364F 4 OUTLET 1" VI	35.50	QJ373-1000-2-6-NYB	373 DRY BOOM 3 OUTLET 1" VITON 6MM	19.68
QJ364F-1000-1-NYB	4 OUTLET SINGLE	34.87	QJ373-1000-2-NYB	373 DRY BOOM 3 OUTLET 1" VITON	19.68
QJ364F-1000-1-NYB-VI	4 OUTLET SINGLE VI	41.86	QJ373-20MM-6-NYB	373 WET BOOM 3 OUTLET 20MM VITON 6MM	14.65
QJ364F-1000-2-NYB	4 OUTLET DOUBLE	34.87	QJ373-20MM-AC3	QJ373 W/55300 ACS	67.59
QJ364F-1000-2-NYB-VI	4 OUTLET DOUBLE VI	41.86	QJ373-20MM-EC-12	QJ373 W/115880 12V ECS	279.33
QJ365C-1-NYB	365C 5 OUTLET 1"	23.30	QJ373-20MM-EC-24	QJ373 W/55295 24V ECS	279.33
QJ365C-1-NYB-VI	365C 5 OUTLET 1" VIT	26.84	QJ373-20MM-ES-12	QJ373 W/ 116950 12V ES	191.13
QJ365C-1/2-NYB	365C 5 OUTLET 1/2"	23.30	QJ373-20MM-NYB	(373 WET BOOM 3 OUTLET 20 MM VITON)	14.65
QJ365C-1/2-NYB-VI	365C 5 OUTLET VITON	26.84	QJ373-25MM-6-NYB	373 WET BOOM 3 OUTLET 25MM VITON 6MM	14.65
QJ365C-1/2X750-NYB	365C 5 OUTLET	29.09	QJ373-25MM-AC3	QJ373 W/55300 ACS	67.59
QJ365C-1/2X750-NYB-VI	365C 5 OUTLET,VITON	34.87	QJ373-25MM-EC-12	QJ373 W/115880 12V ECS	279.33
QJ365C-1/2X7MM-NYB	365C 5 OUTLET 1/2"	23.30	QJ373-25MM-EC-24	QJ373 W/55295 24V ECS	279.33
QJ365C-1/2X7MM-NYB-VI	365C 5 OUTLET 1/2 VI	26.84	QJ373-25MM-ES-12	QJ373 W/ 116950 12V ES	191.13
QJ365C-1000-1-NYB	365C 5 OUTLET	29.09	QJ373-25MM-NYB	373 WET BOOM 3 OUTLET 25 MM VITON	14.65
QJ365C-1000-1-NYB-VI	365C 5 OUTLET,VITON	34.87	QJ373-28MM-6-NYB	373 WET BOOM 3 OUTLET 25MM VITON 6MM	14.65
QJ365C-1000-1R-NYB	365C 5 OUTLET	29.09	QJ373-28MM-AC3	QJ373 W/55300 ACS	67.59
QJ365C-1000-1R-NYB-VI	365C 5 OUTLET,VITON	34.87	QJ373-28MM-EC-12	QJ373 W/55295 12V ECS	279.33
QJ365C-1000-2-NYB	365C 5 OUTLET	29.09	QJ373-28MM-EC-24	QJ373 W/55295 24V ECS	279.33
QJ365C-1000-2-NYB-VI	365C 5 OUTLET,VITON	34.87	QJ373-28MM-ES-12	QJ373 W/ 116950 12V ES	191.13
QJ365C-25MM-NYB	365C 5 OUTLET 25MM	23.30	QJ373-28MM-NYB	373 WET BOOM 3 OUTLET 28 MM VITON	14.65
QJ365C-25MM-NYB-VI	QJ365C 5 OUTLET VI	26.84	QJ373-3/4-6-NYB	373 WET BOOM 3 OUTLET 3/4" VITON 6MM	14.65
QJ365C-3/4-NYB	365C 5 OUTLET 3/4"	23.30	QJ373-3/4-AC3	QJ373 W/55300 ACS	67.59
QJ365C-3/4-NYB-VI	365C 5 OUTLET 3/4 VI	26.84	QJ373-3/4-EC-12	QJ373 W/115880 12V ECS	279.33
QJ365C-500-1-NYB	365C 5 OUTLET	29.09	QJ373-3/4-EC-24	QJ373 W/55295 24V ECS	279.33
QJ365C-500-1-NYB-VI	365C 5 OUTLET,VITON	34.87	QJ373-3/4-ES-12	QJ373 W/ 116950 12V ES	191.13
QJ365C-500-1R-NYB	365C 5 OUTLET	29.09	QJ373-3/4-NYB	373 WET BOOM 3 OUTLET 3/4" VITON	14.65
QJ365C-500-1R-NYB-VI	365C 5 OUTLET,VITON	34.87	QJ373-500-1-6-NYB	373 DRY BOOM 3 OUTLET 1/2" VITON 6MM	19.68
QJ365C-500-2-NYB	365C 5 OUTLET	29.09	QJ373-500-1-NYB	373 DRY BOOM 3 OUTLET 1/2" VITON	19.68
QJ365C-500-2-NYB-VI	365C 5 OUTLET, VITON	34.87	QJ373-500-1R-6-NYB	373 DRY BOOM 3 OUTLET 1/2" VITON 6MM	19.68
QJ365C-750-1-NYB	365C 5 OUTLET	29.09	QJ373-500-1R-NYB	373 DRY BOOM 3 OUTLET 1/2" VITON	19.68
QJ365C-750-1-NYB-VI	365C 5 OUTLET,VITON	34.87	QJ373-500-2-6-NYB	373 DRY BOOM 3 OUTLET 1/2" VITON 6MM	19.68
QJ365C-750-1R-NYB	365C 5 OUTLET	29.09	QJ373-500-2-NYB	373 DRY BOOM 3 OUTLET 1/2" VITON	19.68
QJ365C-750-1R-NYB-VI	365C 5 OUTLET,VITON	34.87	QJ373-750-1-6-NYB	373 DRY BOOM 3 OUTLET 3/4" VITON 6MM	19.68
QJ365C-750-2-NYB	365C 5 OUTLET	29.09	QJ373-750-1-NYB	373 DRY BOOM 3 OUTLET 3/4" VITON	19.68
QJ365C-750-2-NYB-VI	365C 5 OUTLET,VITON	34.87	QJ373-750-1R-6-NYB	373 DRY BOOM 3 OUTLET 3/4" VITON 6MM	19.68
QJ365E-20MM-NYB	365E 5 OUTLET 20MM	23.30	QJ373-750-1R-NYB	373 DRY BOOM 3 OUTLET 3/4" VITON	19.68
QJ365E-20MM-NYB-VI	365E 5 OUTLET VITON	26.84	QJ373-750-2-6-NYB	373 DRY BOOM 3 OUTLET 3/4" VITON 6MM	19.68
QJ365F-1-NYB	365F 5 OUTLET 1"	29.07	QJ373-750-2-NYB	373 DRY BOOM 3 OUTLET 3/4" VITON	19.68
QJ365F-1-NYB-VI	365F 5 OUTLET 1" VI	35.50	QJ373-L-1-6-NYB	373 WET BOOM 3 OUTLET 1" VITON 6MM - LEFT SIDE DCV	15.91
QJ365F-1000-1-NYB	5 OUTLET SINGLE	34.87			
QJ365F-1000-1-NYB-VI	5 OUTLET SINGLE VI	41.86			
QJ365F-1000-2-NYB	5 OUTLET DOUBLE	34.87			
QJ365F-1000-2-NYB-VI	5 OUTLET DOUBLE VI	41.86			
QJ373-1-6-NYB	373 WET BOOM 3 OUTLET 1" VITON 6MM	14.65			
QJ373-1-AC3	QJ373 W/55300 ACS	67.59			
QJ373-1-EC-12	QJ373 W/115880 12V ECS	279.33			
QJ373-1-EC-24	QJ373 W/55295 24V ECS	279.33			
QJ373-1-ES-12	QJ373 W/ 116950 12V ES	191.13			
QJ373-1-NYB	373 WET BOOM 3 OUTLET 1" VITON	14.65			
QJ373-1/2-6-NYB	373 WET BOOM 3 OUTLET 1/2" VITON 6MM	14.65			
QJ373-1/2-AC3	QJ373 W/55300 ACS	67.59			
QJ373-1/2-EC-12	QJ373 W/115880 12V ECS	279.33			
QJ373-1/2-EC-24	QJ373 W/55295 24V ECS	279.33			
QJ373-1/2-ES-12	QJ373 W/ 116950 12V ES	191.13			
QJ373-1/2-NYB	373 WET BOOM 3 OUTLET 1/2" VITON	14.65			
QJ373-1000-1-6-NYB	373 DRY BOOM 3 OUTLET 1" VITON 6MM	19.68			

PART NO.	DESCRIPTION	U.S.DOLLARS	PART NO.	DESCRIPTION	U.S.DOLLARS
QJ373-L-1-AC3	TURRET NOZZLE W/55300 AIR CHMSVR	67.59	QJ375-1000-1-6-NYB	375 DRY BOOM 5 OUTLET 1" VITON 6MM	19.68
QJ373-L-1-EC-12	QJ373 W/ 12 ECS	279.33	QJ375-1000-1-NYB	375 DRY BOOM 5 OUTLET 1" VITON	19.68
QJ373-L-1-EC-24	QJ373 W/ 24 ECS	279.33	QJ375-1000-1R-6-NYB	375 DRY BOOM 5 OUTLET 1" VITON 6MM	19.68
QJ373-L-1-ES-12	QJ373 W/ 116950 12V ES	191.13	QJ375-1000-1R-NYB	375 DRY BOOM 5 OUTLET 1" VITON	19.68
QJ373-L-1-NYB	373 WET BOOM 3 OUTLET 1" VITON - LEFT SIDE DCV	15.91	QJ375-1000-2-6-NYB	375 DRY BOOM 5 OUTLET 1" VITON 6MM	19.68
QJ373-L-1/2-6-NYB	373 WET BOOM 3 OUTLET 1/2" VITON 6MM - LEFT SIDE DCV	15.91	QJ375-1000-2-NYB	375 DRY BOOM 5 OUTLET 1" VITON	19.68
QJ373-L-1/2-AC3	TURRET NOZZLE W/55300 AIR CHMSVR	67.59	QJ375-20MM-6-NYB	375 WET BOOM 5 OUTLET 20MM VITON 6MM	14.65
QJ373-L-1/2-EC-12	QJ373 W/ 12 ECS	279.33	QJ375-20MM-EC-12	QJ375 W/115880 12V ECS	279.33
QJ373-L-1/2-EC-24	QJ373 W/ 24 ECS	279.33	QJ375-20MM-EC-24	QJ375 W/55295 24V ECS	279.33
QJ373-L-1/2-ES-12	QJ373 W/ 116950 12V ES	191.13	QJ375-20MM-ES-12	QJ375 W/ 116950 12V ES	191.13
QJ373-L-1/2-NYB	373 WET BOOM 3 OUTLET 1/2" VITON - LEFT SIDE DCV	15.91	QJ375-20MM-NYB	375 WET BOOM 5 OUTLET 20MM VITON	14.65
QJ373-L-20MM-6-NYB	373 WET BOOM 3 OUTLET 20MM VITON 6MM - LEFT SIDE DCV	15.91	QJ375-25MM-6-NYB	375 WET BOOM 5 OUTLET 25MM VITON 6MM	14.65
QJ373-L-20MM-AC3	TURRET NOZZLE W/55300 AIR CHMSVR	67.59	QJ375-25MM-AC3	QJ375 W/55300 ACS	67.59
QJ373-L-20MM-EC-12	QJ373 W/ 12 ECS	279.33	QJ375-25MM-EC-12	QJ375 W/115880 12V ECS	279.33
QJ373-L-20MM-EC-24	QJ373 W/ 24 ECS	279.33	QJ375-25MM-EC-24	QJ375 W/55295 24V ECS	279.33
QJ373-L-20MM-ES-12	QJ373 W/ 116950 12V ES	191.13	QJ375-25MM-ES-12	QJ375 W/ 116950 12V ES	191.13
QJ373-L-20MM-NYB	373 WET BOOM 3 OUTLET 20MM VITON - LEFT SIDE DCV	15.91	QJ375-25MM-NYB	375 WET BOOM 5 OUTLET 25 MM VITON	14.65
QJ373-L-25MM-6-NYB	373 WET BOOM 3 OUTLET 25MM VITON 6MM - LEFT SIDE DCV	15.91	QJ375-28MM-AC3	QJ375 W/55300 ACS	67.59
QJ373-L-25MM-AC3	TURRET NOZZLE W/55300 AIR CHMSVR	67.59	QJ375-28MM-EC-12	QJ375 W/55295 12V ECS	279.33
QJ373-L-25MM-EC-12	QJ373 W/ 12 ECS	279.33	QJ375-28MM-EC-24	QJ375 W/55295 24V ECS	279.33
QJ373-L-25MM-EC-24	QJ373 W/ 24 ECS	279.33	QJ375-28MM-ES-12	QJ375 W/ 116950 12V ES	191.13
QJ373-L-25MM-ES-12	QJ373 W/ 116950 12V ES	191.13	QJ375-28MM-NYB	375 WET BOOM 5 OUTLET 28 MM VITON	14.65
QJ373-L-25MM-NYB	373 WET BOOM 3 OUTLET 25MM VITON - LEFT SIDE DCV	15.91	QJ375-3/4-6-NYB	375 WET BOOM 5 OUTLET 3/4" VITON 6MM	14.65
QJ373-L-28MM-AC3	TURRET NOZZLE W/55300 AIR CHMSVR	67.59	QJ375-3/4-AC3	QJ375 W/55300 ACS	67.59
QJ373-L-28MM-EC-12	QJ373 W/ 12 ECS	279.33	QJ375-3/4-EC-12	QJ375 W/115880 12V ECS	279.33
QJ373-L-28MM-EC-24	QJ373 W/ 24 ECS	279.33	QJ375-3/4-EC-24	QJ375 W/55295 24V ECS	279.33
QJ373-L-28MM-ES-12	QJ373 W/ 116950 12V ES	191.13	QJ375-3/4-ES-12	QJ375 W/ 116950 12V ES	191.13
QJ373-L-28MM-NYB	373 WET BOOM 3 OUTLET 25MM VITON - LEFT SIDE DCV	15.91	QJ375-3/4-NYB	375 WET BOOM 5 OUTLET 3/4" VITON	14.65
QJ373-L-3/4-6-NYB	373 WET BOOM 3 OUTLET 3/4" VITON 6MM - LEFT SIDE DCV	15.91	QJ375-500-1-6-NYB	375 DRY BOOM 5 OUTLET 1/2" VITON 6MM	19.68
QJ373-L-3/4-AC3	TURRET NOZZLE W/55300 AIR CHMSVR	67.59	QJ375-500-1-NYB	375 DRY BOOM 5 OUTLET 1/2" VITON	19.68
QJ373-L-3/4-EC-12	QJ373 W/ 12 ECS	279.33	QJ375-500-1R-6-NYB	375 DRY BOOM 5 OUTLET 1/2" VITON 6MM	19.68
QJ373-L-3/4-EC-24	QJ373 W/ 24 ECS	279.33	QJ375-500-1R-NYB	375 DRY BOOM 5 OUTLET 1/2" VITON	19.68
QJ373-L-3/4-ES-12	QJ373 W/ 116950 12V ES	191.13	QJ375-500-2-6-NYB	375 DRY BOOM 5 OUTLET 1/2" VITON 6MM	19.68
QJ373-L-3/4-NYB	373 WET BOOM 3 OUTLET 3/4" VITON - LEFT SIDE DCV	15.91	QJ375-500-2-NYB	375 DRY BOOM 5 OUTLET 1/2" VITON	19.68
QJ375-1-6-NYB	375 WET BOOM 5 OUTLET 1" VITON 6MM	14.65	QJ375-750-1-6-NYB	375 DRY BOOM 5 OUTLET 3/4" VITON 6MM	19.68
QJ375-1-AC3	QJ375 W/55300 ACS	67.59	QJ375-750-1-NYB	375 DRY BOOM 5 OUTLET 3/4" VITON	19.68
QJ375-1-EC-12	QJ375 W/115880 12V ECS	279.33	QJ375-750-1R-6-NYB	375 DRY BOOM 5 OUTLET 3/4" VITON 6MM	19.68
QJ375-1-EC-24	QJ375 W/55295 24V ECS	279.33	QJ375-750-1R-NYB	375 DRY BOOM 5 OUTLET 3/4" VITON	19.68
QJ375-1-ES-12	QJ375 W/ 116950 12V ES	191.13	QJ375-750-2-6-NYB	375 DRY BOOM 5 OUTLET 3/4" VITON 6MM	19.68
QJ375-1-NYB	375 WET BOOM 5 OUTLET 1" VITON	14.65	QJ375-750-2-NYB	375 DRY BOOM 5 OUTLET 3/4" VITON	19.68
QJ375-1/2-6-NYB	375 WET BOOM 5 OUTLET 1/2" VITON 6MM	14.65	QJ375-L-1-6-NYB	375 WET BOOM 5 OUTLET 1" - LEFT SIDE DCV VITON 6MM	15.91
QJ375-1/2-AC3	QJ375 W/55300 ACS	67.59			
QJ375-1/2-EC-12	QJ375 W/115880 12V ECS	279.33			
QJ375-1/2-EC-24	QJ375 W/55295 24V ECS	279.33			
QJ375-1/2-ES-12	QJ375 W/ 116950 12V ES	191.13			
QJ375-1/2-NYB	375 WET BOOM 5 OUTLET 1/2" VITON	14.65			

PART NO.	DESCRIPTION	U.S.DOLLARS	PART NO.	DESCRIPTION	U.S.DOLLARS
QJ375-L-1-AC3	TURRET NOZZLE W/55300 AIR CHMSVR	67.59	QJ38620A-25MM-NYB	QK SPL-EYE CK.VLV.LP	6.55
QJ375-L-1-EC-12	QJ375 W/ 12 ECS	279.33	QJ38620A-3/4-NYB	QJ CK/VALVE,YELLOW	6.55
QJ375-L-1-EC-24	QJ375 W/ 24 ECS	279.33	QJ38621-NYB	DIA,QJ,TJ,YELLOW,LP	7.53
QJ375-L-1-ES-12	QJ375 W/ 116950 12V ES	191.13	QJ39684-1L-500-NYB	VARI QUICK TEEJET AS	10.11
QJ375-L-1-NYB	375 WET BOOM 5 OUTLET 1" VITON - LEFT SIDE DCV	15.91	QJ39684-1R-500-NYB	VARI QUICK TEEJET AS	10.11
QJ375-L-1/2-6-NYB	375 WET BOOM 5 OUTLET 1/2" - LEFT SIDE DCV VITON 6MM	15.91	QJ39684-2-500-NYB	VARI QUICK TEEJET AS	10.11
QJ375-L-1/2-AC3	TURRET NOZZLE W/55300 AIR CHMSVR	67.59	QJ39685-1L-3/8-NYB	3/8 PTC VARI-QUICK TEEJET	16.44
QJ375-L-1/2-EC-12	QJ375 W/ 12 ECS	279.33	QJ39685-1L-500-NYB	QUICK TEEJET	10.11
QJ375-L-1/2-EC-24	QJ375 W/ 24 ECS	279.33	QJ39685-1L-500-NYB-VI	QUICK TEEJET, VITON	11.60
QJ375-L-1/2-ES-12	QJ375 W/ 116950 12V ES	191.13	QJ39685-1R-3/8-NYB	3/8 PTC VARI-QUICK TEEJET	16.44
QJ375-L-1/2-NYB	375 WET BOOM 5 OUTLET 1/2" VITON - LEFT SIDE DCV	15.91	QJ39685-1R-500-NYB	QUICK TEEJET	10.11
QJ375-L-20MM-6-NYB	375 WET BOOM 5 OUTLET 20MM VITON - LEFT SIDE DCV VITON	15.91	QJ39685-1R-500-NYB-VI	QUICK TEEJET, VITON	11.60
QJ375-L-20MM-AC3	TURRET NOZZLE W/55300 AIR CHMSVR	67.59	QJ39685-2-3/8-NYB	3/8 PTC VARI-QUICK TEEJET	20.85
QJ375-L-20MM-EC-12	QJ375 W/ 12 ECS	279.33	QJ39685-2-500-NYB	QUICK TEEJET	10.11
QJ375-L-20MM-EC-24	QJ375 W/ 24 ECS	279.33	QJ39685-2-500-NYB-VI	QUICK TEEJET, VITON	11.60
QJ375-L-20MM-ES-12	QJ375 W/ 116950 12V ES	191.13	QJ45931-NYR	QUICKJET ADAPTER	8.37
QJ375-L-20MM-NYB	375 WET BOOM 5 OUTLET 20MM VITON - LEFT SIDE DCV	15.91	QJ4676-1/4-NYR	QJ4676 1/4 NPT CAP & WASHER, NY&EPR	3.54
QJ375-L-25MM-6-NYB	375 WET BOOM 5 OUTLET 25MM - LEFT SIDE DCV VITON 6MM	15.91	QJ4676-1/8-NYR	QJ4676 1/8 NPT CAP & WASHER, NY&EPR	3.54
QJ375-L-25MM-AC3	TURRET NOZZLE W/55300 AIR CHMSVR	67.59	QJ4676-45-1/4-NYR	QJ ADPT 45 DEGREE	6.70
QJ375-L-25MM-EC-12	QJ375 W/ 12 ECS	279.33	QJ4676-45-1/4-NYVI	QJ ADPT 45 DEGREE VI	9.12
QJ375-L-25MM-EC-24	QJ375 W/ 24 ECS	279.33	QJ4676-90-1/4-NYR	QJ ADPT 90 DEGREE	6.70
QJ375-L-25MM-ES-12	QJ375 W/ 116950 12V ES	191.13	QJ4676-90-1/4-NYVI	ADAPTER 90 DEGREE	9.12
QJ375-L-25MM-NYB	375 WET BOOM 5 OUTLET 25MM VITON - LEFT SIDE DCV	15.91	QJ7421-1-NYB	QUICKJET SPLT.EYELET	6.07
QJ375-L-25MM-AC3	TURRET NOZZLE W/55300 AIR CHMSVR	67.59	QJ7421-1/2-NYB	QUICKJET SPLT.EYELET,BLACK	6.07
QJ375-L-25MM-EC-12	QJ375 W/ 12 ECS	279.33	QJ7421-3/4-NYB	QUICKJET SPLT.EYELET,BLACK	6.07
QJ375-L-25MM-EC-24	QJ375 W/ 24 ECS	279.33	QJ8355-1/4-NYB	1/4 DIAPH. QUICK TJET NYB	15.11
QJ375-L-25MM-ES-12	QJ375 W/ 116950 12V ES	191.13	QJ8355-1/4-NYB-VI	1/4 DIAPH. QUICK TEEJET, VITON	16.58
QJ375-L-25MM-NYB	375 WET BOOM 5 OUTLET 25MM VITON - LEFT SIDE DCV	15.91	QJ8355-1/8-NYB	1/8 DIAPH. QUICK TJET NYB	15.11
QJ375-L-28MM-AC3	TURRET NOZZLE W/55300 AIR CHMSVR	67.59	QJ8355-1/8-NYB-VI	1/8 DIAPH. QUICK TEEJET, VITON	16.58
QJ375-L-28MM-EC-12	QJ375 W/ 12 ECS	279.33	QJ8355-8-1/4-NYB	DIAPH. QUICK TEEJET	15.11
QJ375-L-28MM-EC-24	QJ375 W/ 24 ECS	279.33	QJ8355-8-1/8-NYB	DIAPH. QUICK TEEJET	15.11
QJ375-L-28MM-ES-12	QJ375 W/ 116950 12V ES	191.13	QJ8360-1/4F-NYB	QJ8360-1/4F-NYB DIAPHRAGM QUICK TJT ASB.	8.20
QJ375-L-28MM-NYB	375 WET BOOM 5 OUTLET 28MM VITON - LEFT SIDE DCV	15.91	QJ8360-1/4F-NYB-VI	QJ8360-1/4F-NYB-VI DIAPHRAGM QUICK TJT ASB.	9.00
QJ375-L-3/4-6-NYB	375 WET BOOM 5 OUTLET 3/4" - LEFT SIDE DCV VITON 6MM	15.91	QJ8360-AC	8360 W/ AIR CHEM	60.24
QJ375-L-3/4-AC3	TURRET NOZZLE W/55300 AIR CHMSVR	67.59	QJ8360-NYB	DIAPH.QUICK TEEJET	7.53
QJ375-L-3/4-EC-12	QJ375 W/ 12 ECS	279.33	QJ8360-NYB-VI	QJ DIA CHECK VLV VIT	9.66
QJ375-L-3/4-EC-24	QJ375 W/ 24 ECS	279.33	QJ8600-1/4-NYB	QUICKJET SGL.SVL.NY.	11.00
QJ375-L-3/4-ES-12	QJ375 W/ 116950 12V ES	191.13	QJ8600-2-1/4-NYB	QUICKJET DBL.SVL.NY.	13.24
QJ375-L-3/4-NYB	375 WET BOOM 5 OUTLET 3/4" VITON - LEFT SIDE DCV	15.91	QJ90-1-NYR	ADAPTER W/EPR GASKET	6.70
QJ383-1-NYB	QJ383 1" QUICK TEEJET	46.08	QJ90-2-NYR	ADAPTER, NYLON	6.70
QJ383-1X11/16-NYB	QJ383 1" (11/16) QUICK TEEJET	55.90	QJ90-2XTT11001-VP	TT DUO QJ DBL OUTLET	29.20
QJ383-3/4-NYB	QJ383 3/4" QUICK TEEJET	46.08	QJ90-2XTT110015-VP	TT DUO QJ DBL OUTLET	29.20
QJ383-3/4X11/16-NYB	QJ383 3/4" (11/16) QUICK TEEJET	55.90	QJ90-2XTT11002-VP	TT DUO QJ DBL OUTLET	29.20
QJ383F-1-NYB	QJ383F- 1" QUICK TEEJET	50.30	QJ90-2XTT110025-VP	TT DUO QJ DBL OUTLET	29.20
QJ383F-1X11/16-NYB	QJ383F- 1" (11/16) QUICK TEEJET	60.13	QJ90-2XTT11003-VP	TT DUO QJ DBL OUTLET	29.20
QJ383F-3/4-NYB	QJ383F- 3/4" QUICK TEEJET	50.30	QJ90-2XTT11004-VP	TT DUO QJ DBL OUTLET	29.20
QJ383F-3/4X11/16-NYB	QJ383F- 3/4" (11/16) QUICK TEEJET	60.13	QJ90-2XTT11005-VP	TT DUO QJ DBL OUTLET	29.20
QJ38619-1-NYB	QK SPL-EYE R.ANGL.LP	15.24	QJ90-2XTT11006-VP	TT DUO QJ DBL OUTLET	29.20
QJ38619-1/2-NYB	QK SPL-EYE R.ANGL.LP	15.24	QJ90-2XTT11008-VP	TT DUO QJ DBL OUTLET	29.20
QJ38619-3/4-NYB	QK SPL-EYE R.ANGL.LP	15.24	QJ90-2XXR110015-VP	XR DUO QJ DBL OUTLET	18.83
QJ38620A-1-NYB	QK SPL-EYE CK.VLV.LP	6.55	QJ90-2XXR11002-VP	XR DUO QJ DBL OUTLET	18.83
QJ38620A-1/2-NYB	QK SPL-EYE CK.VLV.LP	6.55	QJ90-2XXR11003-VP	XR DUO QJ DBL OUTLET	18.83
QJ38620A-1/2-NYB-VI	QK SPL-EYE CK.VLV.LP	8.02	QJ90-2XXR11004-VP	XR DUO QJ DBL OUTLET	18.83
QJ38620A-20MM-NYB	QK SPL-EYE CK.VLV.LP	6.55	QJ90-2XXR11005-VP	XR DUO QJ DBL OUTLET	18.83
			QJ90-2XXR11006-VP	XR DUO QJ DBL OUTLET	18.83
			QJ90-2XXR11008-VP	XR DUO QJ DBL OUTLET	18.83
			QJ98586-3/8	PTC QJ CAP 3/8	8.47
			QJ98588-1/4	PTC QJ CAP 1/4	8.47
			QJ98590-3/8-10	PTC QJ BODY 3/8 10#	17.55
			QJ98590-3/8-2	PTC QJ BODY 3/8 2#	17.55

PART NO.	DESCRIPTION	U.S.DOLLARS	PART NO.	DESCRIPTION	U.S.DOLLARS
QJ98590-3/8-5	PTC QJ BODY 3/8 5#	17.55	QJS-B2-1-AA	QJS NOZZLE BODY	146.26
QJ98592-1/4-10	PTC QJ BODY 1/4 10#	17.55	QJS-B2-1-AC	QJS NOZZLE BODY	91.21
QJ98592-1/4-2	PTC QJ BODY 1/4 2#	17.55	QJS-B2-1-AM	QJS NOZZLE BODY	100.21
QJ98592-1/4-5	PTC QJ BODY 1/4 5#	17.55	QJS-B2-1-CC	QJS NOZZLE BODY	34.58
QJ98594-3/8-10	PTC QJ BODY/CAP 3/8 10#	25.97	QJS-B2-1-CE	QJS NOZZLE BODY	314.21
QJ98594-3/8-2	PTC QJ BODY/CAP 3/8 2#	25.97	QJS-B2-1-CM	QJS NOZZLE BODY	45.20
QJ98594-3/8-5	PTC QJ BODY/CAP 3/8 5#	25.97	QJS-B2-1-EA	QJS NOZZLE BODY	369.25
QJ98595-1/4-10	PTC QJ BODY/CAP 1/4 10#	25.97	QJS-B2-1-EM	QJS NOZZLE BODY	323.27
QJ98595-1/4-2	PTC QJ BODY/CAP 1/4 2#	25.97	QJS-B2-1-MC	QJS NOZZLE BODY	45.20
QJ98595-1/4-5	PTC QJ BODY/CAP 1/4 5#	25.97	QJS-B2-1-ME	QJS NOZZLE BODY	323.27
QJ98598-90-1/4	90 DEG. PUSH TO CONNECT CAP	10.57	QJS-B2-1-MM	QJS NOZZLE BODY	54.22
QJ98599-90-3/8	90 DEG. PUSH TO CONNECT CAP	10.57	QJS-B2-1-MX	QJS NOZZLE BODY	43.86
QJB1/4TT-NYB	QUICK CON.BODY.BSPT.	4.14	QJS-B2-1-XM	QJS NOZZLE BODY	43.86
QJB17560A-1-AC	NZL BODY W/AIR CHEM	57.63	QJS-B2-1/2-AA	QJS NOZZLE BODY	146.26
QJB17560A-1/2-AC	NZL BODY W/AIR CHEM	57.63	QJS-B2-1/2-AC	QJS NOZZLE BODY	91.21
QJB17560A-1/2X7-AC	NZL BODY W/AIR CHEM	57.63	QJS-B2-1/2-AE	QJS NOZZLE BODY	369.25
QJB17560A-20MM-AC	NZL BODY W/AIR CHEM	57.63	QJS-B2-1/2-CE	QJS NOZZLE BODY	314.21
QJB17560A-20MMX7-AC	NZL BODY W/AIR CHEM	57.63	QJS-B2-1/2-CM	QJS NOZZLE BODY	45.20
QJB17560A-25MM-AC	NZL BODY W/AIR CHEM	57.63	QJS-B2-1/2-EE	QJS NOZZLE BODY	585.05
QJB17560A-3/4-AC	NZL BODY W/AIR CHEM	57.63	QJS-B2-1/2-EM	QJS NOZZLE BODY	323.27
QJB22187-1-AC	SPL EYL W AIR CHMSVR	70.65	QJS-B2-1/2-MM	QJS NOZZLE BODY	54.22
QJB22187-1/2-AC	SPL EYL AIR CHMSVR	70.65	QJS-B2-1/2-XX	QJS NOZZLE BODY	33.47
QJB22187-3/4-AC	SPL EYL W AIR CHMSVR	70.65	QJS-B2-20MM-AA	QJS NOZZLE BODY	146.26
QJB363C-1-AC	NZL BODY W/AIR CHEM	78.95	QJS-B2-20MM-CM	QJS NOZZLE BODY	45.20
QJB363C-1/2-AC	NZL BODY W/AIR CHEM	78.95	QJS-B2-20MM-EA	QJS NOZZLE BODY	362.93
QJB363C-1/2X7MM-AC	NZL BODY W/AIR CHEM	78.95	QJS-B2-20MM-EE	QJS NOZZLE BODY	585.05
QJB363C-25MM-AC	NZL BODY W/AIR CHEM	78.95	QJS-B2-20MM-EM	QJS NOZZLE BODY	323.27
QJB363C-3/4-AC	NZL BODY W/AIR CHEM	78.95	QJS-B2-20MM-MM	QJS NOZZLE BODY	54.22
QJB363E-20MM-AC	NZL BODY W/AIR CHEM	78.95	QJS-B2-20MM-XX	QJS NOZZLE BODY	33.47
QJB364C-1-AC	NZL BODY W/AIR CHEM	78.95	QJS-B2-25MM-AA	QJS-B2-25MM-AA STACKABLE QCK TJT BOTTOM MOUNT NB	146.26
QJB364C-1/2-AC	NZL BODY W/AIR CHEM	78.95	QJS-B2-25MM-EE	QJS NOZZLE BODY	585.05
QJB364C-1/2X7MM-AC	NZL BODY W/AIR CHEM	78.95	QJS-B2-25MM-EM	QJS NOZZLE BODY	323.27
QJB364C-25MM-AC	NZL BODY W/AIR CHEM	78.95	QJS-B2-25MM-MX	QJS NOZZLE BODY	42.97
QJB364C-3/4-AC	NZL BODY W/AIR CHEM	78.95	QJS-B2-25MM-XM	QJS NOZZLE BODY	43.84
QJB364E-20MM-AC	NZL BODY W/AIR CHEM	78.95	QJS-B2-25MM-XX	QJS NOZZLE BODY	34.75
QJB365C-1-AC	NZL BODY W/AIR CHEM	78.95	QJS-B2-3/4-AA	QJS NOZZLE BODY	146.26
QJB365C-1/2-AC	NZL BODY W/AIR CHEM	78.95	QJS-B2-3/4-CE	QJS NOZZLE BODY	314.21
QJB365C-1/2X7MM-AC	NZL BODY W/AIR CHEM	78.95	QJS-B2-3/4-CM	QJS NOZZLE BODY	45.20
QJB365C-25MM-AC	NZL BODY W/AIR CHEM	78.95	QJS-B2-3/4-EA	QJS NOZZLE BODY	366.57
QJB365C-3/4-AC	NZL BODY W/AIR CHEM	78.95	QJS-B2-3/4-EE	QJS NOZZLE BODY	585.05
QJB365E-20MM-AC	NZL BODY W/AIR CHEM	78.95	QJS-B2-3/4-EM	QJS NOZZLE BODY	323.27
QJB4676-1/4-NYR	QJ4676 1/8 BSPT CAP & WASHER, NY&EPR	5.90	QJS-B2-3/4-MM	QJS NOZZLE BODY	54.22
QJB8355-1/4-NYB	1/4 DIAP. QUICK TJET NYB BSPT	15.11	QJS-B2-3/4-XM	QJS NOZZLE BODY	43.86
QJB8355-1/4-NYB-VI	1/4 DIAP. QUICK TJET NYB VITON BSPT	16.58	QJS-B2-3/4-XX	QJS NOZZLE BODY	33.47
QJB8355-1/8-NYB	1/8 DIAP. QUICK TJET NYB BSPT	15.11	QJS-B2-500-2-EA	QJS NOZZLE BODY	379.18
QJB8355-1/8-NYB-VI	1/8 DIAP. QUICK TJET NYB VITON BSPT	16.58	QJS-B2-500-2-EE	QJS NOZZLE BODY	604.83
QJB8360-AC	8360 W/AIR CHEM	60.24	QJS-B2-500-2-EM	QJS NOZZLE BODY	333.16
QJB8360-NYB	DIAPH. QUICK TEEJET	7.53	QJS-B2-500-L-EE	QJS NOZZLE BODY	604.83
QJHS-406-NYB	QUICK HOSE SHANK ASB	13.09	QJS-B2-500-L-EM	QJS NOZZLE BODY	333.16
QJHS-500-NYB	QUICK HOSE SHANK ASB	13.09	QJS-B2-500-R-EC	QJS NOZZLE BODY	324.14
QJP19011-MC	DIAPH. QUICK TEEJET W/MC	18.69	QJS-B2-500-R-EE	QJS NOZZLE BODY	604.83
QJP19011-NYB	DIAPH.QUICK TEEJET	9.94	QJS-B2-500-R-EM	QJS NOZZLE BODY	333.16
QJP3/8T-NYB	QUICKJT.BODY BSPP.NY	5.28	QJS-B2-750-2-EE	QJS NOZZLE BODY	604.83
QJS-B1-1-A	QJS NOZZLE BODY	75.48	QJS-B2-750-2-EM	QJS NOZZLE BODY	348.50
QJS-B1-1-E	QJS NOZZLE BODY	295.84	QJS-B2-750-2-XX	QJS NOZZLE BODY	46.06
QJS-B1-1-M	QJS NOZZLE BODY	29.49	QJS-B2-750-L-CC	QJS NOZZLE BODY	48.28
QJS-B1-1-X	QJS NOZZLE BODY	18.92	QJS-B2-750-L-EE	QJS NOZZLE BODY	602.84
QJS-B1-20MM-E	QJS NOZZLE BODY	295.85	QJS-B2-750-L-EM	QJS NOZZLE BODY	348.50
QJS-B1-20MM-X	QJS NOZZLE BODY	19.14	QJS-B2-750-R-EE	QJS NOZZLE BODY	602.84
QJS-B1-25MM-C	QJS NOZZLE BODY	20.47	QJS-B2-750-R-EM	QJS NOZZLE BODY	348.50
QJS-B1-3/4-A	QJS NOZZLE BODY	75.48	QJS-B2-750-R-XX	QJS NOZZLE BODY	46.06
QJS-B1-3/4-E	QJS NOZZLE BODY	295.84	QJS-B3-1-AAA	QJS NOZZLE BODY	217.43
			QJS-B3-1-CCC	QJS NOZZLE BODY	52.34

PART NO.	DESCRIPTION	U.S.DOLLARS	PART NO.	DESCRIPTION	U.S.DOLLARS
QJS-B3-1-CMM	QJS NOZZLE BODY	69.67	QJS-F2-1-XM	QJS NOZZLE BODY W/ FLOW METER	199.41
QJS-B3-1-EMM	QJS NOZZLE BODY	353.85	QJS-H0-25MM	QJS NOZZLE BODY	66.84
QJS-B3-1-MEE	QJS NOZZLE BODY	617.46	QJS-H2-25MM-CM	QJS-NOZZLE BODY	65.21
QJS-B3-1-MMM	QJS NOZZLE BODY	79.38	QJS-H4R-25MM-AAAA	QJS-H4R- STACKABLE BODY	309.49
QJS-B3-1-MMX	QJS BOTTOM MOUNT NOZZLE BODY	69.05	QJS-N0-1	QJS NOZZLE BODY	35.93
QJS-B3-1/2-CCC	QJS BOTTOM MOUNT NOZZLE BODY	52.60	QJS-N1-1-X	QJS NOZZLE BODY	25.89
QJS-B3-1000-R-EAM	QJS NOZZLE BODY	399.14	QJS-N1-1/2-E	QJS NOZZLE BODY	302.64
QJS-B3-20MM-EAA	QJS NOZZLE BODY	444.49	QJS-N1-20MM-C	QJS NOZZLE BODY	27.23
QJS-B3-20MM-EEE	QJS NOZZLE BODY	886.46	QJS-N1-25MM-C	QJS NOZZLE BODY	27.23
QJS-B3-3/4-AAA	QJS BOTTOM MOUNT STACKABLE	217.43	QJS-N1-25MM-E	QJS NOZZLE BODY	302.64
QJS-B3-3/4-CCC	QJS NOZZLE BODY	52.34	QJS-N1-3/4-E	QJS NOZZLE BODY	302.64
QJS-B3-3/4-MAA	NOZZLE	184.01	QJS-N1-3/4-X	QJS NOZZLE BODY	25.89
QJS-B3-3/4-MAE	NOZZLE	394.42	QJS-N2-1-ME	QJS NOZZLE BODY	327.84
QJS-B3-3/4-MCC	QJS BOTTOM MOUNT STACKABLE	60.15	QJS-N2-1/2-AA	QJS NOZZLE BODY	152.21
QJS-B3-500-2-EEE	QJS NOZZLE BODY	889.84	QJS-N2-3/4-XM	QJS NOZZLE BODY	51.10
QJS-B3-500-R-EEE	QJS NOZZLE BODY	887.89	QJS-N3-1-EMM	QJS NOZZLE BODY	353.85
QJS-B3-750-L-MMM	QJS BOTTOM MOUNT STACKABLE	90.01	QJS-N3-1/2-AAA	QJS NOZZLE BODY	223.27
QJS-B3-750-R-MMM	QJS BOTTOM MOUNT STACKABLE	90.01	QJS-N3-20MM-XXM	QJS NOZZLE BODY	66.73
QJS-B4-1-AAAA	QJS NOZZLE BODY	289.43	QJS-N3-3/4-AAA	QJS NOZZLE BODY	223.27
QJS-B4-1-CCMM	QJS NOZZLE BODY	86.48	QJS-N3-3/4-EAA	QJS NOZZLE BODY	445.82
QJS-B4-1-EMEM	QJS NOZZLE BODY	638.11	QJS-N3-3/4-EEE	QJS NOZZLE BODY	886.54
QJS-B4-1-EMMM	QJS NOZZLE BODY	371.75	QJS-N4L-1/2-AAAA	QJS NOZZLE BODY	296.71
QJS-B4-1-MMMM	QJS NOZZLE BODY	105.40	QJS-N4L-1/2-EEEE	QJS NOZZLE BODY	1178.08
QJS-B4-1-XXXX	QJS NOZZLE BODY	63.93	QJS-N4L-20MM-AAAA	QJS-N4L- STACKABLE BODY	296.71
QJS-B4-1/2-EEEE	QJS NOZZLE BODY	1136.70	QJS-N4L-20MM-XXXX	QJS NOZZLE BODY	71.19
QJS-B4-20MM-AAAA	QJS NOZZLE BODY	273.92	QJS-N4L-28MM-AAAA	QJS NOZZLE BODY	296.71
QJS-B4-25MM-AAAA	QJS NOZZLE BODY	289.43	QJS-N4L-3/4-AAAA	QJS NOZZLE BODY	296.71
QJS-B4-28MM-AAAA	QJS NOZZLE BODY	289.43	QJS-N4L-3/4-EEEE	QJS NOZZLE BODY	1178.08
QJS-B4-28MM-AAXX	QJS NOZZLE BODY	176.69	QJS-N4R-1/2-AAAA	QJS NOZZLE BODY	296.71
QJS-B4-3/4-AAAA	QJS NOZZLE BODY	289.43	QJS-N4R-20MM-AAAA	QJS NOZZLE BODY	296.71
QJS-B4-3/4-MCCC	QJS BOTTOM MOUNT STACKABLE	76.80	QJS-N4R-20MM-XXXX	QJS NOZZLE BODY	71.19
QJS-BL2-1-XM	QJS NOZZLE BODY W/RIGHT DCV	48.24	QJS-N4R-28MM-AAAA	QJS NOZZLE BODY	296.71
QJS-BR1-1-M	QJS NOZZLE BODY W/ RIGHT DCV	33.87	QJS-N4R-3/4-AAAA	QJS NOZZLE BODY	296.71
QJS-BR2-1-MM	QJS NOZZLE BODY W/ RIGHT DCV	58.60	QJS-N4R-3/4-EEEE	QJS NOZZLE BODY	1178.08
QJS-BR2-1-XM	QJS NOZZLE BODY W/RIGHT DCV	48.24	QJS-P-1	1: WET BOOM BLANK	6.35
QJS-D-1-AX-5-P	QJS-D NOZZLE BODY	106.51	QJS-S0-1	QJS NOZZLE BODY	15.44
QJS-D-1-CM-3-P	QJS-D NOZZLE BODY	61.87	QJS-S0-25MM	QJS NOZZLE BODY	6.44
QJS-D-1-CM-5-P	QJS-D NOZZLE BODY	61.87	QJS-S1-1-E	QJS NOZZLE BODY	297.50
QJS-D-1-CX-3-P	QJS-D NOZZLE BODY	55.47	QJS-S1-1-M	QJS NOZZLE BODY	31.15
QJS-D-1-CX-5-P	QJS-D NOZZLE BODY	55.47	QJS-S1-1-V	QJS NOZZLE BODY	297.49
QJS-D-1-MM-3-P	QJS-D NOZZLE BODY	66.93	QJS-S1-1-X	QJS NOZZLE BODY	20.79
QJS-D-1-MX-3-P	QJS-D NOZZLE BODY	60.52	QJS-S1-1/2-E	QJS NOZZLE BODY	297.50
QJS-D-1-XM-3-P	QJS-D NOZZLE BODY	60.52	QJS-S1-1/2-M	QJS NOZZLE BODY	31.15
QJS-D-1-XM-5-P	QJS-D NOZZLE BODY	60.52	QJS-S1-20MM-E	QJS NOZZLE BODY	297.50
QJS-D-1-XM-P-3	QJS-D NOZZLE BODY	60.52	QJS-S1-20MM-M	QJS NOZZLE BODY	31.15
QJS-D-1-XX-3-P	QJS-D NOZZLE BODY	51.78	QJS-S1-20MM-V	QJS NOZZLE BODY	297.49
QJS-D-25MM-EM-3-P	QJS-D NOZZLE BODY	328.07	QJS-S1-20MM-X	QJS NOZZLE BODY	20.79
QJS-D-25MM-XM-3-P	QJS NOZZLE BODY W/RIGHT DCV	60.52	QJS-S1-25MM-C	QJS NOZZLE BODY	22.12
QJS-D-28MM-EM-3-P	QJS-D NOZZLE BODY	328.07	QJS-S1-25MM-E	QJS NOZZLE BODY	297.50
QJS-D-3/4-CX-3-P	QJS-D NOZZLE BODY	55.47	QJS-S1-3/4-X	QJS NOZZLE BODY	20.79
QJS-D-3/4-MM-5-P	QJS-D NOZZLE BODY	66.93	QJS-S1-500-2-E	QJS NOZZLE BODY	305.50
QJS-F1-1-A	QJS NOZZLE BODY W/ FLOW METER	230.55	QJS-S1-500-L-E	QJS NOZZLE BODY	305.50
QJS-F1-1-C	QJS NOZZLE BODY W/ FLOW METER	172.82	QJS-S1-500-R-E	QJS NOZZLE BODY	305.50
QJS-F1-1/2-M	QJS NOZZLE BODY W/ FLOW METER	184.54	QJS-S1-500-R-M	QJS NOZZLE BODY	43.76
QJS-F1-3/4-C	QJS NOZZLE BODY W/ FLOW METER	172.82	QJS-S1-750-L-X	QJS NOZZLE BODY	31.37
QJS-F2-1-EM	QJS NOZZLE BODY W/ FLOW METER	471.37	QJS-S1-750-R-X	QJS NOZZLE BODY	31.37
			QJS-S2-1-AA	QJS NOZZLE BODY	148.38
			QJS-S2-1-CM	QJS NOZZLE BODY	47.32
			QJS-S2-1-EM	QJS NOZZLE BODY	325.39
			QJS-S2-1-MC	QJS NOZZLE BODY	56.35
			QJS-S2-1-MM	QJS NOZZLE BODY	56.35
			QJS-S2-1-XM	QJS NOZZLE BODY	45.97
			QJS-S2-1/2-EE	QJS NOZZLE BODY	592.28

PART NO.	DESCRIPTION	U.S.DOLLARS	PART NO.	DESCRIPTION	U.S.DOLLARS
QJS-S2-1/2-EM	QJS NOZZLE BODY	325.39	SJ3-15-VP	TJ STRMJT / LT GREEN	13.37
QJS-S2-20MM-AA	QJS NOZZLE BODY	148.38	SJ3-20-VP	TEEJET STRMJT/BLACK	13.37
QJS-S2-20MM-CM	QJS NOZZLE BODY	47.32	SJ3-VR-X0.5	VARIABLE RATE 3 OUTLET STRMJT/YELLOW X0.5	34.03
QJS-S2-20MM-EE	QJS NOZZLE BODY	592.28	SJ3-VR-X1.0	VARIABLE RATE 3 OUTLET STRMJT/RED X1.0	34.03
QJS-S2-20MM-EM	QJS NOZZLE BODY	325.39	SJ3-VR-X2.0	VARIABLE RATE 3 OUTLET STRMJT/LIGHT BLUE X2.0	34.03
QJS-S2-20MM-MM	QJS NOZZLE BODY	56.35	SJ7A-015-VP	7 HOLE STRMJT/GREEN	16.98
QJS-S2-20MM-MX	QJS NOZZLE BODY	45.97	SJ7A-02-VP	7 HOLE STRMJT/YELLOW	16.98
QJS-S2-25MM-CM	QJS-NOZZLE BODY	47.30	SJ7A-03-VP	7 HOLE STRMJT/BLUE	16.98
QJS-S2-25MM-EE	QJS NOZZLE BODY	592.28	SJ7A-04-VP	7 HOLE STRMJT/RED	16.98
QJS-S2-3/4-AA	QJS NOZZLE BODY	148.38	SJ7A-05-VP	7 HOLE STRMJT/BROWN	16.98
QJS-S2-3/4-CC	QJS NOZZLE BODY	38.28	SJ7A-06-VP	7 HOLE STRMJT/GRAY	16.98
QJS-S2-3/4-CM	QJS NOZZLE BODY	47.32	SJ7A-08-VP	7 HOLE STRMJT/WHITE	16.98
QJS-S2-3/4-EM	QJS NOZZLE BODY	325.39	SJ7A-10-VP	7 HOLE STRMJT/LT BLUE	16.98
QJS-S2-3/4-MM	QJS NOZZLE BODY	56.35	SJ7A-15-VP	7 HOLE STRMJT/LT GREEN	16.98
QJS-S2-3/4-XX	QJS NOZZLE BODY	35.60	SJ7A-VR-X0.5	VARIABLE RATE 7 OUTLET STRMJT/YELLOW X0.5	37.65
QJS-S2-500-2-EM	QJS NOZZLE BODY	327.95	SJ7A-VR-X1.0	VARIABLE RATE 7 OUTLET STRMJT/RED X1.0	37.65
QJS-S2-500-2-ME	QJS NOZZLE BODY	322.71	SJ7A-VR-X2.0	VARIABLE RATE 7 OUTLET STRMJT/LIGHT BLUE X2.0	37.65
QJS-S2-500-2-XX	QJS NOZZLE BODY	46.19	T-10W	CONEJET TIP,BRASS	10.95
QJS-S2-500-L-CC	QJS NOZZLE BODY	50.37	T-12W	CONEJET TIP,BRASS	10.95
QJS-S2-500-L-CE	QJS NOZZLE BODY	323.03	T-2W	CONEJET TIP,BRASS	10.95
QJS-S2-500-L-CM	QJS NOZZLE BODY	57.90	T-3W	CONEJET TIP,BRASS	10.95
QJS-S2-500-L-EE	QJS NOZZLE BODY	599.63	T-4W	CONEJET TIP,BRASS	10.95
QJS-S2-500-L-EM	QJS NOZZLE BODY	327.95	T-5W	CONEJET TIP,BRASS	10.95
QJS-S2-500-L-XX	QJS NOZZLE BODY	46.19	T-6W	CONEJET TIP,BRASS	10.95
QJS-S2-500-R-CE	QJS NOZZLE BODY	323.03	T-8W	CONEJET TIP,BRASS	10.95
QJS-S2-500-R-EC	QJS NOZZLE BODY	326.27	T-SS10W	HOLLOW CONE TIP SS	29.59
QJS-S2-500-R-EE	QJS NOZZLE BODY	599.63	T-SS12W	HOLLOW CONE TIP SS	29.59
QJS-S2-500-R-EM	QJS NOZZLE BODY	327.95	T-SS2W	HOLLOW CONE TIP SS	29.59
QJS-S2-500-R-XX	QJS NOZZLE BODY	46.19	T-SS3W	HOLLOW CONE TIP SS	29.59
QJS-S2-750-2-EE	QJS NOZZLE BODY	606.98	T-SS4W	HOLLOW CONE TIP SS	29.59
QJS-S2-750-2-EM	STACKABLE QCK TEEJET SIDE MOUNT NZL	322.70	T-SS5W	HOLLOW CONE TIP SS	29.59
QJS-S2-750-L-CC	QJS NOZZLE BODY	50.89	T-SS6W	HOLLOW CONE TIP SS	29.59
QJS-S2-750-L-EE	QJS NOZZLE BODY	599.63	T-SS8W	HOLLOW CONE TIP SS	29.59
QJS-S2-750-L-EM	STACKABLE QCK TEEJET SIDE MOUNT NZL	322.70	TF-VP10	TURBO FLOODJT,POLYMR	4.51
QJS-S2-750-L-XX	QJS NOZZLE BODY	46.19	TF-VP2	TURBO FLOODJT, POLYMR	4.51
QJS-S2-750-R-EE	QJS NOZZLE BODY	599.63	TF-VP2.5	TURBO FLOODJT, POLYMR	4.51
QJS-S2-750-R-EM	STACKABLE QCK TEEJET SIDE MOUNT NZL	322.70	TF-VP3	TURBO FLOODJT, POLYMR	4.51
QJS-S2-750-R-XX	QJS NOZZLE BODY	46.19	TF-VP4	TURBO FLOODJT,POLYMR	4.51
QJS-X1-25MM-C	QJS NOZZLE BODY W/ FLOW METER, SS INLET	185.57	TF-VP5	TURBO FLOODJT, POLYMR	4.51
QJT-NYB	QUICKJET BODY,ASB.NY	7.67	TF-VP7.5	TURBO FLOODJT, POLYMR	4.51
QJT38622-NYB	DIAPH.QK,TJ,YELLOW	8.20	TF-VS10	TURBO FLOODJT,SS&CE	19.72
QJT8360-1/4F-NYB	DIAPH. QUICK TEEJET 1/4F	8.20	TF-VS2	TURBO FLOODJT,SS&CE	19.72
QJT8360-1/4F-NYB-VI	DIAPH. QUICK TEEJET 1/4F	9.00	TF-VS2.5	TURBO FLOODJT,SS&CE	19.72
QJT8360-NYB	DIAPH.QUICK TEEJET	8.20	TF-VS3	TURBO FLOODJT,SS&CE	19.72
QJT8360-NYB-VI	DIAPH.QUICK TEEJET	9.00	TF-VS4	TURBO FLOODJT,SS&CE	19.72
S98450-1/4M	DBLE ROLLOVER VALVE W/CHK NPS	61.39	TF-VS5	TURBO FLOODJT,SS&CE	19.72
S98450-3-1/4M	SPEC DBLE ROLLOVER VALVE W/CHK	65.78	TF-VS7.5	TURBO FLOODJT,SS&CE	19.72
S98450-3-3/8M	SPEC DBLE ROLLOVER VALVE W/CHK	65.78	TFW-12	FLOODJET TIP,BRASS	15.06
S98451-1/4M	SINGLE ROLLOVER VALVE W/CHK NPS	56.98	TFW-20	FLOODJET TIP,BRASS	15.06
SJ3-015-VP	TEEJET STRMJT/GREEN	13.37	TG-0.3	FULL CONE TIP,BRASS	23.57
SJ3-02-VP	TEEJET STRMJT/YELLOW	13.37	TG-0.4	FULL CONE TIP,BRASS	23.57
SJ3-03-VP	TEEJET STRMJT/BLUE	13.37	TG-0.5	FULL CONE TIP,BRASS	23.57
SJ3-04-VP	TEEJET STREAMJET/RED	13.37	TG-0.6	FULL CONE TIP,BRASS	23.57
SJ3-05-VP	TEEJET STRMJT/BROWN	13.37	TG-0.7	FULL CONE TIP,BRASS	23.57
SJ3-06-VP	TEEJET STRMJT/GRAY	13.37	TG-0.8	FULL CONE TIP,BRASS	23.57
SJ3-08-VP	TEEJET STRMJT/WHITE	13.37	TG-0.9	FULL CONE TIP,BRASS	23.57
SJ3-10-VP	TEEJET STRMJT/LTBLUE	13.37	TG-1	FULL CONE TIP,BRASS	13.58
			TG-1.5	FULL CONE TIP,BRASS	13.58
			TG-10	FULL CONE TIP,BRASS	13.58

PART NO.	DESCRIPTION	U.S.DOLLARS	PART NO.	DESCRIPTION	U.S.DOLLARS
TG-2	FULL CONE TIP,BRASS	13.58	TJ60-8008VS	VISIFLO TWINJET SS	18.15
TG-2.5	FULLCONE TIP BRASS	13.58	TJ60-8010VS	VISIFLO TWINJET SS	18.15
TG-3	FULL CONE TIP,BRASS	13.58	TK-.50	FLOODJET TIP,BRASS	10.27
TG-3.5	FULL CONE TIP,BRASS	13.58	TK-.75	FLOODJET TIP,BRASS	10.27
TG-4	FULL CONE TIP,BRASS	13.58	TK-1	FLOODJET TIP,BRASS	10.27
TG-4.3	FULLCONE TIP BRASS	13.58	TK-1.5	FLOODJET TIP,BRASS	10.27
TG-5	FULL CONE TIP,BRASS	13.58	TK-10	FLOODJET TIP,BRASS	10.27
TG-6	FULL CONE TIP,BRASS	13.58	TK-12	FLOODJET TIP BRASS	10.27
TG-6.5	FULL CONE TIP,BRASS	13.58	TK-15	FLOODJET TIP,BRASS	10.27
TG-8	FULL CONE TIP BRASS	13.58	TK-18	FLOODJET TIP,BRASS	10.27
TG-SS0.3	FULL CONE TIP,ST.STL	63.90	TK-2	FLOODJET TIP,BRASS	10.27
TG-SS0.4	FULL CONE TIP,ST.STL	63.90	TK-2.5	FLOODJET TIP,BRASS	10.27
TG-SS0.5	FULL CONE TIP,ST.STL	63.90	TK-20	FLOODJET TIP,BRASS	10.27
TG-SS0.6	FULL CONE TIP,ST.STL	63.90	TK-3	FLOODJET TIP,BRASS	10.27
TG-SS0.7	FULL CONE TIP,ST.STL	63.90	TK-30	FLOODJET TIP,BRASS	10.27
TG-SS0.8	FULL CONE TIP,ST.STL	63.90	TK-4	FLOODJET TIP,BRASS	10.27
TG-SS0.9	FULL CONE TIP,ST.STL	63.90	TK-40	FLOODJET TIP,BRASS	10.27
TG-SS1	FULL CONE TIP,ST.STL	29.92	TK-5	FLOODJET TIP,BRASS	10.27
TG-SS1.5	FULL CONE TIP,ST.STL	29.92	TK-7.5	FLOODJET TIP,BRASS	10.27
TG-SS10	FULL CONE TIP,ST.STL	29.92	TK-SS.50	FLOODJET TIP,ST.STL.	18.68
TG-SS10W	FULL CONE TIP,ST.STL	39.10	TK-SS.75	FLOODJET TIP,ST.STL.	18.68
TG-SS12W	FULL CONE TIP,ST.STL	39.10	TK-SS1	FLOODJET TIP,ST.STL.	18.68
TG-SS14W	FULL CONE TIP,ST.STL	39.10	TK-SS1.5	FLOODJET TIP,ST.STL.	18.68
TG-SS2	FULL CONE TIP,ST.STL	29.92	TK-SS10	FLOODJET TIP,ST.STL.	18.68
TG-SS2.5	FULL CONE TIP,ST.STL	29.92	TK-SS12	FLOODJET TIP ST.STL	18.68
TG-SS2.8W	FULLCONE TIP,ST.STL.	39.10	TK-SS15	FLOODJET TIP,ST.STL.	18.68
TG-SS3	FULL CONE TIP,ST.STL	29.92	TK-SS18	FLOODJET TIP,ST.STL.	18.68
TG-SS3.5	FULL CONE TIP,ST.STL	29.92	TK-SS2	FLOODJET TIP,ST.STL.	18.68
TG-SS4	FULL CONE TIP ST.STL	29.92	TK-SS2.5	FLOODJET TIP,ST.STL.	18.68
TG-SS4.3W	FULLCONE TIP,ST.STL.	39.10	TK-SS20	FLOODJET TIP,ST.STL.	18.68
TG-SS5	FULL CONE TIP,ST.STL	29.92	TK-SS20L	FLOODJET TIP,ST.STL.	35.21
TG-SS5.6W	FULLCONE TIP,ST.STL.	39.10	TK-SS24	FLOODJET TIP,ST.STL.	18.68
TG-SS6	FULL CONE TIP,ST.STL	29.92	TK-SS3	FLOODJET TIP,ST.STL.	18.68
TG-SS6.5	FULL CONE TIP,ST.STL	29.92	TK-SS30	FLOODJET TIP,ST.STL.	18.68
TG-SS8	FULL CONE TIP,ST.STL	29.92	TK-SS30L	FLOODJET TIP,ST.STL.	35.21
TG-SS8W	FULLCONE TIP,ST.STL.	39.10	TK-SS4	FLOODJET TIP,ST.STL.	18.68
TJ60-11002VS	VISIFLO TWINJET SS	18.15	TK-SS40	FLOODJET TIP,ST.STL.	18.68
TJ60-11003VS	VISIFLO TWINJET SS	18.15	TK-SS40L	FLOODJET TIP,ST.STL.	35.21
TJ60-11004VS	VISIFLO TWINJET SS	18.15	TK-SS5	FLOODJET TIP,ST.STL.	18.68
TJ60-11005VS	VISIFLO TWINJET VS	18.15	TK-SS50	FLOODJET TIP ST.STL.	18.68
TJ60-11006VS	VISIFLO TWINJET SS	18.15	TK-SS50L	FLOODJET TIP,ST.STL.	35.21
TJ60-11008VS	VISIFLO TWINJET SS	18.15	TK-SS60L	FLOODJET TIP,ST.STL.	35.21
TJ60-11010VS	VISIFLO TWINJET SS	18.15	TK-SS7.5	FLOODJET TIP,ST.STL.	18.68
TJ60-4002EVS	VISIFLO TWINJET SS	25.29	TK-SS70L	FLOODJET TIP,ST.STL.	35.21
TJ60-4002VS	VISIFLO TWINJET SS	18.15	TK-SS80L	FLOODJET TIP,ST.STL.	35.21
TJ60-4003EVS	VISIFLO TWINJET SS	25.29	TK-VP1	VISIFLO FLOODJET CE	1.51
TJ60-4004EVS	VISIFLO TWINJET SS	25.29	TK-VP1.5	VISIFLO FLOODJET CE	1.51
TJ60-650134VS	VISIFLO TWINJET SS	18.15	TK-VP10	VISIFLO FLOODJET CE	1.51
TJ60-6501VS	VISIFLO TWINJET SS	18.15	TK-VP2	VISIFLO FLOODJET CE	1.51
TJ60-6502VS	VISIFLO TWINJET SS	18.15	TK-VP2.5	VISIFLO FLOODJET CE	1.51
TJ60-6503VS	VISIFLO TWINJET SS	18.15	TK-VP3	VISIFLO FLOODJET CE	1.51
TJ60-6504VS	VISIFLO TWINJET SS	18.15	TK-VP4	VISIFLO FLOODJET CE	1.51
TJ60-6506VS	VISIFLO TWINJET SS	18.15	TK-VP5	VISIFLO FLOODJET CE	1.51
TJ60-6508VS	VISIFLO TWINJET SS	18.15	TK-VP7.5	VISIFLO FLOODJET CE	1.51
TJ60-8001VS	VISIFLO TWINJET SS	18.15	TK-VS10	VISIFLO FLOD.JT.SS&CE	17.79
TJ60-8002EVS	VISIFLO TWINJET SS	25.29	TK-VS2	VISIFLO FLOD.JT.SS&CE	17.79
TJ60-8002VS	VISIFLO TWINJET SS	18.15	TK-VS2.5	VISIFLO FLOD.JT.SS&CE	17.79
TJ60-8003EVS	VISIFLO TWINJET SS	25.29	TK-VS3	VISIFLO FLOD.JT.SS&CE	17.79
TJ60-8003VS	VISIFLO TWINJET SS	18.15	TK-VS4	VISIFLO FLOD.JT.SS&CE	17.79
TJ60-8004EVS	VISIFLO TWINJET SS	25.29	TK-VS5	VISIFLO FLOD.JT.SS&CE	17.79
TJ60-8004VS	VISIFLO TWINJET SS	18.15	TK-VS7.5	VISIFLO FLOD.JT.SS&CE	17.79
TJ60-8005VS	VISIFLO TWINJET VS	18.15	TKT-VP3	FLOODJET	3.82
TJ60-8006EVS	VISIFLO TWINJET SS	25.29	TKT-VP5	FLOODJET	3.82
TJ60-8006VS	VISIFLO TWINJET SS	18.15	TLX-12	CONEJET TIP,BRASS	14.35



PART NO.	DESCRIPTION	U.S.DOLLARS	PART NO.	DESCRIPTION	U.S.DOLLARS
TLX-14	CONEJET TIP,BRASS	14.35	TP0010-HSS	TEEJET TIP,HARD.SS	22.10
TLX-18	CONEJET TIP,BRASS	14.35	TP0010-SS	TEEJET TIP,ST.STL.	16.06
TLX-2.5	CONEJET TIP,BRASS	14.35	TP0011-SS	TEEJET TIP STL.STEEL	16.06
TLX-8	CONEJET TIP,BRASS	14.35	TP0012-SS	TEEJET TIP,ST.STL.	16.06
TLX-SS12	CONEJET TIP S.S.	43.34	TP0015	TEEJET TIP,BRASS	6.29
TLX-SS18	CONEJET TIP S.S.	43.34	TP0015-HSS	TEEJET TIP,HARD.SS	22.10
TLY-1.25	CONEJET TIP,BRASS	14.35	TP0015-SS	TEEJET TIP,ST.STL.	16.06
TLY-1.5	CONEJET TIP,BRASS	14.35	TP0020	TEEJET TIP,BRASS	6.29
TLY-10	CONEJET TIP,BRASS	14.35	TP0020-HSS	TEEJET TIP,HARD.SS	22.10
TLY-12	CONEJET TIP,BRASS	14.35	TP0020-SS	TEEJET TIP,ST.STL.	16.06
TLY-18	CONEJET TIP,BRASS	14.35	TP0030	TEEJET TIP, BRASS	6.29
TLY-2	CONEJET TIP,BRASS	14.35	TP0030-SS	TEEJET TIP,ST.STL.	16.06
TLY-26	CONEJET TIP,BRASS	14.35	TP0040	TEEJET TIP,BRASS	6.29
TLY-3	CONEJET TIP,BRASS	14.35	TP0040-SS	TEEJET TIP,ST.STL.	16.06
TLY-4	CONEJET TIP,BRASS	14.35	TP1100050-SS	TEEJET TIP ST.STL.	35.88
TLY-5	CONEJET TIP BRASS	14.35	TP1100067	TEEJET TIP,BRASS	6.29
TLY-6	CONEJET TIP,BRASS	14.35	TP1100067-SS	TEEJET TIP,303ST.STL	35.88
TLY-8	CONEJET TIP,BRASS	14.35	TP11001	TEEJET TIP,BRASS	6.29
TLY-SS1	CONEJET TIP ST.STL.	43.34	TP11001-HSS	TEEJET TIP,HARD.SS	22.10
TLY-SS10	CONEJET TIP,ST.STL.	43.34	TP11001-SS	TEEJET TIP,ST.STL.	16.06
TLY-SS12	CONEJET TIP,ST.STL.	43.34	TP110015	TEEJET TIP,BRASS	6.29
TLY-SS2	CONEJET TIP S.S.	43.34	TP110015-HSS	TEEJET TIP,HARD.SS	22.10
TP000021-SS	TEEJET TIP,ST.STL.	16.35	TP110015-SS	TEEJET TIP,ST.STL.	16.06
TP000050	TEEJET TIP,BRASS	6.39	TP110015LP	TEEJET TIP LOW PRES.	9.34
TP000050-HSS	TEEJET TIP,HARD.SS	22.47	TP110015LP-SS	TEEJET TIP LOW PRES.	22.91
TP000050-SS	TEEJET TIP,ST.STL.	16.35	TP110015VK	TEEJET TIP CERAMIC	10.70
TP000067	TEEJET TIP,BRASS	6.39	TP110015VP	TEEJET TIP POLYMER	1.38
TP000067-HSS	TEEJET TIP,HARD.SS	22.47	TP110015VS	VISIFLO TEEJET TIP	9.34
TP000067-SS	TEEJET TIP,ST.STL.	16.35	TP11001LP-SS	TEEJET TIP LOW PRES.	22.91
TP0001	TEEJET TIP,BRASS	6.29	TP11001VK	TEEJET TIP CERAMIC	10.70
TP0001-HSS	TEEJET TIP,HARD.SS	22.10	TP11001VS	VISIFLO TEEJET TIP	9.34
TP0001-SS	TEEJET TIP,ST.STL.	16.06	TP11002	TEEJET TIP,BRASS	6.29
TP00015	TEEJET TIP,BRASS	6.29	TP11002-HSS	TEEJET TIP,HARD.SS	22.10
TP00015-HSS	TEEJET TIP,HARD.SS	22.10	TP11002-SS	TEEJET TIP,ST.STL.	16.06
TP00015-SS	TEEJET TIP,ST.STL.	16.06	TP11002-VS	VISIFLO TEEJET TIP	9.34
TP0002	TEEJET TIP,BRASS	6.29	TP11002LP-SS	TEEJET TIP LOW PRES.	22.91
TP0002-HSS	TEEJET TIP,HARD.SS	22.10	TP11002VP	TEEJET TIP POLYMER, YELLOW	1.38
TP0002-SS	TEEJET TIP,ST.STL.	16.06	TP11003	TEEJET TIP,BRASS	6.29
TP00025-HSS	TEEJET TIP,HARD.SS	22.10	TP11003-HSS	TEEJET TIP,HARD.SS	22.10
TP0003	TEEJET TIP,BRASS	6.29	TP11003-SS	TEEJET TIP,ST.STL.	16.06
TP0003-HSS	TEEJET TIP,HARD.SS	22.10	TP11003-VS	VISIFLO TEEJET TIP	9.34
TP0003-SS	TEEJET TIP,ST.STL.	16.06	TP11003LP	TEEJET TIP LOW PRES.	9.34
TP0004	TEEJET TIP,BRASS	6.29	TP11003LP-SS	TEEJET TIP LOW PRES.	22.91
TP0004-HSS	TEEJET TIP,HARD.SS	22.10	TP11003VP	TEEJET TIP POLYMER BLUE	1.38
TP0004-SS	TEEJET TIP,ST.STL.	16.06	TP11004	TEEJET TIP,BRASS	6.29
TP00045-SS	TEEJET TIP,ST.STL.	16.06	TP11004-HSS	TEEJET TIP,HARD.SS	22.10
TP0005	TEEJET TIP,BRASS	6.29	TP11004-SS	TEEJET TIP,ST.STL.	16.06
TP0005-HSS	TEEJET TIP,HARD.SS	22.10	TP11004-VS	VISIFLO TEEJET TIP	9.34
TP0005-SS	TEEJET TIP,ST.STL.	16.06	TP11004LP	TEEJET TIP LOW PRES.	9.34
TP00055	TEEJET TIP,BRASS	6.29	TP11004LP-SS	TEEJET TIP LOW PRES.	22.91
TP00055-SS	TEEJET TIP,ST.STL.	16.06	TP11004VP	TEEJET TIP POLYMER,RED	1.38
TP0005TE	TEEJET EXT.TIP,BRASS	16.06	TP11005	TEEJET TIP,BRASS	6.29
TP0006	TEEJET TIP,BRASS	6.29	TP11005-SS	TEEJET TIP,ST.STL.	16.06
TP0006-HSS	TEEJET TIP,HARD.SS	22.10	TP11005-VS	VISIFLO TEEJET TIP	9.34
TP0006-SS	TEEJET TIP,ST.STL.	16.06	TP11005LP	TEEJET TIP LOW PRES.	9.34
TP00065-SS	TEEJET TIP,ST.STL.	16.06	TP11005LP-SS	TEEJET TIP LOW PRES.	22.91
TP0007-SS	TEEJET TIP,ST.STL.	16.06	TP11005VP	TEEJET TIP POLYMER	1.38
TP0008	TEEJET TIP,BRASS	6.29	TP11006	TEEJET TIP,BRASS	6.29
TP0008-HSS	TEEJET TIP,HARD.SS	22.10	TP11006-HSS	TEEJET TIP,HARD.SS	22.10
TP0008-SS	TEEJET TIP,ST.STL.	16.06	TP11006-SS	TEEJET TIP,ST.STL.	16.06
TP0008TE	TEEJET EXT.TIP,BRASS	16.06	TP11006-VS	VISIFLO TEEJET TIP	9.34
TP0009	TEEJET TIP,BRASS	6.29	TP11006LP	TEEJET TIP LOW PRES.	9.34
TP0009-SS	TEEJET TIP,ST.STL.	16.06	TP11006LP-SS	TEEJET TIP LOW PRES.	22.91
TP0010	TEEJET TIP,BRASS	6.29	TP11006VP	TEEJET TIP POLYMER	1.38



# COMPREHENSIVE LIST

PART NO.	DESCRIPTION	U.S.DOLLARS	PART NO.	DESCRIPTION	U.S.DOLLARS
TP11007-SS	TEEJET TIP,ST.STL.	16.06	TP40035-SS	TEEJET TIP,ST.STL.	16.06
TP11008	TEEJET TIP,BRASS	6.29	TP4003E	TEEJET TIP BRASS	6.39
TP11008-SS	TEEJET TIP,ST.STL.	16.06	TP4003E-SS	TEEJET TIP ST.STL.	16.35
TP11008-VS	VISIFLO TEEJET TIP	9.34	TP4004-SS	TEEJET TIP,ST.STL.	16.06
TP11008E-SS	TEEJET TIP ST.STL.	16.35	TP40045-SS	TEEJET TIP,ST.STL.	16.06
TP11008LP	TEEJET TIP LOW PRES.	9.34	TP4004E	TEEJET TIP BRASS	6.39
TP11008LP-SS	TEEJET TIP LOW PRES.	22.91	TP4004E-SS	TEEJET TIP,ST.STL.	16.35
TP11008VP	TEEJET TIP POLYMER	1.38	TP4005-SS	TEEJET TIP,ST.STL.	16.06
TP11009-SS	TEEJET TIP,ST.STL.	16.06	TP40055-SS	TEEJET TIP,ST.STL.	16.06
TP11010	TEEJET TIP,BRASS	6.29	TP4005E-SS	TEEJET TIP,ST.STL.	16.35
TP11010-SS	TEEJET TIP,ST.STL.	16.06	TP4006-SS	TEEJET TIP,ST.STL.	16.06
TP11010E-SS	TEEJET TIP ST.STL.	16.35	TP40065-SS	TEEJET TIP,ST.STL.	16.06
TP11010LP	TEEJET TIP LOW PRES.	9.34	TP4006E	TEEJET TIP BRASS	6.39
TP11010LP-SS	TEEJET TIP LOW PRES.	22.91	TP4006E-SS	TEEJET TIP,ST.STL.	16.35
TP11012-SS	TEEJET TIP, SS	16.06	TP4007-SS	TEEJET TIP,ST.STEEL	16.06
TP11015	TEEJET TIP,BRASS	6.29	TP4008-SS	TEEJET TIP,ST.STL.	16.06
TP11015-SS	TEEJET TIP,ST.STL.	16.06	TP4010	TEEJET TIP,BRASS	6.29
TP11015E-SS	TEEJET TIP,ST.STL.	16.35	TP4010-SS	TEEJET TIP,ST.STL.	16.06
TP11015LP	TEEJET TIP LOW PRES.	9.34	TP4010E	TEEJET TIP,BRASS	6.39
TP11015LP-SS	TEEJET TIP LOW PRES.	22.91	TP4015	TEEJET TIP,BRASS	6.29
TP11020	TEEJET TIP,BRASS	6.29	TP4015-SS	TEEJET TIP,ST.STL.	16.06
TP11020-SS	TEEJET TIP,ST.STEEL	16.06	TP4020	TEEJET TIP,BRASS	6.29
TP11020LP	TEEJET TIP LOW PRES	9.34	TP4020-SS	TEEJET TIP,ST.STL.	16.06
TP11020LP-SS	TEEJET TIP LOW PRES.	22.91	TP40200L	TEEJET TIP,BRASS	28.92
TP11030	TEEJET TIP,BRASS	6.29	TP4025-SS	TEEJET TIP,ST.STEEL	16.06
TP11030-SS	TEEJET TIP ST.STL.	16.06	TP4030	TEEJET TIP,BRASS	6.29
TP11040	TEEJET TIP,BRASS	6.29	TP4030-SS	TEEJET TIP,ST.STL.	16.06
TP11050	TEEJET TIP,BRASS	6.29	TP4040	TEEJET TIP,BRASS	6.29
TP11060	TEEJET TIP,BRASS	6.29	TP4040-SS	TEEJET TIP,ST.STL.	16.06
TP1501-SS	TEEJET TIP,ST.STL.	16.06	TP4050	TEEJET TIP,BRASS	6.29
TP1502-SS	TEEJET TIP,ST.STL.	16.06	TP4050-SS	TEEJET TIP,ST.STL.	16.06
TP1503-SS	TEEJET TIP,ST.STL.	16.06	TP4060	TEEJET TIP,BRASS	6.29
TP1504-SS	TEEJET TIP,ST.STL.	16.06	TP4060-SS	TEEJET TIP,ST.STL.	16.06
TP1505-SS	TEEJET TIP,ST.STL.	16.06	TP500025-SS	TEEJET TIP,ST.STL.	35.88
TP1506-SS	TEEJET TIP,ST.STL.	16.06	TP5002-SS	TEEJET TIP,ST.STL.	16.06
TP1507-SS	TEEJET TIP,ST.STL.	16.06	TP5003-SS	TEEJET TIP,ST.STL.	16.06
TP1508-SS	TEEJET TIP,ST.STL.	16.06	TP5004-SS	TEEJET TIP,ST.STL.	16.06
TP1510-SS	TEEJET TIP,ST.STL.	16.06	TP5005-SS	TEEJET TIP,ST.STL.	16.06
TP1515	TEEJET TIP,BRASS	6.29	TP5006-SS	TEEJET TIP,ST.STL.	16.06
TP1520-SS	TEEJET TIP, SS	16.06	TP5008-SS	TEEJET TIP,ST.STL.	16.06
TP2501-SS	TEEJET TIP,ST.STL.	16.06	TP650017	TEEJET TIP,BRASS	13.06
TP25015-SS	TEEJET TIP,ST.STL.	16.06	TP650017-SS	TEEJET TIP,ST.STL.	35.88
TP2502-SS	TEEJET TIP,ST.STL.	16.06	TP650025	TEEJET TIP,BRASS	13.06
TP2503-SS	TEEJET TIP,ST.STL.	16.06	TP650025-SS	TEEJET TIP,ST.STL.	35.88
TP2504-SS	TEEJET TIP,ST.STL.	16.06	TP650033	TEEJET TIP,BRASS	13.06
TP2505-SS	TEEJET TIP,ST.STL.	16.06	TP650033-SS	TEEJET TIP,ST.STL.	35.88
TP2506-SS	TEEJET TIP,ST.STL.	16.06	TP650050	TEEJET TIP,BRASS	5.87
TP2507-SS	TEEJET TIP,ST.STL.	16.06	TP650050-SS	TEEJET TIP,ST.STL.	35.88
TP2508-SS	TEEJET TIP,ST.STL.	16.06	TP650067	TEEJET TIP,BRASS	6.29
TP2510-SS	TEEJET TIP,ST.STL.	16.06	TP650067-SS	TEEJET TIP,ST.STL.	35.88
TP2520-SS	TEEJET TIP,ST.STL.	16.06	TP6501	TEEJET TIP,BRASS	6.29
TP3002E-SS	TEEJET TIP, ST. STL.	16.87	TP6501-SS	TEEJET TIP,ST.STL.	16.06
TP3003E-SS	TEEJET TIP, ST. STL.	16.87	TP65015	TEEJET TIP,BRASS	6.29
TP4001-SS	TEEJET TIP,ST.STL.	16.06	TP65015-SS	TEEJET TIP,ST.STL.	16.06
TP40015-SS	TEEJET TIP,ST.STL.	16.06	TP65015E	TEEJET TIP,BRASS	6.39
TP40015E	TEEJET TIP BRASS	6.39	TP6501E	TEEJET TIP BRASS	6.39
TP40015E-SS	TEEJET TIP ST.STL.	16.35	TP6501E-SS	TEEJET TIP, SS	16.35
TP4001E	TEEJET TIP BRASS	6.39	TP6502	TEEJET TIP,BRASS	6.29
TP4001E-SS	TEEJET TIP ST.STL.	16.35	TP6502-SS	TEEJET TIP,ST.STL.	16.06
TP4002-SS	TEEJET TIP,ST.STL.	16.06	TP65025-SS	TEEJET TIP,ST.STL.	16.06
TP40025-SS	TEEJET TIP,ST.STL.	16.06	TP6502E	TEEJET TIP,BRASS	6.39
TP4002E	TEEJET TIP BRASS	6.39	TP6502E-SS	TEEJET TIP,ST.STL.	16.35
TP4002E-SS	TEEJET TIP,ST.STL.	16.35	TP6503	TEEJET TIP,BRASS	6.29
TP4003-SS	TEEJET TIP,ST.STL.	16.06	TP6503-SS	TEEJET TIP,ST.STL.	16.06

PART NO.	DESCRIPTION	U.S.DOLLARS	PART NO.	DESCRIPTION	U.S.DOLLARS
TP65035-SS	TEEJET TIP,STL	16.06	TP6560E	TEEJET TIP,BRASS	6.09
TP6503E	TEEJET TIP,BRASS	6.39	TP6560L	TEEJET TIP,BRASS	28.92
TP6503E-SS	TEEJET TIP, ST. STL	16.35	TP6560L-SS	TEEJET TIP,STL	69.10
TP6503LP-SS	TEEJET TIP LOW PRES.	22.91	TP730023	TEEJET TIP,BRASS	13.06
TP6504	TEEJET TIP,BRASS	6.29	TP730023-SS	TEEJET TIP,STL	35.88
TP6504-HSS	TEEJET TIP,HARD.SS	22.10	TP730039	TEEJET TIP,BRASS	13.06
TP6504-SS	TEEJET TIP,STL	16.06	TP730039-SS	TEEJET TIP,STL	35.88
TP6504E	TEEJET TIP,BRASS	6.39	TP730077	TEEJET TIP,BRASS	6.39
TP6504E-SS	TEEJET TIP, SS	16.35	TP730077-HSS	TEEJET TIP,HARD.SS	44.39
TP6504LP-SS	TEEJET TIP LOW PRES.	22.91	TP730077-SS	TEEJET TIP,STL	35.88
TP6505	TEEJET TIP,BRASS	6.29	TP730116	TEEJET TIP,BRASS	6.39
TP6505-HSS	TEEJET TIP,HARD.SS	22.10	TP730116-SS	TEEJET TIP,STL	16.35
TP6505-SS	TEEJET TIP,STL	16.06	TP730154	TEEJET TIP,BRASS	6.39
TP6505E	TEEJET TIP,BRASS	6.39	TP730154-SS	TEEJET TIP,STL	16.35
TP6505E-SS	TEEJET TIP, SS	16.35	TP730231	TEEJET TIP,BRASS	6.39
TP6506	TEEJET TIP,BRASS	6.29	TP730231-SS	TEEJET TIP,STL	16.35
TP6506-HSS	TEEJET TIP,HARD.SS	22.10	TP730308	TEEJET TIP,BRASS	6.39
TP6506-SS	TEEJET TIP,STL	16.06	TP730308-SS	TEEJET TIP,STL	16.35
TP6506E	TEEJET TIP,BRASS	6.39	TP730385	TEEJET TIP,BRASS	6.39
TP6506E-SS	TEEJET TIP, SS	16.35	TP730385-SS	TEEJET TIP,STL	16.35
TP6507-HSS	TEEJET TIP,HARD.SS	22.10	TP730462	TEEJET TIP,BRASS	6.39
TP6507-SS	TEEJET TIP,STL	16.06	TP730462-HSS	TEEJET TIP,HARD.SS	22.47
TP6508	TEEJET TIP,BRASS	6.29	TP730462-SS	TEEJET TIP,STL	16.35
TP6508-HSS	TEEJET TIP,HARD.SS	22.10	TP730616-SS	TEEJET TIP,STL	16.35
TP6508-SS	TEEJET TIP,STL	16.06	TP730770-HSS	TEEJET TIP,HARD.SS	22.47
TP6508E	TEEJET TIP,BRASS	6.39	TP730770-SS	TEEJET TIP,STL	16.35
TP6508E-SS	TEEJET TIP, SS	16.35	TP730924-HSS	TEEJET TIP,HARD.SS	22.47
TP6508LP	TEEJET TIP LOW PRES.	9.34	TP730924-SS	TEEJET TIP,STL	16.35
TP6509-SS	TEEJET TIP,STL	16.06	TP800039-SS	TEEJET TIP,STL	35.88
TP6510	TEEJET TIP,BRASS	6.29	TP800050	TEEJET TIP,BRASS	6.29
TP6510-HSS	TEEJET TIP,HARD.SS	22.10	TP800050-HSS	TEEJET TIP,HARD.SS	44.39
TP6510-SS	TEEJET TIP,STL	16.06	TP800050-SS	TEEJET TIP,STL	35.88
TP65100L	TEEJET TIP,BRASS	28.92	TP800067	TEEJET TIP,BRASS	6.29
TP65100L-SS	TEEJET TIP,STL	69.10	TP800067-HSS	TEEJET TIP,HARD.SS	44.39
TP6510E	TEEJET TIP,BRASS	6.39	TP800067-SS	TEEJET TIP,STL	35.88
TP6510LP-SS	TEEJET TIP LOW PRES.	22.91	TP8001	TEEJET TIP,BRASS	6.29
TP6515	TEEJET TIP,BRASS	6.29	TP8001-HSS	TEEJET TIP,HARD.SS	22.10
TP6515-HSS	TEEJET TIP,HARD.SS	22.10	TP8001-SS	TEEJET TIP,STL	16.06
TP6515-SS	TEEJET TIP,STL	16.06	TP80015	TEEJET TIP,BRASS	6.29
TP65150L	TEEJET TIP,BRASS	28.92	TP80015-HSS	TEEJET TIP,HARD.SS	22.10
TP65150L-SS	TEEJET TIP,STL	69.10	TP80015-SS	TEEJET TIP,STL	16.06
TP6515E	TEEJET TIP,BRASS	6.39	TP80015E	TEEJET TIP,BRASS	6.39
TP6520	TEEJET TIP,BRASS	6.29	TP80015E-SS	TEEJET TIP,STL	16.35
TP6520-HSS	TEEJET TIP,HARD.SS	22.10	TP80015EVS	VISIFLO TEEJET TIP	9.34
TP6520-SS	TEEJET TIP,STL	16.06	TP80015LP-SS	TEEJET TIP LOW PRES.	22.91
TP65200L	TEEJET TIP,BRASS	28.92	TP80015VK	TEEJET TIP CERAMIC	10.70
TP65200L-SS	TEEJET TIP STL	69.10	TP80015VP	TEEJET TIP POLYMER	1.38
TP6520LP-SS	TEEJET TIP LOW PRES.	22.91	TP80015VS	VISIFLO TEEJET TIP	9.34
TP65250L-SS	TEEJET TIP,STL	69.10	TP8001E	TEEJET TIP,BRASS	6.39
TP6530	TEEJET TIP,BRASS	6.29	TP8001E-HSS	TEEJET TIP,HARD.SS	22.47
TP6530-HSS	TEEJET TIP,HARD.SS	22.10	TP8001E-SS	TEEJET TIP,STL	16.35
TP6530-SS	TEEJET TIP,STL	16.06	TP8001EVS	VISIFLO TEEJET TIP	9.34
TP65300L	TEEJET TIP BRASS	28.92	TP8001LP	TEEJET TIP LOW PRES.	9.34
TP65300L-SS	TEEJET TIP,STL	69.10	TP8001LP-SS	TEEJET TIP LOW PRES.	22.91
TP6540	TEEJET TIP,BRASS	6.29	TP8001VK	TEEJET TIP CERAMIC	10.70
TP6540-HSS	TEEJET TIP,HARD.SS	22.10	TP8001VS	VISIFLO TEEJET TIP	9.34
TP6540-SS	TEEJET TIP,STL	16.06	TP8002	TEEJET TIP,BRASS	6.29
TP6540L	TEEJET TIP,BRASS	28.92	TP8002-HSS	TEEJET TIP,HARD.SS	22.10
TP6550	TEEJET TIP,BRASS	6.29	TP8002-SS	TEEJET TIP,STL	16.06
TP6550-HSS	TEEJET TIP,HARD.SS	22.10	TP8002E	TEEJET TIP,BRASS	6.39
TP6550-SS	TEEJET TIP,STL	16.06	TP8002E-HSS	TEEJET TIP,HARD.SS	22.47
TP6550L-SS	TEEJET TIP,STL	69.10	TP8002E-SS	TEEJET TIP,STL	16.35
TP6560	TEEJET TIP,BRASS	6.29	TP8002EVS	VISIFLO TEEJET TIP	9.34
TP6560-SS	TEEJET TIP,STL	16.06	TP8002LP	TEEJET TIP LOW PRES.	9.34

PART NO.	DESCRIPTION	U.S.DOLLARS	PART NO.	DESCRIPTION	U.S.DOLLARS
TP8002LP-SS	TEEJET TIP LOW PRES.	22.91	TP8010E-SS	TEEJET TIP,ST.STL.	16.35
TP8002VK	TEEJET TIP CERAMIC	8.08	TP8010LP	TEEJET TIP LOW PRES.	9.34
TP8002VP	TEEJET TIP POLYMER	1.38	TP8010LP-SS	TEEJET TIP LOW PRES.	22.91
TP8002VS	VISIFLO TEEJET TIP	9.34	TP8012-SS	TEEJET TIP,ST.STL.	16.06
TP8003	TEEJET TIP,BRASS	6.29	TP8015	TEEJET TIP,BRASS	6.29
TP8003-HSS	TEEJET TIP,HARD.SS	22.10	TP8015-HSS	TEEJET TIP,HARD.SS	22.10
TP8003-SS	TEEJET TIP,ST.STL.	16.06	TP8015-SS	TEEJET TIP,ST.STL.	16.06
TP8003E	TEEJET TIP,BRASS	6.39	TP80150L	TEEJET TIP,BRASS	28.92
TP8003E-SS	TEEJET TIP,ST.STL.	16.35	TP80150L-SS	TEEJET TIP,ST.STL.	69.10
TP8003EVS	VISIFLO TEEJET TIP	9.34	TP8015E	TEEJET TIP,BRASS	6.39
TP8003LP	TEEJET TIP LOW PRES.	9.34	TP8015E-SS	TEEJET TIP,ST.STL.	16.35
TP8003LP-SS	TEEJET TIP LOW PRES.	22.91	TP8020	TEEJET TIP,BRASS	6.29
TP8003VP	TEEJET TIP POLYMER	1.38	TP8020-HSS	TEEJET TIP,HARD.SS	22.10
TP8003VS	VISIFLO TEEJET TIP	9.34	TP8020-SS	TEEJET TIP,ST.STL.	16.06
TP8004	TEEJET TIP,BRASS	6.29	TP80200L	TEEJET TIP,BRASS	27.70
TP8004-HSS	TEEJET TIP,HARD.SS	22.10	TP80200L-SS	TEEJET TIP,ST.STL.	69.10
TP8004-SS	TEEJET TIP,ST.STL.	16.06	TP8020E	TEEJET TIP,BRASS	6.39
TP8004E	TEEJET TIP,BRASS	6.39	TP8020E-SS	TEEJET TIP,ST.STL.	16.35
TP8004E-HSS	TEEJET TIP,HARD.SS	22.47	TP8020EG	WASHJET TIP W/VANE	28.29
TP8004E-SS	TEEJET TIP,ST.STL.	16.35	TP8025	TEEJET TIP,BRASS	6.29
TP8004EVS	VISIFLO TEEJET TIP	9.34	TP80250L	TEEJET TIP,BRASS	28.92
TP8004LP	TEEJET TIP LOW PRES.	9.34	TP80250L-SS	TEEJET TIP,ST.STL.	69.10
TP8004LP-SS	TEEJET TIP LOW PRES.	22.91	TP8030	TEEJET TIP,BRASS	6.29
TP8004VP	TEEJET TIP, POLYMER	1.38	TP8030-HSS	TEEJET TIP,HARD.SS	22.10
TP8004VS	VISIFLO TEEJET TIP	9.34	TP8030-SS	TEEJET TIP,ST.STL.	16.06
TP8005	TEEJET TIP,BRASS	6.29	TP80300L	TEEJET TIP,BRASS	28.92
TP8005-HSS	TEEJET TIP,HARD.SS	22.10	TP80300L-SS	TEEJET TIP,ST.STL.	69.10
TP8005-SS	TEEJET TIP,ST.STL.	16.06	TP8030E	TEEJET TIP,BRASS	6.39
TP8005E	TEEJET TIP,BRASS	6.39	TP8030E-SS	TEEJET TIP,ST.STL.	16.35
TP8005E-SS	TEEJET TIP,ST.STL.	16.35	TP8040	TEEJET TIP,BRASS	6.29
TP8005EVS	VISIFLO TEEJET TIP	9.34	TP8040-HSS	TEEJET TIP,HARD.SS	22.10
TP8005LP	TEEJET TIP LOW PRES.	9.34	TP8040-SS	TEEJET TIP,ST.STL.	16.06
TP8005LP-SS	TEEJET TIP LOW PRES.	22.91	TP8040E	TEEJET TIP,BRASS	6.39
TP8005VP	TEEJET TIP POLYMER	1.38	TP8040L	TEEJET TIP,BRASS	28.92
TP8005VS	VISIFLO TEEJET TIP	9.34	TP8040L-SS	TEEJET TIP,ST.STL.	69.10
TP8006	TEEJET TIP,BRASS	6.29	TP8050	TEEJET TIP,BRASS	6.29
TP8006-HSS	TEEJET TIP,HARD.SS	22.10	TP8050-HSS	TEEJET TIP,HARD.SS	22.10
TP8006-SS	TEEJET TIP,ST.STL.	16.06	TP8050-SS	TEEJET TIP,ST.STL.	16.06
TP8006E	TEEJET TIP,BRASS	6.39	TP8050L	TEEJET TIP,BRASS	28.92
TP8006E-SS	TEEJET TIP,ST.STL.	16.35	TP8050L-SS	TEEJET TIP,ST.STL.	69.10
TP8006EVS	VISIFLO TEEJET TIP	9.34	TP8060	TEEJET TIP,BRASS	6.29
TP8006LP	TEEJET TIP LOW PRES.	9.34	TP8060-SS	TEEJET TIP,ST.STL.	16.06
TP8006LP-SS	TEEJET TIP LOW PRES.	22.91	TP8060L	TEEJET TIP,BRASS	27.06
TP8006VP	TEEJET TIP POLYMER	1.38	TP8060L-SS	TEEJET TIP,ST.STL.	69.10
TP8006VS	VISIFLO TEEJET TIP	9.34	TP950050	TEEJET TIP BRASS	6.29
TP8007-HSS	TEEJET TIP HARD.SS	22.10	TP950050-SS	TEEJET TIP,ST.STL.	35.88
TP8007-SS	TEEJET TIP,ST.STL.	16.06	TP950067-SS	TEEJET TIP,ST.STL.	35.88
TP8008	TEEJET TIP,BRASS	6.29	TP9501-HSS	TEEJET TIP,HARD.SS	22.10
TP8008-HSS	TEEJET TIP,HARD.SS	22.10	TP9501-SS	TEEJET TIP,ST.STL.	16.06
TP8008-SS	TEEJET TIP,ST.STL.	16.06	TP95015-SS	TEEJET TIP,ST.STL.	16.06
TP8008E	TEEJET TIP,BRASS	6.39	TP95015EVS	VISIFLO TEEJET TIP	9.34
TP8008E-SS	TEEJET TIP,ST.STL.	16.35	TP95015LP	TEEJET TIP LOW PRES.	9.34
TP8008EVS	VISIFLO TEEJET TIP	9.34	TP9501E	TEEJET TIP,BRASS	6.39
TP8008LP	TEEJET TIP LOW PRES.	9.34	TP9501E-SS	TEEJET TIP,ST.STL.	16.35
TP8008LP-SS	TEEJET TIP LOW PRES.	22.91	TP9501EVS	VISIFLO TEEJET TIP	9.34
TP8008VP	TEEJET TIP POLYMER	1.38	TP9502	TEEJET TIP,BRASS	6.29
TP8008VS	VISIFLO TEEJET TIP	9.34	TP9502-HSS	TEEJET TIP,HARD.SS	22.10
TP8009-SS	TEEJET TIP,ST.STL.	16.06	TP9502-SS	TEEJET TIP,ST.STL.	16.06
TP8010	TEEJET TIP,BRASS	6.29	TP9502E	TEEJET TIP,BRASS	6.39
TP8010-HSS	TEEJET TIP,HARD.SS	22.10	TP9502E-SS	TEEJET TIP,ST.STL.	16.35
TP8010-SS	TEEJET TIP,ST.STL.	16.06	TP9502EVS	VISIFLO TEEJET TIP	9.34
TP80100L	TEEJET TIP,BRASS	28.92	TP9503	TEEJET TIP,BRASS	6.29
TP80100L-SS	TEEJET TIP,ST.STL.	69.10	TP9503-HSS	TEEJET TIP,HARD.SS	22.10
TP8010E	TEEJET TIP,BRASS	6.39	TP9503-SS	TEEJET TIP,ST.STL.	16.06

PART NO.	DESCRIPTION	U.S.DOLLARS	PART NO.	DESCRIPTION	U.S.DOLLARS
TP9503E	TEEJET TIP,BRASS	6.39	TT110015-VK-CE	TT CERAMIC CE CAP ASSM W/ PLUG	16.11
TP9503EVS	VISIFLO TEEJET TIP	9.34	TT110015-VP	TURBO TEEJET TIP	9.84
TP9504	TEEJET TIP,BRASS	6.29	TT110015-VP-CE	TT CE CAP ASSM W/PLUG	11.62
TP9504-HSS	TEEJET TIP,HARD.SS	22.10	TT11002-VK	TURBO TEEJET TIP CERAMIC	14.34
TP9504-SS	TEEJET TIP,ST.STL.	16.06	TT11002-VK-CE	TT CERAMIC CE CAP ASSM W/ PLUG	16.11
TP9504E	TEEJET TIP,BRASS	6.39	TT11002-VP	TURBO TEEJET TIP	9.84
TP9504EVS	VISIFLO TEEJET TIP	9.34	TT11002-VP-CE	TT CE CAP ASSM W/PLUG	11.62
TP9505	TEEJET TIP,BRASS	6.29	TT110025-VK	TURBO TEEJET TIP CERAMIC	14.34
TP9505-HSS	TEEJET TIP,HARD.SS	22.10	TT110025-VK-CE	TT CERAMIC CE CAP ASSM W/ PLUG	16.11
TP9505-SS	TEEJET TIP,ST.STL.	16.06	TT110025-VP	TURBO TEEJET TIP	9.84
TP9505E	TEEJET TIP,BRASS	6.39	TT110025-VP-CE	TT CE CAP ASSM W/PLUG	11.62
TP9505EVS	VISIFLO TEEJET TIP	9.34	TT11003-VK	TURBO TEEJET TIP CERAMIC	14.34
TP9506-HSS	TEEJET TIP,HARD.SS	22.10	TT11003-VK-CE	TT CERAMIC CE CAP ASSM W/ PLUG	16.11
TP9506-SS	TEEJET TIP,ST.STL.	16.06	TT11003-VP	TURBO TEEJET TIP	9.84
TP9506E	TEEJET TIP, BR	6.39	TT11003-VP-CE	TT CE CAP ASSM W/PLUG	11.62
TP9506EVS	VISIFLO TEEJET TIP	9.34	TT11004-VK	TURBO TEEJET TIP CERAMIC	14.34
TP9508	TEEJET TIP,BRASS	6.29	TT11004-VK-CE	TT CERAMIC CE CAP ASSM W/ PLUG	16.11
TP9508-HSS	TEEJET TIP,HARD.SS	22.10	TT11004-VP	TURBO TEEJET TIP	9.84
TP9508-SS	TEEJET TIP,ST.STL.	16.06	TT11004-VP-CE	TT CE CAP ASSM W/PLUG	11.62
TP9508EVS	VISIFLO TEEJET TIP	9.34	TT11005-VK	TURBO TEEJET TIP CERAMIC	14.34
TP9509-SS	TEEJET TIP,ST.STL.	16.06	TT11005-VK-CE	TT CERAMIC CE CAP ASSM W/ PLUG	16.11
TP9510	TEEJET TIP,BRASS	6.29	TT11005-VP	TURBO TEEJET TIP	9.84
TP9510-HSS	TEEJET TIP,HARD.SS	22.10	TT11005-VP-CE	TT CE CAP ASSM W/PLUG	11.62
TP9510-SS	TEEJET TIP,ST.STL.	16.06	TT11006-VK	TURBO TEEJET TIP CERAMIC	14.34
TP9515-SS	TEEJET TIP,ST.STL.	16.06	TT11006-VK-CE	TT CERAMIC CE CAP ASSM W/ PLUG	16.11
TP9516-SS	TEEJET TIP, SS	16.06	TT11006-VP	TURBO TEEJET TIP	9.84
TP9518-SS	TEEJET TIP, SS	16.06	TT11006-VP-CE	TT CE CAP ASSM W/PLUG	11.62
TP9520-HSS	TEEJET TIP,HARD.SS	22.10	TT11008-VK	TURBO TEEJET TIP CERAMIC	14.34
TP9520-SS	TEEJET TIP,ST.STL.	16.06	TT11008-VK-CE	TT CERAMIC CE CAP ASSM W/ PLUG	16.11
TP9530	TEEJET TIP,BRASS	6.29	TT11008-VP	TURBO TEEJET TIP	9.84
TP9530-SS	TEEJET TIP,ST.STL.	16.06	TT11008-VP-CE	TT CE CAP ASSM W/PLUG	11.62
TP9540	TEEJET TIP,BRASS	6.29	TT11010-VP	LARGE CAPACITY TURBO TEEJET TIP	11.80
TP9540-SS	TEEJET TIP,ST.STL.	16.06	TT11010-VP-CE	TT CE CAP ASSM W/PLUG	14.54
TP9550	TEEJET TIP,BRASS	6.29	TT11012-VP	LARGE CAPACITY TURBO TEEJET TIP	11.80
TP9550-SS	TEEJET TIP,ST.STL.	16.06	TT11012-VP-CE	TT CE CAP ASSM W/PLUG	14.54
TP9560	TEEJET TIP,BRASS	6.29	TT11001-VP	TTI11001-VP ORANGE TURBO/ AI AIR IND. VISIFLO TIP	16.83
TP9560-HSS	TEEJET TIP,HARD,SS	22.10	TTI11001-VP-CE	TTI E CAP ASSM W/PLUG	18.59
TP9560-SS	TEEJET TIP,ST.STL.	16.06	TTI11001-VP-CE-10X	TTI CE CAP ASSM W/PLUG-10 PACK	185.62
TPU250033-SS	UNIJET TIP, 303SS	35.88	TTI110015-VP	TT INDUCTION TIP	16.83
TQ150-01	TEEJET TIP,BRASS	13.63	TTI110015-VP-CE	TTI CE CAP ASSM W/PLUG	18.59
TQ150-01-SS	TEEJET TIP ST.STL.	24.62	TTI110015-VP-CE-10X	TTI CE CAP ASSM W/PLUG-10 PACK	185.62
TQ150-015	TEEJET TIP,BRASS	13.63	TTI11002-VP	TT INDUCTION TIP	16.83
TQ150-015-SS	TEEJET TIP,ST.STEEL	24.62	TTI11002-VP-CE	TTI CE CAP ASSM W/PLUG	18.59
TQ150-02	TEEJET TIP,BRASS	13.63	TTI11002-VP-CE-10X	TTI CE CAP ASSM W/PLUG-10 PACK	185.62
TQ150-02-SS	TEEJET TIP,ST.STL.	24.62	TTI110025-VP	TT INDUCTION TIP	16.83
TQ150-03	TEEJET TIP,BRASS	13.63	TTI110025-VP-CE	TTI CE CAP ASSM W/PLUG	18.59
TQ150-03-SS	TEEJET TIP,ST.STL.	24.62	TTI110025-VP-CE-10X	TTI CE CAP ASSM W/PLUG-10 PACK	185.62
TQ150-04	TEEJET TIP,BRASS	13.63	TTI11003-VP	TT INDUCTION TIP	16.83
TQ150-04-SS	TEEJET TIP,ST.STL.	24.62	TTI11003-VP-CE	TTI CE CAP ASSM W/PLUG	18.59
TQ150-05	TEEJET TIP,BRASS	13.63	TTI11003-VP-CE-10X	TTI CE CAP ASSM W/PLUG-10 PACK	185.62
TQ150-05-SS	TEEJET TIP,ST.STL.	24.62	TTI110015-VP	TT INDUCTION TIP	16.83
TQ150-06	TEEJET TIP,BRASS	13.63	TTI110015-VP-CE	TTI CE CAP ASSM W/PLUG	18.59
TQ150-06-SS	TEEJET TIP,ST.STL.	24.62	TTI110015-VP-CE-10X	TTI CE CAP ASSM W/PLUG-10 PACK	185.62
TQ150-08	TEEJET TIP,BRASS	13.63	TTI110015-VP-CE-10X	TTI CE CAP ASSM W/PLUG-10 PACK	185.62
TQ150-08-SS	TEEJET TIP,ST.STL.	24.62	TTI11003-VP	TT INDUCTION TIP	16.83
TQ150-09	TEEJET TIP,BRASS	13.63	TTI11003-VP-CE	TTI CE CAP ASSM W/PLUG	18.59
TQ150-09-SS	TEEJET TIP,ST.STL.	24.62	TTI11003-VP-CE-10X	TTI CE CAP ASSM W/PLUG-10 PACK	185.62
TT11001-VK	TURBO TEEJET TIP CERAMIC	14.34			
TT11001-VK-CE	TT CERAMIC CE CAP ASSM W/ PLUG	16.11			
TT11001-VP	TURBO TEEJET TIP	9.84			
TT11001-VP-CE	TT CE CAP ASSM W/PLUG	11.62			
TT110015-VK	TURBO TEEJET TIP CERAMIC	14.34			



# COMPREHENSIVE LIST

PART NO.	DESCRIPTION	U.S.DOLLARS	PART NO.	DESCRIPTION	U.S.DOLLARS
TTI11004-VP	TT INDUCTION TIP	16.83	TX-12	CONEJET TIP,BRASS	8.81
TTI11004-VP-CE	TTI CE CAP ASSM W/PLUG	18.59	TX-14	CONEJET TIP,BRASS	8.81
TTI11004-VP-CE-10X	TTI CE CAP ASSM W/PLUG-10 PACK	185.62	TX-18	CONEJET TIP,BRASS	8.81
TTI11005-VP	TT INDUCTION TIP	16.83	TX-2	CONEJET TIP,BRASS	8.81
TTI11005-VP-CE	TTI CE CAP ASSM W/PLUG	18.59	TX-2.5	CONEJET TIP,BRASS	8.81
TTI11005-VP-CE-10X	TTI CE CAP ASSM W/PLUG-10 PACK	185.62	TX-22	CONEJET TIP,BRASS	8.81
TTI11006-VP	TT INDUCTION TIP	16.83	TX-26	CONEJET TIP,BRASS	8.81
TTI11006-VP-CE	TTI CE CAP ASSM W/PLUG	18.59	TX-3	CONEJET TIP,BRASS	8.81
TTI11006-VP-CE-10X	TTI CE CAP ASSM W/PLUG-10 PACK	185.62	TX-4	CONEJET TIP,BRASS	8.81
TTI11008-VP	TT INDUCTION TIP	19.67	TX-5	CONEJET TIP,BRASS	8.81
TTI11008-VP-CE	TTI CE CAP ASSM W/PLUG	22.34	TX-6	CONEJET TIP,BRASS	8.81
TTI11008-VP-CE-10X	TTI CE CAP ASSM W/PLUG-10 PACK	222.98	TX-8	CONEJET TIP,BRASS	8.81
TTI11010-VP	TT INDUCTION TIP	19.67	TX-SS.60	CONEJET TIP,ST.STL.	55.14
TTI11010-VP-CE	TTI CE CAP ASSM W/PLUG	22.34	TX-SS1	CONEJET TIP,ST.STL.	55.14
TTI11010-VP-CE-10X	TTI CE CAP ASSM W/PLUG-10 PACK	222.98	TX-SS1.25	CONEJET TIP,ST.STL.	55.14
TTI60-110025VP	TTI TWINJET TIP/CAP	21.03	TX-SS1.5	CONEJET TIP,ST.STL.	55.14
TTI60-11002VP	TTI TWINJET TIP/CAP	21.03	TX-SS10	CONEJET TIP,ST.STL.	55.14
TTI60-11003VP	TTI TWINJET TIP/CAP	21.03	TX-SS12	CONEJET TIP,ST.STL.	55.14
TTI60-11004VP	TTI TWINJET TIP/CAP	21.03	TX-SS14	CONEJET TIP,ST.STL.	55.14
TTI60-11005VP	TTI TWINJET TIP/CAP	21.03	TX-SS18	CONEJET TIP,ST.STL.	55.14
TTI60-11006VP	TTI TWINJET TIP/CAP	21.03	TX-SS2	CONEJET TIP,ST.STL.	55.14
TTI60-11008VP	TTI TWINJET TIP/CAP	21.03	TX-SS2.5	CONEJET TIP,ST.STL.	55.14
TTJ60-110025VP	TURBO TWINJET TIP	11.80	TX-SS22	CONEJET TIP,ST.STL.	55.14
TTJ60-110025VP-CE	TTJ60 CE CAP ASSM W/PLUG	13.58	TX-SS26	CONEJET TIP,ST.STL.	55.14
TTJ60-110025VP-CE-10X	TTJ60 CE CAP ASSM W/PLUG - 10 PACK	135.56	TX-SS3	CONEJET TIP,ST.STL.	55.14
TTJ60-11002VP	TURBO TWINJET TIP	11.80	TX-SS4	CONEJET TIP,ST.STL.	55.14
TTJ60-11002VP-CE	TTJ60 CAP ASSM W/PLUG	13.58	TX-SS5	CONEJET TIP,ST.STL.	55.14
TTJ60-11002VP-CE-10X	TTJ60 CE CAP ASSM W/PLUG - 10 PACK	135.56	TX-SS6	CONEJET TIP,ST.STL.	55.14
TTJ60-11003VP	TURBO TWINJET TIP	11.80	TX-SS8	CONEJET TIP,ST.STL.	55.14
TTJ60-11003VP-CE	TTJ60 CE CAP ASSM W/PLUG	13.58	TX-VK10	VISIFLO CONEJET.CERM.	8.92
TTJ60-11003VP-CE-10X	TTJ60 CE CAP ASSM W/PLUG - 10 PACK	135.56	TX-VK12	VISIFLO CONEJET.CERM.	8.92
TTJ60-11004VP	TURBO TWINJET TIP	11.80	TX-VK18	VISIFLO CONEJET.CERM.	8.92
TTJ60-11004VP-CE	TTJ60 CE CAP ASSM W/PLUG	13.58	TX-VK26	VISIFLO CONEJET.CERM.	8.92
TTJ60-11004VP-CE-10X	TTJ60 CE CAP ASSM W/PLUG - 10 PACK	135.56	TX-VK3	VISIFLO CONEJET.CERM.	8.92
TTJ60-11005VP	TURBO TWINJET TIP	11.80	TX-VK4	VISIFLO CONEJET.CERM.	8.92
TTJ60-11005VP-CE	TTJ60 CE CAP ASSM W/PLUG	13.58	TX-VK6	VISIFLO CONEJET.CERM.	8.92
TTJ60-11005VP-CE-10X	TTJ60 CE CAP ASSM W/PLUG - 10 PACK	135.56	TX-VK8	VISIFLO CONEJET.CERM.	8.92
TTJ60-11006VP	TURBO TWINJET TIP	11.80	TX-VS1	VISIFLO CONEJET,SS	9.85
TTJ60-11006VP-CE	TTJ60 CE CAP ASSM W/PLUG	13.58	TX-VS10	VISIFLO CONEJET,SS	9.85
TTJ60-11006VP-CE-10X	TTJ60 CE CAP ASSM W/PLUG - 10 PACK	135.56	TX-VS12	VISIFLO CONEJET,SS	9.85
TTJ60-11008VP	TURBO TWINJET TIP	11.80	TX-VS18	VISIFLO CONEJET,SS	9.85
TTJ60-11008VP-CE	TTJ60 CE CAP ASSM W/PLUG	13.58	TX-VS2	VISIFLO CONEJET,SS	9.85
TTJ60-11008VP-CE-10X	TTJ60 CE CAP ASSM W/PLUG - 10 PACK	135.56	TX-VS26	VISIFLO CONEJET,SS	9.85
TTJ60-11010VP	TURBO TWINJET TIP	11.80	TX-VS3	VISIFLO CONEJET,SS	9.85
TTJ60-11010VP-CE	TTJ60 CE CAP ASSM W/PLUG	13.58	TX-VS4	VISIFLO CONEJET,SS	9.85
TTJ60-11010VP-CE-10X	TTJ60 CE CAP ASSM W/PLUG - 10 PACK	135.56	TX-VS6	VISIFLO CONEJET,SS	9.85
TX-.50	CONEJET TIP,BRASS	8.81	TX-VS8	VISIFLO CONEJET,SS	9.85
TX-.60	CONEJET TIP,BRASS	8.81	TXA800050VK	CERAMIC CONEJET	8.92
TX-1	CONEJET TIP,BRASS	8.81	TXA800067VK	CERAMIC CONEJET	8.92
TX-1.25	CONEJET TIP,BRASS	8.81	TXA80015VK	CERAMIC CONEJET	8.92
TX-1.5	CONEJET TIP,BRASS	8.81	TXA8001VK	CERAMIC CONEJET	8.92
TX-10	CONEJET TIP,BRASS	8.81	TXA8002VK	CERAMIC CONEJET	8.92
			TXA8003VK	CERAMIC CONEJET	8.92
			TXA8004VK	CERAMIC CONEJET	8.92
			TXB800050VK	CERAMIC CONEJET	8.92
			TXB800067VK	CERAMIC CONEJET	8.92
			TXB80015VK	CERAMIC CONEJET	8.92
			TXB8001VK	CERAMIC CONEJET	8.92
			TXB8002VK	CERAMIC CONEJET	8.92
			TXB8003VK	CERAMIC CONEJET	8.92
			TXB8004VK	CERAMIC CONEJET	8.92
			TXR800053VK	TXR CONEJET TIP CERAMIC	8.70
			TXR800053VK-100X	TXR CONEJET 100X	864.91
			TXR800071VK	TXR CONEJET TIP CERAMIC	8.70

PART NO.	DESCRIPTION	U.S.DOLLARS	PART NO.	DESCRIPTION	U.S.DOLLARS
TXR800071VK-100X	TXR CONEJET 100X	864.91	XE15002-VP-CE-10X	XE EXTENDED EVEN TIP CAP ASSM W/PLUG - 10 PACK	76.30
TXR80013VK	TXR CONEJET TIP CERAMIC	8.70	XE15004-VP	XE EXTENDED EVEN TIP	6.07
TXR80013VK-100X	TXR CONEJET 100X	864.91	XE15004-VP-CE	XE EXTENDED EVEN TIP CAP ASSM W/PLUG	7.64
TXR80015VK	TXR CONEJET TIP CERAMIC	8.70	XE15004-VP-CE-10X	XE EXTENDED EVEN TIP CAP ASSM W/PLUG - 10 PACK	76.30
TXR80015VK-100X	TXR CONEJET 100X	864.91	XE15006-VP	XE EXTENDED EVEN TIP	6.07
TXR80017VK	TXR CONEJET TIP CERAMIC	8.70	XE15006-VP-CE	XE EXTENDED EVEN TIP CAP ASSM W/PLUG	7.64
TXR80017VK-100X	TXR CONEJET 100X	864.91	XE15006-VP-CE-10X	XE EXTENDED EVEN TIP CAP ASSM W/PLUG - 10 PACK	76.30
TXR8001VK	TXR CONEJET TIP CERAMIC	8.70	XE15008-VP	XE EXTENDED EVEN TIP	6.07
TXR8001VK-100X	TXR CONEJET 100X	864.91	XE15008-VP-CE	XE EXTENDED EVEN TIP CAP ASSM W/PLUG	7.64
TXR80028VK	TXR CONEJET TIP CERAMIC	8.70	XE15008-VP-CE-10X	XE EXTENDED EVEN TIP CAP ASSM W/PLUG - 10 PACK	76.30
TXR80028VK-100X	TXR CONEJET 100X	864.91	XR110015-VP	VISIFLO TEEJET TIP	4.72
TXR8002VK	TXR CONEJET TIP CERAMIC	8.70	XR110015-VP-CE	XR CE CAP ASSM W/PLUG	6.53
TXR8002VK-100X	TXR CONEJET 100X	864.91	XR110015VB	TEEJET SPRAY TIP,XR	9.70
TXR80036VK	TXR CONEJET TIP CERAMIC	8.70	XR110015VS	TEEJET SPRAY TIP SS	10.44
TXR80036VK-100X	TXR CONEJET 100X	864.91	XR11001VB	TEEJET SPRAY TIP,XR	9.70
TXR8003VK	TXR CONEJET TIP CERAMIC	8.70	XR11001VS	TEEJET SPRAY TIP,XR	10.44
TXR8003VK-100X	TXR CONEJET 100X	864.91	XR11002-VK	VISIFLO TEEJET TIP	8.08
TXR80049VK	TXR CONEJET TIP CERAMIC	8.70	XR11002-VP	VISIFLO TEEJET TIP	4.72
TXR80049VK-100X	TXR CONEJET 100X	864.91	XR11002-VP-CE	XR CE CAP ASSM W/PLUG	6.53
TXR8004VK	TXR CONEJET TIP CERAMIC	8.70	XR11002-VS	TEEJET SPRAY TIP XR	10.44
TXR8004VK-100X	TXR CONEJET 100X	864.91	XR110025-VK	VISIFLO TEEJET TIP	8.08
TY-.60	CONEJET TIP,BRASS	9.49	XR11002VB	TEEJET SPRAY TIP,XR	9.70
TY-1	CONEJET TIP,BRASS	9.49	XR11003-VK	VISIFLO TEEJET TIP	8.08
TY-10	CONEJET TIP,BRASS	9.49	XR11003-VP	VISIFLO TEEJET TIP	4.72
TY-12	CONEJET TIP,BRASS	9.49	XR11003-VS	TEEJET SPRAY TIP XR	10.44
TY-14	CONEJET TIP,BRASS	9.49	XR11003VB	TEEJET SPRAY TIP,XR	9.70
TY-18	CONEJET TIP,BRASS	9.49	XR11004-VK	VISIFLO TEEJET TIP	8.08
TY-2	CONEJET TIP,BRASS	9.49	XR11004-VP	VISIFLO TEEJET TIP	4.72
TY-2.5	CONEJET TIP,BRASS	9.49	XR11004-VS	TEEJET SPRAY TIP XR	10.44
TY-26	CONEJET TIP,BRASS	9.49	XR11004VB	TEEJET SPRAY TIP,XR	9.70
TY-3	CONEJET TIP,BRASS	9.49	XR11005-VK	VISIFLO TEEJET TIP	8.08
TY-4	CONEJET TIP,BRASS	9.49	XR11005-VP	VISIFLO TEEJET TIP	4.72
TY-6	CONEJET TIP,BRASS	9.49	XR11005-VS	TEEJET SPRAY TIP XR	10.44
TY-8	CONEJET TIP,BRASS	9.49	XR11005VB	TEEJET SPRAY TIP,XR	9.70
TY-SS1	CONEJET TIP,ST.STL.	27.90	XR11006-VK	VISIFLO TEEJET TIP	8.08
TY-SS1.5	CONEJET TIP,ST.STL.	27.90	XR11006-VP	VISIFLO TEEJET TIP	4.72
TY-SS10	CONEJET TIP,ST.STL.	27.90	XR11006-VS	TEEJET SPRAY TIP XR	10.44
TY-SS12	CONEJET TIP,ST.STL.	27.90	XR11006VB	TEEJET SPRAY TIP,XR	9.70
TY-SS18	CONEJET TIP,ST.STL.	27.90	XR11008-VK	VISIFLO TEEJET TIP	8.08
TY-SS2	CONEJET TIP,ST.STL.	27.90	XR11008-VP	VISIFLO TEEJET TIP	4.72
TY-SS2.5	CONEJET TIP,ST.STL.	27.90	XR11008-VS	TEEJET SPRAY TIP XR	10.44
TY-SS26	CONEJET TIP,ST.STL.	27.90	XR11008VB	TEEJET SPRAY TIP,XR	9.70
TY-SS3	CONEJET TIP,ST.STL.	27.90	XR11010SS	XR TEEJET TIP,ST.STL	12.38
TY-SS4	CONEJET TIP,ST.STL.	27.90	XR11015SS	XR TEEJET TIP,ST.STL	12.38
TY-SS5	CONEJET TIP ST.STL	27.90	XR80015VS	TEEJET SPRAY TIP SS	10.44
TY-SS6	CONEJET TIP,ST.STL.	27.90	XR8001VS	TEEJET SPRAY TIP,XR	10.44
TY-SS8	CONEJET TIP,ST.STL.	27.90	XR8002VS	TEEJET SPRAY TIP XR	10.44
TZ-1	CONEJET TIP BRASS	9.49	XR8003-VK	VISIFLO TEEJET TIP	8.08
TZ-5	TZ-5 CONEJET TIP BRASS	9.49	XR80035VS	TEEJET SPRAY TIP XR	10.44
TZ-6	CONEJET TIPS BRASS	9.49	XR8003VS	TEEJET SPRAY TIP XR	10.44
TZ-8	CONEJET TIPS BRASS	9.49	XR8004-VK	VISIFLO TEEJET TIP	8.08
VSM-1/2-140	CONT.WASHING NOZ.,NY	223.00	XR8004VS	TEEJET SPRAY TIP XR	10.44
VSM-1/2-190	CONT.WASHING NOZ.,NY	223.00	XR8005-VK	VISIFLO TEEJET TIP	8.08
VSM-1/2-28	CONT.WASHING NOZ.,NY	60.75	XR8005VS	TEEJET SPRAY TIP XR	10.44
VSM-1/2-44	CONT.WASHING NOZ.,NY	60.75	XR8006-VK	VISIFLO TEEJET TIP	8.08
VSM-1/2-90	CONT.WASHING NOZ.,NY	60.75	XR8006VS	TEEJET SPRAY TIP XR	10.44
VSM-3/4-140	CONT.WASHING NOZ.,NY	623.10	XR8008-VK	VISIFLO TEEJET TIP	8.08
VSM-3/4-190	CONT.WASHING NOZ.,NY	623.10			
VSM-3/4-53	CONT.WASHING NOZ.,NY	659.12			
VSM-3/4-90	CONT.WASHING NOZ.,NY, VSM90-240PE8A	623.10			
XE15002-VP	XE EXTENDED EVEN TIP	6.07			
XE15002-VP-CE	XE EXTENDED EVEN TIP CAP ASSM W/PLUG	7.64			



# COMPREHENSIVE LIST

PART NO.	DESCRIPTION	U.S.DOLLARS	PART NO.	DESCRIPTION	U.S.DOLLARS
XR8008VS	TEEJET SPRAY TIP XR	10.44	XRC8002-VK	TEEJET TIP/CAP XR	9.77
XR8010SS	XR TEEJET TIP,STL	12.38	XRC8002-VS	TEEJET TIP/CAP XR	11.99
XR8015SS	XR TEEJET TIP,STL	12.38	XRC8002VK-50-EPR	XR TIP CAP W/ STR	11.54
XRC11002-VK	TEEJET TIP/CAP XR	9.77	XRC8002VK-50-VI	XR TIP CAP W/ STR	13.91
XRC110025-VK	TEEJET TIP/CAP XR	9.77	XRC8002VS-50-EPR	XR TIP CAP W/ STR	13.69
XRC110025-VP	TEEJET TIP/CAP XR	5.60	XRC8002VS-50-VI	XR TIP CAP W/ STR	16.07
XRC110025-VS	TEEJET TIP/CAP XR	11.99	XRC8003-VK	TEEJET TIP/CAP XR	9.77
XRC110025VK-50-EPR	XR TIP CAP W/ STR	11.54	XRC8003-VS	TEEJET TIP/CAP XR	11.99
XRC110025VK-50-VI	XR TIP CAP W/ STR	13.91	XRC8003VK-50-EPR	XR TIP CAP W/ STR	11.54
XRC110025VP-50-EPR	XR TIP CAP W/ STR	7.34	XRC8003VK-50-VI	XR TIP CAP W/ STR	13.91
XRC110025VP-50-VI	XR TIP CAP W/ STR	9.70	XRC8003VS-50-EPR	XR TIP CAP W/ STR	13.69
XRC110025VS-50-EPR	XR TIP CAP W/ STR	13.69	XRC8003VS-50-VI	XR TIP CAP W/ STR	16.07
XRC110025VS-50-VI	XR TIP CAP W/ STR	16.07	XRC8004-VK	TEEJET TIP/CAP XR	9.77
XRC11002VK-50-EPR	XR TIP CAP W/ STR	11.54	XRC8004-VS	TEEJET TIP/CAP XR	11.99
XRC11002VK-50-VI	XR TIP CAP W/ STR	13.91	XRC8004VK-50-EPR	XR TIP CAP W/ STR	11.54
XRC11003-VK	TEEJET TIP/CAP XR	9.77	XRC8004VK-50-VI	XR TIP CAP W/ STR	13.91
XRC11003-VP	TEEJET TIP/CAP XR	5.60	XRC8004VS-50-EPR	XR TIP CAP W/ STR	13.69
XRC11003-VS	TEEJET TIP/CAP XR	11.99	XRC8004VS-50-VI	XR TIP CAP W/ STR	16.07
XRC11003VK-50-EPR	XR TIP CAP W/ STR	11.54	XRC8005-VK	TEEJET TIP/CAP XR	9.77
XRC11003VK-50-VI	XR TIP CAP W/ STR	13.91	XRC8005-VS	TEEJET TIP/CAP XR	11.99
XRC11003VP-50-EPR	XR TIP CAP W/ STR	7.34	XRC8005VK-50-EPR	XR TIP CAP W/ STR	11.54
XRC11003VP-50-VI	XR TIP CAP W/ STR	9.70	XRC8005VK-50-VI	XR TIP CAP W/ STR	13.91
XRC11003VS-50-EPR	XR TIP CAP W/ STR	13.69	XRC8005VS-50-EPR	XR TIP CAP W/ STR	13.69
XRC11003VS-50-VI	XR IP CAP W/ STR	16.07	XRC8005VS-50-VI	XR TIP CAP W/ STR	16.07
XRC11004-VK	TEEJET TIP/CAP XR	9.77	XRC8006-VK	TEEJET TIP/CAP XR	9.77
XRC11004-VP	TEEJET TIP/CAP XR	5.60	XRC8006-VS	TEEJET TIP/CAP XR	11.99
XRC11004-VS	TEEJET TIP/CAP XR	11.99	XRC8006VK-50-EPR	XR TIP CAP W/ STR	11.54
XRC11004VK-50-EPR	XR TIP CAP W/ STR	11.54	XRC8006VK-50-VI	XR TIP CAP W/ STR	13.91
XRC11004VK-50-VI	XR TIP CAP W/ STR	13.91	XRC8006VS-50-EPR	XR TIP CAP W/ STR	13.69
XRC11004VP-50-EPR	XR TIP CAP W/ STR	7.34	XRC8006VS-50-VI	XR TIP CAP W/ STR	16.07
XRC11004VP-50-VI	XR TIP CAP W/ STR	9.70	XRC8008-VK	TEEJET TIP/CAP XR	9.77
XRC11004VS-50-EPR	XR TIP CAP W/ STR	13.69	XRC8008VK-50-EPR	XR TIP CAP W/ STR	11.54
XRC11004VS-50-VI	XR TIP CAP W/ STR	16.07	XRC8008VK-50-VI	XR TIP CAP W/ STR	13.91
XRC11005-VK	TEEJET TIP/CAP XR	9.77	Y33180-PP	TANK MIX.EDUCTOR NOZ 3/8"BLACK	92.18
XRC11005-VP	TEEJET TIP/CAP XR	5.60	Y9270-PP	TANK MIX.EDUCTOR NOZ 3/4",BLACK	92.18
XRC11005-VS	TEEJET TIP/CAP XR	11.99			
XRC11005VK-50-EPR	XR TIP CAP W/ STR	11.54			
XRC11005VK-50-VI	XR TIP CAP W/ STR	13.91			
XRC11005VP-50-EPR	XR TIP CAP W/ STR	7.34			
XRC11005VP-50-VI	XR TIP CAP W/ STR	9.70			
XRC11005VS-50-EPR	XR TIP CAP W/ STR	13.69			
XRC11005VS-50-VI	XR TIP CAP W/ STR	16.07			
XRC11006-VK	TEEJET TIP/CAP XR	9.77			
XRC11006-VP	TEEJET TIP/CAP XR	5.60			
XRC11006-VS	TEEJET TIP/CAP XR	11.99			
XRC11006VK-50-EPR	XR TIP CAP W/ STR	11.54			
XRC11006VK-50-VI	XR TIP CAP W/ STR	13.91			
XRC11006VP-50-EPR	XR TIP CAP W/ STR	7.34			
XRC11006VP-50-VI	XR TIP CAP W/ STR	9.70			
XRC11006VS-50-EPR	XR TIP CAP W/ STR	13.69			
XRC11006VS-50-VI	XR TIP CAP W/ STR	16.07			
XRC11008-VK	TEEJET TIP/CAP XR	9.77			
XRC11008-VP	TEEJET TIP/CAP XR	5.60			
XRC11008-VS	TEEJET TIP/CAP XR	11.99			
XRC11008VK-50-EPR	XR TIP CAP W/ STR	11.54			
XRC11008VK-50-VI	XR TIP CAP W/ STR	13.91			
XRC11010-VP	TEEJET TIP/CAP XR	5.60			
XRC11010-VS	TEEJET TIP/CAP XR	11.99			
XRC11015-VP	TEEJET TIP/CAP XR	5.60			
XRC11015-VS	TEEJET TIP/CAP XR	11.99			
XRC11020-VP	TEEJET TIP/CAP XR	5.60			
XRC80015-VS	TEEJET TIP/CAP XR	11.99			
XRC80015VS-100-EPR	XR TIP CAP W/ STR	13.69			
XRC80015VS-100-VI	XR TIP CAP W/ STR	16.07			











# TERMS AND CONDITIONS OF SALE

A small percentage of the items shown in this price list may not be produced under an ISO registered system. For further information contact your sales representative.

## (1) MODIFICATION OF TERMS

Seller's acceptance of any order is expressly subject to Buyer's assent to each and all of the terms and conditions set forth below and Buyer's assent to these terms and conditions shall be conclusively presumed from Buyer's receipt of this document without prompt written objection thereto or from Buyer's acceptance of all or any part of goods ordered. No addition to or modification of said terms and conditions shall be binding upon Seller unless specifically agreed to by Seller in writing. If Buyer's purchase order or other correspondence contains terms or conditions contrary to or in addition to the terms and conditions set forth below, acceptance of any order by Seller shall not be construed as assent to such contrary or additional terms and conditions or constitute a waiver by Seller of any of the terms and conditions.

## (2) PRICE

Unless otherwise specified: (a) all prices, quotations, shipments and deliveries by Seller are (i) EXW (Incoterms® 2010) if shipped to the Buyer within the United States, and (2) in all other circumstances DAP Buyer's location (Incoterms® 2010); (b) all base prices together with related extras and deductions, are subject to Seller's price in effect at the time of shipment; and (c) notwithstanding the use of the shipping term DAP and without any effect on the point at which the risk of loss shifts from Seller to Buyer, all transportation, import costs and other related charges are for the account of Buyer, including all increases or decreases in such charges prior to shipment. Payment of said price shall be due at the remittance address shown on the Seller's invoice upon receipt of Seller's invoice unless otherwise specified. Interest will be charged at a rate of 1 to 1 1/2% per month on all balances outstanding more than 30 days after the date of the invoice. Price includes Seller's standard packaging. Special packaging requirements shall be quoted at an additional price.

## (3) UNIFORM COMMERCIAL CODE

THIS IS A CONTRACT FOR THE SALE OF GOODS. SELLER AND BUYER EXPRESSLY AGREE THAT ANY SERVICES PROVIDED PURSUANT TO THIS CONTRACT ARE MERELY INCIDENTAL TO THE SALE OF GOODS, AND AS SUCH, SHALL BE DEEMED GOODS UNDER ARTICLE 2 OF THE UNIFORM COMMERCIAL CODE. SELLER AND BUYER FURTHER AGREE THAT ANY DISPUTES ARISING FROM THIS CONTRACT SHALL BE GOVERNED BY ARTICLE 2 OF THE UNIFORM COMMERCIAL CODE.

## (4) MINIMUM BILLING

Contact your regional office representative for any minimum order requirements.

## (5) WARRANTIES

Seller warrants that its products will conform to and perform in accordance with the products' specifications. Seller warrants that the products do not infringe upon any copyright, patent, or trademark. THE FOREGOING WARRANTIES ARE IN LIEU OF ALL OTHER WARRANTIES, EXPRESSED OR IMPLIED, INCLUDING, BUT NOT LIMITED TO, THOSE CONCERNING MERCHANTABILITY AND FITNESS FOR A PARTICULAR PURPOSE.

## (6) LIMITATION OF REMEDIES

Buyer's remedies under this warranty shall be limited to the replacement, repair, or refund of the purchase price for any defective product at the Seller's option. Products claimed to be defective and for which repair or replacement is desired shall be, if requested by the Seller, returned transportation prepaid to Seller's plant for inspection. Results of ordinary wear and tear, improper operation, or maintenance or use of corrosive or abrasive materials shall not be considered a defect in material or workmanship. Any component

part manufactured by another is not covered by Seller's warranty, but only by such warranty as its manufacturer gives. Because of the difficulty of asserting and measuring damages hereunder, it is agreed that, except for claims for bodily injury, Seller's liability to the Buyer or any third party, for any losses or damages, whether direct or otherwise, arising out of the purchase of product from Seller by Buyer shall not exceed the total amount billed and billable to the Buyer for the product hereunder. IN NO EVENT WILL SELLER BE LIABLE FOR ANY LOSS OF PROFITS OR OTHER SPECIAL OR CONSEQUENTIAL DAMAGES, EVEN IF SELLER HAS BEEN ADVISED OF THE POSSIBILITY OF SUCH DAMAGES.

## (7) QUALITY ASSURANCE

Seller shall have no obligation to ensure that any goods purchased from Seller meet any special Buyer quality assurance specifications and/or other special Buyer requirements unless such specifications and/or other requirements are specifically set forth in Buyer's purchase order and expressly accepted by Seller. In the event that any such goods supplied by Seller in connection therewith, are applied to an end use without the appropriate specification and/or other requirement therefore having been set forth in Buyer's purchase order and expressly accepted by Seller, Buyer shall indemnify and hold Seller harmless against any and all damages or claims for damages made by any person for any injury, fatal or nonfatal, to any person or for any damage to the property of any person incident to or arising out of such application.

## (8) CLAIMS

Claims respecting the condition of goods, compliance with specifications or any other matter affecting goods shipped to Buyer must be made promptly and, unless otherwise agreed to in writing by Seller, in no event later than one (1) year after receipt of the goods by Buyer. In no event shall any goods be returned, reworked or scrapped by Buyer without the express written authorization of Seller.

## (9) DEFAULT IN PAYMENT

If Buyer fails to make payments on any contract between Buyer and Seller in accordance with Seller's terms, Seller, in addition to any other remedies available to it, may at its option, (i) defer further shipments until such payments are made and satisfactory credit arrangements are reestablished or (ii) cancel the unshipped balance of any order.

## (10) TECHNICAL ASSISTANCE

Unless otherwise expressly stated by Seller, (a) any technical advice provided by Seller with respect to the use of goods furnished to Buyer shall be without charge; (b) Buyer shall have sole responsibility for selection and specification of the goods appropriate for the end use of such goods.

## (11) SAFETY PRECAUTIONS

Buyer shall require its employees to use all safety devices, and proper safe operation procedures as set forth in manuals and instruction sheets furnished by Seller. Buyer shall not remove or modify any such device or warning sign. It is the Buyer's responsibility to provide all means that may be necessary to effectively protect all employees from serious bodily injury which otherwise may result from the method of particular use, operation, set up or service of the goods. The operator's or machine manual, ANSI safety standards, OSHA regulations and other sources should be consulted. If Buyer fails to comply with provisions of this paragraph or the applicable standards and regulations aforementioned, and a person is injured as a result thereof, Buyer agrees to indemnify and save Seller harmless from any liability or obligation incurred by Seller.

## (12) CANCELLATION

Orders for goods specifically manufactured for Buyer cannot be canceled or modified by Buyer, and releases cannot be held up by Buyer, after such goods are in process except with the express written consent of Seller and subject to conditions then to be agreed upon which shall include, without limitation, protection of Seller against all loss.

## (13) PATENTS

The Seller shall not be liable for any costs or damages incurred by the Buyer as a result of any suit or proceeding brought against Buyer so far as based on claims (a) that use of any product, or any part thereof furnished hereunder, in combination with products not supplied by the Seller or (b) that a manufacturing or other process utilizing any product, or any part thereof furnished hereunder, constitute knowing and willful infringement of patents or trademarks arising from compliance with Buyer's designs or specifications or instructions.

## (14) COMPLETE AGREEMENT

THIS CONTRACT SETS FORTH THE ENTIRE AGREEMENT AND UNDERSTANDING OF THE PARTIES RELATING TO THE SUBJECT MATTER HEREOF, AND SUPERSEDES ALL PRIOR AGREEMENTS, DISCUSSIONS AND UNDERSTANDINGS BETWEEN THEM WHETHER ORAL OR WRITTEN, RELATING TO THE SUBJECT MATTER HEREOF.

## (15) GOVERNING LAW

All orders are accepted by Seller at its mailing address in Wheaton, Illinois, and shall be governed by and interpreted in accordance with the laws of the State of Illinois. The United Nations Convention on Contracts for the International Sale of Goods of April 11, 1980 shall be excluded.

## (16) FORCE MAJEURE

Neither party shall be in default of its obligations to the other party for any period of Force Majeure. "Force Majeure" shall mean any delay or failure of a party to perform its obligations to the other party due to causes beyond its control and without its fault or negligence. This shall include, without limitation, Acts of God, strike, civil commotion, acts of government, and any other comparable, non-foreseeable, and a serious event.

## (17) CONFIDENTIAL INFORMATION

Buyer shall maintain Confidential Information in confidence using the same care as used for its own Confidential Information. Buyer shall not disclose or divulge any Confidential Information received by it from Seller in connection with any products or services supplied by Seller to Buyer or to a third party without prior written consent of Seller, and Buyer may not use any Confidential Information for any purpose other than for the manufacture, sale and maintenance of Buyer's products. For the purposes hereof, "Confidential Information" includes any and all information and data, including, but not limited to, any business, commercial, intellectual property, technical information and data disclosed by Seller to Buyer in connection with the sale of Seller's products to Buyer, or relating to Seller's business relationship or the definition, development, marketing, selling, manufacture or distribution of Seller's products, whether disclosed orally, in writing or electronically, and irrespective of the medium in which such information or data is embedded, whether in tangible form or contained in an intangible storage medium. Confidential Information shall include any copies or abstracts made thereof, as well as any product, apparatus, modules, samples, prototypes or parts thereof.



**Wheaton Facility**

North Ave and Schmale Rd  
P.O. Box 7900  
Wheaton, Illinois  
60187-7901 USA

**Springfield Facility**

1801 Business Park Drive  
Springfield, Illinois  
62703 USA

**Aabybro Facility**

Mølhavevej 2  
DK 9440 Aabybro  
Denmark

**[www.teejet.com](http://www.teejet.com)**