

VALLEY
INDUSTRIES

2024
PRODUCT
CATALOG



YOUR SOURCE

FOR AGRICULTURAL & INDUSTRIAL COMPONENTS



www.Valleyind.com
Toll Free 1.800.864.1649
Sales@ValleyInd.com

TABLE OF CONTENTS

FLUID COMPONENTS

Pressure Gauges
Stainless & Brass Fittings
Poly & Nylon Fittings
Stainless & Poly Ball Valves
Strainers & More...

6

SPRAYER ACCESSORIES

Sprayer Frames & Boom Kits
Spray Nozzles for Booms
Boomless Spray Nozzles
Everflo Diaphragm Pumps
Spot Spray Guns & More...

42

AGRICULTURAL PARTS

Hitch, Clevis, & Implement Pins
PTO Adapters
Stabilizer Arms
Stroke Control Segments
Securing Pins & More...

70

AUTOMOTIVE

Top & Side Wind Trailer Jacks
Heavy Duty Trailer Jacks
Trailer Winches
RV Pumps & Fittings
Jack Accessories & More...

78

PRESSURE WASHING & SOFT WASH

Water Brooms & Surface Cleaners
Spray Guns, Lances, Hoses, & Kits
QC, MEG, & Rotary Nozzles
Soft Wash Pumps & Units
Accessories & More...

84

POWER EQUIPMENT

Disinfectant Sprayer
Pressure Washers
Water Pumps
Trash Pumps
Power Generators

104

ABOUT US

Valley Industries, initially established as a distributor of pressure gauges and accessories, has undergone a transformative evolution, solidifying its position as a pioneering force within the agricultural, industrial, and retail sectors. Presently, Valley Industries stands as a prominent manufacturer and distributor, offering an expansive array of thousands of products across multiple categories and renowned brands, all recognized for their unwavering commitment to superior performance and quality standards.

CONTACT US TODAY

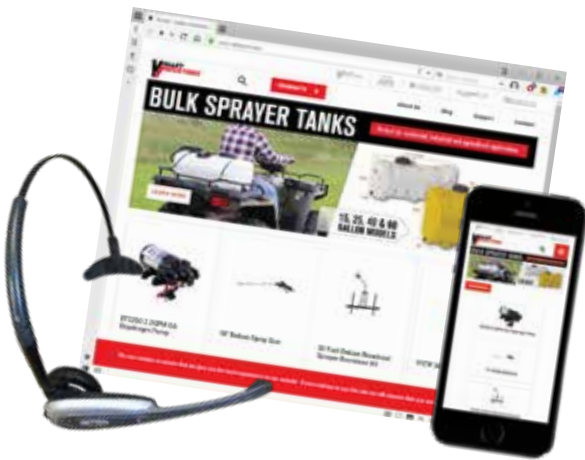

ORDERING

Phone:	800-864-1649
Fax:	888-708-1895
Email:	sales@valleyind.com

CUSTOMER SUPPORT

Phone:	800-825-5397
Email:	info@valleyind.com

OUR BRANDS



Agricultural Sprayers, Accessories & Components.
www.master-mfg.com



Diaphragm and High Pressure Plunger Pumps & Accessories.
www.cometpump.com



12 Volt DC Diaphragm Pumps & Accessories.
www.everflopump.com



Agricultural Mist Sprayers & Accessories.
www.mistsprayers.com



Professional Ag Sprayers, Attachments, & Accessories.
www.bestwayag.com

VALLEY INDUSTRIES ADVANTAGE

At Valley Industries, we are dedicated to exceeding our customers' expectations and consistently delivering quality products that precisely match their requirements. Our commitment to exceptional customer service is reflected in the meticulous engineering, assembly, and sourcing processes we employ, which incorporate top-notch components, all while ensuring competitive pricing for our valued customers.

ENGINEERING & MANUFACTURING



The Valley Industries team is continuously engaged in innovation, crafting fresh concepts and ideas that consistently deliver the expected quality and performance in every product.

CENTRALIZED LOCATION

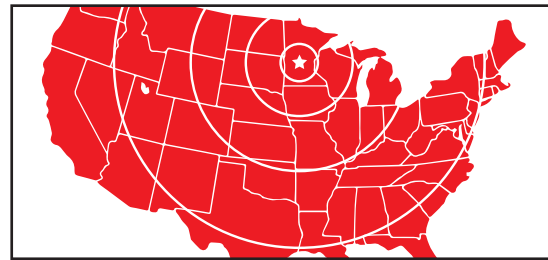

All of our facilities are based in Paynesville, MN, providing a quick turn-around on your orders.

BUNDLE UP



Save time, money, and resources by bundling with Valley Industries. With just one purchase order, bundle products from all available brands and categories.

360° CUSTOMER SERVICE



Valley Industries provides 360-degree visibility to all customers, big or small. Through trouble-shooting guides or an informed sales staff, effortlessly receive solutions to your problems.

MERCHANDISING

At Valley Industries, we're not content with the status quo. We have reimagined the way products are presented, packaged, and displayed, introducing innovative solutions that breathe new life into the retail experience. From our eye-catching packaging designs to strategic point-of-purchase placements and customizable pre-set planograms, we are committed to transforming the way products are showcased and sold, creating engaging and efficient retail environments that captivate customers and drive sales.

POINT OF PURCHASE



Our innovative point-of-purchase displays captivate shoppers, making their retail experience more engaging and convenient while driving increased sales and brand recognition.

PRE-SET PLANOGRAMS



Valley Industries' pre-set planograms prioritize high-velocity products, ensuring they follow a logical and visually appealing flow for an optimized shopping experience.

PACKAGING



Valley Industries' packaging goes beyond protection; it's designed to engage and inform customers, assisting them in making confident and informed purchasing choices.



RETAIL READY CLAMSHELL PACKAGING

VALLEY INDUSTRIES offers the option of high quality clamshell retail display packaging on select gauges.

Contact us for minimum quantities and availability!

Since 1998, Valley Industries has been a leading pressure gauge supplier world-wide. Today, we manufacture and distribute a wide range of industrial and agricultural products across several brands. Even with our expanded product offerings, we continue to keep focus on being the #1 pressure gauge source to our customers!

PRESSURE GAUGES CUSTOM LOGOS & DIALS

Use your company logo, trademarks and color schemes to tie your gauge to your brand or style.

Custom Gauge Faces

The highest level of customization from identification zones, numbering, scale colors and more to fit your needs.



Small Order Size

Minimum order quantity of only 100 pieces allows you to customize your gauges without forcing you to hold huge numbers in stock. No additional charge for artwork!

Short Lead Times

We provide digital files for your approval before going into production. Gauges are typically finished with 90-120 days from placement of your order.

Flexible Terms

A variety of payment terms are available to meet your needs. Talk to your sales representative today for more information.

PRESSURE GAUGES

SINGLE & DUAL SCALE 10 SERIES GEARLESS

Movement	None
Bourdon Tube	Copper alloy, spiral wound, gearless
Pointer	Brass
Dial	White aluminum
Window	Acrylic
Fill Material	Dry only
Connection Size	1/8" MNPT
Accuracy	ASME/ANSI B40.1 Grade D (±5%)

1, 1 1/4" Casing. Center Back Mount only. These gauges are designed for use on compressors, mini regulators and pneumatic applications where space is at a premium.



ORDERING INFORMATION

Part #	PSI Range
23MM0010DCB60	0 - 60
23MM0010DCB100	0 - 100
23MM0010DCB160	0 - 160

ORDERING INFORMATION

Non-Stock
Please Call for pricing and ordering information.

Movement	Brass
Bourdon Tube	C-Shaped in copper alloy up to 600 PSI and Helical in phosphor bronze above 600 PSI
Pointer	Black enameled aluminum
Dial	White aluminum
Window	Acrylic
Case Material	Steel, black painted
Bezel	Chrome plated
Connection Material	Brass
Connection Size	1/8" MNPT on 1 1/2" size. 1/4" MNPT on 2", 2 1/2" and 4" sizes.
Accuracy	ASME/ANSI B40.1 Grade B (3-2-3%)
Fill Material	Dry only
Wetted Parts	Copper alloy

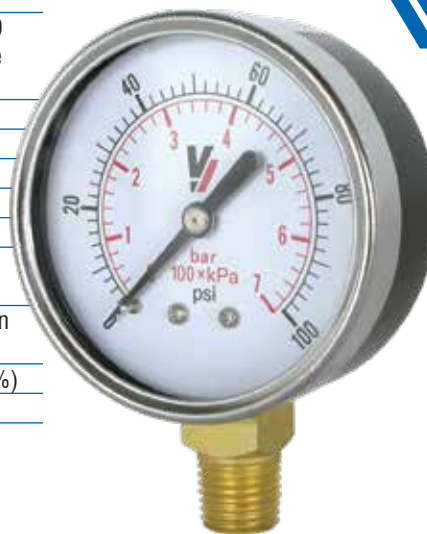

DUAL SCALE 20 SERIES GENERAL SERVICE

1 1/2", 2", 2 1/2", and 4" Casing
Center Back and Bottom Mount Only.

These gauges are designed for use with gas, oil, and water or any medium not corrosive to brass or bronze.

Temp Rating -40° F to 150° F

ORDERING INFORMATION

1 st Digit	2 nd Digit	3 rd , 4 th Digit	5 th Digit	6 th Digit	7 th Digit	Range	Suffix
Dial Size	Case Style	Model #	Fill Material	Case Material	Wetted Parts	PSI/bar/Vacuum	Options
0 = 1 1/2"	1 = Bottom	20	D = Dry	S=Steel	B = Brass	Up to 1000 PSI	Custom Logo
1 = 2"	2 = Back					Up to 70 bar	Color Dial
2 = 2 1/2"						Vacuum Available	Special Dial
4 = 4"							Etc..

1120DSB200 = 2" Bottom Mount, Model 20, Dry, Steel Case, 200 PSI

PRESSURE

SINGLE SCALE 24 SERIES GENERAL SERVICE

2", 2½", and 4" Casing
Bottom Mount Only.

These gauges are designed for use with gas, oil, and water or any medium not corrosive to brass or bronze.

Temp Rating -40° F to 150° F (Dry)



Movement	Brass
Bourdon Tube	C-Shaped in copper alloy up to 600 PSI and Helical in phosphor bronze above 600 PSI
Pointer	Black enameled aluminum
Dial	White aluminum
Window	Acrylic
Case Material	ABS standard, black steel optional
Bezel	Black
Connection Material	Brass
Connection Size	¼" MNPT
Accuracy	ASME/ANSI B40.1 Grade B (3-2-3%)
Fill Material	Dry only
Wetted Parts	Copper alloy

ORDERING INFORMATION

1 st Digit	2 nd Digit	3 rd , 4 th Digit	5 th Digit	6 th Digit	7 th Digit	Range	Suffix
Dial Size	Case Style	Model #	Fill Material	Case Material	Wetted Parts	PSI	Options
0 = 1½"	1 = Bottom	24	D = Dry	A = ABS	B = Brass	Up to 600 PSI	Custom Logo
1 = 2"				S = Black Steel*			Color Dial
2 = 2½"							Special Dial
4 = 4"							Etc.

1124DSB200 = 2" Bottom Mount, Model 24, Dry, Steel Case, 200 PSI *Special Order.

Movement	Brass
Bourdon Tube	C-Shaped in copper alloy up to 600 PSI and Helical in phosphor bronze above 600 PSI
Pointer	Black enameled aluminum
Dial	White aluminum
Window	Polycarbonate
Case Material	Steel, corrosion resistant black
Bezel	Stainless Steel Rolled
Connection Material	Brass
Connection Size	½" MNPT on 1½" size. ¼" MNPT on 2" and 2½" sizes.
Accuracy	ASME/ANSI B40.1 Grade A (2-1-2%)
Fill Material	Dry only
Wetted Parts	Copper alloy



DUAL SCALE 30 SERIES UTILITY

1½", 2", and 2½" Casing
Center Back, Bottom, Front,
or Panel Mount.

These gauges are designed for use with gas, oil, and water or any medium not corrosive to brass or bronze.

Temp Rating -40° F to 150° F (Dry)

ORDERING INFORMATION

1 st Digit	2 nd Digit	3 rd , 4 th Digit	5 th Digit	6 th Digit	7 th Digit	Range	Suffix
Dial Size	Case Style	Model #	Fill Material	Case Material	Wetted Parts	PSI/bar/Vacuum	Options
0 = 1½"	1 = Bottom	30	D = Dry	S = Black Steel	B = Brass	Up to 6000 PSI	Custom Logo
1 = 2"	2 = Back					Up to 400 bar	Color Dial
2 = 2½"	3 = Front					Vacuum Available	Special Dial
	4 = Panel						Etc.

1130DSB200 = 2" Bottom Mount, Model 30, Dry, Steel Case, 200 PSI

GAUGES



Movement	Brass
Bourdon Tube	C-Shaped in copper alloy up to 600 PSI and Helical in phosphor bronze above 600 PSI
Pointer	Black enameled aluminum
Dial	White aluminum
Window	Polycarbonate - temperature compensating
Case Material	304 Stainless steel
Connection Material	Brass
Connection Size	1/8" MNPT on 1 1/2" size. 1/4" MNPT on 2", 2 1/2" and 4" sizes.
Accuracy	ASME/ANSI B40.1 Grade A (2-1-2%)
Fill Material	Dry, Glycerin, Silicone
Wetted Parts	Copper alloy



DUAL SCALE 40 SERIES INDUSTRIAL

1 1/2", 2", 2 1/2", and 4" Casing
Center Back, Bottom, Front, or Panel Mount.

These gauges are designed for use with any medium not corrosive to brass or bronze.

Temp Rating	-50° F to 150° F (Silicone) -40° F to 150° F (Dry) 32° F to 150° F (Glycerin)
--------------------	---

ORDERING INFORMATION							
1 st Digit	2 nd Digit	3 rd , 4 th Digit	5 th Digit	6 th Digit	7 th Digit	Range	Suffix
Dial Size	Case Style	Model #	Fill Material	Case Material	Wetted Parts	PSI/bar/Vacuum	Options
0 = 1 1/2"	1 = Bottom	40	D = Dry*	X=Stainless	B = Brass	Up to 10000 PSI	Custom Logo
1 = 2"	2 = Back		G = Glycerin			Up to 700 bar	Color Dial
2 = 2 1/2"	3 = Front		S = Silicone*			Vacuum Available	Special Dial
4 = 4"	4 = Panel						Etc.
1140GXB200 = 2" Bottom Mount, Model 40, Glycerin Filled, Stainless Steel Case, 200 PSI						*Special Order.	

SINGLE SCALE 41 SERIES OEM

2 1/2" and 4" Casing
Center Back, Bottom, Front, or Panel Mount.

These gauges are designed for use with any medium not corrosive to brass or bronze.



Movement	Brass
Bourdon Tube	C-Shaped in copper alloy up to 1000 PSI and Helical in phosphor bronze above 1000 PSI
Pointer	Black enameled aluminum
Dial	White aluminum
Window	Acrylic
Case Material	304 Stainless steel
Connection Material	Brass
Connection Size	1/4" MNPT
Accuracy	ASME/ANSI B40.1 Grade B (3-2-3%)
Fill Material	Dry, Glycerin
Wetted Parts	Copper alloy

Temp Rating	-40° F to 150° F (Dry) 32° F to 150° F (Glycerin)
--------------------	--

ORDERING INFORMATION							
1 st Digit	2 nd Digit	3 rd , 4 th Digit	5 th Digit	6 th Digit	7 th Digit	Range	Suffix
Dial Size	Case Style	Model #	Fill Material	Case Material	Wetted Parts	PSI/Vacuum	Options
2 = 2 1/2"	1 = Bottom	41	D = Dry*	X=Stainless	B = Brass	Up to 10000 PSI	Custom Logo
	2 = Back*		G = Glycerin			Vacuum Available	Color Dial
	3 = Front*						Special Dial
	4 = Panel*						Etc.
2141GXB200 = 2" Bottom Mount, Model 41, Glycerin Filled, Stainless Steel Case, 200 PSI						*Special Order.	

PRESSURE

SINGLE SCALE 54 SERIES STAINLESS OEM

2½" and 4" Casing
Center Back, Bottom, Front, or Panel
Mount.

These gauges are designed for use with any medium not corrosive to stainless steel.

Temp Rating -50° F to 150° F (Silicone)
-40° F to 150° F (Dry)
32° F to 150° F (Glycerin)



Movement	Stainless steel
Bourdon Tube	316 Stainless steel
Pointer	Black enameled aluminum
Dial	White aluminum
Window	Polycarbonate
Case Material	304 Stainless steel
Connection Material	304 Stainless steel
Connection Size	¼" MNPT
Accuracy	ASME/ANSI B40.1 Grade B (3-2-3%)
Fill Material	Dry, Glycerin, Silicone, Florolube
Wetted Parts	Stainless steel

ORDERING INFORMATION

1 st Digit	2 nd Digit	3 rd , 4 th Digit	5 th Digit	6 th Digit	7 th Digit	Range	Suffix
Dial Size	Case Style	Model #	Fill Material	Case Material	Wetted Parts	PSI/Vacuum	Options
2 = 2½"	1 = Bottom	54	D = Dry*	X=Stainless	X=Stainless	Up to 10000 PSI	Custom Logo
4 = 4"	2 = Back*		G = Glycerin			Vacuum Available	Color Dial
	3 = Front*		S = Silicone*				Special Dial
	4 = Panel*		F = Florolube*				Etc.
2154DXX200 = 2" Bottom Mount, Model 54, Dry, Stainless Steel Case, 200 PSI						*Special Order.	

Movement	Stainless steel
Bourdon Tube	316 Stainless steel
Pointer	Black enameled aluminum
Dial	White aluminum
Window	Polycarbonate
Case Material	304 Stainless steel
Bezel	Stainless steel, Bayonet type
Connection Material	316 Stainless steel
Connection Size	½" MNPT
Accuracy	ASME/ANSI B40.1 Grade 1A (1%)
Fill Material	Dry, Glycerin, Silicone
Wetted Parts	Stainless steel



SINGLE SCALE 58 SERIES STAINLESS REPAIRABLE

4" Casing
Bottom Mount Only.

These gauges are designed for use with any medium not corrosive to stainless steel. Liquid-filled gauges are recommended for reducing shock caused by pressure fluctuations or vibration.

Temp Rating -50° F to 150° F (Silicone)
-40° F to 150° F (Dry)
32° F to 150° F (Glycerin)

ORDERING INFORMATION

1 st Digit	2 nd Digit	3 rd , 4 th Digit	5 th Digit	6 th Digit	7 th Digit	Range	Suffix
Dial Size	Case Style	Model #	Fill Material	Case Material	Wetted Parts	PSI/Vacuum	Options
4 = 4"	1 = Bottom	58	D = Dry*	X=Stainless	X=Stainless	Up to 15000 PSI	Custom Logo
			G = Glycerin			Vacuum Available	Color Dial
			S = Silicone*				Special Dial
4158DXX200 = 4" Bottom Mount, Model 58, Stainless Dry, Steel Case, 200 PSI						*Special Order.	

GAUGES

SINGLE SCALE 60 SERIES LOW PRESSURE

Movement	Brass
Diaphragm	Sensitive phosphor bronze
Pointer	Black enameled aluminum
Dial	White aluminum
Window	Acrylic
Case Material	Steel, black painted
Connection Material	Brass
Connection Size	1/4" MNPT
Accuracy	ASME/ANSI B40.1 Grade A (2-1-2%)
Fill Material	Dry only
Wetted Parts	Copper alloy



2 1/2" and 4" Casing
Bottom Mount Only.

These gauges are designed for use with any medium not corrosive to bronze or brass and pressures up to 10 psi.

Temp Rating -40° F to 150° F

ORDERING INFORMATION

1 st Digit	2 nd Digit	3 rd , 4 th Digit	5 th Digit	6 th Digit	7 th Digit	Range	Suffix
Dial Size	Case Style	Model #	Fill Material	Case Material	Wetted Parts	Inches of Water/PSI	Options
2 = 2 1/2"	1 = Bottom	60	D = Dry	S=Steel	B = Brass	Up to 200 IOW Up to 10 PSI	Custom Logo Color Dial Special Dial Etc.

4160DSB015 = 4" Bottom Mount, Model 60, Dry, Steel Case, 15 PSI

*Special Order.

SINGLE SCALE 80 SERIES AMMONIA

2 1/2" and 4" Casing
Bottom Mount Only.

This rugged product employs a 316 stainless steel bourdon tube, ASME grade A movement, and a stainless steel socket all housed in a corrosive resistant painted steel case. This gauge is of the highest quality and is very competitively priced. In addition we will include your name and logo on the dial free of charge with a minimum order of 250 pieces per range. Also available with glass lense.

Temp Rating -40° F to 150° F



Movement	304 Stainless steel
Bourdon Tube	316 Stainless steel
Pointer	Black enameled aluminum
Dial	White aluminum
Window	Acrylic
Case Material	Enameled steel
Connection Material	304 Stainless steel
Connection Size	1/4" MNPT
Accuracy	ASME/ANSI B40.1 Grade A (2-1-2%)
Fill Material	Dry only
Wetted Parts	Stainless steel

ORDERING INFORMATION

1 st Digit	2 nd Digit	3 rd , 4 th Digit	5 th Digit	6 th Digit	7 th Digit	Range	Suffix
Dial Size	Case Style	Model #	Fill Material	Case Material	Wetted Parts	PSI/Vacuum	Options
2 = 2 1/2"	1 = Bottom	80	D = Dry	S=Steel	X=Stainless	Up to 400 PSI Vacuum Available	Custom Logo Color Dial Special Dial Etc.

4180DSX160 = 4" Bottom Mount, Model 80, Dry, Steel Case, 160 PSI

*Special Order.

INDICATOR

GAUGE EDGE



FEATURES

Movement	Gearless
Bourbon Tube	C-Shaped copper alloy
Pointer	Red plastic
Dial	White plastic
Window	Acrylic
Case Material	Plastic
Connection Material	Brass
Connection Size	10-32 Female thread
Accuracy	ASME/ANSI B40.1 Grade D (±5%)
PSI & bar.	Ranges 60PSI & 100 PSI

½" x 2½" Case

Ideally suited for low-profile panels where space is at a premium. Designed for use with air, gas, light oil, water and any medium not corrosive to brass or bronze.

Part#	PSI Range
00EDGE60	0 - 60

GAUGES INDICATOR



1HA7353



1K528E

Part #	Size	Description
1HA7353	2"	Ammeter Gauge, Oliver Logo
1K528E	2"	Temperature Gauge, Oliver Logo, 52" Cap. Tube

GAUGE TEMPERATURE



Part #	Size
C3NN18287A-P	2"

Includes Bracket & Farrel

GAUGE OIL PRESSURE

Center Back Mount Only.



Part #	Size	PSI	Connection Size
70207834	2"	0-30	1/8" MNPT

GAUGES

GAUGE OIL PRESSURE



Center Back Mount Only.

Part #	Size	PSI	Connection Size
9N9273A	2"	0-50	1/8" MNPT

GAUGE OIL PRESSURE



Center Back Mount Only.

Part #	Size	PSI	Connection Size
FAD9273A	2"	0-80	1/8" MNPT

GAUGE AMPERES



Part #	Size	Range
A0NN10670A	2"	30-0-30

GAUGE AMPERES



Part #	Size	Range
70275840	2"	20-0-20

GAUGE TEMPERATURE



Part #	Size	Range
UTG25	2"	130°-280° F

Includes 70" Capillary Line

GAUGE VOLTMETER

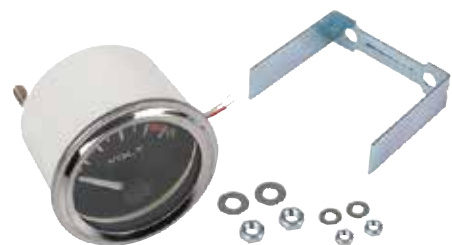

Part #	Size	Range
VOLT12LT	2"	8-16V

PRESSURE GAUGE ACCESSORIES

PROTECTIVE COVERS



Part #	Size	Color
20RC-BLK	2"	Black
25RC-BLK	2 1/2"	Black
25RC-BL	2 1/2"	Blue

FRONT FLANGES



Part #	Size	Gauge Series
0330/40-FF	1 1/2"	30 / 40 / 41
1330/40-FF	2"	30 / 40 / 41
2330/40-FF	2 1/2"	30 / 40 / 41
4330/40-FF	4"	30 / 40 / 41

Push on Front Flange for panel mount gauge

ANSI STANDARD RINGS



Part #	Size
ANSI RING-20	2"
ANSI RING-25	2 1/2"

Oversize polished stainless steel rings designed to allow DIN standard gauges to fit into ANSI standard panel cutouts.

U CLAMPS



Part #	Size	Gauge Series
2440-UC	2 1/2"	40 / 41
2454-UC	2 1/2"	54
4440-UC	4"	40

No case studs required. Clamp attaches to groove in connection. Rings can be rotated 360°.

CLAMP RINGS



Part #	Size	Gauge Series
0430/40-CR	1 1/2"	30 / 40 / 41
1430/40-CR	2"	30 / 40 / 41
2440-CR	2 1/2"	30 / 40 / 41

Totally circular rings with two eccentric screws on each side to fully hold the pressure gauge into a panel. Rings can be rotated 360°.

ADAPTERS



Part #	Fitting Style	Connection Size
AB-1418	Reducer	1/4" FNPT x 1/8" MNPT
AB-1412-HE	Adapter	1/4" FNPT x 1/2" MNPT

THREADED LENSES



Part #	Size	Gauge Series
AF-212	2 1/2"	80

Screw-on cover made of polycarbonate.

GAUGE DAMPENER

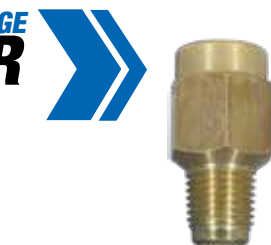

Part #	Connection Size
GD-14	1/4" FNPT x 1/4" MNPT

Snubber that protects from pressure surges.

NYLON & POLYPROPYLENE FITTINGS



Our nylon fittings are made from high quality type 6 virgin resin. Nylon fittings are generally acceptable for use at working pressures up to 150 PSI at normal room temperatures. At very low pressures, temperatures can approach 175° F with no degradation.

Our polypropylene fittings are made 10% glass polypropylene resin. Polypropylene fittings are generally acceptable for use at working pressures up to 150 PSI at ambient temperatures. As with all thermoplastics, an increase in working temperature is accompanied by a decrease in operating pressure.



RETAIL READY CLAMSHELL PACKAGING

VALLEY INDUSTRIES offers the option of high quality clamshell retail display packaging on select fittings.

Contact us for minimum quantities and availability!

NYLON

RECOMMENDED USAGE	NOT RECOMMENDED
Ammonium Compounds	Acids or Acid Based Fertilizers
Detergents	Bromine
Diesel, Ethanol or Gasoline	Chlorine
Magnesium Sulfate	Fluorine
Sodium Compounds	Iodine
Trichloroethylene	Xylene Based Chemicals
Zinc Sulphate	Extreme UV Exposure
High Structural or Physical Strength	
Sealant Tape	

PHYSICAL PROPERTIES	
Specific Gravity	1.12
Heat Distortion	375° F
Rockwell Hardness (R)	120
Izod Impact	1.0 ft. - lbs./in
Temp Range	0° - 200° F

POLY

RECOMMENDED USAGE	NOT RECOMMENDED
Acids or Acid Based Fertilizers	Aromatic Hydrocarbons
Ammonium Compounds	Carbon Tetrachloride
Calcium Carbonate	Gasoline or Kerosene
Ethanol	Nitric Acid
Magnesium Sulfate	Sodium Hypochlorate
Sodium Compounds	Toluene or Xylene Based Chemicals
Extreme UV Exposure	Impact Wrenches or Overtightening
	Sealant Tape

PHYSICAL PROPERTIES	
Specific Gravity	0.98
Heat Distortion	285° F
Rockwell Hardness (R)	100
Izod Impact	0.8 ft. - lbs./in
Temp Range	32° - 150° F

ABBREVIATIONS

MPS Male Pipe Straight	FPS Female Pipe Straight	MNPT Male National Pipe Thread	FNPT Female National Pipe Thread
HB Hose Barb	MGHT Male Garden Hose Thread	FGHT Female Garden Hose Thread	FBSP Female British Straight Pipe

PIPE NYLON &

MNPTxHB HOSE BARBS



Nylon	Poly	Connection Size
A18316^	3A18316^	1/8" x 3/16"
A1814**	3A1814	1/8" x 1/4"
A18516^	3A18516^	1/8" x 5/16"
A1838	3A1838	1/8" x 3/8"
A14316	3A14316^	1/4" x 3/16"
A14**	3A14	1/4" x 1/4"
A14516^	3A14516^	1/4" x 5/16"
A1438**	3A1438	1/4" x 3/8"
A1412	3A1412	1/4" x 1/2"
A3814	3A3814	3/8" x 1/4"
A38516	3A38516^	3/8" x 5/16"
A38**	3A38	3/8" x 3/8"
A3812**	3A3812	3/8" x 1/2"
A3858**	3A3858	3/8" x 5/8"
A1214**	3A1214	1/2" x 1/4"
A1238**	3A1238	1/2" x 3/8"
A12**	3A12	1/2" x 1/2"
A1258**	3A1258	1/2" x 5/8"
A1234**	3A1234	1/2" x 3/4"
A3414	3A3414^	3/4" x 1/4"
A3438	3A3438	3/4" x 3/8"
A3412	3A3412	3/4" x 1/2"
A3458	3A3458	3/4" x 5/8"
A34	3A34	3/4" x 3/4"
A34100**	3A34100	3/4" x 1"
A10034**	3A10034	1" x 3/4"
A100**	3A100	1" x 1"
A100114	3A100114	1" x 1 1/4"
A11434	3A11434	1 1/4" x 3/4"
A114100	3A114100	1 1/4" x 1"
A114	3A114	1 1/4" x 1 1/4"
A114112	3A114112	1 1/4" x 1 1/2"
A112114	3A112114	1 1/2" x 1 1/4"
A112 •	3A112	1 1/2" x 1 1/2"
A200 •	3A200	2" x 2"

MNPTxHB ELBOWS



Nylon	Poly	Connection Size
EL1814	3EL1814	1/8" x 1/4"
EL1838	3EL1838	1/8" x 3/8"
EL14316	3EL14316	1/4" x 3/16"
EL14	3EL14	1/4" x 1/4"
EL14516^	3EL14516^	1/4" x 5/16"
EL1438	3EL1438	1/4" x 3/8"
EL1412	3EL1412	1/4" x 1/2"
EL3814^	3EL3814	3/8" x 1/4"
EL38516	3EL38516^	3/8" x 5/16"
EL38**	3EL38	3/8" x 3/8"
EL3812**	3EL3812	3/8" x 1/2"
EL3858	3EL3858	3/8" x 5/8"
EL1214	3EL1214	1/2" x 1/4"
EL1238**	3EL1238	1/2" x 3/8"
EL12**	3EL12	1/2" x 1/2"
EL1258**	3EL1258	1/2" x 5/8"
EL1234**	3EL1234	1/2" x 3/4"
EL3414	3EL3414^	3/4" x 1/4"
EL3438**	3EL3438	3/4" x 3/8"
EL3412**	3EL3412	3/4" x 1/2"
EL3458	3EL3458	3/4" x 5/8"
EL34**	3EL34	3/4" x 3/4"
EL34100 •	3EL34100	3/4" x 1"
EL100	3EL100	1" x 1"
EL10012	3EL10012	1" x 1 1/2"
EL10034	3EL10034	1" x 3/4"
EL114	3EL114	1 1/4" x 1 1/4"
EL114100	3EL114100	1 1/4" x 1"
EL112 •	3EL112	1 1/2" x 1 1/2"
EL200	3EL200	2" x 2"

FNPTxHB ELBOWS



Nylon	Poly	Connection Size
EL1814F	3EL1814F^	1/8" x 1/4"
EL1838F^	3EL1838F^	1/8" x 3/8"
EL14316F^	3EL14316F^	1/4" x 3/16"
EL14F	3EL14F	1/4" x 1/4"
EL1438F^	3EL1438F^	1/4" x 3/8"
EL3814F	3EL3814F^	3/8" x 1/4"
EL38F^	3EL38F	3/8" x 3/8"
EL3812F^	3EL3812F	3/8" x 1/2"
EL12F	3EL12F	1/2" x 1/2"
EL1258F	3EL1258F^	1/2" x 5/8"
EL1234F^	3EL1234F	1/2" x 3/4"
EL3412F	3EL3412F	3/4" x 1/2"
EL3458F^	3EL3458F^	3/4" x 5/8"
EL34F	3EL34F	3/4" x 3/4"

**Add -CSK suffix for clamshell retail packaging. • Add BC- prefix for barcoded product. ^Non-stock item, call for availability and pricing.

FITTINGS

POLYPROPYLENE



FNPTxFNPT ELBOWS

Nylon	Poly	Connection Size
N/A	3LL12	1/2" x 1/2"
N/A	3LL34	3/4" x 3/4"
LL100	N/A	1" x 1"
LL114	3LL114	1 1/4" x 1 1/4"
LL112	N/A	1 1/2" x 1 1/2"

FNPTxHB HOSE BARBS

Nylon	Poly	Connection size
A14F	3A14F	1/4" x 1/4"
A1438F	3A1438F	1/4" x 3/8"
A3814F^	3A3814F^	3/8" x 1/4"
A38F	3A38F	3/8" x 3/8"
A3812F^	3A3812F	3/8" x 1/2"
A1214F^	3A1214F	1/2" x 1/4"
A1238F	3A1238F	1/2" x 3/8"
A12F	3A12F	1/2" x 1/2"
A1258F	3A1258F^	1/2" x 5/8"
A1234F^	3A1234F	1/2" x 3/4"
A3438F^	3A3438F^	3/4" x 3/8"
A3412F	3A3412F	3/4" x 1/2"
A3458F^	3A3458F^	3/4" x 5/8"
A34F	3A34F	3/4" x 3/4"

FNPTxMNPT STREET ELBOWS

Nylon	Poly	Connection Size
SE14	3SE14	1/4" x 1/4"
SE38	3SE38	3/8" x 3/8"
SE12	3SE12	1/2" x 1/2"
SE34 •	3SE34	3/4" x 3/4"
SE100	3SE100	1" x 1"
SE112	3SE112	1 1/2" x 1 1/2"
SE200 •	3SE200	2" x 2"

FNPTxMNPT STREET ELBOWS 45°

Nylon	Poly	Connection Size
SE3445	3SE3445	3/4" x 3/4"

FNPTxFNPT TEES

Nylon	Poly	Connection Size
TT14	3TT14	1/4"
TT12	3TT12	1/2"
TT34 •	3TT34	3/4"
TT100	3TT100	1"
TT114	3TT114	1 1/4"
TT112	3TT112	1 1/2"
TT200	3TT200	2"

FNPTxFNPT COUPLINGS

Nylon	Poly	Connection Size
FC12**	3FC12	1/2" x 1/2"
FC34**	3FC34	3/4" x 3/4"
FC38	N/A	3/8" x 3/8"
FC100	3FC100	1" x 1"
FC114	3FC114	1 1/4" x 1 1/4"
FC112	3FC112	1 1/2" x 1 1/2"
FC200 •	3FC200	2" x 2"

**Add -CSK suffix for clamshell retail packaging. • Add BC- prefix for barcoded product. ^Non-stock item, call for availability and pricing.



PIPE

NYLON &

REDUCING NIPPLES MNPTxMNPT



Nylon	Poly	Connection Size
M1418 [^]	3M1418	1/4" x 1/8"
M3818	3M3818 [^]	3/8" x 1/8"
M3814	3M3814	3/8" x 1/4"
M1214	3M1214	1/2" x 1/4"
M1238	3M1238	1/2" x 3/8"
M3438 [^]	3M3438	3/4" x 3/8"
M3412 ^{**}	3M3412	3/4" x 1/2"

MNPTxMNPT NIPPLES



Nylon	Poly	Connection Size
M18 [^]	3M18	1/8" x 1/8"
M14	3M14	1/4" x 1/4"
M38	3M38	3/8" x 3/8"
M12	3M12	1/2" x 1/2"
M34 ^{**}	3M34	3/4" x 3/4"
M100	3M100	1" x 1"
M114	3M114	1 1/4" x 1 1/4"
M112 •	3M112	1 1/2" x 1 1/2"
M200 •	3M200	2" x 2"

REDUCER BUSHINGS MNPTxFNPT

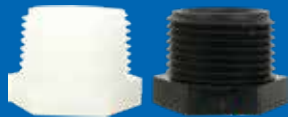

Nylon	Poly	Connection Size
RB3818 [^]	3RB3818	3/8" x 1/8"
RB3814 ^{**}	3RB3814	3/8" x 1/4"
RB1218	3RB1218 [^]	1/2" x 1/8"
RB1214 ^{**}	3RB1214	1/2" x 1/4"
RB1238 ^{**}	3RB1238	1/2" x 3/8"
RB3418 [^]	3RB3418	3/4" x 1/8"
RB3414 ^{**}	3RB3414	3/4" x 1/4"
RB3438	3RB3438	3/4" x 3/8"
RB3412	3RB3412	3/4" x 1/2"
RB10012 ^{**}	3RB10012	1" x 1/2"
RB10034 ^{**}	3RB10034	1" x 3/4"
RB11434 •	3RB11434	1 1/4" x 3/4"
RB114100 •	3RB114100	1 1/4" x 1"
RB11234	N/A	1 1/2" x 3/4"
RB112100 •	3RB112100	1 1/2" x 1"
RB112114 •	3RB112114	1 1/2" x 1 1/4"
RB20034	3RB20034	2" x 3/4"
RB200100	3RB200100	2" x 1"
RB200114 •	3RB200114	2" x 1 1/4"
RB200112 •	3RB200112	2" x 1 1/2"
RB300200	3RB300200	3" x 2"

FNPTxFNPT TEES 1/4" GAUGE PORT



Nylon	Poly	Connection Size
GTT1214	3GTT1214	1/2"
GTT3414	3GTT3414	3/4"

MNPT HEX PLUGS



Nylon	Poly	Connection Size
F18	3F18	1/8"
F14 ^{**}	3F14	1/4"
F38	3F38	3/8"
F12 ^{**}	3F12	1/2"
F34 ^{**}	3F34	3/4"
F100	3F100	1"
F114	3F114	1 1/4"
F112	3F112	1 1/2"
F200	3F200	2"

**Add -CSK suffix for clamshell retail packaging. • Add BC- prefix for barcoded product. [^]Non-stock item, call for availability and pricing.

FITTINGS

POLYPROPYLENE



HEX HOSE MENDERS HBxHB

Nylon	Poly	Connection Size
SHM14**	3SHM14	1/4" x 1/4"
SHM38**	3SHM38	3/8" x 3/8"
SHM1238**	3SHM1238	1/2" x 3/8"
SHM12**	3SHM12	1/2" x 1/2"
SHM1258	3SHM1258	1/2" x 5/8"
SHM58	3SHM58	5/8" x 5/8"
SHM34	3SHM34	3/4" x 3/4"
SHM100	3SHM100	1" x 1"
SHM114	3SHM114	1 1/4" x 1 1/4"
SHM112	3SHM112	1 1/2" x 1 1/2"
SHM200	3SHM200	2" x 2"

With Center Stop.



HOSE MENDERS HBxHB

Nylon	Poly	Connection Size
HM14316	3HM14316^	1/4" x 3/16"
HM14	3HM14^	1/4" x 1/4"
HM516^	3HM516^	5/16" x 5/16"
HM3814^	3HM3814	3/8" x 1/4"
HM1214	3HM1214^	1/2" x 1/4"
HM1238^	3HM1238^	1/2" x 3/8"
HM5838	3HM5838^	5/8" x 3/8"
HM58	3HM58^	5/8" x 5/8"

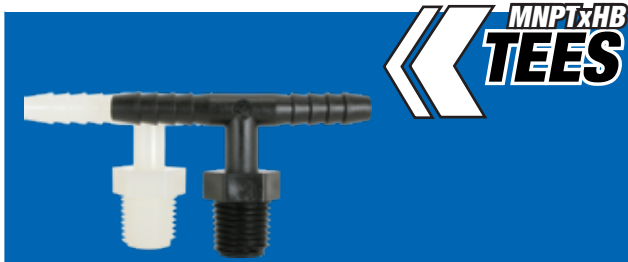

MNPT x HB TEES

Nylon	Poly	Connection Size
T1814T	3T1814T^	1/8" x 1/4"
T14T	3T14T	1/4" x 1/4"
T1438T	3T1438T	1/4" x 3/8"
T1412T	3T1412T	1/4" x 1/2"
T3814T^	3T3814T^	3/8" x 1/4"
T38T^	3T38T	3/8" x 3/8"
T3812T^	3T3812T^	3/8" x 1/2"
T1238T	3T1238T	1/2" x 3/8"
T12T	3T12T	1/2" x 1/2"
T1258T^	3T1258T^	1/2" x 5/8"
T1234T^	3T1234T^	1/2" x 3/4"
T3438T^	3T3438T	3/4" x 3/8"
T3412T^	3T3412T^	3/4" x 1/2"
T3458T^	3T3458T^	3/4" x 5/8"
T34T	3T34T	3/4" x 3/4"



HB x HB TEES

Nylon	Poly	Connection Size
T14	3T14	1/4" x 1/4"
T1438	3T1438	1/4" x 3/8"
T38**	3T38	3/8" x 3/8"
T3812	3T3812	3/8" x 1/2"
T3858^	3T3858^	3/8" x 5/8"
T1238	3T1238	1/2" x 3/8"
T12**	3T12	1/2" x 1/2"
T58	3T58	5/8" x 5/8"
T3412	3T3412	3/4" x 1/2"
T34	3T34	3/4" x 3/4"
T100	3T100	1" x 1"
T114	3T114	1 1/4" x 1 1/4"
T112	3T112	1 1/2" x 1 1/2"
T200^	3T200	2" x 2"

**Add -CSK suffix for clamshell retail packaging. • Add BC- prefix for barcoded product. ^Non-stock item, call for availability and pricing.



PIPE

NYLON &

MGHTxHB ADAPTERS



Nylon	Poly	Connection Size
D3414	3D3414 [^]	3/4" x 1/4"
D3438**	3D3438	3/4" x 3/8"
D3412**	3D3412	3/4" x 1/2"
D3458	3D3458	3/4" x 5/8"
D34**	3D34	3/4" x 3/4"

MGHTxHB ELBOWS



Nylon	Poly	Connection Size
ELD3414 [^]	3ELD3414 [^]	3/4" x 1/4"
ELD3438 [^]	3ELD3438 [^]	3/4" x 3/8"
ELD3412 [^]	3ELD3412 [^]	3/4" x 1/2"
ELD3458 [^]	3ELD3458	3/4" x 5/8"
ELD34	3ELD34	3/4" x 3/4"

FNPTxHB ADAPTERS



Nylon	Poly	Connection Size
Q14 [^]	3Q14	1/4" x 1/4"
Q12	3Q12	1/2" x 1/2"

HBxHB ELBOWS



Nylon	Poly	Connection Size
EL14HB	3EL14HB	1/4" x 1/4"
EL3814HB	3EL3814HB	3/8" x 1/4"
EL38HB	3EL38HB	3/8" x 3/8"
EL1214HB [^]	3EL1214HB [^]	1/2" x 1/4"
EL1238HB	3EL1238HB	1/2" x 3/8"
EL12HB**	3EL12HB	1/2" x 1/2"
EL58HB	3EL58HB	5/8" x 5/8"
EL3458HB [^]	3EL3458HB [^]	3/4" x 5/8"
EL34HB	3EL34HB	3/4" x 3/4"
EL100HB	3EL100HB	1" x 1"

FLAT SEAT HOSE BARBS



Nylon	Poly	Connection Size
C14	3C14	1/4"
C38**	3C38	3/8"
C12	3C12	1/2"
C58	3C58	5/8"
C34	3C34	3/4"
C100 [^]	3C100 [^]	1"

FNPTxHB TEES



Nylon	Poly	Connection Size
T34F	3T34F	3/4" x 3/4"

**Add -CSK suffix for clamshell retail packaging. • Add BC- prefix for barcoded product. [^]Non-stock item, call for availability and pricing.

FITTINGS

POLYPROPYLENE



MGHTxMNPT ADAPTERS

Nylon	Poly	Connection Size
E3438	3E3438	3/4" x 3/8"
E3412**	3E3412	3/4" x 1/2"
E34**	3E34	3/4" x 3/4"

FGHTxFNPT ADAPTER COUPLINGS

Nylon	Poly	Connection Size
J3412**	3J3412	3/4" x 1/2"

MGHTxFGHT ADAPTERS

Nylon	Poly	Connection Size
I34	3I34	3/4" x 3/4"

FGHTxMNPT ADAPTERS

Nylon	Poly	Connection Size
H34	3H34	3/4" x 3/4"

MGHTxFNPT ADAPTERS

Nylon	Poly	Connection Size
G3414^	3G3414^	3/4" x 1/4"
G3412	3G3412	3/4" x 1/2"
G34	3G34	3/4" x 3/4"

MPSxMNPT NIPPLES

Nylon	Poly	Connection Size
NB1614	3NB1614**	1/4" x 1/4"
NB1612	3NB1612	1/4" x 1/2"

**Add -CSK suffix for clamshell retail packaging. • Add BC- prefix for barcoded product. ^Non-stock item, call for availability and pricing.



PIPE NYLON &

STRAIGHT FGHT
SWIVEL NUTS



Nylon	Poly	Connection Size
B34**	3B34	3/4"

FPS NOZZLE
RETAINING NUTS



Nylon	Poly	Connection Size
B12	3B12	1/16"

MPSxHB
ELBOWS



Nylon	Poly	Connection Size
NTL14	3NTL14	1/16" x 1/4"
NTL38	3NTL38	1/16" x 3/8"
NTL38-C	3NTL38-C	1/16" x 3/8"
NTL12	3NTL12	1/16" x 1/2"
NTL12-C	3NTL12-C	1/16" x 1/2"
NTL58	3NTL58	1/16" x 5/8"
NTL34	3NTL34	1/16" x 3/4"

Hose barb with nozzle thread "L" standard nozzle body.
Includes B12 Nut (Except -C Models).

MPSxHB
TEES



Nylon	Poly	Connection Size
NTT38	3NTT38	1/16" x 3/8"
NTT38-C	3NTT38-C	1/16" x 3/8"
NTT12	3NTT12	1/16" x 1/2"
NTT12-C	3NTT12-C	1/16" x 1/2"
NTT58	3NTT58	1/16" x 5/8"
NTT34	3NTT34	1/16" x 3/4"
NTT34-C	3NTT34-C	1/16" x 3/4"

Hose barb with nozzle thread "T" standard nozzle body.
Includes B12 Nut (Except -C Models).

FOR 8027 NUT
HOSE BARBS



Nylon	Poly	Connection Size
K8414	3K8414	1/4"
K8438^	3K8438	3/8"
K8412	3K8412	1/2"

MPSxHB STRAIGHT
HOSE BARBS WITH NOZZLE THREAD



Nylon	Poly	Connection Size
38D	338D	1/16" x 3/8"
38D-C	338D-C	1/16" x 3/8"
3812D	33812D	1/16" x 1/2"
3812D-C	33812D-C	1/16" x 1/2"

Includes B12 Nut (Except -C Models).

**Add -CSK suffix for clamshell retail packaging. • Add BC- prefix for barcoded product. ^Non-stock item, call for availability and pricing.

FITTINGS

POLYPROPYLENE



NOZZLE NUTS FPS



Nylon	Poly	Connection Size
8027**	38027	1/16"

NOZZLE CAPS



Nylon	Poly	Connection Size
3942	33942	1/16"

MPSxHB CROSSES



Nylon	Poly	Connection Size
T38C	3T38C	1/16" x 3/8"
T12C^	3T12C	1/16" x 1/2"
T34C	3T34C	1/16" x 3/4"

Includes B12 Nut

FGHT CAPS



Nylon	Poly	Connection Size
N34	3N34	3/4"

CROSS 1/4" GAUGE PORT



Black Nylon	Connection Size
GCR1214-BN	1/2" x 1/4"

SPRAY TIP ADAPTERS

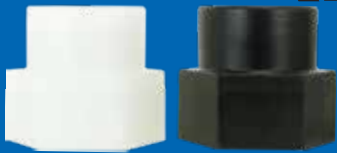

Nylon	Poly	Connection Size
NF1614	3NF1614**	1/16" x 1/4"

Female spray tip adaptor.

**Add -CSK suffix for clamshell retail packaging. • Add BC- prefix for barcoded product. ^Non-stock item, call for availability and pricing.



CAMLOCK

VALLEY INDUSTRIES polypropylene Camlocks allow you to quickly connect and disconnect fittings on pipes or hoses and are available in a wide variety of sizes and styles. Each camlock listed below is barcoded for retail sale.

TYPE-A



Part #	Size
CL-A-100P-BC	1"
CL-A-150P-BC	1½"
CL-A-200P-BC	2"
CL-A-300P-BC	3"

Includes a male grooved adapter and a female pipe thread.

TYPE-B



Part #	Size
CL-B-075P-BC	¾"
CL-B-150P-BC	1½"
CL-B-200P-BC	2"
CL-B-300P-BC	3"

Includes a female camlock and a male pipe thread.

TYPE-C



Part #	Size
CL-C-100P-BC	1"
CL-C-150P-BC	1½"
CL-C-200P-BC	2"
CL-C-300P-BC	3"

Includes a female camlock and a male hose barb.

TYPE-D



Part #	Size
CL-D-100P-BC	1"
CL-D-150P-BC	1½"
CL-D-200P-BC	2"

Includes a female camlock and a female pipe thread.

FITTINGS



TYPE-E



Part #	Size
CL-E-075P-BC	3/4"
CL-E-100P-BC	1"
CL-E-150P-BC	1 1/2"
CL-E-200P-BC	2"

Includes a male grooved adaptor and a male hose barb.

TYPE-F



Part #	Size
CL-F-100P-BC	1"
CL-F-150P-BC	1 1/2"
CL-F-200P-BC	2"
CL-F-300P-BC	3"

Includes a male grooved adaptor and a male pipe thread.

CAMLOCK CAP



Part #	Size
CL-CP-200P-BC	2"

CAMLOCK PLUG



Part #	Size
CL-PL-150P-BC	1 1/2"
CL-PL-200P-BC	2"





APPLICATIONS & NUMBERING

Our stainless steel fittings and pipe nipples are made from 304 or 316 stainless steel. They are for use with air, water, oil, natural gas, and steam under a maximum pressure 150 PSI at 72°F.

*304 prefix designates 304 stainless steel.
316 prefix designates 316 stainless steel.*

PIPE FITTINGS STAINLESS STEEL

ABBREVIATIONS

MPS Male Pipe Straight **FPS** Female Pipe Straight **MNPT** Male National Pipe Thread **FNPT** Female National Pipe Thread
HB Hose Barb **MGHT** Male Garden Hose Thread **FGHT** Female Garden Hose Thread **FBSP** Female British Straight Pipe

^{FNPT} CAPS



Part#	Connection Size
304-CP18	1/8"
304-CP14	1/4"
304-CP38	3/8"
304-CP12	1/2"
304-CP34	3/4"
304-CP100	1"
304-CP114	1 1/4"
304-CP112	1 1/2"
304-CP200	2"
304-CP300	3"
304-CP400	4"

^{FNPT} CROSSES



Part#	Connection Size
304-CR18	1/8"
304-CR14	1/4"
304-CR38	3/8"
304-CR12	1/2"
304-CR34	3/4"
304-CR100	1"
304-CR114	1 1/4"
304-CR112	1 1/2"
304-CR200	2"
304-CR300	3"
304-CR400	4"

^{MNPTxHB} FITTINGS



Part#	Connection Size
316-A14	1/4" x 1/4"
316-A1438	1/4" x 3/8"
316-A1412	1/4" x 1/2"
316-A38	3/8" x 3/8"
316-A3812	3/8" x 1/2"
316-A12	1/2" x 1/2"
316-A1238	1/2" x 3/8"
316-A1234	1/2" x 3/4"
316-A34	3/4" x 3/4"
316-A34100	3/4" x 1"
316-A100	1" x 1"
316-A114	1 1/4" x 1 1/4"
316-A112	1 1/2" x 1 1/2"
316-A200	2" x 2"
316-A300	3" x 3"
316-A400	4" x 4"

PIPE FITTINGS

STAINLESS STEEL

FNPTxFNPT COUPLINGS



Part#	Connection Size
304-FC18	1/8" x 1/8"
304-FC14	1/4" x 1/4"
304-FC38	3/8" x 3/8"
304-FC12	1/2" x 1/2"
304-FC34	3/4" x 3/4"
304-FC100	1" x 1"
304-FC114	1 1/4" x 1 1/4"
304-FC112	1 1/2" x 1 1/2"
304-FC200	2" x 2"
304-FC300	3" x 3"
304-FC400	4" x 4"
304-FHC14	1/4" x 1/4" Half Coupling
304-FHC38	3/8" x 3/8" Half Coupling
304-FHC12	1/2" x 1/2" Half Coupling
304-FHC100	1" x 1" Half Coupling

MNPTxFNPT BUSHINGS



Part#	Connection Size
304-RB1418	1/4" x 1/8"
304-RB3814	3/8" x 1/4"
304-RB1218	1/2" x 1/8"
304-RB1214	1/2" x 1/4"
304-RB1238	1/2" x 3/8"
304-RB3414	3/4" x 1/4"
304-RB3438	3/4" x 3/8"
304-RB3412	3/4" x 1/2"
304-RB10012	1" x 1/2"
304-RB10034	1" x 3/4"
304-RB11434	1 1/4" x 3/4"
304-RB114100	1 1/4" x 1"
304-RB11234	1 1/2" x 3/4"
304-RB112100	1 1/2" x 1"
304-RB112114	1 1/2" x 1 1/4"
304-RB200100	2" x 1"
304-RB200114	2" x 1 1/4"
304-RB200112	2" x 1 1/2"
304-RB300200	3" x 2"
304-RB400300	4" x 3"

MNPT HEX PLUGS



Part#	Connection Size
304-F18	1/8"
304-F14	1/4"
304-F38	3/8"
304-F12	1/2"
304-F34	3/4"
304-F100	1"
304-F114	1 1/4"
304-F112	1 1/2"
304-F200	2"
304-F300	3"
304-F400	4"

FNPTxFNPT ELBOWS 45°



Part#	Connection Size
304-LL185	1/8" x 1/8"
304-LL145	1/4" x 1/4"
304-LL385	3/8" x 3/8"
304-LL125	1/2" x 1/2"
304-LL345	3/4" x 3/4"
304-LL1005	1" x 1"
304-LL1145	1 1/4" x 1 1/4"
304-LL1125	1 1/2" x 1 1/2"
304-LL2005	2" x 2"
304-LL3005	3" x 3"
304-LL4005	4" x 4"

FNPTxFNPT ELBOWS



Part#	Connection Size
304-LL18	1/8" x 1/8"
304-LL14	1/4" x 1/4"
304-LL38	3/8" x 3/8"
304-LL12	1/2" x 1/2"
304-LL34	3/4" x 3/4"
304-LL100	1" x 1"
304-LL114	1 1/4" x 1 1/4"
304-LL112	1 1/2" x 1 1/2"
304-LL200	2" x 2"
304-LL300	3" x 3"
304-LL400	4" x 4"

FNPTxMNPT ELBOWS STREET



Part#	Connection Size
304-SE18	1/8" x 1/8"
304-SE14	1/4" x 1/4"
304-SE38	3/8" x 3/8"
304-SE12	1/2" x 1/2"
304-SE34	3/4" x 3/4"
304-SE100	1" x 1"
304-SE114	1 1/4" x 1 1/4"
304-SE112	1 1/2" x 1 1/2"
304-SE200	2" x 2"
304-SE300	3" x 3"
304-SE400	4" x 4"

PIPE FITTINGS

STAINLESS STEEL

SQUARE HEAD PLUGS MNPT



Part#	Connection Size
304-SP18	1/8"
304-SP14	1/4"
304-SP38	3/8"
304-SP12	1/2"
304-SP34	3/4"
304-SP100	1"
304-SP114	1 1/4"
304-SP112	1 1/2"
304-SP200	2"
304-SP300	3"
304-SP400	4"

FNPTxFNPT TEES



Part#	Connection Size
304-TT18	1/8"
304-TT14	1/4"
304-TT38	3/8"
304-TT12	1/2"
304-TT34	3/4"
304-TT100	1"
304-TT114	1 1/4"
304-TT112	1 1/2"
304-TT200	2"
304-TT300	3"
304-TT400	4"

FNPTxFNPT UNIONS



Part#	Connection Size
304-UN18	1/8"
304-UN14	1/4"
304-UN38	3/8"
304-UN12	1/2"
304-UN34	3/4"
304-UN100	1"
304-UN114	1 1/4"
304-UN112	1 1/2"
304-UN200	2"
304-UN300	3"
304-UN400	4"

MNPTxMNPT NIPPLES



Part#	Size x Length	Part#	Size x Length	Part#	Size x Length
304-1834	1/8" x 3/4"	304-12118	1/2" x 1 1/8"	304-114312	1 1/4" x 3 1/2"
304-18112	1/8" x 1 1/2"	304-12112	1/2" x 1 1/2"	304-114400	1 1/4" x 4"
304-18200	1/8" x 2"	304-12200	1/2" x 2"	304-114500	1 1/4" x 5"
304-18212	1/8" x 2 1/2"	304-12212	1/2" x 2 1/2"	304-114600	1 1/4" x 6"
304-18300	1/8" x 3"	304-12300	1/2" x 3"	304-112134	1 1/2" x 1 3/4"
304-18312	1/8" x 3 1/2"	304-12312	1/2" x 3 1/2"	304-112200	1 1/2" x 2"
304-18400	1/8" x 4"	304-12400	1/2" x 4"	304-112212	1 1/2" x 2 1/2"
304-18500	1/8" x 5"	304-12500	1/2" x 5"	304-112300	1 1/2" x 3"
304-18600	1/8" x 6"	304-12600	1/2" x 6"	304-112312	1 1/2" x 3 1/2"
304-1478	1/4" x 7/8"	304-34138	3/4" x 1 3/8"	304-112400	1 1/2" x 4"
304-14112	1/4" x 1 1/2"	304-34112	3/4" x 1 1/2"	304-112500	1 1/2" x 5"
304-14200	1/4" x 2"	304-34200	3/4" x 2"	304-112600	1 1/2" x 6"
304-14212	1/4" x 2 1/2"	304-34212	3/4" x 2 1/2"	304-200200	2" x 2"
304-14300	1/4" x 3"	304-34300	3/4" x 3"	304-200212	2" x 2 1/2"
304-14312	1/4" x 3 1/2"	304-34312	3/4" x 3 1/2"	304-200300	2" x 3"
304-14400	1/4" x 4"	304-34400	3/4" x 4"	304-200312	2" x 3 1/2"
304-14500	1/4" x 5"	304-34500	3/4" x 5"	304-200400	2" x 4"
304-14600	1/4" x 6"	304-34600	3/4" x 6"	304-200500	2" x 5"
304-14800	1/4" x 8"	304-100112	1" x 1 1/2"	304-200600	2" x 6"
304-141200	1/4" x 12"	304-100200	1" x 2"	304-300258	3" x 2 5/8"
304-38100	3/8" x 1"	304-100212	1" x 2 1/2"	304-300300	3" x 3"
304-38112	3/8" x 1 1/2"	304-100300	1" x 3"	304-300312	3" x 3 1/2"
304-38200	3/8" x 2"	304-100312	1" x 3 1/2"	304-300400	3" x 4"
304-38212	3/8" x 2 1/2"	304-100400	1" x 4"	304-300500	3" x 5"
304-38300	3/8" x 3"	304-100500	1" x 5"	304-300600	3" x 6"
304-38312	3/8" x 3 1/2"	304-100600	1" x 6"	304-400278	4" x 2 7/8"
304-38400	3/8" x 4"	304-114158	1 1/4" x 1 5/8"	304-400400	4" x 4"
304-38500	3/8" x 5"	304-114200	1 1/4" x 2"	304-400500	4" x 5"
304-38600	3/8" x 6"	304-114212	1 1/4" x 2 1/2"	304-400600	4" x 6"
304-38700	3/8" x 7"	304-114300	1 1/4" x 3"		

Other nipple lengths available. Call for details.

PIPE FITTINGS

BRASS

APPLICATIONS

Our brass fittings are acceptable for most water uses and petroleum applications such as gasoline and diesel fuel. Depending on the design, brass fittings are usually acceptable for use at relatively high pressure (500 PSI) and at temperatures up to 800° F.

Brass fittings are not acceptable for use with nitrogen compounds.

ABBREVIATIONS

MPS Male Pipe Straight FPS Female Pipe Straight MNPT Male National Pipe Thread FNPT Female National Pipe Thread
 HB Hose Barb MGHT Male Garden Hose Thread FGHT Female Garden Hose Thread FBSP Female British Straight Pipe

SWIVELS HOSE BARB



Part#	Connection Size
604.2A	1/2" FBSP x 3/8" HB
604.3A	1/2" FBSP x 1/2" HB

HOSE BARBS



Part#	Connection Size
900.046	3/4" MGHT x 3/8" HB x 2"
900.047	3/4" MGHT x 1/2" HB x 2"

NOZZLES



Part#	Connection Size	Orifice
900.040-8	1/16" FPS	#8
900.040-18	1/16" FPS	#18
900.054-8	1/4" FNPT	#8
900.054-18	1/4" FNPT	#18
900.054-24M	1/4" FNPT	#24

NIPPLES HEX



Part#	Connection Size
900.023	3/4" MGHT x 3/4" MGHT

NIPPLES HEX



Part#	Connection Size
900.018	3/4" MNPT x 3/4" MGHT

SWIVELS HOSE BARB



Part#	Connection Size
900.021	3/4" FGHT x 1/2" HB x 2"
900.034	3/4" FGHT x 3/4" HB x 2"
900.046	3/4" FGHT x 3/8" HB x 2"

ADAPTERS GARDEN HOSE



Part#	Connection Size
8105.0600.00	3/4" FGHT x 3/8" MNPT
8105.0601.00	3/4" FGHT x 1/2" MNPT
8105.0502.00	3/4" FGHT x 1/2" FNPT

ELBOWS 90° NOZZLE BODY



Part#	Connection Size
901.038	3/8" HB x 1/16" MPS
900.052	1/2" HB x 1/16" MPS

PIPE FITTINGS

BRASS

NOZZLE BODIES

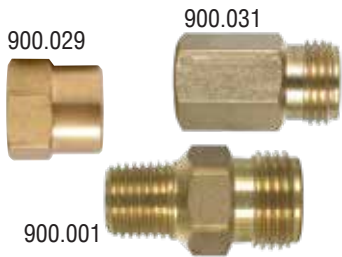

Part#	Connection Size
900.029	1/4" FNPT x 1/16" FPS
900.031	1/4" FNPT x 1/16" MPS
900.001*	1/4" MNPT x 1/16" MPS

*Also Available in Stainless Steel

NOZZLE BODY CAPS FPS



Part#	Connection Size
900.002	1/16" FPS (short)
900.002-CSK	1/16" FPS (short) 4-Pk
900.006	1/16" FPS (deep)

NOZZLE BODY TEES HBxMPS



Part#	Connection Size
902.038	3/8" HB x 1/16" MPS
900.053	1/2" HB x 1/16" MPS

NOZZLE BLANKS



Part#	Connection Size
900.016	Nozzle Body Block-Off Plate
900.016-CSK	As Above, Clamshelled

FILTER SCREEN



Part#	Connection Size
900.009	Brass Filter Screen

NOZZLE BALL VALVE



Part#	Connection Size
BBVL-23220	1/4" FNPT x 1/16" MPS
91.900.156	1/4" MNPT x 1/16" MPS

NOZZLE BODY SWIVELS SINGLE

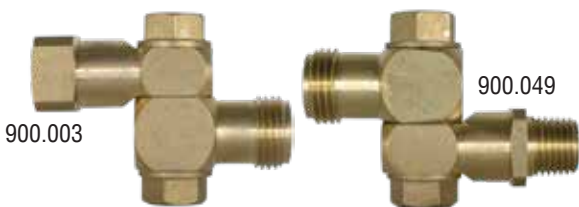

Part#	Connection Size
900.003	1/4" FNPT x 1/16" MPS
900.049	1/4" MNPT x 1/16" MPS

NOZZLE BODY SWIVELS DOUBLE



Part#	Connection Size
900.050	1/4" MNPT x 1/16" MPS
900.004	1/4" FNPT x 1/16" MPS

BALL VALVES

316 STAINLESS SERIES 86 STANDARD PORT

2 Piece, 2000 PSI Ball Valve
Standard Port 316 Stainless Steel Heavy Wall

Part#	FNPT	D	L	S	H
86-14	¼"	0.374	2.047	4.114	2.028
86-38	⅜"	0.374	2.047	4.114	2.028
86-12	½"	0.500	2.539	4.114	2.008
86-34	¾"	0.590	2.697	5.020	2.106
86-100	1"	0.787	3.248	5.020	2.283
86-114	1¼"	0.984	3.681	6.575	2.874
86-112	1½"	1.260	4.350	6.575	3.150
86-200	2"	1.500	4.622	7.600	3.327

FEATURES

Investment cast body and cap.
Teflon® seals and seats for smooth operation and proper seating characteristics.
2000 PSI Rating (Water/Oil/Gas).
-60° to 450° F operating temperature.
Adjustable stem packing.
Blow-out proof stem and ball are made of 316 stainless steel.
Locking device on handle.

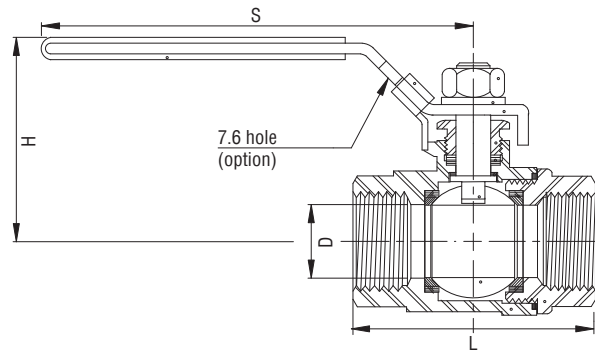

316 STAINLESS SERIES 88 FULL PORT

2 Piece, 1000 PSI Ball Valve
Full Port 316 Stainless Steel

Part#	FNPT	D	L	S	H
88-14	¼"	0.456	1.831	4.094	1.890
88-38	⅜"	0.456	1.890	4.094	1.890
88-12	½"	0.562	2.520	4.094	2.047
88-34	¾"	0.787	2.913	4.843	2.402
88-100	1"	0.984	3.425	4.843	2.559
88-114	1¼"	1.260	3.976	6.063	3.150
88-112	1½"	1.496	4.331	6.063	3.307
88-200	2"	1.969	5.197	7.441	3.819
88-212	2½"	2.520	5.710	9.606	5.354
88-300	3"	2.992	7.362	9.606	5.709

FEATURES

Investment cast body and cap.
Teflon® seals and seats for smooth operation and proper seating characteristics.
1000 PSI Rating (Water/Oil/Gas).
-60° to 450° F operating temperature.
Adjustable stem packing.
Blow-out proof stem and ball are made of 316 stainless steel.
Locking device on handle.

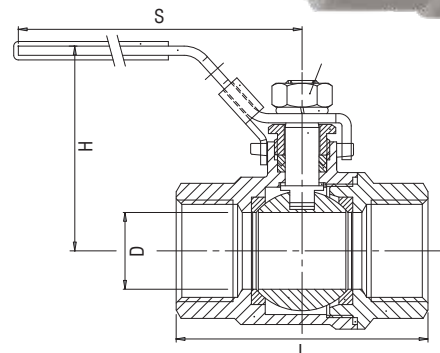

BALL

BRASS BBV SERIES FULL PORT

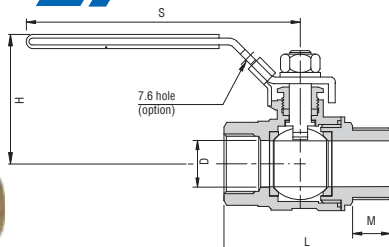

Part#	FNPT	D	L	S	H
BBV-14	1/4"	0.39	2.02	3.85	1.75
BBV-38	3/8"	0.39	2.02	3.85	1.75
BBV-12	1/2"	0.59	2.44	3.85	1.88
BBV-34	3/4"	0.78	2.71	4.80	2.28
BBV-100	1"	0.98	3.07	4.80	2.44
BBV-114	1 1/4"	1.25	3.42	6.02	3.07
BBV-112	1 1/2"	1.57	3.89	6.02	3.34
BBV-200	2"	1.96	4.43	6.37	3.79
BBV-300	3"	3.00	6.06	7.75	4.50

FEATURES

Investment cast body and cap.
Teflon® seals & seats smooth operation & proper seating.
600 PSI rating (W.O.G.) 100 PSI steam.
-40° to 366° F operating temperature.
Adjustable stem packing.
Blow-out proof stem.
Chrome plated brass ball.

BUTTERFLY HANDLE 85 SERIES STANDARD PORT



Part#	Inlet/Outlet
85-14B	1/4" FNPT x 1/4" FNPT

FEATURES

Investment cast body and cap.
Teflon® seals & seats for smooth operation & proper seating.
1000 PSI rating (W.O.G.).
-60° to 450° F operating temperature.
Adjustable stem packing.
316 Stainless Steel blow-out proof stem & ball.
Non-locking handle.
1.5" overall length.
One piece body.

CHROMED BRASS ECONOMY LEVER HANDLE



Part#	Inlet/Outlet	Part#	Inlet/Outlet
MVL18FF	1/8" FNPT x FNPT	MVL18FM	1/8" FNPT x MNPT
MVL14FF	1/4" FNPT x FNPT	MVL14FM	1/4" FNPT x MNPT
MVL38FF	3/8" FNPT x FNPT	MVL38FM	3/8" FNPT x MNPT
MVL12FF	1/2" FNPT x FNPT	MVL12FM	1/2" FNPT x MNPT

FEATURES

Nylon lever handled.
300 PSI rating (CWP).
-4° to 250° F temp. rating.
Chromed brass body, ball & stem.
Teflon® seat and Viton® seals.

CHROMED BRASS ECONOMY BUTTERFLY HANDLE



Part#	Inlet/Outlet	Part#	Inlet/Outlet
MVT18FF	1/8" FNPT x FNPT	MVT18FM	1/8" FNPT x MNPT
MVT14FF	1/4" FNPT x FNPT	MVT14FM	1/4" FNPT x MNPT
MVT38FF	3/8" FNPT x FNPT	MVT38FM	3/8" FNPT x MNPT
MVT12FF	1/2" FNPT x FNPT	MVT12FM	1/2" FNPT x MNPT

FEATURES

Butterfly t-handle.
300 PSI rating (CWP).
-4° to 250° F temp. rating.
Chromed brass body, ball & stem.
Teflon® seat and Viton® seals.

VALVES

PBV2 SERIES TWO-WAY POLYPROPYLENE

FEATURES

Precision molded in glass reinforced polypropylene for strength and chemical resistance.

Teflon® seats for smooth operation and proper sealing characteristics. EPDM o-rings to handle most fertilizers and many chemicals. Viton® available on request.

Positive handle stops for turning off and on.

Maximum operating pressure 240 PSI for sizes up to 1 1/4", 150 PSI for sizes over 1 1/4".



Part#	FNPT	A	B	C	D	E	F (NPT)	G	H	I	L
PBV2-38	3/8"	2.36	1.65	1.65	0.63	2.32	3/8	0.91	1.71	1.75	3.46
PBV2-12	1/2"	2.36	1.65	1.65	0.63	2.32	1/2	0.91	1.71	1.75	3.46
PBV2-34	3/4"	2.36	1.65	1.65	0.63	2.32	3/4	0.91	1.71	1.75	3.46
PBV2-100	1"	2.87	1.65	2.09	0.79	2.72	1	0.91	1.83	2.05	3.88
PBV2-114	1 1/4"	3.15	1.65	3.03	0.79	3.23	1 1/4	0.98	2.11	2.17	4.27
PBV2-112	1 1/2"	3.42	1.93	3.15	0.79	3.90	2 1/2	1.10	2.46	2.50	4.96
PBV2-200	2"	4.33	1.93	5.12	0.79	4.53	2	1.18	2.87	2.97	5.85
PBV2-212	2 1/2"	4.84	1.77	3.54	0.98	5.71	2 1/2	1.73	4.06	4.29	8.35

PBV3 SERIES THREE-WAY POLYPROPYLENE

FEATURES

Precision molded in glass reinforced polypropylene for strength and chemical resistance.

Teflon® seats for smooth operation and proper sealing characteristics. EPDM o-rings to handle most fertilizers and many chemicals. Viton® available on request.

Positive handle stops for turning off and on.

Maximum operating pressure 240 PSI for sizes up to 1-1/4", 150 PSI for sizes over 1-1/4".

CF notation in the part number stands for Continuous Flow.

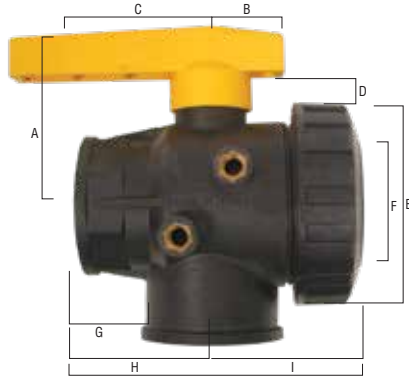

Part#	FNPT	A	B	C	D	E	F (NPT)	G	H	I	L
PBV3-12	1/2"	2.36	1.65	1.65	0.62	2.32	1/2	0.90	1.71	1.75	3.46
PBV3-34	3/4"	2.36	1.65	1.65	0.62	2.32	3/4	0.90	1.71	1.75	3.46
PBV3-100	1"	2.87	1.65	2.09	0.79	2.72	1	0.91	1.83	2.05	3.88
PBV3-100CF	1"	2.87	1.65	2.09	0.79	2.72	1	0.91	1.83	2.05	3.88
PBV3-114	1 1/4"	3.15	1.65	3.03	0.79	3.23	1 1/4	0.98	2.11	2.17	4.27
PBV3-112	1 1/2"	3.42	1.93	3.15	0.79	3.90	1 1/2	1.10	2.46	2.50	4.96
PBV3-112CF	1 1/2"	3.42	1.93	3.15	0.79	3.90	1 1/2	1.10	2.46	2.50	4.96
PBV3-200	2"	4.33	1.93	5.12	0.79	4.53	2	1.18	2.87	2.97	5.85

BALL VALVES

MNPTxHB VALVES POLYPROPYLENE



Part#	Connection Size
PBV-38HB12	1/2" Male NPT x 3/8" HB 150 PSI Max
PBV-38HB12-CSK	Same as above w/clamshell packaging

HBxHB VALVES POLYPROPYLENE



Part#	Connection Size
PBV-38HB	3/8" HB x 3/8" HB 150 PSI Max
PBV-38HB-CSK	Same as above w/clamshell packaging

FNPTxFNPT BOLTED



Part#	Connection Size	# of Bolts
BLTBV-204-BC	2"	4
BLTBV-206-BC	2"	6
BLTBV-300-BC	3"	
Other Sizes Available. Call For Details.		

FNPTxFNPT TWO-WAY ZINC PLATED



Part#	Connection Size	GPM
8109.2601.00	1/4" FPT x 1/4" F	2.64
8109.2602.00	3/8" FPT x 3/8" F	6.60
8109.2603.00	1/2" FPT x 1/2" F	10.57

FEATURES	
Operating Temp	212 °F
Material	Chrome Plated Steel
PSI Rating	7400 Max
Handle Type	Steel, Bent

FNPTxFNPT TWO-WAY ZINC PLATED



Part#	Connection Size
8402.2611.00	1 1/4"
8402.2612.00	1 1/2"

FEATURES	
Operating Temp	212 °F
Material	Zinc Plated Steel
PSI Rating	5000 Max
Handle Type	Steel, Bent

FNPTxFNPT THREE-WAY ZINC PLATED



Part#	Connection Size
8402.2622.00	1 1/4"
8402.2628.00	1 1/2"
8402.2629.00	2"

FEATURES	
Operating Temp	212 °F
Material	Zinc Plated Steel
PSI Rating	5000 Max
Handle Type	Steel, Bent



CLAMPS ^{T-BOLT}



PURPOSE

To provide a quick, yet effective means of clamping a variety of fittings to a wide range of hose. T-Bolts can be applied with a standard socket wrench. They provide 360° sealing surface by using a shoe or formed bridge. Bag quantities of 50.

Part#	Nominal	From	To
TB-840150	1-1/2"	1-3/8"	1-9/16"
TB-840175	1-3/4"	1-5/8"	1-13/16"
TB-840200	2"	1-7/8"	2-1/16"
TB-840225	2-1/4"	2-1/8"	2-5/16"
TB-840238	2-3/8"	2-1/4"	2-7/16"
TB-840250	2-1/2"	2-3/8"	2-9/16"
TB-840275	2-3/4"	2-17/32"	2-13/16"
TB-840300	3"	2-25/32"	3-1/16"
TB-840325	3-1/4"	3-1/32"	3-5/16"
TB-840350	3-1/2"	3-9/32"	3-9/16"
TB-840375	3-3/4"	3-17/32"	3-16/16"
TB-840425	4-1/4"	4-1/32"	4-5/16"
TB-840450	4-1/2"	4-9/32"	4-9/16"
TB-840475	4-3/4"	4-17/32"	4-13/16"

FEATURES

- 0.025" band thickness
- 3/4" wide band
- Self locking nuts
- 75 in/lb torque rating
- Bag Quantity: 50

SERVICES

The T-Bolt clamp is a high strength, reliable clamp with numerous applications in both the commercial and industrial markets including hose and duct work connections for air, oil, water and other types of low pressure fluid lines.

CLAMP ^{PIPE}



Part#	Pipe ID
CPC-100	1"

Use with Schedule 80 Polypropylene pipe.

ANCHOR ^{BRACKET}



Part#	Description
TD-150	1.5" Tie down
TD-200	2" Tie down

Tank tie down strap, anchor bracket 2"

SEALANT ^{PIPE}



Part#	Size
25790	#5 Rectorseal, 1.75 oz. tube
25631	#5 Rectorseal, 1/4 pint can
25551	#5 Rectorseal, 1/2 pint can
25431	#5 Rectorseal, 1 pint can
28651	# 21 Rectorseal, 1/2 pint can
28541	# 21 Rectorseal, 1 pint can

SEALANT ^{TAPE} PTFE



Part#	Width/Length	#/box
12-60	1/2" by 60"	100
12-260	1/2" by 260"	100
12-520	1/2" by 520"	100
34-520	3/4" by 520"	100
100-1296	1" by 1296"	150



MNPTxMNPT LOW PROFILE NYLON

Nylon Bowl				Clear Bowl			
Part#	Size	Gasket	Mesh	Part#	Size	Gasket	Mesh
14644	¼"	EPDM	20	14656	¼"	EPDM	20
11474	¼"	EPDM	40	11633	¼"	EPDM	40
12992	¼"	EPDM	80	11469	¼"	EPDM	80
17933	¼"	Viton	20	10910	¼"	Viton	20
11215	¼"	Viton	40	10911*	¼"	Viton	40
11043	¼"	Viton	80	10912*	¼"	Viton	80
17934	½"	EPDM	20	12379	½"	EPDM	20
12546	½"	EPDM	40	11434	½"	EPDM	40
12815	½"	EPDM	80	13090	½"	EPDM	80
11109	½"	Viton	20	10924	½"	Viton	20
12171	½"	Viton	40	10925	½"	Viton	40
10923	½"	Viton	80	10981	½"	Viton	80

*Available with FPT Connections

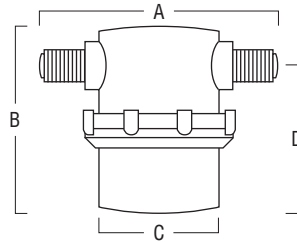

Dimensions	
A	3.06"
B	2.42"
C	1.86"
D	1.98"
Filter Area	4.27 sq"



MNPTxMNPT LOW PROFILE POLYPROPYLENE

Polypropylene Bowl				Clear Bowl			
Part#	Size	Gasket	Mesh	Part#	Size	Gasket	Mesh
17912	¼"	EPDM	20	14628	¼"	EPDM	20
11642	¼"	EPDM	40	14629	¼"	EPDM	40
14591	¼"	EPDM	80	14630	¼"	EPDM	80
17913	¼"	Viton	20	17916	¼"	Viton	20
13914	¼"	Viton	40	12326	¼"	Viton	40
13915	¼"	Viton	80	12678	¼"	Viton	80
17917	½"	EPDM	20	14637	½"	EPDM	20
17918	½"	EPDM	40	12250	½"	EPDM	40
17919*	½"	EPDM	80	12397	½"	EPDM	80
17920	½"	Viton	20	18456	½"	Viton	20
17921	½"	Viton	40	17923	½"	Viton	40
17922	½"	Viton	80	12410	½"	Viton	80

*Available with FPT Connections

STRAINERS

FNPTxFNPT STANDARD NYLON

Nylon Bowl				Clear Bowl			
Part#	Size	Gasket	Mesh	Part#	Size	Gasket	Mesh
11407	1/2"	EPDM	40	17935	1/2"	EPDM	20
11297	3/4"	EPDM	20	17936	1/2"	EPDM	40
11298	3/4"	EPDM	40	12553	1/2"	EPDM	80
11300	3/4"	EPDM	80	10949	1/2"	Viton	40
10962	3/4"	Viton	80	10946	1/2"	Viton	80
				12460	3/4"	EPDM	20
				11299	3/4"	EPDM	40
				11301	3/4"	EPDM	80
				10985	3/4"	Viton	40
				10986	3/4"	Viton	80

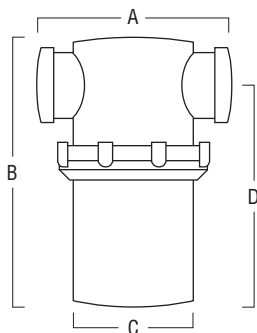

Dimensions					
Size	A	B	C	D	F. Area
1/2"	3.64"	5.35"	2.95"	4.80"	19 sq"
3/4"	3.64"	5.35"	2.95"	4.80"	19 sq"

FNPTxFNPT STANDARD POLYPROPYLENE

Polypropylene Bowl				Clear Bowl			
Part#	Size	Gasket	Mesh	Part#	Size	Gasket	Mesh
14577	1/2"	EPDM	20	14687	1/2"	EPDM	20
11354	1/2"	EPDM	40	12356	1/2"	EPDM	40
11385	1/2"	EPDM	80	14688	1/2"	EPDM	80
12375	1/2"	Viton	40	17925	1/2"	Viton	20
17924	1/2"	Viton	80	17926	1/2"	Viton	40
11262	3/4"	EPDM	20	13752	1/2"	Viton	80
11263	3/4"	EPDM	40	14689	3/4"	EPDM	20
11264	3/4"	EPDM	80	12262	3/4"	EPDM	40
11264-BC	3/4"	EPDM	80	14466	3/4"	EPDM	80
12573	3/4"	Viton	20	17927	3/4"	Viton	20
11376	3/4"	Viton	40	17928	3/4"	Viton	40
11277	3/4"	Viton	80	14323	3/4"	Viton	80

-BC Suffix Denotes Product is Offered with Barcoding





Nylon Bowl

Part#	Size	Gasket	Mesh	Part#	Size	Gasket	Mesh
11303	1"	EPDM	20	14674	1"	EPDM	20
11304	1"	EPDM	40	12165	1"	EPDM	40
11305	1"	EPDM	80	12324	1"	EPDM	80
10999	1"	Viton	20	11005	1"	Viton	20
11001	1"	Viton	40	11007	1"	Viton	40
11002	1"	Viton	80	11003	1"	Viton	80
17938	1¼"	EPDM	20	13716	1¼"	EPDM	20
11308	1¼"	EPDM	40	12166	1¼"	EPDM	40
11309	1¼"	EPDM	80	12430	1¼"	EPDM	80
11021	1¼"	Viton	20	11026	1¼"	Viton	20
11023	1¼"	Viton	40	11028	1¼"	Viton	40
11019	1¼"	Viton	80	11024	1¼"	Viton	80
17939	1½"	EPDM	20	11538	1½"	EPDM	20
11606	1½"	EPDM	40	12138	1½"	EPDM	40
11528	1½"	EPDM	80	12325	1½"	EPDM	80
11432	1½"	Viton	20	11145	1½"	Viton	20
11360	1½"	Viton	40	11054	1½"	Viton	40
11518	1½"	Viton	80	11186	1½"	Viton	80

Clear Bowl

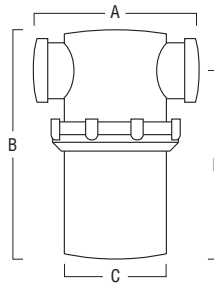

Dimensions

Size	A	B	C	D	F.Area
1"	4.62"	6.36"	4.00"	5.60"	33 sq"
1¼"	5.00"	7.10"	4.00"	6.10"	36 sq"
1½"	5.16"	8.10"	4.00"	6.93"	39 sq"



Polypropylene Bowl

Part#	Size	Gasket	Mesh	Part#	Size	Gasket	Mesh
11265	1"	EPDM	20	12943	1"	EPDM	20
11266*	1"	EPDM	40	12488	1"	EPDM	40
11267*	1"	EPDM	80	12465	1"	EPDM	80
12338	1"	Viton	20	17929	1"	Viton	20
11378	1"	Viton	40	17930	1"	Viton	40
12336	1"	Viton	80	14915	1"	Viton	80
11268	1¼"	EPDM	20	13740	1¼"	EPDM	20
11269	1¼"	EPDM	40	12415	1¼"	EPDM	40
11270*	1¼"	EPDM	80	12389	1¼"	EPDM	80
17637	1¼"	Viton	20	17741	1¼"	Viton	20
11379	1¼"	Viton	40	17931	1¼"	Viton	40
12337	1¼"	Viton	80	14916	1¼"	Viton	80
11271-VI	1½"	EPDM	20	13850	1½"	EPDM	20
11272*	1½"	EPDM	40	14460	1½"	EPDM	40
11273	1½"	EPDM	80	14464	1½"	EPDM	80
12572	1½"	Viton	20	17932	1½"	Viton	20
11380	1½"	Viton	40	13539	1½"	Viton	40
11381	1½"	Viton	80	13751	1½"	Viton	80

Clear Bowl



*Product is available with barcoding. Add -BC suffix to end of part #.

STRAINERS



« SUCTION STRAINERS



Part#	Connection Size	Mesh
10403	3/8" Barb	50 x 50
10416	3/8" FNPT	40 x 36
10421	1/2" FNPT	40 x 30
11071	3/4" NPT	20 x 20

Mushroom Style

« O-RINGS/SCREENS FOR STRAINERS

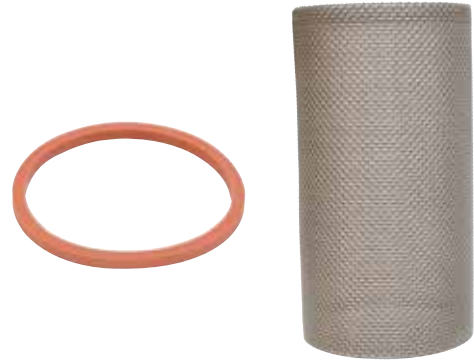

Part#	Description
11302-CSK	EPDM O-Ring for 3/4" Strainer, Clamshelled
11306-VI	EPDM O-Ring for 1" or 1.5" Nylon Strainers
10523-VI	1" Strainer Screen 50 Mesh
10523-VI-BC	1" Strainer Screen 50 Mesh, Barcoded
10524-BC	1" 124A Strainer Screen, 80 Mesh, Barcoded
10849-BC	1 1/2" Line Strainer Screen, 50 Mesh, Barcoded
10866-VI	1 1/2" Line Strainer Screen, 20x20, Stainless

« CLASS 800 Y-STRAINER



Part#	FNPT	L	A	H
316-YS38	3/8"	2.559	0.748	1.811
316-YS12	1/2"	2.559	0.748	1.811
316-YS34	3/4"	3.150	0.905	2.283
316-YS112	1 1/2"	4.724	1.614	3.346

FEATURES

Investment Cast Body
800 PSI maximum pressure
230° F maximum working temperature

« FNPT PIPE POLYPROPYLENE



Part#	NPT
075-8-00P	3/4" no spacing
075-8-10P	3/4" with 10" spacing, 3/8" holes
075-8-20P	3/4" with 20" spacing, 3/8" holes
100-8-00P	1" no spacing
100-8-10P	1" with 10" spacing, 3/8" holes
100-8-20P	1" with 20" spacing, 3/8" holes

Schedule 80, Black. 20 Foot lengths standard



WHEEL & TIRE

PRESSURE RELIEF VALVES



Part#	PSI	Inlet (MNPT)
RV2064-01-58	150 Max	1/2"
RV2064-06-58	400 Max	1/2"
RV2064-06-58-CSK	400 Max	1/2", Clamshelled
RV2066-01-58	150 Max	3/4"
RV2066-05-58	250 Max	3/4"
RV2066-06-58	400 Max	3/4"
RV2066-05-58-CSK	400 Max	3/4", Clamshelled

FEATURES

3/4" FNPT discharge
Polypropylene & Brass Construction



Part#	PSI
RV34-300B	300 Max
RV34-700B	700 Max

FEATURES

3/4" MNPT inlet
Solid brass construction

Part#	PSI
RV12-700B-CSK	700 Max

FEATURES

1/2" MNPT inlet
Solid brass construction



Part#	PSI
RV34-300A	300 Max

FEATURES

3/4" MNPT inlet
Aluminum construction

FUEL TRANSFER GUN

3/4" HB INLET



Part#	Description
DN-506530	Polypropylene Fuel Transfer Gun

FEATURES

Non-Locking	Stainless Spring
150 PSI Max	3/4" Hose Barb Connection
40 GPM	Viton Pin Bushing & Rubber Parts

10", FOAM FILLED TIRE ASSEMBLY



Part #	TWA410/350-4-PU TWA410/350-4-PU-BC (Barcoded)
Description	10" Polyurethane Filled Tire & Wheel
Size	410/350-4
Tread	2-ply 'Turf Tread'
Bearing ID	5/8" ID
Ball Bearing	Steel
Rim Size	4" Diameter
Tread Width	2-5/8"
Hub Width	2-1/4"
Load Rating	400 lbs

ASSEMBLIES

PNEUMATIC 10" & 13"



Part #	TWA410/350-4	TWA13X5-6
Description	10" Tire & Wheel	13" Tire & Wheel
Size	410/350-4	13.0 X 5.00 -6.00
Tread	2-ply 'Turf Tread'	2-ply 'Turf Tread'
Bearing ID	5/8" ID	3/4" ID
Ball Bearing	Steel	Steel
Rim Size	4" Diameter	6 3/8" Diameter
Tread Width	2-5/8"	4"
Hub Width	2-1/4"	2-1/4"
Load Rating	265 lbs	330 lbs

PNEUMATIC 15"



Part #	Description
TWA15x600-6	15" Tire & Wheel Assembly
FEATURES 	
2-ply Tires With 'Turf Tread'	
3/4" ID Steel Ball Bearing	
6" Rim	
4-1/2" Tread Width	
3-1/8" Hub Width	
Load Rating: 396 lbs	

PNEUMATIC 18"



Part #	Description
TWA-16x6.5-8/4-HOLE	18" Tire and Wheel Assembly
FEATURES 	
4-ply Tires	
4 Hole Bolt Pattern with 4" Spacing	
9" Rim	
7" Tread Width	
Max Load 785 lbs. at 26 PSI	

HEAVY DUTY POLYMER 12"



Part #	Description
TWA12x1.75-1/2	12" Wheel Assembly. Replacement wheel for PCD-E3-009B-MM
FEATURES 	
Solid Polymer Tires	
3/4" ID Steel Ball Bearing	
Chemical Resistant Polymer Rim	
2" Tread Width	
Solid 5 Spoke Zero PSI Wheel	

FRAME KITS

Visit www.master-mfg.com for more info.



QUICK ATTACH ATV BOOM MOUNTING KIT 15-25 GALLON



Part#	FEATURES
SSFK-ATV-QA	Converts spot sprayer to ATV sprayer Spring-loaded mounts for perfect spray height Installs at bottom of 15 & 25 gallon tanks Includes two ratchet straps

UNIVERSAL 2" RECEIVER BOOM MOUNT 10 POSITION



Part#	FEATURES
SSFK-UTVBR	Adjustable self-leveling positions Tension locking system for snug fit in receiver Tool free installation Universal setup for Master Mfg spray booms

RANGE XL SERIES 3-POINT KIT 40-60 GALLON



Part#	FEATURES
SSFK-4060S3B-MM	Converts spot sprayer to 3-point sprayer Cat 1 setup and boom ready

RANGE XL SERIES UTV KIT 40-60 GALLON



Part#	FEATURES
SSFK-4060UTV-MM	Converts spot sprayer to UTV sprayer Boom ready

BOOM KITS

7' COVERAGE BOOM KIT 2-NOZZLE

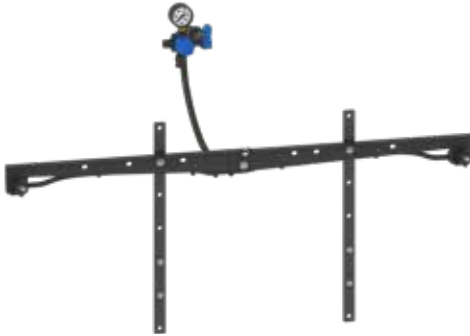

Part#

SSBK-240

FEATURES

- Dual, quick-attach deflector nozzles
- Pressure regulating system with 100 PSI gauge
- Adjustable brackets for the perfect spray height
- Compact design to prevent damage from obstacles
- 1.8 GPM required
- Includes 12V wire harness with power switch
- Compatible with Master MFG mounting kits

7' COVERAGE BOOM KIT FOLDING, 4-NOZZLE



Part#

SSBK-420

FEATURES

- Four, quick-attach flat fan nozzles
- Pressure regulating system with 100 PSI gauge
- Adjustable brackets for the perfect spray height
- Folding wings for compact storage
- 1.8 GPM required
- Includes 12V wire harness with power switch
- Compatible with Master MFG mounting kits

10' COVERAGE BOOM KIT FOLDING, 3-NOZZLE



Part#

SSBK-340

FEATURES

- Three, quick-attach deflector nozzles
- Pressure regulating system with 100 PSI gauge
- Adjustable brackets for the perfect spray height
- Folding wings for compact storage
- 1.8 GPM required
- Includes 12V wire harness with power switch
- Compatible with Master MFG mounting kits

10' COVERAGE BOOM KIT FOLDING, 6-NOZZLE



Part#

SSBK-620

FEATURES

- Six, quick-attach flat fan nozzles
- Pressure regulating system with 100 PSI gauge
- Adjustable brackets for the perfect spray height
- Folding wings for compact storage
- 1.8 GPM required
- Includes 12V wire harness with power switch
- Compatible with Master MFG mounting kits

BOOM

Visit www.master-mfg.com for more info.

13' COVERAGE BOOM KIT FOLDING, 8-NOZZLE

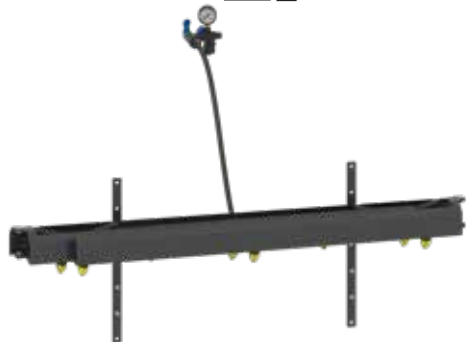

Part#

SSBK-820

FEATURES

- Eight, quick-attach flat fan nozzles
- Pressure regulating system with 100 PSI gauge
- Adjustable brackets for the perfect spray height
- Folding wings for compact storage
- 2.2 GPM required
- Includes 12V wire harness with power switch
- Compatible with Master MFG mounting kits

30' COVERAGE BOOM KIT PRECISION & BROADCAST



Part#

SSBK-PNB

Description

Up to 30' Coverage with Broadcast Nozzles and Precision Spraying with 3 Flat Fan Nozzles



Go from precision spraying with flat fan nozzles to broadcast spraying using boomless nozzles, with a simple twist of the outer assemblies. The center precision assembly includes an easy on/off knob.

23' COVERAGE CHAIN BOOM KIT FOLDING, 14-NOZZLE



Part#

SSBK-1420

FEATURES

- Fourteen, quick-attach flat fan nozzles.
- Pressure regulating system with 100 PSI gauge.
- Adjustable brackets for the perfect spray height.
- Chain supported arms that fold-in for compact storage.
- 5.0 GPM pump required.

GENTER TWIST NOZZLE BODY FOR SSBK-PNB



Part#

G-8234084-CSK

Description

Center Nozzle Body for the SSBK-PNB.

OUTER TWIST NOZZLE BODY FOR SSBK-PNB



Part#

G-8244190-KIT-CSK

Description

Outer Twist Nozzle Body Assembly for the SSBK-PNB.

KITS

16' COVERAGE BOOMLESS NOZZLE KIT



Part#

SSBK-NB-2

FEATURES

- Single boomless nozzle
- Pressure regulating system with 100 PSI gauge
- Adjustable brackets for the perfect spray height
- Compact design to avoid obstacles
- 1.8+ GPM required
- Includes 12V wire harness with power switch
- Compatible with Master MFG mounting kits

16-22' COVERAGE BOOMLESS NOZZLE KIT



Part#

SSBK-DNB-2

Coverage

16'

GPM

2.0

SSBK-DNB-3

22'

3.0

FEATURES

- Dual boomless nozzles
- Pressure regulating system with 100 PSI gauge
- Adjustable brackets for the perfect spray height
- Compact design to avoid obstacles
- Includes 12V wire harness with power switch
- Compatible with Master MFG mounting kit

5/8/16' COVERAGE BOOMLESS NOZZLE KIT



Part#

SSBK-3TDNB

Description

Dual Boomless Nozzle, 5/8/16' Coverage

FEATURES

- Dual boomless nozzles + single deflector for precision spray
- Pressure regulating system with 100 PSI gauge
- Adjustable brackets for the perfect spray height
- Compact design to avoid obstacles
- Includes 12V wire harness with power switch
- Compatible with Master MFG mounting kits

16' COVERAGE BOOMLESS NOZZLE WAND KIT



Part#

SSBK-SNB-2

FEATURES

- Shut-off valve to spray boom
- Adjustable nozzle wand bracket for the perfect spray height
- Compact design to avoid obstacles
- Includes 12V wire harness with power switch
- Compatible with Master MFG mounting kits



EVERFLO

Visit www.everflopump.com for more info.



DIAPHRAGM PUMP ^{1.1 GPM} QUICK ATTACH PORTS



Part#	Port Type	Packaging
EF1100-QA	Quick Attach	Bulk
EF1100-QA-BC	Quick Attach	Barcoded
FEATURES		
40 PSI	Polypropylene Pump Housing & Valve Plate	
4 Max Amps	Zinc Plated Steel Fasteners	
1.3 lbs Dry	Self Priming to 4'	
CE Approved	Painted Steel 2" Motor Shell	
	140° F Max Temperature Rating	

DIAPHRAGM PUMP ^{2.0 GPM ECONOMY} QA OR NPT PORTS



Part#	Port Type	Packaging
EF200EQ	Quick Attach	Bulk
EF200EQ-BC	Quick Attach	Barcoded
EF200E	3/8" FNPT	Bulk
EF200E-BC	3/8" FNPT	Barcoded
FEATURES		
70 PSI	Polypropylene Pump Housing & Valve Plate	
8 Max Amps	Zinc Plated Steel Fasteners	
4.8 lbs Dry	Self Priming to 8'	
CE Approved	Painted Steel 3" Motor Shell	
	140° F Max Temperature Rating	

PUMPS

DIAPHRAGM PUMP ^{1.0 GPM} HOSE BARB PORTS



Part#	Port Type	Packaging
EF1000	3/8" Hose Barb	Bulk
EF1000-BC	3/8" Hose Barb	Barcoded
EF1000-BOX	3/8" Hose Barb	Boxed

1.0 GPM pumps are not user serviceable.

FEATURES

40 PSI	Polypropylene Pump Housing & Valve Plate
13 Max Amps	Zinc Plated Steel Fasteners
1.3 lbs Dry	Self Priming to 4'
CE Approved	Painted Steel 2" Motor Shell
	140° F Max Temperature Rating

DIAPHRAGM PUMP ^{2.2 GPM} NPT OR QA PORTS



Part#	Port Type	Packaging
EF2200-QA	Quick Attach	Bulk
EF2200-QA-BOX	Quick Attach	Boxed
EF2200	3/8" FNPT	Bulk
EF2200-BC	3/8" FNPT	Barcoded
EF2200-BOX	3/8" FNPT	Boxed
EF2200-QA-KIT	Replacement Head Kit for EF2200-QA	
EF2200-KIT	Replacement Pump Head Kit for EF2200	

FEATURES

70 PSI	Polypropylene Pump Housing & Valve Plate
8 Max Amps	Zinc Plated Steel Fasteners
4.8 lbs Dry	Self Priming to 8'
CE Approved	Painted Steel 3" Motor Shell
	140° F Max Temperature Rating

DIAPHRAGM PUMP ^{3.0 GPM} NPT OR QA PORTS



Part#	Port Type	Packaging
EF3000-QA	Quick Attach	Bulk
EF3000-QA-BOX	Quick Attach	Boxed
EF3000	1/2" FNPT	Bulk
EF3000-BC	1/2" FNPT	Barcoded
EF3000-BOX	1/2" FNPT	Boxed
EF3000-QA-KIT	Replacement Head Kit for EF3000-QA	
EF3000-KIT	Replacement Head Kit for EF3000	

FEATURES

60 PSI	Polypropylene Pump Housing & Valve Plate
10 Max Amps	Zinc Plated Steel Fasteners
5.6 lbs Dry	Self Priming to 12'
CE Approved	Painted Steel 3" Motor Shell
	140° F Max Temperature Rating

DIAPHRAGM PUMP ^{4.0 GPM} NPT OR QA PORTS



Part#	Port Type	Packaging
EF4000-QA	Quick Attach	Bulk
EF4000-QA-BOX	Quick Attach	Boxed
EF4000	1/2" FNPT	Bulk
EF4000-BC	1/2" FNPT	Barcoded
EF4000-BOX	1/2" FNPT	Boxed
EF4000-QA-KIT	Replacement Head Kit for EF4000-QA	
EF4000-KIT	Replacement Head Kit for EF4000	

FEATURES

60 PSI	Polypropylene Pump Housing & Valve Plate
13 Max Amps	Zinc Plated Steel Fasteners
5.6 lbs Dry	Self Priming to 12'
CE Approved	Painted Steel 3" Motor Shell
	140° F Max Temperature Rating

EVERFLO

PUMPS

5.5 GPM

DIAPHRAGM PUMP

NPT OR QA PORTS



Part#	Port Type	Packaging
EF5500-QA	Quick Attach	Bulk
EF5500-QA-BOX	Quick Attach	Boxed
EF5500	1/2" FNPT	Bulk
EF5500-BC	1/2" FNPT	Barcoded
EF5500-BOX	1/2" FNPT	Boxed
EF5500-QA-KIT	Replacement Head Kit for EF5500-QA	
EF5500-KIT	Replacement Head Kit for EF5500	

FEATURES

60 PSI	Polypropylene Pump Housing & Valve Plate
17 Max Amps	Zinc Plated Steel Fasteners
5.6 lbs Dry	Self Priming to 12'
CE Approved	Painted Steel 3" Motor Shell
	140° F Max Temperature Rating

7.0 GPM

DIAPHRAGM PUMP

NPT OR QA PORTS



Part#	Port Type	Packaging
EF7000-QA-BOX	Quick Attach	Bulk
EF7000-BOX	1/2" FNPT	Boxed
EF7000-QA-KIT	Replacement Head Kit for EF7000-QA	
EF7000-KIT	Replacement Head Kit for EF7000	

FEATURES

60 PSI	Polypropylene Pump Housing & Valve Plate
23 Max Amps	Zinc Plated Steel Fasteners
9.5 lbs Dry	Self Priming to 12'
CE Approved	Painted Steel 5" Motor Shell
	140° F Max Temperature Rating

1.5 GPM HIGH PRESSURE

DIAPHRAGM PUMP

NPT OR QA PORTS



Part#	Port Type	Packaging
EFHP1515QA-BOX	Quick Attach	Boxed
EFHP1515-BOX	3/8" FNPT	Boxed

FEATURES

150 PSI	Self Priming to 8'
10.5 Max Amps	Auto Shut-Off
5.0 lbs Dry	140° F Max Temperature Rating
CE Approved	

2.0 GPM HIGH PRESSURE

DIAPHRAGM PUMP

QA PORTS



Part#	Description
EFHP2000-BOX	2.0 GPM 12V Plunger Pump - Boxed

FEATURES

200 PSI	Ceramic Coated Plunger
20 Max Amps	Auto Shut-Off
13 lbs Dry	QA Ports Only
CE Approved	Includes 6 Common Fittings
	140° F Max Temperature Rating

HOSE & ACCESSORIES

CUSTOMIZABLE VALVE BANKS



Part#	Description
G-8372C0070	A variety of sizes and style Valve Banks are available to control individual sections of large booms independently. Call for details.

RUBBER HOSE CLAMSHELLED



Part#	Description
38RUB15-CSK	15' of 3/8" Hose with Clamshell Packaging
33-103622	Bulk 1/2" Hose

HIGH PRESSURE HOSE



Part #	Length	Pressure	Size
33-103321-150FT	150'	600 PSI Max	1/2"
33-103321-200FT	200'		
33-103321-300FT	300'		

NYLON HOSE CLEAR



Part#	Inner Diameter	Outer Diameter
33-103938	.37"	.59"

BYPASS KIT



Part#	Description
34-140028-CSK	Bypass Kit includes two-way shut off valve, hose and connections

HOSE REPAIR KIT HBxHB



Part#	Description
34-140024-CSK	Features 3/8" hose barbs and connection to mend damaged hose

HOSE ACCESSORIES

SET SCREW COUPLER STEEL



Part#

50101-1

FEATURES

Fits 4 Roller Pump For 5/8" Diameter Motors
2600 RPM Max Steel Construction

GHT SHUT-OFF VALVE NYLON



Part#

Connection Size

GHV-1-BLK 3/4 FGHT (inlet) x 3/4 MGHT (1 outlet)
GHV-1-BLK-CSK Same As GHV-1-BLK, Clamshelled
GHV-1-BLK-BG Bagged

FEATURES

60 PSI maximum operating pressure
Black nylon construction

GARDEN HOSE WASHERS VINYL



W406V

10373

Part#

OD x ID

W406V
10373

1 x 3/4
1 x 3/4

GHT SHUT-OFF Y-VALVE NYLON



Part#

Connection Size

GHV-2-BLK 3/4 FGHT (inlet) x 3/4 MGHT (2 outlets)
GHV-2-BLK-BG Bagged

FEATURES

60 PSI maximum operating pressure
Black nylon construction

QUICK CONNECT COUPLERS ALUMINUM



Part#

Roller Size

Shaft Size

46814-1-BC
46814-3-BC

4
6

5/8"
5/16"

FEATURES

PTO 1 3/8" Die Cast Aluminum
9 Tooth 540-1000 RPM

TANK ACCESSORIES

LIDS & BASKETS STANDARD FOR SPRAYER TANKS

TANK LIDS		
Part #	Diameter	Style
33-103221	5"	Closed
34-140030-CSK	5"	Closed - With Lanyard
G-8140000	6"	Closed
G-8140002	6"	Vented
G-8178000	6"	Closed - Female
G-8178001	6"	Vented - Female
TL-6B	6"	Breather - Female
TL-6B-BC	6"	Breather - Female - Barcoded
TL-6B-W/GAS	6"	Breather - Female - With Gasket
G-8146000	8"	Closed
G-8146000-BC	8"	Closed - Barcoded
G-8146002	8"	Vented
G-8149001	8"	Closed -With Ring
G-8152000	12"	Closed
G-8152002	12"	Vented
G-8155000	12"	Vented - With Ring
G-8169014	12"	Vented - With Hinge
G-8158000	16"	Closed
G-8158002	16"	Vented
G-8158002-BC	16"	Vented - Barcoded
G-8161000	16"	2 Maze Vents - With Ring
G-8170015	18"	180° Opening - Floating Ball Vent Valve

LID RINGS		
Part #	Diameter	With Gasket
G-8142000	6"	
G-8148000	8"	
G-8148002	8"	Yes
G-8154000	12"	
G-8154002	12"	Yes
G-8160000	16"	
G-8160002	16"	Yes

LID GASKETS		
Part #	Diameter	Material
TL-6B-GAS	6"	EPDM
G-G00000014	16"	EPDM

LID STRAINER BASKETS		
Part #	Diameter	Depth
G-8147001	5"	5"
TLS-5D	5"	1.5"
TLS-5D-CSK	5"	1.5"
G-8147002	8"	9.5"
G-8153001	12"	9.5"
G-8159000	16"	7"
G-8159001	16"	11"



TLS-5D



TL-6B



G-8158002



G-8160000



G-8159001

POLYPROPYLENE BULK HEAD FITTINGS



Part#	FNPT	Hole Size	Gasket Only
BHF12	1/2"	1 3/4"	BHF12/34GAS
BHF12-BC	1/2"	1 3/4"	**
BHF34	3/4"	1 3/4"	BHF12/34GAS
BHF34-BC	3/4"	1 3/4"	**
BHF100	1"	2 1/8"	BHF100GAS
BHF100-BC	1"	2 1/8"	**
BHF114	1 1/4"	2 5/8"	BHF114/112GAS
BHF112	1 1/2"	2 5/8"	BHF114/112GAS
BHF112-BC	1 1/2"	2 5/8"	**
BHF200	2"	3 1/4"	BHF200GAS
BHF200-BC	2"	3 1/4"	**
BHF300	3"	4 3/8"	BHF300GAS
BHF400	4"	5 5/8"	BHF400GAS

** -BC Suffix Denotes Product is Offered with Barcoding

BOOMLESS NOZZLES



LEFT & RIGHT PATTERN BOOMLESS NOZZLES

Available in left or right spray patterns. Provides a directional spray pattern for overlap coverage when mounted in pairs. Ideal mounting heights between 24"-48". Clamshelled options include a 1/4" x 11/16" female adapter.

Part#	Pattern	GPM	Orifice Size	Thread Size	Swath
BN2BP088LSX-CS	Left	2	.088	1/4" MNPT	8'
BN2BP088LSX	Left	2	.088	1/4" MNPT	8'
BN2BP088RSX-CS	Right	2	.088	1/4" MNPT	8'
BN2BP088RSX	Right	2	.088	1/4" MNPT	8'
BN2BP116LSX-CS	Left	3	.116	1/4" MNPT	11'
BN2BP116LSX	Left	3	.116	1/4" MNPT	11'
BN2BP116RSX-CS	Right	3	.116	1/4" MNPT	11'
BN2BP116RSX	Right	3	.116	1/4" MNPT	11'



FULL PATTERN BOOMLESS NOZZLES

Available in various spray distance values. Deliver a full spray pattern. Designed for wide band spray applications from a single mounted nozzle. Spray distance value at 36" mounted height. Mounting height 24-48". All wide pattern boomless nozzles are two piece construction.

Part#	Pattern	GPM	Orifice Size	Thread Size	Swath	Construction
BN2BP125FWX-CS	Full	2	.125	1/4" MNPT	16'	Brass Cap & Poly Body, Clamshelled
BN2BP125FWX	Full	2	.125	1/4" MNPT	16'	Brass Cap & Poly Body, Bulk
BN2BP152FWX-CS	Full	3	.152	1/4" MNPT	22'	Brass Cap & Poly Body, Clamshelled
BN2BP152FWX	Full	3	.152	1/4" MNPT	22'	Brass Cap & Poly Body, Bulk

BOOMLESS NOZZLES ALL-BRASS



DESCRIPTION

Made with all brass for increased durability. Nozzles can deliver a half or full spray pattern up to 58'. Ideal mounting heights between 24"-48". Clamshelled options include a 1/2" MNPT x 3/8" FNPT reducer bushing.

Part#	Pattern	GPM	Orifice	Swath
BN6540-01	Full & Half	1.7-2.4	#5	44-50'
BN6541-01	Full & Half	3.7-5.0	#10	50-52'
BN6542-01	Full & Half	5.1-7.1	#20	54-58'
6540-01-CSK	Full & Half	1.7-2.4	#5	44-50'
6541-01-CSK	Full & Half	3.7-5.0	#10	50-52'
6542-01-CSK	Full & Half	5.1-7.1	#20	54-58'

RETAIL CLAMSHELL PACKAGING



All nozzles are available packed in retail-ready clamshells with full-color, fold-open informational card inserts.

ACCESSORIES

STRAINERS, NOZZLE BODY KITS & CHEMICAL PROTECTION

NOZZLE STRAINERS

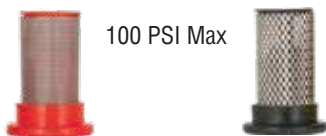

100 PSI Max

Part#	Description
NS-50	50 Mesh - Red
NS-50-CSK	50 Mesh - Red (4 Pack)
NS-50-BC	50 Mesh w/ Ball Check - Red
NS-50-BC-CSK	50 Mesh w/ Ball Check - Red (4 Pack)
NS-100	100 Mesh - Black
NS-100-CSK	100 Mesh - Black (4 Pack)
NS-100-BC	100 Mesh w/ Ball Check - Black
NS-100-BC-CSK	100 Mesh w/Ball Check - Black (4 Pack)

CHEMICAL PROTECTION



Part#	Description
CHEM-GLOVE-L	Chemical Resistant Nitrile Gloves, Lg
CHEM-GOGGLE	Chemical Resistant Safety Goggles

POLYPROPYLENE ELBOW NOZZLE BODY KITS



Part#	Connection Size
34-140025BLK-CSK	3/8" HB x 11/16" MNPT
34-140043BLK-CSK	1/2" HB x 11/16" MNPT

POLYPROPYLENE TEE NOZZLE BODY KITS



Part#	Connection Size
34-140026BLK-CSK	3/8" HB x 11/16" MNPT
34-140047BLK-CSK	1/2" HB x 11/16" MNPT

POLYPROPYLENE CROSS NOZZLE BODY KITS



Part#	Connection Size
34-140027BLK-CSK	3/8" HB x 11/16" MNPT
34-140044BLK-CSK	1/2" HB x 11/16" MNPT

NYLON ELBOW NOZZLE BODY KITS



Part#	Connection Size
34-140025-CSK	3/8" HB x 11/16" MNPT
34-140043-CSK	1/2" HB x 11/16" MNPT

NYLON TEE NOZZLE BODY KITS



Part#	Connection Size
34-140026-CSK	3/8" HB x 11/16" MNPT
34-140047-CSK	1/2" HB x 11/16" MNPT

NYLON CROSS NOZZLE BODY KITS



Part#	Connection Size
34-140027-CSK	3/8" HB x 11/16" MNPT
34-140044-CSK	1/2" HB x 11/16" MNPT

SPRAY NOZZLES

& COVERAGE CHARTS

SPRAY NOZZLE CHARTS



RETAIL PACKAGING

Packed in retail-ready clamshell with fold-open informational card insert.

ALSO AVAILABLE IN BULK.



FLAT FAN NOZZLES

80°/110°

DESIGNED FOR GENERAL SPRAYING

Economical tip for general spraying.
Medium drop size with medium drift hazard.
Best performance between 30-60 PSI.
20" & 28" suggested spray height.



80° Part#	Color
90.080.002-CSK	Yellow
90.080.003-CSK	Blue
90.080.004-CSK	Red
90.080.005-CSK	Brown
90.080.006-CSK	Gray
90.080.008-CSK	White
110° Part#	Color
90.110.002-CSK	Yellow
90.110.003-CSK	Blue
90.110.004-CSK	Red

Part#	PSI	Capacity Per Nozzle		Gallons/Acre							
		GPM	Oz/Min	4MPH	5MPH	6MPH	7MPH	8MPH	9MPH	10MPH	12MPH
90.080.002-CSK 90.110.002-CSK	30	0.17	22.0	12.6	10.1	8.4	7.2	6.3	5.6	5.0	4.2
	40	0.20	26.0	14.9	11.9	9.9	8.5	7.4	6.6	5.9	5.0
	50	0.22	28.0	16.3	13.1	10.9	9.3	8.2	7.3	6.5	5.4
	60	0.24	31.0	17.8	14.3	11.9	10.2	8.9	7.9	7.1	5.9
90.080.003-CSK 90.110.003-CSK	75	0.27	34.8	20.0	16.1	13.4	11.5	10.0	8.9	8.0	6.6
	30	0.26	33.0	19.3	15.4	12.9	11.0	9.7	8.6	7.7	6.4
	40	0.30	38.0	22.0	17.8	14.9	12.7	11.1	9.9	8.9	7.4
	50	0.34	44.0	25.0	20.0	16.8	14.4	12.6	11.2	10.1	8.4
90.080.004-CSK 90.110.004-CSK	60	0.37	47.0	27.0	22.0	18.3	15.7	13.7	12.2	11.0	9.2
	75	0.42	52.9	30.4	24.8	20.6	17.7	15.4	13.7	12.4	10.4
	30	0.35	45.0	26.0	21.0	17.3	14.9	13.0	11.6	10.4	8.7
	40	0.40	51.0	30.0	24.0	19.8	17.0	14.9	13.2	11.9	9.9
90.080.005-CSK	50	0.45	58.0	33.0	27.0	22.0	19.1	16.7	14.9	13.4	11.1
	60	0.49	63.0	36.0	29.0	24.0	21.0	18.2	16.2	14.6	12.1
	75	0.55	70.7	40.4	32.6	27.0	23.6	20.4	18.2	16.4	13.6
	30	0.43	55.0	32.0	26.0	21.0	18.2	16.0	14.2	12.8	10.6
90.080.006-CSK	40	0.50	64.0	37.0	30.0	25.0	21.0	18.6	16.5	14.9	12.4
	50	0.56	72.0	42.0	33.0	28.0	24.0	21.0	18.5	16.6	13.9
	60	0.61	78.0	45.0	36.0	30.0	26.0	23.0	20.0	18.1	15.1
	75	0.67	86.0	49.6	39.7	33.1	28.7	25.4	22.1	20.0	16.7
90.080.008-CSK	30	0.43	55.0	32.0	26.0	21.0	18.2	16.0	14.2	12.8	10.6
	40	0.50	64.0	37.0	30.0	25.0	21.0	18.6	16.5	14.9	12.4
	50	0.56	72.0	42.0	33.0	28.0	24.0	21.0	18.5	16.6	13.9
	60	0.61	78.0	45.0	36.0	30.0	26.0	23.0	20.0	18.1	15.1
90.080.008-CSK	75	0.67	86.0	49.6	39.7	33.1	28.7	25.4	22.1	20.0	16.7
	30	0.69	88.0	51.0	41.0	34.0	29.0	26.0	23.0	20.0	17.1
	40	0.80	102.0	59.0	48.0	40.0	34.0	30.0	26.0	24.0	19.8
	50	0.89	114.0	66.0	53.0	44.0	38.0	33.0	29.0	26.0	22.0
90.080.008-CSK	60	0.98	125.0	73.0	58.0	49.0	42.0	36.0	32.0	29.0	24.0
	75	1.09	140.0	81.8	65.0	54.9	47.0	40.3	35.8	32.5	26.9

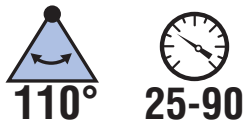

LARGER DROPLETS TO CUT DRIFT

Delivers larger droplets and greatly reduces drift compared to standard. Medium drop size with low drift hazard. Best performance between 25-90 PSI. 20" suggested spray height.

AIR INDUCTION NOZZLES 110°



110° Air Induction Nozzles	PSI	Capacity Per Nozzle		Gallons/Acre 20" Spacing						
		GPM	Oz/Min	4MPH	5MPH	6MPH	8MPH	10MPH	12MPH	15MPH
G-8259492-CSK	30	0.17	22	12.6	10.1	8.4	6.3	5	4.2	3.4
	40	0.2	26	14.9	11.9	9.9	7.4	5.9	5	4
	50	0.22	28	16.3	13.1	10.9	8.2	6.5	5.4	4.4
	60	0.24	31	17.8	14.3	11.9	8.9	7.1	5.9	4.7
	75	0.27	35	20	16	13.4	10	8	6.7	5.3
G-8259493-CSK	90	0.3	38	22	17.8	14.9	11.1	8.9	7.4	5.9
	30	0.22	28	16.3	13.1	10.9	8.2	6.5	5.4	4.4
	40	0.25	32	18.6	14.9	12.4	9.3	7.4	6.2	5
	50	0.28	36	21	16.6	13.9	10.4	8.3	6.9	5.5
	60	0.31	40	23	18.4	15.3	11.5	9.2	7.7	6.1
G-8259494-CSK	75	0.34	44	25	20	16.8	12.6	10.1	8.4	6.7
	90	0.38	49	28	23	18.8	14.1	11.3	9.4	7.5
	30	0.26	33	19.3	15.4	12.9	9.7	7.7	6.4	5.1
	40	0.3	38	22	17.8	14.9	11.1	8.9	7.4	5.9
	50	0.34	44	25	20	16.8	12.6	10.1	8.4	6.7
G-8259495-CSK	60	0.37	47	27	22	18.3	13.7	11	9.2	7.3
	75	0.41	52	30	24	20	15.2	12.2	10.1	8.1
	90	0.45	58	33	27	22	16.7	13.4	11.1	8.9
	30	0.35	45	26	21	17.3	13	10.4	8.7	6.9
	40	0.4	51	30	24	19.8	14.9	11.9	9.9	7.9
G-8259496-CSK	50	0.45	58	33	27	22	16.7	13.4	11.1	8.9
	60	0.49	63	36	29	24	18.2	14.6	12.1	9.7
	75	0.55	70	41	33	27	20	16.3	13.6	10.9
	90	0.6	77	45	36	30	22	17.8	14.9	11.9
	30	0.43	55	32	26	21	16	12.8	10.6	8.5
G-8259497-CSK	40	0.5	64	37	30	25	18.6	14.9	12.4	9.9
	50	0.56	72	42	33	28	21	16.6	13.9	11.1
	60	0.61	78	45	36	30	23	18.1	15.1	12.1
	75	0.68	87	50	40	34	25	20	16.8	13.5
	90	0.75	96	56	45	37	28	22	18.6	14.9
G-8259557-CSK	30	0.52	67	39	31	26	19.3	15.4	12.9	10.3
	40	0.6	77	45	36	30	22	17.8	14.9	11.9
	50	0.67	86	50	40	33	25	19.9	16.6	13.3
	60	0.73	93	54	43	36	27	22	18.1	14.5
	75	0.82	105	61	49	41	30	24	20	16.2
90	0.9	115	67	53	45	33	27	22	17.8	

Part#	Color
G-8259492-CSK	Yellow
G-8259493-CSK	Purple
G-8259494-CSK	Blue
G-8259495-CSK	Red
G-8259557-CSK	Gray

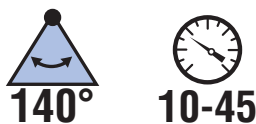

LARGER DROPLETS, CLOG RESISTANT

Deflecting design creates wide angle spray. Larger orifice for clog resistance. Best performance between 10-45 PSI. Medium drop size with low drift hazard. 20" suggested spray height.

DEFLECTOR NOZZLES 140°



Part#	PSI	Capacity Per Nozzle		Gallons/Acre							
		GPM	Oz/Min	30" Spacing				40" Spacing			
				5MPH	6MPH	7MPH	8MPH	5MPH	6MPH	7MPH	8MPH
DF2.0-CSK	10	0.20	26	7.9	6.6	5.7	5.0	5.9	5.0	4.2	3.7
	20	0.28	36	11.1	9.2	7.9	6.9	8.3	6.9	5.9	5.2
	30	0.35	45	13.9	11.6	9.9	8.7	10.4	8.7	7.4	6.5
	40	0.40	51	15.8	13.2	11.3	9.9	11.9	9.9	8.5	7.4
DF2.5-CSK	10	0.25	32	9.9	8.3	7.1	6.2	7.5	6.2	5.3	4.7
	20	0.36	46	14.0	11.5	10.0	8.8	10.5	8.8	7.6	6.6
	30	0.44	56	17.0	14.5	12.5	11.0	13.0	11.0	9.3	8.1
	40	0.50	64	20.0	16.5	14.0	12.5	15.0	12.5	10.5	9.3
DF3.0-CSK	10	0.30	39	11.9	9.9	8.6	7.5	8.9	7.5	6.3	5.6
	20	0.42	54	16.7	13.8	11.9	10.4	12.5	10.4	8.9	7.8
	30	0.53	68	20.9	17.4	14.9	13.1	15.6	13.1	11.1	9.8
	40	0.60	77	23.7	19.8	17.0	14.9	17.9	14.9	12.8	11.1
DF4.0-CSK	10	0.40	52	15.8	13.2	11.4	10.0	11.8	10.0	8.4	7.4
	20	0.56	72	22.2	18.4	15.8	13.8	16.6	13.8	11.8	10.4
	30	0.70	90	27.8	23.2	19.8	17.4	20.8	17.4	14.8	13.0
	40	0.80	102	32	26.4	22.6	19.8	23.8	19.8	17.0	14.8
DF5.0-CSK	10	0.50	64	20	16.5	14.1	12.4	14.9	12.4	10.6	9.3
	20	0.71	91	28	23	20	17.6	21	17.6	15.1	13.2
	30	0.87	111	34	29	25	22	26	22	18.5	16.1
	40	1.00	128	40	33	28	25	30	25	21.0	18.6
DF7.5-CSK	10	0.75	96	30	25	21	19	22	19	15.9	14.0
	20	1.07	137	42	35	30	26	32	26	23	19.8
	30	1.31	167	51	44	38	33	39	33	28	24
	40	1.50	192	60	50	42	38	45	38	32	28
DF10.0-CSK	10	1.00	128	40	33	28	25	30	25	21	19
	20	1.42	182	56	46	40	35	42	35	30	26
	30	1.74	222	68	58	50	44	52	44	37	32
	40	2.00	256	80	66	56	50	60	50	42	37

Part#	Color
DF2.0-CSK	Red
DF2.5-CSK	Brown
DF3.0-CSK	Gray
DF4.0-CSK	White
DF5.0-CSK	Blue
DF7.5-CSK	Green
DF10.0-CSK	Black

ADAPTERS & PLUMBING

INLET STRAINER



Part#	Connection Size	Packaging
33-103121	3/8" HB	Bulk
33-103121-CSK	3/8" HB	Clamshelled
33-103122	1/2" HB	Bulk
33-103122-BC	1/2" HB	Barcoded

MANIFOLD



Part#	Description
34-140068-CSK	Manifold with 1/4" Gauge Port

PRESSURE VARIABLE REGULATOR



Part#	Description
34-140118	Sprayer Regulator w/QC Adapter - Bulk
34-140118-CSK	Sprayer Regulator w/QC Adapter - Clamshelled
34-140162	200 PSI Sprayer regulator w/QC Adapter

QUICK CONNECT FITTINGS 4-PIECE KIT



Part#	Description
EF-QC-KIT1	Add Quick Connect Ports to Most Manufacturer's 12 Volt Diaphragm Pumps

ON/OFF VALVE UNIVERSAL



Part#	Connection Size
34-140141	Male QC x Female QC - Bulk
34-140141-CSK*	Male QC x Female QC - Clamshelled

*Includes QC x 3/4" MGHT & QC x 3/8" Hose Barb Adapters

QUICK CONNECT FITTINGS



Part#	Type	Connection Size
EF-QC-M12	Adapter	1/2" MNPT x QC
EF-QC-E34	Adapter	3/4" MGHT x QC
EF-QC-FQA/M38	Adapter	3/8" MNPT x Female QC
EF-QC-A38	Hose Barb	3/8" HB x QC
EF-QC-A12	Hose Barb	1/2" HBx QC
EF-QC-A34	Hose Barb	3/4" HB x QC
EF-QC-EL38	Elbow	3/8" HB x QC
EF-QC-EL12	Elbow	1/2" HB x QC
EF-QC-50EL12	50° Elbow	1/2" HB x QC
EF-QC-EL34	Elbow	3/4" x QC

** Add -CSK suffix for clamshell retail packaging.

SPRAYER

ACCESSORIES

DRAIN CAP KIT



Part#	Includes
34-140007	Drain Plug Cap, Drain Plug Cap Tether, Drain Plug Gasket

SPOT SPRAYER REPLACEMENT KIT



Part#	Includes
34-140029-CSK	Replace common wear items with this kit. Includes: (2) Spray Gun Mounting Clips, (1) Drain Plug Cap with Tether, (1) 3/8" Hose Barb x 3/8" MPT for Connecting Hose to Pump

INLINE STRAINER CLEAR BOWL



Part#	Connection Size	Packaging
34-140164	1/2" HB x Quick Attach	Bulk
34-140164-CSK	1/2" HB x Quick Attach	Clamshelled

HOOK & LOOP HOSE STRAP



Part #	Features
HOSE-STRAP-CSK	Organizes spray gun hose. Includes self-tapping screw. Installs on most manufacturer's tanks.

NEW

MEASURING PITCHERS POLYPROPYLENE

APPLICATIONS

- Industrial
- Agriculture
- Automotive
- Lawn Care
- Household



Chemical resistant polypropylene measuring pitchers featuring an ergonomic handle and black, debossed graduations.

Part#	Size
MP-08	8oz / 250ml
MP-16	16oz / 500ml
MP-32	32oz / 1000ml
MP-64	64oz / 2000ml

HOSE CLAMPS

WORM GEAR HOSE CLAMPS STEEL



Series#	Description
300, 600	Stainless steel band & housing, plated screw
350, 620	Stainless steel band, housing & screw

5/16" Band		
Part#	Size	Packaging
300-004-CSK	1/4"	Clamshelled
350-004	1/4"	
350-005	9/16"	
300-006	3/8"	
300-006-CSK	3/8"	Clamshelled
350-006	3/8"	
350-008	1/2"	
350-010	5/8"	
350-012	3/4"	
350-016	1"	
1/2" Band		
620-006	3/8"	
620-008	1/2"	
620-010	5/8"	
600-012-CSK	3/4"	Clamshelled
620-012	3/4"	
620-016	1"	
600-020-CSK	1 1/4"	Clamshelled
620-020	1 1/4"	

1/2" Band (continued)		
Part#	Size	Packaging
620-024	1 1/2"	
620-028	1 3/4"	
620-032	2"	
620-036	2 1/4"	
620-040	2 1/2"	
620-044	2 3/4"	
620-048	3"	
620-052	3 1/4"	
620-056	3 1/2"	
620-060	3 3/4"	
600-064	4"	
600-064-CSK	4"	Clamshelled
620-064	4"	
620-072	4 1/2"	
620-080	5"	
620-088	5 1/2"	
620-096	6"	
620-104	6 1/2"	
620-128	8"	

SNAPPER HOSE CLAMPS PLASTIC



Features

Double Tooth Locking System



* -CSK are Clamshelled 6 Packs

Part#	Fits	Min Diameter	Max Diameter
SHC-A		0.228"	0.356"
SHC-AA		0.256"	0.319"
SHC-B		0.311"	0.378"
SHC-BB		0.351"	0.394"
SHC-C		0.402"	0.485"
SHC-D	1/4" Hose	0.449"	0.511"
SHC-D-CSK	1/4" Hose	0.449"	0.511"
SHC-E		0.516"	0.619"
SHC-F	3/8" Hose	0.616"	0.707"
SHC-F-CSK*	3/8" Hose	0.616"	0.707"
SHC-G		0.666"	0.784"
SHC-H		0.702"	0.801"
SHC-J	1/2" Hose	0.779"	0.899"
SHC-J-CSK*	1/2" Hose	0.779"	0.899"
SHC-K		0.900"	1.000"
SHC-L		0.985"	1.135"
SHC-M	3/4" Hose	1.044"	1.198"
SHC-M-CSK*	3/4" Hose	1.044"	1.198"
SHC-N		1.123"	1.296"
SHC-P		1.261"	1.403"
SHC-Q		1.351"	1.525"
SHC-R		1.338"	1.566"
SHC-V		1.730"	2.010"

BOOM

ACCESSORIES

NOZZLE BODY BOOM CLAMPS SQUARE



Part#	Size	Type	Packaging
BCS-100	1"	Standard	Bulk
BCS-100-CSK	1"	Standard	Clamshelled
BCS-114-CSK	1¼"	Standard	Clamshelled
G-8235037	¾"	Vari-Space	Bulk
G-8235037-CSK	¾"	Vari-Space	Clamshelled
G-8235039	1"	Vari-Space	Bulk
G-8235039-CSK	1"	Vari-Space	Clamshelled
G-8235041	1¼"	Vari-Space	Bulk
G-8235041-CSK	1¼"	Vari-Space	Clamshelled
G-8235043	1½"	Vari-Space	Bulk
G-8235043-CSK	1½"	Vari-Space	Clamshelled

NOZZLE BODY BOOM CLAMPS ROUND



Part#	Size	Type	Packaging
BCR-34	¾"	Standard	Bulk
BCR-34-CSK	¾"	Standard	Clamshelled
BCR-100	1"	Standard	Bulk
BCR-100-CSK	1"	Standard	Clamshelled
G-8235036	¾"	Vari-Space	Bulk
G-8235036-CSK	¾"	Vari-Space	Clamshelled
G-8235038	1"	Vari-Space	Bulk
G-8235038-CSK	1"	Vari-Space	Clamshelled

DIAPHRAGM CHECK NOZZLE BODIES ELBOW & TEE



Part#	Type	Connection Size
4240N-B1215	Elbow	3/8" HB x QA
G-8235021	Elbow	1/2" HB x QA
G-8235023	Elbow	3/4" HB x QA
G-8235025	Tee	3/8" HB x QA
G-8235027	Tee	1/2" HB x QA
G-8235029	Tee	3/4" HB x QA

Add -CSK Suffix for Retail Clamshell

NO CHECK NOZZLE BODIES ELBOW, TEE & CROSS



Part#	Type	Connection Size
34-400008	Elbow	3/8" HB x QA
G-8231003	Elbow	1/2" HB x QA
G-8231005	Elbow	3/4" HB x QA
34-400009	Tee	3/8" HB x QA
G-8231009	Tee	1/2" HB x QA
G-8231011	Tee	3/4" HB x QA
G-8231013	Cross	3/8" HB x QA

Add -CSK Suffix for Retail Clamshell

NOZZLE ACCESSORIES

CHECK VALVE NOZZLE HOLDERS



Part#	Description
G-8234037	1/4" NPT F Nozzle Holder
G-8234040-8	1/4" FNPT x 1/4" MNPT
G-8234043-CSK	Check Valve

NOZZLE SWIVEL



Part#	Connection Size
G-8247015-CSK	1/4" FNPT

NOZZLE CAPS QUICK ATTACH



Part#	Color	Nozzle Style
34-140042-CSK	Yellow	Flat Fan
G-8253000-CSK	Red	Flat Fan
G-8253051-CSK	Black	Deflector

NOZZLE CAP SHUT-OFF



Part#	Features
G-8253040-CSK	Replacement for Master MFG spray boom SSBK-PNB.

FPTxQA ADAPTER



Part#	Connection Size
G-8230021-CSK	1/4" FNPT

GASKET & DIAPHRAGM EPDM



Part#	Type	Qty
G-M00100000-CSK	Diaphragm	12
G-00002020-CSK	Gasket	12

NOZZLE CAPS FNPT



Part#	Connection Size	Color
G-8253048-CSK	1/4" FNPT	Black

NOZZLE BODY QUICK CLIP NYLON



Part#	FEATURES
31-400010-CSK	Replacement for Master MFG spray booms Comes in four pack

NYLON DROP HOSE



Part#	Length
G-8251000-CSK	15"
G-8251002-CSK	24"

BULK TANKS

15 GALLON



Part#	Color	Features
T-015-WWNA-XL	White	Standard
T-015-YYNA-XL	Yellow	Standard
Dimensions: 15" x 35" x 15"		

25 GALLON



Part#	Color	Features
T-025-WWNA-XL	White	Standard
T-025-YYNA-XL	Yellow	Standard
Dimensions: 19" x 36.5" x 15"		

40 GALLON



Part#	Color	Sump
T-040-WWNA-XL	White	No
T-040-WWSA-XL	White	Yes
T-040-YYNA-XL	Yellow	No
T-040-YYSA-XL	Yellow	Yes
Dimensions: 24" x 37" x 26.25"		

60 GALLON



Part#	Color	Sump
T-060-WWNA-XL	White	No
T-060-WWSA-XL	White	Yes
T-060-YYNA-XL	Yellow	No
T-060-YYSA-XL	Yellow	Yes
Dimensions: 36" x 24" x 24"		

- 15, 25, 40 and 60 Gallon Capacities
- Chemical Resistant Polyethylene Construction
- Mold-in Drain Port with Tethered Cap
- Translucent Tank Walls for Viewing Fluid Levels
- Glyphosate Compatible
- Standard Pump & Component Mount Inserts
- Tethered, Screw-on Fill Lid
- UV Stabilized Colors

Other color options available. Minimum Order Quantities required.

BULK TANK FEATURES

WIRE HARNESSSES & SPRAY GUN REPAIR KITS

WIRE HARNESS WITH CLAMPS



Part#	Length	Gauge	Amps
33-103233	10'	16	7
33-103233-CSK	10'	16	7

WIRE HARNESS WITH DC PLUG



Part#	Length	Gauge	Amps
33-103260	8'	18	7
33-103260-CSK	8'	18	7

HEAVY DUTY WIRE HARNESS WITH CLAMPS



Part#	Length	Gauge	Amps
33-103351	8'	12	20
33-103351-CSK	8'	12	20

WIRE HARNESS EXTENSION



Part#	Length	Gauge	Amps
WHE-14-72-CSK	6'	14	20

SPRAY GUN REPAIR KIT 1700 SERIES



Part#	Repair Kit
SG-1700-NZLKIT	Spray Nozzle
SG-1700-INTKIT	Gun Internals
SG-1700-TRGKIT	Gun Trigger

SPRAY GUN REPAIR KIT 2200 SERIES



Part#	Compatible Spray Guns
SG-2200KIT-CSK	SG-2200

REPLACEMENT SPRAY TIPS



Part#	Compatible Spray Guns
SG-45ASSY-18	SG-4507F, SG-500T
SG-45ASSY-18-CSK	SG-4507F, SG-500T
SG-4200TIP-CSK	SG-4200

SPRAY GUN MOUNTING KITS



Part#	Description
GC-100-KIT	Includes Two Clips, & Two 10-24 x 1/2" Machine Screws
GC-100	Sam as above, bulk.
GC-2255	Clip to Hold 3/8-5/8" Diameter Gun Lances

-CSK suffix denotes retail-ready clamshell packaging.

SPRAY GUNS

SPRAY GUN ^{SPOT} ADJUSTABLE



Part#

SG-4200-18
SG-4200-18-CB

FEATURES

Ideal for up to 100 PSI & 2.2 GPM #18 orifice
Trigger lock for continuous use Filter in handle
30" overall length 3/8" hose barb inlet

Compatible Replacement Parts

GC-100	GC-100-KIT
SG-4200TIP	GC-2255

SPRAY GUN ^{SPOT} ADJUSTABLE



Part#

SG-4507F
SG-4507F-CB

FEATURES

Ideal for up to 100 PSI & 2.2 GPM #18 orifice
Trigger lock for continuous use Filter in handle
30" overall length 3/8" hose barb inlet

Compatible Replacement Parts

GC-100	GC-100-KIT
SG-45ASSY-18	GC-2255

SPRAY GUN ^{TELESCOPING SPOT} ADJUSTABLE



Part#

SG-500T
SG-500T-CB

FEATURES

Ideal for up to 100 PSI & 2.2 GPM #18 orifice
Trigger lock for continuous use Filter in handle
40" overall length 3/8" hose barb inlet

Compatible Replacement Parts

GC-100	GC-100-KIT
SG-45ASSY-18	GC-2255

SPRAY GUN ^{PISTOL SPOT} ADJUSTABLE



Part#

Spray Gun Length

SG-5518-09	9"
SG-5518-09-CB	9"
SG-5518-18	18"
SG-5518-18-CB	18"
SG-5518-24	24"

FEATURES

Ideal for up to 350 PSI and 7.0GPM #18 orifice size
3/8" brass hose barb inlet Heavy-duty brass nozzle
Trigger lock to prevent unwanted spray

-CB suffix denotes retail-ready, feature wrap packaging.

SPRAY

DELUXE ADJUSTABLE SPRAY GUNS PISTOL GRIP



Part#	Length	Color
SG-2218-18	18"	Blue
SG-2218-18-CB	18"	Blue
SG-2218-18-R	18"	Red
SG-2218-24	24"	Red
SG-2218-24-CB	24"	Red

FEATURES

Ideal for up to 250 PSI and 7.0GPM #18 orifice size
 Trigger lock for continuous use Heavy-duty brass nozzle
 3/8" hose barb inlet

DELUXE ADJUSTABLE SPRAY GUN WANDLESS PISTOL GRIP



Part#

SG-5524-00

FEATURES

Ideal for up to 350 PSI #24 orifice size
 3/8" FNPT inlet Nozzle twists from stream to mist
 Heavy-duty brass nozzle Trigger lock prevents unwanted spray

FLASH SPRAY GUN ADJUSTABLE



Part#	Length
SG-2200	16"
SG-2200-CSK*	16"

FEATURES

Ideal for up to 400 PSI and 5.0 GPM.
 Adjustable lever that provides steady stream or atomized mist.
 No-drip shut-off at end of barrel.
 Trigger lock for continuous use.
 3/8" brass hose barb inlet.
 *Includes interchangeable #2 and #2.5 orifice nozzles and 1/2" hose barb.

SPRAY GUN SWIVEL BRASS



Part#	Description
SW-12BS	1/2" MBSPT x 1/2" FBSPT

RETAIL PACKAGING FOR SPRAY GUNS INCLUDES:



- Plastic Peghook Hole for Hanging
- Full Color, Two-Sided Feature Wrap



LONG RANGE SPRAY GUN ADJUSTABLE



Part#	Length
SG-3200	26.5"

FEATURES

Ideal for up to 800 PSI and 25.0 GPM.
 Adjustable handle that provides steady stream or atomized mist.
 No-drip shut-off at end of barrel.
 Trigger lock for continuous use.
 1/2" brass hose barb inlet.

-CSK suffix denotes retail-ready clamshell packaging.

-CB suffix denotes retail-ready, feature wrap packaging.

GUNS

JETSTREAM

Made with aluminum barrels, Jetstream Spray Guns are designed for more intensive sprayer applications that require higher volumes of liquid.

JETSTREAM PISTOL SPRAY GUN 13" OR 22" BARREL



Part#	Barrel Length
SG-1700-13	13"
SG-1700-22	22"

FEATURES

Ideal for up to 800 PSI.
Goes from stream to mist during trigger pull.
No-drip shut-off at end of barrel.
Chemical-resistant plastic handle for increased durability.
1/2" FNPT inlet.

JETSTREAM TWIST SPRAY GUN 23" BARREL



Part#	Barrel Length
SG-1005	23"

FEATURES

Ideal for up to 400 PSI.
Goes from stream to mist with a twist of the handle.
No-drip shut-off at end of barrel.
Chemical-resistant plastic handle for increased durability.
3/4" FGHT inlet.

PEST CONTROL SPRAY GUN ADJUSTABLE JET



Part#
SG-PC-025

FEATURES

Durable Teflon Seals
2.5MM Spray Nozzle
Adjustable Mist-Jet
Brass 1/2" FNPT Inlet
Locking spray grip
800 PSI Max

REPLACEMENT NOZZLES



Part#	Size	Dia.	GPM
SG-PCN-008	Small	0.8	0.3-0.5
SG-PCN-015	Med	1.5	0.5-2.0
SG-PCN-025	Large	2.5	2.0-5.0
SG-PCN-030	XL	3.0	3.0-7.0
SG-PCN-040	2XL	4.0	6.0-11.0
SG-PCN-045	3XL	4.5	8.0-13.5

BRASS SPRAY TIP ADJUSTABLE



Part#	Orifice Size
900.054-8	#8
900.054-8-CSK	#8
900.054-18	#18
900.054-18-CSK	#18
900.054-24	#24

HOSE REELS

75-200 FOOT HOSE REELS MANUAL



Part#	Hose Capacity
HR-75	75'
HR-100	100'
HR-200	200'

FEATURES

3/8" ID Spray Hose	Powder coated steel frame
Swivel included	3000 PSI Max.

HOSE REEL SWIVELS



Part#	Connection Size	PSI
HRS-6M6F	1/2" MNPT x 1/2" FNPT	725
HRS-8M8F	1/2" FNPT x 1/2" FNPT	725
33-103831	3/8" MNPT x 3/8" FNPT	4000
33-201018	1/2" MNPT x 1/2" FNPT	4000
33-201035	1/2" MNPT x 1/2" FNPT	5000
33-201078	1/2" FNPT x 1/2" FNPT	5000

12" & 18" ALUMINUM HOSE REELS HEAVY-DUTY MANUAL

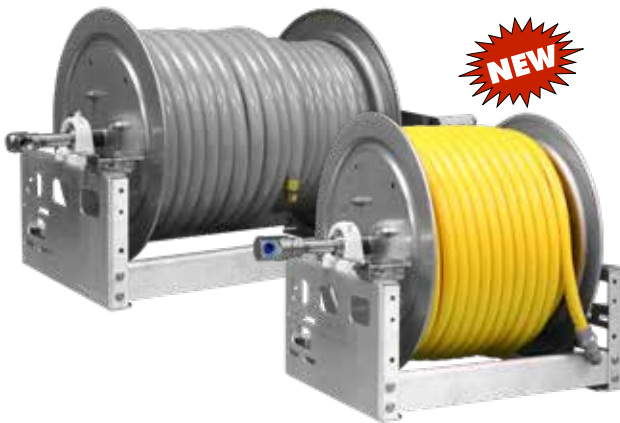

Part#	Size	Type	PSI
HR-12AF-SW	12"	Soft Wash	750
HR-18AF-SW	18"	Soft Wash	750
HR-12AF-HP	12"	High Pressure	5000
HR-18AF-HP	18"	High Pressure	5000

FEATURES

3/4" ID Spray Hose	Aircraft aluminum frame
HARDCORE Technology	Bolt-on construction
1/2" NPT threads	Lightweight & durable

12" & 18" ALUMINUM HOSE REELS HEAVY-DUTY ELECTRIC



Part#	Size	Type	PSI
HR-12AF-E-SW	12"	Soft Wash	750
HR-18AF-E-SW	18"	Soft Wash	750
HR-12AF-E-HP	12"	High Pressure	5000
HR-18AF-E-HP	18"	High Pressure	5000

FEATURES

3/4" ID Spray Hose	Aircraft aluminum frame
HARDCORE Technology	Heavy-duty electric motor
1/2" NPT threads	Includes chain guard

SPRAYERS

HANDHELD



SPRAYER FEATURES

- Lightweight and Easy to Use
- Single Conical Spray Tip
- Pressure Relief Valve
- Handle-Action Piston Pump
- Large Mouth for Easy Filling
- Ergonomic Handle

1.2 & 2.0 LITER SPRAYERS HANDHELD



Part#	Capacity
90700012	1.2 Liter (.32 Gallon)
90700002	2.0 Liter (.51 Gallon)

ALUMINUM STACKING KITS HEAVY-DUTY

NEW

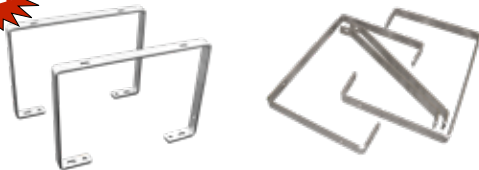

Part#	Compatible Valley Hose Reels
HR-AFST-KIT	Manual
HR-AFEST-KIT	Electric

ALUMINUM HOSE GUIDES HEAVY-DUTY

NEW



Part#	Size	Compatible Valley Hose Reels
HG-12-AL	12"	Manual & Electric
HG-18-AL	18"	Manual & Electric

6.5 & 8.0 LITER SPRAYERS HANDHELD



Part#	Capacity
90700065	6.5 Liter (1.72 Gallons)
90700008	8.0 Liter (2.11 Gallons)

BACKPACK

4 GALLON BACKPACK SPRAYER HAND PUMPED



FEATURES

- Fan, Conical, 4-Hole Adjustable & Dual Conical Spray Tips Included
- Ergonomically Designed Tank.
- Wide-Mouthed Tank Lid Opening for Less Spillage
- Easily Convert from Left to Right Hand Operation
- Lever Action Piston Pump Offers 15-90 PSI
- Built-In Carry Handle Lid for Easy Transport
- Lance Clips to the Tank for Convenient Storage
- Built-In Strainer & Screen to Prevent Clogging
- Quick Fitting Shoulder Harness
- Quality Viton Seals
- Complete Spare Parts Kit

BPS-405



INCLUDED SPRAY TIPS

FLAT FAN



CONICAL



4-HOLE ADJUSTABLE



DUAL CONICAL



INCLUDED REPAIR KIT BPS-405-9



Part#	Description
BPS-405-9	Complete seal and parts kit included with sprayer.

SPRAYERS



FEATURES

- No Pumping & No Wires Required
- 14.4 Volt Lithium-Ion Rechargeable Battery
- Internal Battery Compartment
- 1.0 GPM Everflo Diaphragm Pump Offers 40 PSI
- Adjustable Spray Gun Goes from Mist to Stream
- 5' Braided Nylon Hose to Spray Gun
- Ergonomically Designed Tank
- 6" Screw-On Fill Lid for Less Spillage
- Built-In Carry Handle Lid for Easy Transport
- Lance Clips to Lid for Convenient Storage
- Fill-Lid Screen to Prevent Clogging
- Adjustable, Padded Shoulder Straps
- Battery Charger Included
- Up To 30 Gallons on a Single Charge
- Comes in Full Color Retail Box



BPS-REV401

REVOLT 14.4 VOLT CONVERSION (SOLD SEPARATELY)



Part#	Description
REVOLT-144-1	Lithium-Ion Rechargeable Sprayer Conversion Kit

FEATURES

- Convert a 1.0 GPM sprayer to lithium-ion power.
- All-steel, powder coated battery dock with lighted power indicator switch.
- Rechargeable Revolt 14.4v lithium-ion battery.
- Includes charging cable in retail windowed box.

4 GALLON BACKPACK SPRAYER LI-ION BATTERY



REPLACEMENT BATTERY (SOLD SEPARATELY)

Part#	Description
REVOLT-144-B-CSK	14.4 Volt Battery for Revolt Sprayers & Kits

HITCH

GRADE 2 HARDNESS HITCH PINS

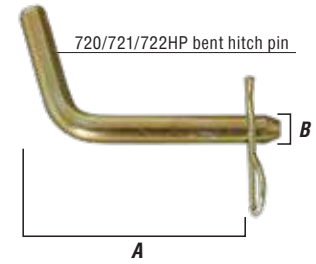
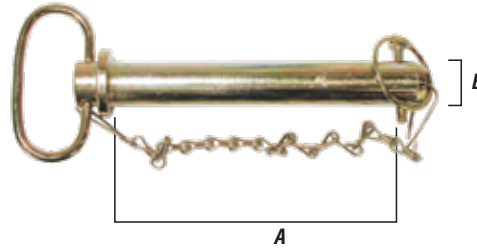

720/721/722HP bent hitch pin

Part#	Case#	JD#	Farmex#	HH#	Speco#	Tisco#	A Length	B Pin Dia.
700HP	B500176	TY4012	14891	29836	P71032CL	PS7506	6¼"	¾"
701HP	B500177	TY4013	17881	29843	P71042CL	PS8756	6¼"	7/8"
702HP	N/A	TY4009	15201	29821	P71021CL	PS6254	4¼"	5/8"
703HP	B500175	TY4010	15211	29832	P71031CL	PS7504	4¼"	¾"
704HP	B500174	TY15737	14881	29826	P71022CL	PS6256	6¼"	5/8"
705HP	B500172	TY15736	22131	29810	P71011CL	PS5004	3½"	½"
706HP	B500178	N/A	17891	29854	P71052CL	PS1006	6¼"	1"
707HP	B500179	N/A	17901	29865	P71062CL	PS1126	6¼"	1½"
708HP	B500180	N/A	18001	29876	P71072CL	PS1256	6¼"	1¼"
709HP	N/A	N/A	N/A	N/A	N/A	N/A	4¼"	7/8"
713HP*	N/A	N/A	01789	25653	P71052C	P51006	6¼"	1"
715HP	N/A	N/A	N/A	29808	P71010C	N/A	4¼"	3/8"
720HP	N/A	N/A	01410	10312	P71111	N/A	3"	½"
721HP	N/A	N/A	N/A	N/A	N/A	N/A	3½"	¾"
722HP	N/A	N/A	33108	N/A	P7922	N/A	3"	5/8"

All of the above hitch pins are Grade 2 hardness. *713HP does not include pin.

RUBBER HANDLED HITCH PINS GRADE 5 & 8 HARDNESS

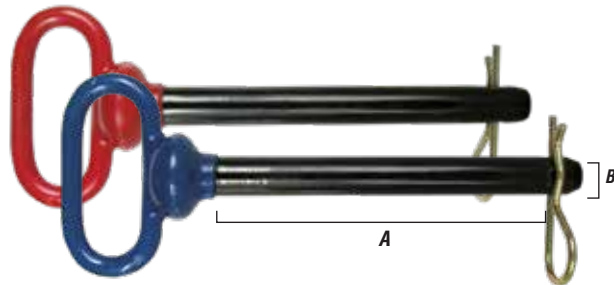

Part# Red	Part# Blue	Case#	Farmex#	Speco#	HH#	A Length	B Pin Dia.
705HPR	705HPBLU	B504050	1500	P700511	00113	35/8"	½"
702HPR	702HPBLU	B504051	1501	P700521	00223	4"	5/8"
703HPR	703HPBLU	B504053	1503	P700531	00233	4"	¾"
700HPR	700HPBLU	B504054	1504	P700532	00133	6½"	¾"
701HPR	701HPBLU	B504055	1506	P700542	00143	6½"	7/8"
706HPR	706HPBLU	B504056	1508	P700552	00153	7"	1"
707HPR	N/A	8504057	1510	P700562	00163	8½"	1½"
N/A	707HPBLU	N/A	N/A	N/A	N/A	7"	1½"
708HPR	708HPBLU	N/A	1512	P700572	00173	8½"	1¼"
710HPR	N/A	N/A	N/A	P700522	N/A	5½"	5/8"
715HPR	N/A	N/A	N/A	P700582	N/A	8½"	1½"

All include rubber coated handle. Red handled are Grade 5 hardness. Blue handled pins are Grade 8 hardness.

PINS

FORGED HITCH PINS

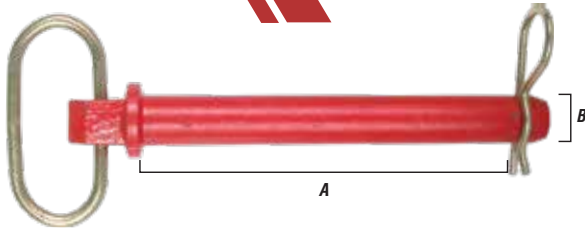

Part#	A (Length)	B (Pin Dia.)	Part#	A (Length)	B (Pin Dia.)
700FHP	6 1/4"	3/4"	705FHP	3 1/2"	1/2"
701FHP	6 1/2"	7/8"	706FHP	6 3/4"	1"
702FHP	3 5/8"	5/8"	707FHP	7"	1 1/8"
703FHP	4"	3/4"	708FHP	7"	1 1/4"

SPRING SNAP-LOCK HITCH PINS

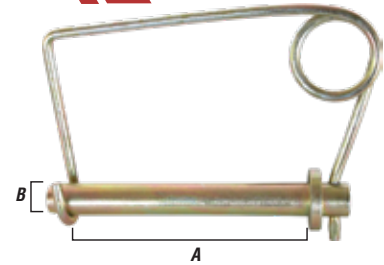

Part#	A	B
710HP	4 1/2"	1/2"
711HP	4 1/2"	5/8"
712HP	4 1/4"	3/4"

CLEVIS PINS

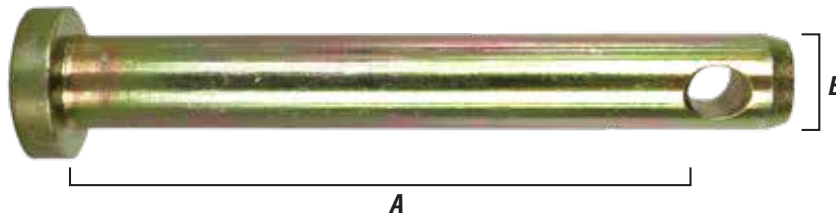

Part#	OEM#	HH#	A Length	B Pin Diameter
6043	17102	63797	5 1/2"	3/4"
6044	17103	63836	5 1/2"	7/8"
6045	17104	63861	5 3/4"	1"
6046	17105	63882	5 3/4"	1 1/8"

TOP LINKS

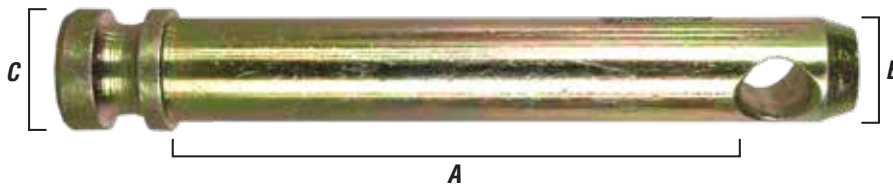

Part#	Case#	Farmex#	HH#	Speeco#	Tisco#	Model	A Length	B Pin Dia	C Head Size
104P	B500183	03173	21250	P776	P70706	Cat 0	2 3/4"	5/8"	3/4"
105P	B500184	00073	21252	P771	P1010	Cat 1	2 3/4"	3/4"	7/8"
106P	B500187	00076	21260	P7719	P12325	Cat 2	3 3/8"	1"	1 1/8"
107P	B500186	00074	21256	P773	P1500	Cat 3	3 7/8"	3/4"	7/8"
108P	B500188	03011	21262	P774	P2450	Cat 2	4 5/16"	1"	1 1/8"
109P	B500189	03026	21270	P7711	P7711	Cat 3	4 7/16"	1 1/4"	1 3/8"
110P	N/A	00074	21257	P7715	N/A	Cat 1	4 3/4"	3/4"	

IMPLEMENT &

DOUBLE CHAIN CLEVIS



Part #	Chain Size
64.000.003	3/8"
64.000.004	1/4" to 5/16"
64.000.005	7/16" to 1/2"

UTILITY CLEVIS



Part #	Body Size	Pin Dia	Usable Length
64.400.038	3/8"	7/16"	1 1/4"
64.400.716	7/16"	1/2"	1 1/2"

TWISTED CLEVIS



Part #	Body Size	Pin Dia	Usable Length
64.200.058	5/8"	1/2"	2 1/4"
64.200.075	3/4"	5/8"	3"
64.200.078	7/8"	3/4"	3 1/4"
64.201.516	15/16"	7/8"	3 3/4"
64.200.001	1"	1"	4 1/4"

STRAIGHT CLEVIS



Part #	Body Size	Pin Dia	Usable Length
64.300.058	5/8"	1/2"	2 1/4"
64.300.075	3/4"	5/8"	3"
64.300.078	7/8"	3/4"	3 1/4"
64.301.516	15/16"	7/8"	3 3/4"
64.300.001	1"	1"	4 1/4"

DRAW BAR HOOK



Part #	Working Load Limit
64.038.002	9,500 lbs

IMPLEMENT PINS

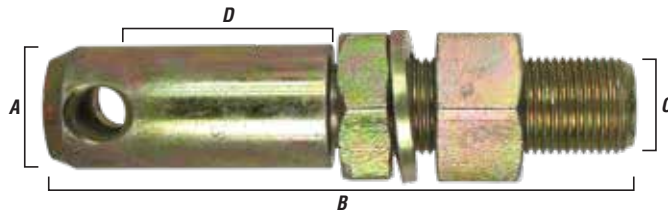

Part#	Case#	Farmex#	HH#	Speeco#	Tisco#	Size	A Pin Dia.	B Overall Length	C UNF Thread	D Usable Length
149IP	B500195	03137	21210	P7220	N/A	Cat 0 Adjustable	5/8"	37/8"	5/8"	13/16"
150IP	B504050	3133	21212	P7221	N/A	Cat 1-0 Adjustable	7/8"	45/8"	5/8"	113/16"
151IP	B500196	00211	21222	P722	P2009	Cat 1 Adjustable	7/8"	55/16"	7/8"	17/8"
154IP	B500199	3001	21230	P724	P2009XL	Cat 2 Adjustable	11/8"	53/16"	7/8"	113/16"
159IP	N/A	3000	21233	P7219	N/A	Cat 1 Extra Long Adjustable	7/8"	61/4"	7/8"	2"
161IP	N/A	3002	N/A	P721	N/A	Cat 1 Adjustable	7/8"	63/8"	11/8"	13/4"
160IP	N/A	3002	21241	P7249	P2059	Cat 2 Adjustable	11/8"	53/8"	11/8"	21/8"

CLEVIS PINS

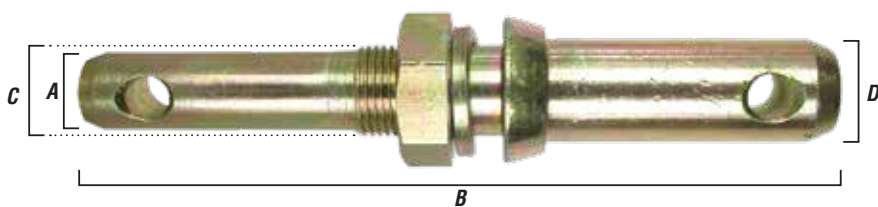

Part#	Speeco#	Size	HH#	A Pin Dia	B OAL	C UNF Thread	D Pin Dia
162IP	P726	Cat 1 & 2	21235	7/8"	7 1/2"	1"	1 1/8"

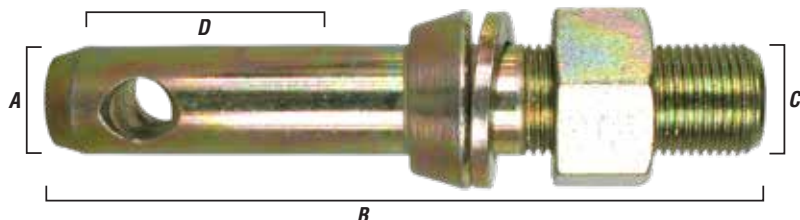

Part#	Case#	Farmex#	HH#	Speeco#	Tisco#	Size	A Pin Dia.	B OAL	C UNF Thread	D Usable Length
152IP	B500197	00200	21226	P728	P2000	Cat 1 Forged	7/8"	5 1/2"	7/8"	1 3/4"
153IP	B500199	3004	21224	P7245	P2000XL	Cat 1 Extra Long Forged	7/8"	6 1/2"	7/8"	2 1/4"
155IP	N/A	00202	21232	P7240	N/A	Cat 2 Forged	1 1/8"	5 1/4"	7/8"	1 5/8"
156IP	B500201	3178	21240	P7246	P6502	Cat 2 Extra Long Forged	1 1/8"	6 5/16"	7/8"	2 1/4"
157IP	B500202	3006	21242	P7212	N/A	Cat 2 Forged	1 1/8"	6 1/4"	1 1/8"	1 3/4"

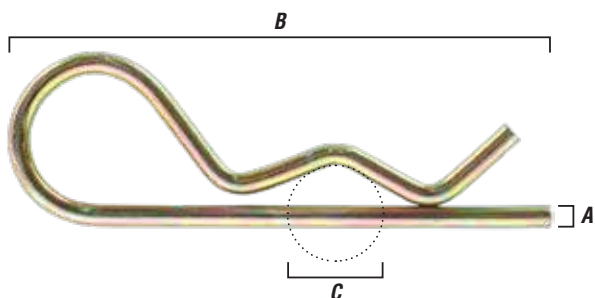

Part#	Case#	Farmex#	HH#	A Wire Dia	B OAL	C Diameter
P-7922	N/A	33108	68821	2 (1/16")	42 (1 3/4")	6-11 (5/16" - 7/16")
P-7923	00009	33109	68838	2.5 (3/32")	43 (1 3/4")	8-12 (7/16" - 9/16")
P-7924	B504905	33110	68860	3 (1/8")	64 (2 1/2")	10-18 (9/16" - 3/4")
P-7925	B504906	33112	68870	4 (5/32")	76 (3")	12-22 (3/4" - 7/8")
P-7927	B504907	33113	68880	5 (3/16")	105 (4")	10-18 (7/8" - 1")
P-7928	N/A	33114	68884	6 (7/32")	123 (4 3/4")	16-27 (7/8" - 1 1/8")



LYNCH & LOCK PINS

SQUARE LOCK PINS FOR PTO ADAPTERS

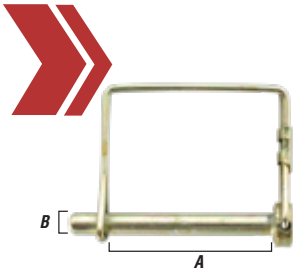

ROUND LOCK PINS FOR PTO ADAPTERS

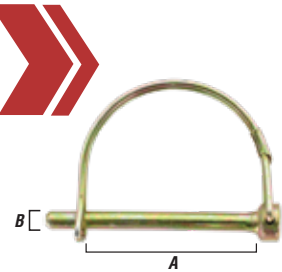

Part#	Farmex#	Speeco#	HH#	A Length	B Pin Dia.
904PA	32276	P7939	21980	2¼"	⅝"
905PA	32275	P7964	21984	2¼"	⅜"

Part#	Farmex#	Speeco#	HH#	A Length	B Pin Dia.
908PA	32263	P7938	21970	1¾"	¼"
903PA	00264/32263	P7951	21973	2¼"	¼"
906PA	32265	P7941	21986	2¼"	⅜"
900PA	00266	P7940	21982	2¼"	⅝"

LYNCH PINS



	Part#	Case#	Farmex#	Speeco#	HH#	Type	Pin Dia.
	804LP	<i>Replaces 03548</i>	32204	N/A	21910	Standard Pin	⅜"
	800LP	B500169	32207	P794	21920	Standard Pin	¼"
	802LP	B504901	32205	P7915	21930	Standard Pin	⅝"
1	801LP	B500170	2703	P791	21940	Standard Pin	7/16"
	803LP	B500171	33027	P7913	21960	Black Ring H.D.	7/16"
	805LP	N/A	N/A	P7916		Standard Pin	⅜"
2	806LP	N/A	N/A	P792	21945	Standard Pin with Chain	7/16"

TOP LINKS

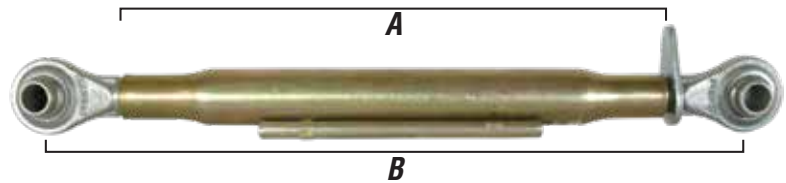

Part#	Case#	Farmex#	Speeco#	HH#	Size	A Tube Length	B (min) Adj Length	C (max) Adj Length
204TL	B500219	03470	TL199	22506	Cat 0	7½"	10½"	16"
205TL	B500219	00480	TL199	22508	Cat 1 Short Tube	13"	17½"	24"
206TL	B500220	00332	TL165	22510	Cat 1	16"	20½"	31"
206TL-1*	B500220	00331	TL165		Cat 1	16"	20½"	31"
207TL	N/A	00335	TL166	22512	Cat 1	20"	24½"	35"
208TL	N/A	00338	TL1670	22515	Cat 1, 2	16"	21¾"	31"
209TL	B500222	00340	TL174	22520	Cat 2	16"	21"	31½"
209TLHD	N/A	03473	N/A	22525	Cat 2 Heavy Duty	15"	20½"	31½"
210TL	N/A	00337	TL176	22522	Cat 2	20"	25"	36½"

* Comes with hex adjuster

BUSHINGS

& PTO ADAPTERS



HITCH BUSHING

Part#
473RB Replaces 03015
Cat 2, 3 reducer. Mounts on Hitch Pin

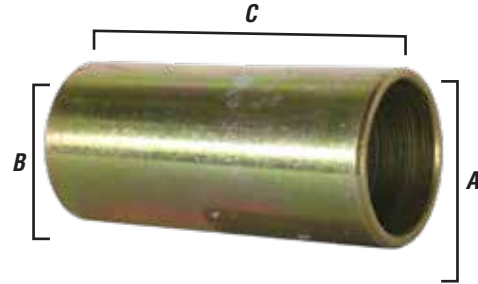

REDUCER BUSHINGS

Part#	Link	Farmex#	HH#	Speeco#	Tisco#	Size	A Out Dia.	B In Dia.	C Length
474RB	Top	N/A	2118	B-829	N/A	Cat 1-0	3/4"	5/8"	15/8"
478RB	Top	32250	21190	B-831	P2007	Cat 2-1	1"	3/4"	15/16"
476RB	Top	33008	21192	B-833	N/A	Cat 3-2	1 1/4"	1"	1 3/4"
475RB	Bottom	N/A	21189	B-828	N/A	Cat 1-0	7/8"	5/8"	1 3/8"
477RB	Bottom	32252	21194	B-821	P2007	Cat 2-1	1 1/8"	7/8"	1 3/4"
479RB	Bottom	33009	21195	B-832	N/A	Cat 3-2	1 7/16"	1 1/8"	1 3/4"

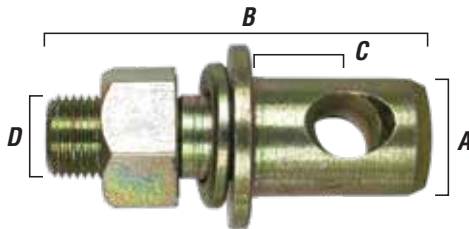

STABILIZER STUB PINS

Part#	Farmex#	Speeco#	Ford#	HH#	A Hole Size	B OAL	C Usable Length	D UNF Thread
780P	N/A	P711	N/A	21284	7/8"	3 1/4"	1/2"	7/8"
781P	32260	P781	230044	21281	7/8"	2 5/8"	3/8"	5/8"
785P	03107	P785	141185	21283	7/8"	3 1/8"	1 1/4"	5/8"

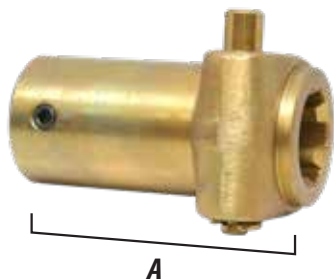

PTO ADAPTERS

Part#	A	(F)emale	Key	Replacement Pin
602PA	4 11/32"	1 3/8" 6 Spline x 5/8"	3/16"	610PA
603PA	4 11/32"	1 3/8" 6 Spline x 3/4"	3/16"	610PA
605PA	4 11/32"	1 3/8" 6 Spline x 15/16"	1/4"	610PA

STABILIZERS & DRAW BARS

LOWER LINK & STABILIZER ARMS

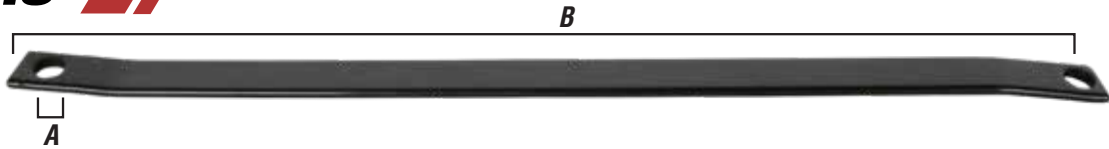

Part#	Farmex#	HH#	Speeco#	A (Hole Diameter)	B (Length from center)
301S	00176	24176	SA621	7/8"	31 9/16"
302S	00177	24177	SA622	7/8"	33 3/8"

ADJUSTABLE STABILIZER

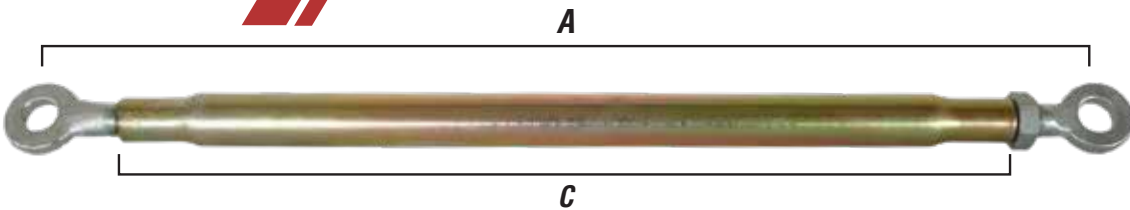

Part#	Case#	HH#	Speeco#	Tisco#	A min (Adjustable)	B max (Adjustable)	C Tube Length
300S	B504062	24159	SA-6260	JSA1003	27 1/2"	35"	21 7/8"
Replacement Parts			72-04-A (LH)		72-04-B (RH)		

DRAW BARS

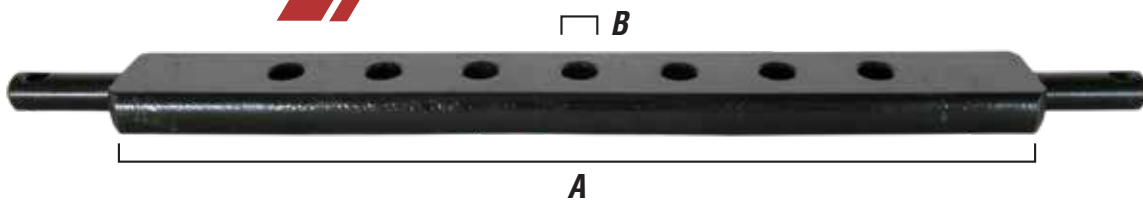

Part#	Case#	Farmex#	Speeco#	HH#	Size	A Usable Length	B Hole Dia.	C # of Holes
1005DB	N/A	10419	DB-418	22718	Cat 0	20"	5/8"	7
1000DB	B500235	10419	DB-419	22719	Cat 1	20"	3/4"	7
1002DB	B500236	10411	DB-411	22711	Cat 1	26"	3/4"	11
1001DB	B500238	10432	DB-422	22732	Cat 2	32"	3/4"	13
1003DB	B500237	10421	DB-421	22721	Cat 2 Heavy Duty	26"	3/4"	11

ACCESSORIES

& SECURING PINS

STEERING WHEEL SPINNERS



Part#	HH#	Description
67.094.060	26951	Ball bearing style spinner, comes with mounting bracket.
67.095.060	N/A	Wooden Steering Wheel Spinner

Wheel Spinners are prepackaged in blister pack.

UNIVERSAL STROKE CONTROL SEGMENTS

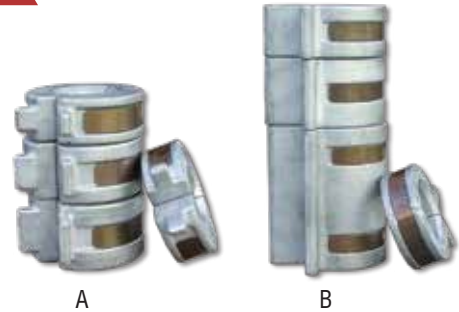

Part #	Segment Sizes	Cylinder Shaft Sizes	Type
46.999.002	7/8", 1", 1-1/4", 1-1/2"	1-1/8", 1-1/4"	A
46.999.003	7/8", 1", 1-1/4", 1-1/2"	1-3/8", 1-1/2"	A
46.999.004	1", 1-1/4", 1-1/2", 4-1/4"	1-3/4", 1-7/8", 2"	B

LIFT ARM LEVELING ASSEMBLY



Part#	HH#	OEM #s	Pin Size	Min. Length	Max. Length
350JA	22590	Case# B504067, Farmex # 1542, Speeco # TL175	1"	20"	28"

SECURING PIN

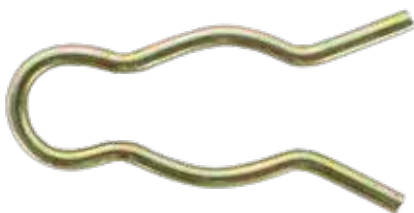

Part#	P-7910
Farmex#	00017
Tisco#	P7910
HH#	30888

Additional Information
Fits P-7712, P-7713 and 1" hydraulic

SECURING PINS

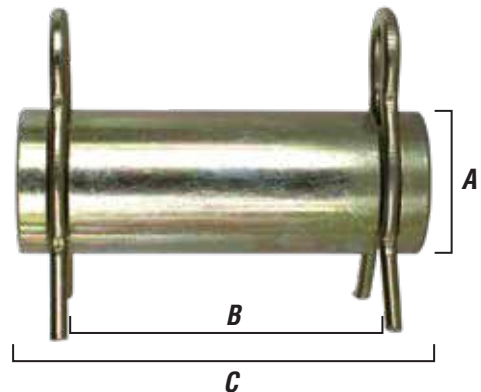

	P-7712	P-7713
Case#	B504952	N/A
Farmex#	1544	N/A
HH#	10200	10210
Fits	BE350JA	Most 3/8 hyd.
Clevis Pin Dia.	A 1"	1"
Usable Length	B 2"	3 7/8"
Overall Length	C 2 3/4"	3 15/16"

TRAILER



**OTHER
ZINC JACKS
AVAILABLE**

A-FRAME & WELD COLLAR TRAILER JACKS

Part#	Jack Type	Wind Style	Max Weight	Lift	A (Height)
VI-120	A-Frame 3 Hole Flange	Top	2000 Lbs	13 1/2"	7"
VI-130	A-Frame 3 Hole Flange	Side	2000 Lbs	13 1/2"	7"
VI-140	A-Frame, 3 Hole Flange	Top	5000 Lbs	13 1/2"	7"
VI-020	10" Weld Collar	Top	2000 Lbs	10"	11 1/4"
VI-050	10" Weld Collar	Side	5000 Lbs	10"	11"
VI-520	5" Weld Collar	Top	2000 Lbs	15"	15 1/2"
VI-550	15" Weld Collar	Side	5000 Lbs	15"	15 1/2"
VI-555	Zinc Plated Weld Collar	Top	5000 Lbs	15"	15 1/2"
LT-5103	Zinc Plated Weld Collar	Side	8000 Lbs	10"	
LT-5153	Zinc Plated Weld Collar	Side	8000 Lbs	15"	
ST-2104	Zinc Plated Weld Collar	Top	2000 Lbs	10"	
ST-2154	Zinc Plated Weld Collar	Top	2000 Lbs	15"	

JACKS



FLANGE, WHEEL & HEAVY DUTY TRAILER JACKS

Part#	Jack Type	Wind Style	Max Weight	Lift
FJ-020	Flange	Top	2000 Lbs	10"
FJ-530	Flange	Top	2000 Lbs	15"
TJ-06-01K	Single Wheel	Side	1200 Lbs	10"
TJ-06-02K	6" Dual Wheel	Side	1500 Lbs	10"
TJ-06-06K	8" HD Wheel	Side	1500 Lbs	10"
TJ-07-51L	Bolt On, Wheeled, Side Wind, Zinc Plated	Side	1200 Lbs	15"
HEAVY DUTY JACKS		Wind Style	Max Weight	Lift
VI-720	HD Square Tubing, with Telescoping Leg	Top	8000 Lbs	26"
VI-700	HD Square Tubing, with Telescoping Leg	Side	8000 Lbs	26"
VI-800-EL	12V Electric, 18" Lift (24" Lift w/Drop Foot) Boxed	Electric	3500 Lbs	18/24"
VI-1200	HD Square Tubing, Telescoping Leg, Includes Handle	Side	12,000 Lbs	26"
VI-1220	HD Square Tubing, Telescoping Leg, Includes Handle	Top	12,000 Lbs	26"

TRAILER JACK

COLLAR MOUNT PINS



Part#	Diameter
VI-025-CS	9/16"
VI-027-CS	5/8"

REPLACEMENT WHEEL 6" DIAMETER



Part#	Max Weight	Compatible Valley Jacks
TJ-06-04	1000 lbs	TJ-06-01K
TJ-06-04-CS	1000 lbs	TJ-06-01K

A-FRAME WHEEL 6" DIAMETER



Part#	Max Weight	Compatible Valley Jacks
TJ-06-05	1000 lbs	All A-Frame Jacks
TJ-06-05-CS	1000 lbs	All A-Frame Jacks

WELD-ON BRACKET



Part#	Compatible Valley Jacks
VI-701	VI-700 and VI-720
VI-701-CS	VI-700 and VI-720

A-FRAME WHEEL 6" DIAMETER



Part#	Max Weight	Compatible Valley Jacks
TJ-06-02	1000 lbs	All A-Frame Jacks
TJ-06-02-CS	1000 lbs	All A-Frame Jacks

REPLACEMENT HANDLE TOP WIND



Part#	Compatible Valley Jacks
XA.003.999	All Top Wind Jacks
XA.003.999-CS	All Top Wind Jacks

-CS suffix denotes retail-ready clamshell packaging.

ACCESSORIES

REPLACEMENT HANDLE TOP WIND



Part#	Compatible Valley Jacks
VI-704	VI-720

REPLACEMENT HANDLE SIDE WIND



Part#	Compatible Valley Jacks
VI-703	VI-700

RETAINING RING



Part#	Compatible Valley Jacks
TJ-06-07-CS	All Flange jacks

A-FRAME BASE



Part#	Compatible Valley Jacks
TJ-06-03	VI-120
TJ-06-03-CS	VI-120

INNER MOUNTING TUBES



Part#	Hole Diameter
64.002.000	9/16"
64.002.000-CS	9/16"

OUTER MOUNTING TUBES



Part#	Hole Diameter
64.003.000	9/16"
64.003.000-CS	9/16"
64.003.058	5/8"
64.003.058-CS	5/8"

FLANGE MOUNTING KIT



Part#	Kit Includes
FJ-02-20B	Flange, Pin, Spring & Clips
FJ-02-20B-CS	Flange, Pin, Spring & Clips

-CS suffix denotes retail-ready clamshell packaging.

WINCHES

TRAILER
WINCHES
600-2500 LBS



FEATURES

Side Wind
Spring Loaded Hub Lock
Ideal for loading vehicles
and equipment

Bolt Mounted
Metal Tow Hook
Steel construction



TW-600-C08



TW-1000-C10



TW-1400-C10,
TW-1600-C10



TW-1600-S20



TW-2500-C10

REPLACEMENT PARTS

Part#	Description
TW-CAB10	10' Cable
TW-STP20	20' Strap



RETAIL READY IN FULL COLOR BOXES

Part#	Max Load	Handle	Ratio	Length
TW-600-C08	600 Lbs	6.5"	3.1:1	8' Cable
TW-1000-C10	1000 Lbs	7.8"	4.1:1	10' Cable
TW-1400-C10	1400 Lbs	8.8"	4.1:1	10' Cable
TW-1600-C10	1600 Lbs	8.8"	5.1:1	10' Cable
TW-1600-S20	1600 Lbs	8.8"	5.1:1	20' Strap
TW-2500-C10	2500 Lbs	10.8"	5.1:1 & 12.1:1	10' Cable

ACCESSORIES

PUMPS, FITTINGS & UTILITY JUGS

3.0 GPM DIAPHRAGM RV PUMP FRESH WATER



Part#	Port Size	Packaging
EFRV3000-BOX	1/2" NPSM	Boxed
FEATURES		
55 PSI	Polypropylene Housing & Valve Plate	
9.5 Max Amps	Zinc Plated Steel Fasteners	
Self Priming to 10'	Painted Steel 5" Motor Shell	
CE Approved	Two 1/2" NPS HB Fittings & 1/2" NPS Inline Strainer	
Auto Shut-Off	Certified Safe for Drinking Water	
Inline Fuse Protection	DXS-3 Valves & Santoprene Diaphragm 130° F Max Temperature Rating	



INLINE STRAINER MPTxFPT

Part#	Description
EFRV-IS12	Inline Strainer, 1/2" Ports, 50 Mesh
EFRV-IS12-CSK	As above, clamshelled



HOSE BARB SWIVELS

Part#	Size	Type
EFRV-SWA12	1/2"	Straight
EFRV-SWEL12	1/2"	Elbow

5.0 GPM DIAPHRAGM RV PUMP FRESH WATER



Part#	Port Size	Packaging
EFRV5000-BOX	1/2" NPSM	Boxed
FEATURES		
55 PSI	Polypropylene Housing & Valve Plate	
16.0 Max Amps	Zinc Plated Steel Fasteners	
Self Priming to 10'	Painted Steel 5" Motor Shell	
CE Approved	Two 1/2" NPS HB Fittings & 1/2" NPS Inline Strainer	
Auto Shut-Off	Certified Safe for Drinking Water	
Inline Fuse Protection	DXS-3 Valves & Santoprene Diaphragm 130° F Max Temperature Rating	



UTILITY JUGS 5 GALLON



Part#	Color	FEATURES
UJ-05-WHT	White	Vented for easy pouring
UJ-05-RED	Red	Chemical resistant HDPE
UJ-05-YLW	Yellow	Cap and o-ring seal
UJ-05-BLU	Blue	Convenient grip points
		Raised fill markings (1G/5L)
		Customized branding available

DISCLAIMER: Not a portable fuel container as described by ASTM, EPA, ARB and other official agencies.

REPLACEMENT PUMPS

PRODUCT PACKAGING LEGEND

The background color of each part number tells you how it is packaged, as shown here:

Clamshelled
Barcoded or Boxed
Bulk Packed
Flag Tagged

16 INCH WATER BROOM UNDER CAR



Part#	PK-85400062
Max Pressure	4,000 PSI
Max Flow	3 GPM
Connection	1/4" Quick-Disconnect plug
Nozzles	4

FEATURES

360° Rubber swivel wheels for easy movement.
Made of aluminum alloy and steel for increased durability.
Perfect for cleaning vehicle undercarriages.

12 INCH WATER BROOM THREE NOZZLE



Part#	PK-85400060
Max Pressure	4,000 PSI
Max Flow	3 GPM
Connection	1/4" Quick-Disconnect plug
Nozzles	3

FEATURES

360° rubber swivel wheels for easy movement.
Made of aluminum alloy and steel for increased durability.
Perfect for cleaning a wide range of flat surfaces.

PRESSURE WASHER PUMP AXIAL



Part#	PK-AXPUMP		
PSI	3,100	Shaft	3/4"
RPM	3,400	HP	4-7
GPM	2.3	Motor	Gas

FEATURES

Bolts-on a 3/4" gas engine shaft.
Pre-installed adjustable unloader and thermal relief valve.
Includes 3-feet of soap tubing with filter.
Made of anodized die-cast aluminum to prevent corrosion.
Includes adapters for universal connections to accessories.

PRESSURE WASHER PUMP TRIPLEX



Part#	PK-PSNPUMP		
PSI	3,700	Shaft	1"
RPM	3,400	HP	8-13
GPM	4.0	Motor	Gas

FEATURES

Bolts-on a 1" gas engine shaft.
Pre-installed adjustable unloader and thermal relief valve.
Includes 3-feet of soap tubing with filter.
Made of anodized die-cast aluminum to prevent corrosion.
Includes adapters for universal connections to accessories.

SPECIALTY CLEANING

14" FLAT SURFACE CLEANER MULTI-USE



Part#	PK-1400WAW
Max. Flow	4.0 GPM
Max .Pressure	4,000 PSI (Optimal use < 2500 PSI)
Max. Temp.	180°F

APPLICATIONS

Attach to a long wand and clean hard to reach surfaces.

Attach to a gun and lance for cleaning flat surfaces.

Use a high pressure spray gun kit to clean walls.*



FEATURES

4,000 PSI maximum rotary head. (Optimal use < 2500 PSI)
Durable nylon brush skirt.
Heavy duty polypropylene cover.
Welded steel two arm rotary bar.
Zero wall clearance.

16" FLAT SURFACE CLEANER STAND-UP



Part#	8102.2401.00
Max. Flow	8.0 GPM
Max. Pressure	4,000 PSI
Max. Temp.	180°F

FEATURES

Easy to handle frame is designed for less operator fatigue.
Welded steel two arm rotary bar.
Heavy duty polypropylene cover.
Welded elbows and assembly.
Durable nylon brush skirt.
Zero wall clearance & water flow out eliminates water build-up.

SANDBLAST KIT



Part#	SBK-400
Max Pressure	3,500 PSI
Max Flow	10 GPM

FEATURES

Sandblast without the dust of regular sandblasting.
Use to strip paint, remove rust, graffiti, & stains.
Use dry silica sand or #1 grit sand.
Comes with a carbide nozzle for increased durability.
Full color retail box included.

TELESCOPING

WAND & ACCESSORIES

TELESCOPING WANDS



Easily clean gutters, rooftops and hard to reach areas.



Threaded gun for quick removal and easy field repair.



Two aluminum poles and fiberglass outer pole for maximum strength.



Lever locks for firm hold while extended.



Screw type connection for a solid grip on accessories.



Part#	Max Pressure	Max Flow	Max Temp.	Length	Hose	Weight
PK-85206012	4,000 PSI	8 GPM	200°F	6ft. 6" to 12ft.	1/4"	6.5 lbs
PK-85206018	4,000 PSI	8 GPM	200°F	6ft. 6" to 18ft.	1/4"	8.5 lbs
PK-85206024L	4,000 PSI	8 GPM	200°F	9ft. to 24ft.	1/4"	10.5 lbs

TELESCOPING WAND BELT KIT



Part#	Description
PK-85400019	Fits all Valley Long Wands Used to support Long Wands, taking stress off the arms and body. For use with all Long Wands. Fits any size (adjustable).

TELESCOPING WAND GUTTER CLEANER KITS



Part#	8102.1653.00		
Part#	PK-85400033	PK-85400007	PK-15000002
Max Pressure	4,000 PSI	4,000 PSI	4,000 PSI
Outlet	1/4" QC coupler	1/4" QC coupler	1/4" QC coupler
Inlet	Male M22	1/4" plug	1/4" Plug
Turns wands into efficient gutter cleaners so that gutters can be cleaned from the ground.			

PRESSURE WASHER SPRAY GUNS



**3200 PSI
SPRAY GUN**
TRIGGER, FRONT ENTRY

Part#	PK-12000001
Part#	SG-727
Max Pressure	3,200 PSI
Max Temperature	210° F
Max Flow	10.5 GPM
Outlet	1/4" FNPT
Inlet	3/8" FNPT



**5000 PSI
SPRAY GUN**
TRIGGER, WITH FITTINGS

Use with
2,000 - 5,000 PSI
Pressure washers!

Part#	PK-85202108
Max Pressure	5,000 PSI
Max Temperature	210° F
Max Flow	10.5 GPM
Outlet	1/4" FNPT
Inlet	3/8" FNPT



**5000 PSI
SPRAY GUN**
TRIGGER

Part#	PK-SG-970
Part#	8116.1600.00
Max Pressure	5,000 PSI
Max Temperature	300° F
Max Flow	10.5 GPM
Outlet	1/4" FNPT
Inlet	3/8" FNPT



**5000 PSI
SPRAY GUN**
TRIGGER, WITH FITTINGS

Part#	PK-1200000M
Max Pressure	5,000 PSI
Max Temperature	210° F
Max Flow	10.5 GPM
Outlet	1/4" FNPT
Inlet	3/8" FNPT

**4000 & 4050 PSI
SPRAY GUN**
TRIGGER



SG-920



SG-920V

Part#	N/A	PK-SG-920V
Part#	8108.8617.00	SG-920V
Max Pressure	4,050 PSI	4,000 PSI
Max Temperature	320° F	210° F
Max Flow	6.3 GPM	10.5 GPM
Outlet	1/4" FNPT	1/4" FNPT
Inlet	3/8" FNPT	3/8" FNPT
Ideal for Hot and Cold water applications.		

**PROFESSIONAL
SPRAY GUN
KIT**



COMPLETE KIT COMES WITH NOZZLES & FITTINGS!

Part#	PK-340002
Two piece steel lance.	
5,000 PSI rear entry spray gun.	
Size 030 - 0°, 15°, 40°, & chemical nozzle.	
Male screw-type socket for hose connection.	
3/8" quick connect coupler for hose connection.	

SPRAY GUN

4000 PSI SPRAY GUN LANCE & FITTINGS



Part#	PK-SG-850XM
Max Pressure	4,000 PSI
Max Temperature	300° F
Max Flow	8.0 GPM
Outlet	1/4" QC Coupler
Inlet	3/8" FNPT

FEATURES

- Extended lance with quick connect coupler.
- Includes fittings for universal connection to pressure washer hose:
 - 3/8" QC x MNPT
 - M22 x 3/8" MNPT
 - 1/4" FBSPP x 3/8" MNPT

5000 PSI SPRAY GUN TRIGGER WITH FITTINGS



Part#	SG-750XU-FT
Max Pressure	5,000 PSI
Max Temperature	210° F
Max Flow	10.5GPM
Outlet	M22 Screw-Type Socket
Inlet	3/8" FNPT

Comes with 3/8" male QC plug and male screw-type adapters.

PRESSURE WASHER SPRAY GUN KIT GAS



COMPLETE KIT COMES WITH THE FOLLOWING NOZZLES & FITTINGS!

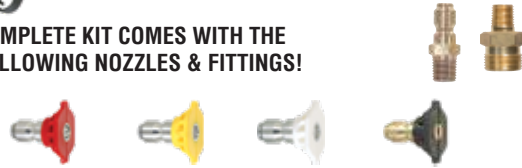

Part#	PK-340001
Max Pressure	2,950 PSI
Max Temperature	140° F
Outlet	1/4" QC Coupler
Inlet	3/8" FNPT

FEATURES

- Extended lance with quick connect coupler.
- Comes complete with 0°, 15°, 40°, and soap nozzles.
- 3/8" QC coupler and M22 screw-type plug for hose connections.
- For gas pressure washers.

PRESSURE WASHER SPRAY GUN KIT ELECTRIC



Part#	PK-340000
Max Pressure	2,500 PSI
Max Temperature	140° F
Outlet	Female M22
Inlet	Male M22 Screw-Type

FEATURES

- Extended lance with variable nozzle.
- 25-feet of reinforced steel-wire and fabric hose.
- Soap container also included.

MOLDED WAND WITH COUPLER



Part#	MG-18CA	MG-24CA	MG-36CA	MG-47CA	MG-58CA
Length	18" (450 mm)	24" (610 mm)	36" (914 mm)	47" (1200 mm)	58" (1475 mm)
Outlet	1/4" QC Coupler	1/4" QC Coupler	1/4" QC Coupler	1/4" QC Coupler	1/4" QC Coupler
Inlet	1/4" MNPT	1/4" MNPT	1/4" MNPT	1/4" MNPT	1/4" MNPT

FEATURES

- Plated steel lance with insulated grip.
- For use with hot or cold pressure washers.

Comes with quick connect coupler.

KITS & WANDS



MOLDED WAND 30° ANGLE WITH COUPLER

Part#	MG-28BCA	MG-36BCA	MG-59BCA	MG-79BCA
Length	28" (700 mm)	36" (900 mm)	59" (1500 mm)	79" (2000 mm)
Outlet	1/4" QC Coupler	1/4" QC Coupler	1/4" QC Coupler	1/4" QC Coupler
Inlet	1/4" MNPT	1/4" MNPT	1/4" MNPT	1/4" MNPT

FEATURES

Plated steel lance with insulated grip
For use with hot or cold pressure washers.

30° angled end with quick connect coupler.



FLEX WAND

Part#	PK-13000002	8102.1900.00
Length	24"	24"
Outlet	1/4" MNPT	1/4" MNPT
Inlet	1/4" MNPT	1/4" MNPT
Color	Blue Rubber Casing	Black Rubber Casing

SPRAY GUN KIT PRESSURE WASHER 4000 PSI



Part#	PK-85205026
Length	36" (900 mm)
Outlet	1/4" QC Coupler
Inlet	1/4" MNPT
PSI	4,000

FEATURES

Plated steel lance w/insulated grip.
Comes with quick connect coupler.
For use with hot or cold water.
Trigger spray gun.

WAND & NOZZLE PRESSURE WASHER VARIABLE



Part#	TP-VNW18-FT
Length	18" (450 mm)
Outlet	Variable Nozzle
Inlet	Male M22
PSI	3,000

FEATURES

Chrome plated steel lance.
Comes with quick connect coupler.
For use with hot or cold water.
140° F maximum temperature.

EXTENSIONS WAND QCxM22



Part#	TP-QCW16-FT	TP-QCW25-FT
Length	16"	25"
Outlet	1/4" QC Coupler	1/4" QC Coupler
Inlet	M22 Screw-Type	M22 Screw-Type

EXTENSIONS MOLDED WAND MNPTxMNPT



Part#	MG-18	PK-85202026	PK-13000000
Length	18" (450 mm)	36" (900 mm)	47" (1200 mm)
Outlet	1/4" MNPT	1/4" MNPT	1/4" MNPT
Inlet	1/4" MNPT	1/4" MNPT	1/4" MNPT

QA & MEG

ZERO DEGREE QC NOZZLE



Thin, extremely powerful water stream cuts heavy deposits in a small concentrated area. Ideal for cleaning hard to reach areas (e.g. soffit and oil & grease spots).

Part#	Size
PK-85201030	030
8113.1030.00	030
PK-85201035	035
8113.1035.00	035
PK-85201040	040
8113.1040.00	040
PK-85201045	045
8113.1045.00	045
PK-85201050	050
8113.1050.00	050

15 DEGREE QC NOZZLE



Narrow water stream used to penetrate heavy deposits in a small area. Ideal for cleaning Brick, Concrete Surfaces, Retaining Walls and Sidewalks.

Part#	Size
PK-85216030	030
8113.1030.15	030
PK-85216035	035
8113.1035.15	035
PK-85216040	040
8113.1040.15	040
PK-85216045	045
8113.1045.15	045
PK-85216050	050
8113.1050.15	050

25 DEGREE QC NOZZLE



Medium water stream ideal for cleaning siding, decks, vehicles, and equipment. Ideal for cleaning Brick, Concrete Surfaces, Retaining Walls and Sidewalks.

Part#	Size
PK-85226030	030
8113.1030.25	030
PK-85226035	035
8113.1035.25	035
PK-85226040	040
8113.1040.25	040
PK-85226045	045
8113.1045.25	045
PK-85226050	050
8113.1050.25	050

40 DEGREE QC NOZZLE



Wide water stream with a sweeping spray pattern. Ideal for cleaning outdoor furniture, windows, and painted surfaces.

Part#	Size
PK-85241030	030
8113.1030.40	030
PK-85241035	035
8113.1035.40	035
PK-85241040	040
8113.1040.40	040
PK-85241045	045
8113.1045.40	045
PK-85241050	050
8113.1050.40	050

QUICK CONNECT SPRAY NOZZLE KIT

Part#	PK-SZ03SNKIT	PK-SZ04SNKIT
Size	030	040
Type	Gas 4-7 HP	Gas 9-15 HP
Part#	PK-30NZLKIT	PK-40NZLKIT
Size	030	040
Type	Pro 4-7 HP	Pro 9-15 HP

FEATURES

Quick connect nozzles kits have a 0°, 15°, 40° & Soaper Nozzle. Fits most pressure washers with a 1/4" quick connect inlet. PK-30NZLKIT & PK-40NZLKIT include nozzle clip & holder. PK-SZ03SNKIT & PK-SZ04SNKIT are clamshelled without holder.



QUICK CONNECT SOAP NOZZLE



Part#	PK-85266400
Part#	8113.3160.00
Inlet	1/4" Quick Connect
Material	Brass, Plastic #40
Weight	0.04 lbs
Used to apply soap and chemicals.	

QUICK CONNECT SOAP NOZZLE LONG RANGE



Part#	PK-85210009
Inlet	1/4" Quick Connect
SPRAY SOAP UP TO 30FT!	

NOZZLES

MATCH PSI TO DESIRED GPM FOR NOZZLE SIZE					
PSI ▶	1,000	2,000	3,000	4,000	5,000
Size	GPM ▼	GPM ▼	GPM ▼	GPM ▼	GPM ▼
030	1.50	2.12	2.60	3.00	3.35
035	1.75	2.47	3.03	3.50	3.91
040	2.00	2.83	3.46	4.00	4.47
045	2.25	3.18	3.90	4.50	5.03
050	2.50	3.54	4.33	5.00	5.59
060	3.00	4.24	5.20	6.00	6.71
070	3.50	4.95	6.06	7.00	7.83

0 DEGREE MEG NOZZLE 1/4" MNPT



Part#	Size
PK-85200030	030
PK-85200045	045

15 DEGREE MEG NOZZLE 1/4" MNPT



Part#	Size
PK-85215030	030
PK-85215040	040
PK-85215045	045
PK-85215050	050
PK-85215060	060
PK-85215070	070

25 DEGREE MEG NOZZLE 1/4" MNPT



Part#	Size
PK-85225030	030
PK-85225040	040
PK-85225045	045
PK-85225050	050
PK-85225060	060
PK-85225070	070

40 DEGREE MEG NOZZLE 1/4" MNPT



Part#	Size
PK-85240030	030
PK-85240040	040
PK-85240045	045
PK-85240050	050
PK-85240060	060
PK-85240070	070

CHEMICAL NOZZLE 1/4" MNPT



Part#	PK-85240300
Part#	8102.2610.00
Inlet	1/4" MNPT
Material	Brass
Weight	0.04 lbs
Used too apply soap and chemicals.	

MULTI-FUNCTION NOZZLE QUICK CONNECT



Simply Twist to Change Between Spray Patterns!

6 Nozzles in 1

- 0°
- 15°
- 25°
- 40°
- Rinse
- Soap

Part#	PK-85210601
Inlet	1/4" QC
Material	SST

FEATURES

- High pressure nozzle.
- Stainless steel for longer life & durability.
- Soap and rinse nozzle settings.
- 1/4" Quick connect inlet.

#3 VARIABLE NOZZLE



Part#	PK-16000000
Max Pressure	3,000 PSI
Max Flow	1.58-3.12 GPM
Size	1.05mm #3
Max Temp	140°F
Inlet	1/4" FNPT
Nozzle	Brass
Best performance with 1,000 to 3,000 PSI pressure washers.	

VARIABLE & ROTATING NOZZLES

#4 VARIABLE NOZZLE



Part#	PK-1600001
Max Pressure	3,000 PSI
Max Flow	2.00-3.44 GPM
Size	1.20mm #4
Max Temp	140°F
Inlet	1/4" FNPT
Nozzle	Brass
Best performance with 1,000 to 3,000 PSI pressure washers.	

#4.5 VARIABLE NOZZLE



Part#	PK-1600002
Max Pressure	3,000 PSI
Max Flow	2.32-3.96 GPM
Size	1.30mm #4.5
Max Temp	140°F
Inlet	1/4" FNPT
Nozzle	Brass
Best performance with 1,000 to 3,000 PSI pressure washers.	

3000 PSI ROTARY NOZZLE 1/4" FNPT



Part#	PK-85210170
Part#	8111.1440.00
Max Pressure	3,000 PSI
Max Flow	4.0 GPM
Max Temp	130°F
Inlet	1/4" FNPT
Nozzle	Brass
Best performance with 1,000 to 3,000 PSI pressure washer.	

3000 PSI ROTARY NOZZLE 1/4" QC



Part#	PK-85210180
Part#	8111.1471.00
Max Pressure	3,000 PSI
Max Flow	4.0 GPM
Max Temp	130°F
Inlet	1/4" QC
Nozzle	Ceramic
Best performance with 2,000 to 3,000 PSI pressure washer.	
Built-in easy to clean water filter extends nozzle life.	

3200 PSI ROTARY NOZZLE 1/4" QC



Part#	RJ-3030-CS
Part#	RJ-3030-QC
Max Pressure	3,000 PSI
Max Flow	3.2 GPM
Max Temp	130°F
Inlet	1/4" QC
Nozzle	Ceramic
Best performance with 2,000 to 3,000 PSI pressure washer.	

3600 PSI ROTARY NOZZLE 1/4" QC



Part#	PK-85210190
Part#	8111.1430.00
Max Pressure	3,600 PSI
Max Flow	4.0 GPM
Max Temp	130°F
Inlet	1/4" QC
Nozzle	Ceramic
Best performance with 2,500 to 3,600 PSI pressure washer.	
Built-in easy to clean water filter extends nozzle life.	

3700 PSI ROTARY NOZZLE 1/4" QC



Part#	PK-RJ-4030
Part#	8111.1432.00
Max Pressure	3,700 PSI
Max Flow	4.0 GPM
Max Temp	130°F
Inlet	1/4" QC
Nozzle	Ceramic

4800 PSI ROTARY NOZZLE 1/4" QC



Part#	PK-RJ-4048
Part#	8111.1451.00
Max Pressure	4,800 PSI
Max Flow	4.0 GPM
Max Temp	130°F
Inlet	1/4" QC
Nozzle	Ceramic
Best performance with 3,600 to 4,800 PSI pressure washer.	
Built-in easy to clean water filter extends nozzle life.	

5100 PSI ROTARY NOZZLE 1/4" QC



Part#	PK-RJ-4550
Part#	8116.1453.00
Max Pressure	5,100 PSI
Max Flow	4.0 GPM
Max Temp	130°F
Inlet	1/4" QC
Nozzle	Ceramic

PRESSURE WASHER HOSES

2600 PSI HOSE



Part#	25TPR14-MIT
Max Pressure	2,600 PSI
Diameter	1/4"
Length	25'
Max Temp	140° F

FEATURES

Reinforced with steel-wire and fabric.
Complete with M22 screw-type fitting ends.
Includes fittings that connect to Mi-T-M compatible accessories.
Compatible with electric and gas pressure washers.

3600 PSI HOSE



Part#	PK-85256126-MIT
Max Pressure	3,600 PSI
Diameter	5/16"
Length	25'
Max Temp	140°F

FEATURES

Reinforced with steel-wire and fabric.
Cut and burn resistant material.
Complete with 3/8" coupler and plug fitting ends.
Includes fittings that connect to Mi-T-M compatible accessories.
Compatible with electric and gas pressure washers.

4000 PSI HOSE



Part#	PK-85238151
Max Pressure	4,000 PSI
Diameter	3/8"
Length	50'
Max Temp	200°F

FEATURES

Reinforced with steel-wire and fabric.
Non-marking, cut and burn resistant material.
6" hose guards with bend restrictors.
Complete with 3/8" coupler and plug fitting ends.
Compatible with gas pressure washers.

4000 PSI NON-MARKING



Part#	PK-85238155
Part#	8115.0847.10
Max Pressure	4,000 PSI
Diameter	3/8"
Length	50'
Max Temp	250°F

FEATURES

Reinforced with steel-wire and fabric.
Cut and burn resistant material.
6" hose guards with bend restrictors.
Complete with 3/8" coupler and plug fitting ends.
Compatible with gas pressure washers.

PRESSURE WASHER HOSES

4000 PSI HOSE



Part#	30W1-H-BLK
Max Pressure	4,000 PSI
Diameter	3/8"
Length	30'
Max Temp	250°F

FEATURES

Steel braided rubber hose.
6" hose guards with bend restrictors.
Complete with 3/8" MNPT fitting ends.
One end with swivel fitting.
Compatible with gas pressure washers.

4000 PSI HOSE



Part#	50W1-H-BLK
Max Pressure	4,000 PSI
Diameter	3/8"
Length	50'
Max Temp	250°F

FEATURES

Steel braided rubber hose.
6" hose guards with bend restrictors.
Complete with 3/8" MNPT fitting ends.
One end with swivel fitting.
Compatible with gas pressure washers.

4000 PSI HOSE



Part#	75W1-H-BLK
Max Pressure	4,000 PSI
Diameter	3/8"
Length	75'
Max Temp	250°F

FEATURES

Steel braided rubber hose.
6" hose guards with bend restrictors.
Complete with 3/8" MNPT fitting ends.
One end with swivel fitting.
Compatible with gas pressure washers.

4000 PSI HOSE



Part#	100W1-H-BLK
Max Pressure	4,000 PSI
Diameter	3/8"
Length	100'
Max Temp	250°F

FEATURES

Steel braided rubber hose.
6" hose guards with bend restrictors.
Complete with 3/8" MNPT fitting ends.
One end with swivel fitting.
Compatible with gas pressure washers.

SCREW TYPE FITTINGS

SCREW-TYPE PLUGS MNPTxM22



Part#	PK-85300132	PK-85300133
Part#	8102.6004.00	8102.6005.00
Inlet	1/4" MNPT	3/8" MNPT
Thread	M22 x 1 1/2	M22 x 1 1/2

SCREW-TYPE COUPLER MNPTxM22



Part#	PK-85300136
Part#	8102.8521.00
Part#	8102.6020.00 (1/4" Inlet)
Inlet	3/8" MNPT
Thread	M22 x 1 1/2

SCREW-TYPE NIPPLE M22xM22



Part#	PK-14000000
Part#	8102.6006.00
Size	M22 Male x M22 Male

SCREW-TYPE COUPLER M22xM22



Part#	PK-14000001
Part#	TC-TC
Size	M22 Female x M22 Female

SCREW-TYPE SOCKET FNPTxM22



Part#	PK-14000004
Part#	8102.6001.00
Part#	8102.6000.00 (1/4" Inlet)
Inlet	3/8" FNPT
Thread	M22 x 1 1/2

SCREW-TYPE PLUGS FNPTxM22



Part#	PK-14000009	PK-14000005
Part#	8102.6002.00	8102.6003.00
Inlet	1/4" FNPT	3/8" FNPT
Thread	M22 x 1 1/2	M22 x 1 1/2

SCREW-TYPE SOCKET M22xQC



Part#	8102.8518.00
Size	M22 plug x 3/8" QC coupler

SCREW-TYPE PLUGS M22xQC



Part#	8102.8519.00
Size	M22 socket x 3/8" QC plug

SCREW-TYPE QC SET M22xQC



Part#	PK-14000006
Description	M22 plug x 3/8" QC coupler

GARDEN HOSE FITTINGS

GARDEN HOSE QC SET



Part#	PK-14000003
Coupler Size	3/4" FGHT x 1/2" QC
Plug Size	3/4" MGHT x 1/2" QC

GARDEN HOSE QC SOCKET



Part#	8102.0336.00
Size	3/4" FGHT x 1/2" QC

GARDEN HOSE QC PLUG



Part#	8102.0335.00
Size	3/4" MGHT x 1/2" QC

GARDEN HOSE ADAPTER



Part#	PK-14000010
Part#	8105.0502.00
Size	3/4" FGHT x 1/2" FNPT
Assembly includes garden hose adapter and stainless steel mesh filter.	

O-RINGS & FILTER SET



Part#	PK-14000007
Kit Contents	
14mm (x2)	3/8" (x2)
15mm (x2)	Garden Hose Filters (x2)
1/4" (x2)	(x2)

O-RINGS & FILTER SET



Part#	PK-1400000M
Kit Contents	
14mm (x2)	1/4" (x2)
15mm (x2)	3/8" (x2)
1/4" BSPP (x2)	Garden Hose Filters (x2)

O-RING SET



Part#	PK-85400200
Kit Contents	
1/4" (x4)	3/8" (x2)

BRASS LIVE SWIVEL



Part#	PK-14000008
Part#	8402.3501.00
Size	3/8" FNPT x 3/8" MNPT

BRASS REDUCER BUSHING



Part#	PK-14000002
Part#	8102.0520.00
Size	3/8" MNPT x 1/4" FNPT

SCREW-TYPE ADAPTER



Part#	8102.0533.00
Size	1/4" MBSPP x 3/8" FNPT

SCREW-TYPE PLUG



Part#	PK-81020532
Part#	8102.0532.00
Size	1/4" FBSPP x 3/8" MNPT

QUICK CONNECT FITTINGS

QUICK CONNECT PLUGS FNPTxQC



Part#	PK-85300101	PK-85300104
Part#	8102.0320.00	8102.0322.00
	8102.0328.00 (Stainless)	8102.0330.00 (Stainless)
Thread	1/4" QC x FNPT	3/8" QC x FNPT
Material	Plated Steel	Plated Steel

QUICK CONNECT PLUGS MNPTxQC



Part#	PK-85300109	PK-85300105
Part#	8102.0321.00	8102.0323.00
	8102.0329.00 (Stainless)	8102.0331.00 (Stainless)
Thread	1/4" QC x MNPT	3/8" QC x MNPT
Material	Plated Steel	Plated Steel

QUICK CONNECT COUPLERS FNPTxQC



Part#	PK-85300102	PK-85300103
Part#	8102.0301.00	8102.0302.00
	8102.0309.00 (Stainless)	8102.0310.00 (Stainless)
Thread	1/4" QC x FNPT	3/8" QC x FNPT
Material	Brass	Brass

QUICK CONNECT COUPLERS MNPTxQC



Part#	PK-85300107	PK-85300108
Part#	8102.0303.00	8102.0304.00
	8102.0311.00 (Stainless)	8102.0312.00 (Stainless)
Thread	1/4" QC x MNPT	3/8" QC x MNPT
Material	Brass	Brass

3/8" QUICK CONNECT COUPLER KIT



Part#	PK-85400201
Kit Contents	3/8" QC x FNPT plated steel plug 3/8" QC x FNPT brass coupler

1/4" & 3/8" QUICK CONNECT COUPLER KIT



1/4" QUICK CONNECT COUPLER KIT



Part#	PK-14000202
Kit Contents	1/4" QC x MNPT plated steel plug 1/4" QC x FNPT brass coupler

Part#	PK-85400202
Kit Contents	1/4" QC x FNPT plated steel plug 1/4" QC x FNPT brass coupler 3/8" QC x FNPT plated steel plug 3/8" QC x FNPT brass coupler

QUICK CONNECT FITTINGS

1/2" QUICK CONNECT COUPLERS



Part#	8102.0357.00 (Brass)	8102.0356.00 (Brass)
	QC-308SS (Stainless)	QC-308MSS (Stainless)
Thread	1/2" QC Coupler x FNPT	1/2" QC Coupler x MNPT

1/2" QUICK CONNECT PLUGS



Part#	8102.0355.00 (Plated Steel)	8102.0354.00 (Plated Steel)
	QC-318SS (Stainless)	QC-318MSS (Stainless)
Thread	1/2" QC Plug x FNPT	1/2" QC Plug x MNPT

90° PIVOT COUPLER QUICK CONNECT



Part#	PK-85300172
Part#	QC-304P
Description	Brass Male QC Plug and Coupler with 90 Degree Pivot

CHEMICAL HOSE ASSEMBLY



Part#	PK-15000000
Part#	8102.3000.00
Length	3'
Comes with 3 ft hose & chemical suction filter.	

INLET FILTER CLEAR BOWL



Part#	PK-85300055
Part#	8102.0461.00
Max Flow	8 GPM
Max Temperature	175°F
Inlet	3/4" FGHT
Outlet	1/2" MNPT
Port	Dual 1/4" FNPT with plugs
Protects the pump for contaminants in the water. Clear bowl to easily view filter.	

CHEMICAL INJECTOR KITS



Part#	PK-85400003	PK-85400001
Part#	85400003	CHEMK-DN
Description	High Pressure Up Stream Injector	Low Pressure Down Stream Injector
Max Pressure	3,500 PSI	3,500 PSI
Max Temperature	180°F	180°F
Max Flow	8 GPM	3.5 GPM
Used to provide chemical discharge at pressure washers maximum pressure.		

PRESSURE WASHER ACCESSORIES



← PRESSURE GAUGE 2.5" KIT

Part#	PK-QCG-5000
Max Pressure	5,000 PSI
Size	2.5"
Inlet	3/8" QC plug
Outlet	3/8" QC coupler

Accurately view pressure for all units up to 5,000 PSI.



← PREMIUM PUMP OIL 32 OZ

Part#	PK-85490000
FEATURES	<ul style="list-style-type: none"> Heavy-duty synthetic oil formula to keep pump running smooth. Non-detergent & non-foaming for superior oxidation protection. Simplified pouring with easy fill neck. Compatible with Comet and other industrial pumps.



← SAE 10W-30 MOTOR OIL 32 OZ

Part#	PK-85490002
FEATURES	<ul style="list-style-type: none"> Heavy-duty synthetic oil formula for better wear control. Advanced additives for broad temperature ranges. Simplified pouring with easy fill neck. Compatible with wide range of 4-cycle gas engines.

← SUCTION FILTERS 1/4" HOSE BARB



Low pressure soap suction filters keep contaminants from entering your pump.

Part#	CF-GREY	CF-BLKSS
Hose Barb	1/4"	1/4"
Check Valve	Yes	No
Finish	Plastic	Plastic



← PUMP SAVER ANTIFREEZE 16 OZ

Part#	PK-85490046
FEATURES	<ul style="list-style-type: none"> Lubricates and conditions pump, seals, and extends pump life. Protects your pump from freezing over the winter.

← PRESSURE WASHER STARTER KIT



Part#	PK-PWKIT
Kit Contents	<ul style="list-style-type: none"> 32oz. Pump Oil 32oz. Motor Oil 16oz. Pump Saver Nozzle Holder Garden Hose Adapter

PRESSURE WASHER

ACCESSORIES

INLET FILTER WATER



Part#	PK-85300058
Part#	8102.0401.00
Max Flow	10 GPM
Max Temperature	180°F
Inlet	3/4" FGHT
Outlet	1/2" MNPT
Ports	Dual 1/4" FNPT with plugs
Protects the pump for contaminants in the water. Cap easily unscrews with an allen key to clean out screen.	

GARDEN HOSE ADAPTER QUICK CONNECT



Part#	GHF-QC-BLU
FEATURES	
Connects garden hose to inlet of pressure washer. Built-in filter protects from unwanted debris. Quick attach setup for hassle free attachment. Compatible with most electric pressure washers.	

24 VOLT WIRE HARNESS EYELET CONNECTORS



Part#	33-103947-BOX
Length	6 Feet
Gauge	12
Volts	24
Fuse	30 Amp
Connections	SAE, 2-Pin & Battery Eyelet

FOAM CANNON QUICK CONNECT



Part#	FMR-5000
Max Pressure	5000 PSI
FEATURES	
Adjustable nozzle goes from steady stream to wide-angle pattern. Water regulator knob that controls thickness of foam. Translucent liter bottle with raised volume markings. Wide mouth opening for easy filling. Includes connection fittings to connect with spray guns and lances.	

SOFT WASH

Visit www.everflo.com for more info.

MOTOR SHIELD PROTECTION

Exclusive patent-pending Motor Shield technology automatically shuts the pump off if a leak is detected. This protects the motor from damage and allows for an easy and low-cost pump head replacement.

SOFT WASH PUMP
2.2 GPM



Part#	Port Type	Packaging
EFSW2200-BOX	Quick Attach	Boxed
EFSW2200CT	Replacement Head Kit for EFSW2200-BOX	

FEATURES

70 PSI	Polypropylene Housing & Valve Plate
8.0 Max Amps	Zinc Plated Steel Fasteners
Self Priming to 8'	Painted Steel 5" Motor Shell
CE Approved	QA x 3/8" HB & QA x 1/2" MNPT Fittings
Auto Shut-Off	Motor Shield Protection

SOFT WASH PUMP
4.0 GPM



Part#	Port Type	Packaging
EFSW4000-BOX	Quick Attach	Boxed
EFSW4000CT	Replacement Head Kit for EFSW4000-BOX	

FEATURES

60 PSI	Polypropylene Housing & Valve Plate
13.0 Max Amps	Zinc Plated Steel Fasteners
Self Priming to 12'	Painted Steel 5" Motor Shell
CE Approved	QA x 1/2" HB & QA x 1/2" MNPT Fittings
Auto Shut-Off	Motor Shield Protection

SOFT WASH PUMP
5.5 GPM



Part#	Port Type	Packaging
EFSW5500-BOX	Quick Attach	Boxed
EFSW5500CT	Replacement Head Kit for EFSW5500-BOX	

FEATURES

60 PSI	Polypropylene Housing & Valve Plate
17.0 Max Amps	Zinc Plated Steel Fasteners
Self Priming to 12'	Painted Steel 5" Motor Shell
CE Approved	QA x 3/4" HB & QA x 1/2" MNPT Fittings
Auto Shut-Off	Motor Shield Protection

SOFT WASH PUMP
10.0 GPM



Part#	Port Type	Packaging
EFSW10000-BOX	Quick Attach	Boxed
EFSW10000CT	Replacement Head Kit for EFSW10000-BOX	

FEATURES

100 PSI	Polypropylene Housing & Valve Plate
25.0 Max Amps	Zinc Plated Steel Fasteners
Self Priming to 10'	Painted Steel 5" Motor Shell
CE Approved	Fittings & Plumbing Included
Auto Shut-Off	Motor Shield Protection

SOFT WASH

12 GALLON SOFT WASH
SPRAYER
 RECHARGEABLE



FEATURES SWI-09-012S-VI

- Lead-acid rechargeable battery.
- 12 gallon chemical resistant tank.
- 2.2 GPM Everflo pump offers 70 PSI
- Powder coated, all-steel frame.
- All-steel hose organizing rack.
- Rugged, never-flat wheels.
- Deluxe, quick-connect spray gun.
- 30' of chemical resistant braided nylon hose.
- Raised volume indicators for easy filling and fluid monitoring.
- Motor Shield Protection shuts pump off if a leak is detected.
- 5" recessed screw-on fill lid with tether for less spillage.
- Battery charger included.
- Mold-in drain with tethered cap.



SOFT WASH
SPRAY GUN
 (SOLD SEPARATELY)



Part#	Description
8108.7212.00	Soft Wash Spray Gun w/QA Outlet
FEATURES	
217 PSI Max	31.2 GPM Max 24" Barrel Length
125° F Max	1/2" FPT Inlet 1/4" Female QC Outlet
Part#	Description
8108.7212.01	Rebuild Kit for 8108.7212.00

SYSTEMS



BATCHPRO™ SOFT WASH SYSTEM

FEATURES SW3-T5-FUA

- 100 Gallon water tank and 55 gallon chemical & mix tanks.
- 11 GPM 300 PSI Comet® P40 diaphragm pump.
- Heavy-duty welded aluminum frame.
- Reliable electric ball valves.
- Pre-plumbed & labeled control panel.
- Long-distance spray gun with nozzle kit.
- Chemical resistant vinyl plumbing.
- Powered by Honda® GX200 engine with electric start.
- Heavy-duty 18" electric hose reel.
- 200' of 5/8" hose & heavy-duty hose guides.
- Stainless steel soap injector.
- Lead-Acid rechargeable battery.
- DOT Compliant.



The BatchPro™ Softwash System bridges the gap between metering and batching for Softwash applications. This system increases productivity by allowing you to easily mix any batch, on the job, with the push of a button.

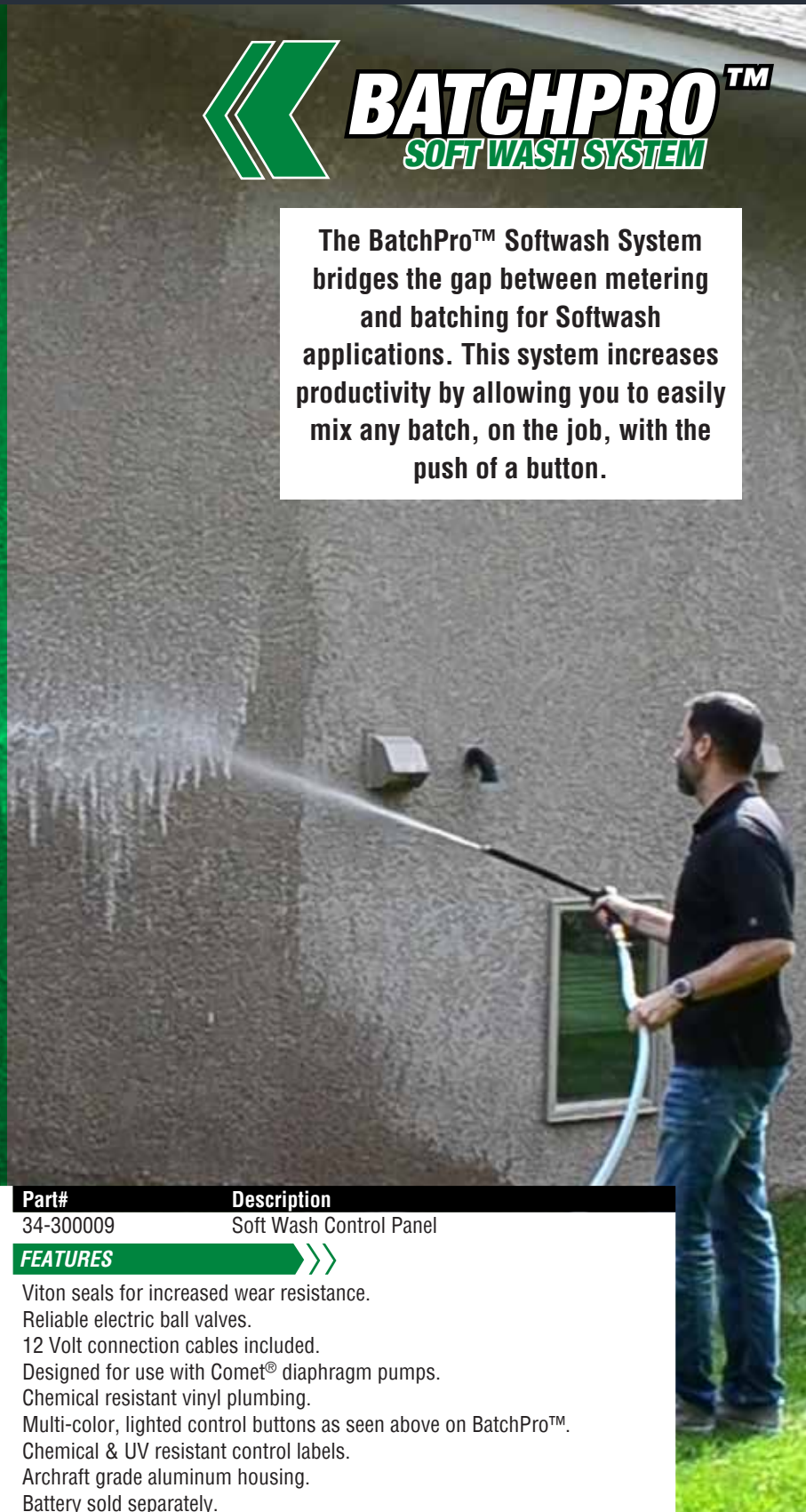

SOFT WASH CONTROL PANEL (SOLD SEPARATELY)



Part#

34-300009

Description

Soft Wash Control Panel

FEATURES

- Viton seals for increased wear resistance.
- Reliable electric ball valves.
- 12 Volt connection cables included.
- Designed for use with Comet® diaphragm pumps.
- Chemical resistant vinyl plumbing.
- Multi-color, lighted control buttons as seen above on BatchPro™.
- Chemical & UV resistant control labels.
- Aircraft grade aluminum housing.
- Battery sold separately.

RECHARGEABLE DISINFECTANT

SPRAYER



FEATURES SW6-09-012N-VI

- 12 gallon chemical resistant tank.
- 1.1 gpm Everflo pump offers 40PSI.
- Rechargeable 14.4 volt lithium-ion battery.
- Powder coated, all-steel frame.
- All-steel hose organizing rack.
- Rugged, never-flat wheels.
- Quick-grip misting spray gun.
- 30' of chemical resistant braided nylon hose.
- Raised volume indicators for easy filling and fluid monitoring.
- Up to 30 gallons on a single charge.
- 5" recessed screw-on fill lid with tether for less spillage.
- Battery charger included.
- Mold-in drain with tethered cap.

PRESSURE WASHERS



ELECTRIC RESIDENTIAL PRESSURE WASHER 1.5 HP & 1500 PSI

Engine	Powerase Electric
HP	1.5 HP
PSI	1500
Max Flow	1.6 GPM
Mount	Wall Mount
Other Features:	Commercial Grade Steel Frame Triplex Brass Head Pump Auto On/Off w/Trigger Activation 50' Steel Braided Rubber Hose 36" Insulated Lance 4 QC Spray Tips

Powerase
engines



GASOLINE FARM & RANCH PRESSURE WASHER 7.0 HP & 3100 PSI

Engine	Powerase
HP	7.0 HP
PSI	3100
Max Flow	2.3 GPM
Drive	Horizontal
Other Features:	10" Tires Chemical Injector 25' Rubber Hose 36" Insulated Lance 4 QC Spray Tips Steel Powder Coated Frame

Powerase
engines



PRESSURE **WASHERS**



INDUSTRIAL GASOLINE **PRESSURE WASHER**

9.0 HP & 3800 PSI

Engine	Honda GX270 Series
HP	9.0 HP
PSI	3800
Max Flow	3.5 GPM
Drive	Horizontal
Other Features:	Threaded Axle 13" Pneumatic Tires 50' Steel Braided Rubber Hose 36" Insulated Lance 4 QC Spray Tips Commercial Grade Steel Powder Coated Frame

POWERED by **HONDA**



INDUSTRIAL GASOLINE **PRESSURE WASHER**

15.0 HP & 4000 PSI

Engine	Powercase w/Oil Alert
HP	15.0 HP
PSI	4000
Max Flow	4.0 GPM
Drive	Horizontal
Other Features:	Threaded Axle 13" Pneumatic Tires Chemical Injector 50' Steel Braided Rubber Hose 36" Insulated Lance 4 QC Spray Tips Commercial Grade Steel Powder Coated Frame

Powercase
engines



WATER PUMPS

5.0 HP & 158 GPM WATER PUMP



FEATURES

Output Diameter	2 Inch
Engine	6.5 HP Honda GX
Max Flow	158 GPM
Start Type	Pull Start

6.5 HP & 126 GPM WATER PUMP



FEATURES

Output Diameter	2 Inch
Engine	6.5 HP Honda GX
Max Flow	126 GPM
Start Type	Pull Start

7.0 HP & 158 GPM WATER PUMP



FEATURES

Output Diameter	2 Inch
Engine	7.0 HP Powerease
Max Flow	158 GPM
Start Type	Pull Start
C.A.R.B. Approved Engine Also Available.	

WATER & TRASH PUMPS

WATER PUMP

6.5 HP & 264 GPM



FEATURES

Output Diameter	3 Inch
Engine	6.5 HP Honda
Max Flow	264 GPM
Start Type	Pull Start

WATER PUMP

7.0 HP & 264 GPM



FEATURES

Output Diameter	3 Inch
Engine	7.0 HP Powerase
Max Flow	264 GPM
Start Type	Pull Start
C.A.R.B. Approved Engine Also Available.	

WATER PUMP

8.0 HP & 286 GPM



FEATURES

Output Diameter	3 Inch
Engine	8.0 HP Honda
Max Flow	286 GPM
Start Type	Pull Start

WATER PUMP

13.0 HP & 506 GPM



FEATURES

Output Diameter	4 Inch
Engine	13.0 HP Honda
Max Flow	506 GPM
Start Type	Pull Start

GASOLINE GENERATORS

GENERATOR FEATURES

223CC 4200 Watt	OHV Engine, Electric Start, Low Oil Shutdown, Auto Idle Down, Circuit Breakers, Fuel Gauge, Wheel Kit Standard, 1 Year Engine Warranty, 1 Year Generator Warranty, EPA Approved, CARB Approved, Voltmeter, Automatic Voltage Regulator
390CC 6500 Watt	OHV Engine, Electric Start, Low Oil Shutdown, Auto Idle Down, Circuit Breakers, Fuel Gauge, Wheel Kit Standard, 1 Year Engine Warranty, 1 Year Generator Warranty, EPA Approved, CARB Approved, Voltmeter, Stainless Steel Control Panel, Automatic Voltage Regulator
420CC 9000 Watt	OHV Engine, Electric Start, Low Oil Shutdown, Auto Idle Down, Circuit Breakers, Fuel Gauge, Wheel Kit Standard, 1 Year Engine Warranty, 1 Year Generator Warranty, EPA Approved, CARB Approved, Voltmeter, Automatic Voltage Regulator

4200 WATT GENERATOR 223CC



SPECIFICATIONS

Engine	Powerease
Displacement	223cc
AC Max Output	4200 watt
AC Max Continuous Output	3500 watt
Receptacles	4 x 120V Household 1 x 120V 30A Twistlock
DC Output	12V * 8.3A
Starting System	Electric Start
Fuel Tank Capacity	3.9 Gallons
Run Time per Tankful	9 h @ full load
Noise Level @ 7m	70db
Weight	120lbs

6500 WATT GENERATOR 390CC



Includes 8" Wheel Kit!

SPECIFICATIONS

Engine	Powerease OHV
Displacement	390cc
AC Max Output	6500 watt
AC Max Continuous Output	5500 watt
Receptacles	2 x 120V 20A Duplex 1 x 120V Twistlock 1 x 240V Twistlock
DC Output	12V * 8.3A
Starting System	Electric Start
Fuel Tank Capacity	6.6 Gallons
Run Time per Tankful	7h @ full load
Noise Level @ 7m	74db
Weight	209lbs

9000 WATT GENERATOR 420CC



Includes 8" Wheel Kit!

SPECIFICATIONS

Engine	Powerease OHV, 15HP
Displacement	420cc
AC Max Output	9000 watt
AC Max Continuous Output	7100 watt
Receptacles	3 x 120V 20A Duplex 1 x 120V Twistlock 1 x 240V Twistlock
DC Output	12V * 8.3A
Starting System	Electric Start
Fuel Tank Capacity	6.6 Gallons
Run Time per Tankful	6.5h @ full load
Noise Level @ 7m	78db
Weight	225lbs

WARRANTY

& RETURN INFORMATION

WARRANTY

This warranty is in lieu of all other warranties, expressed or implied. Valley Industries warrants that all products sold shall be free from defects in workmanship and material when used within the service and scope for which they were designed.

Such warranty shall apply for a period of one year after the shipment of the product unless otherwise noted. If at any time within this period, it is established to the satisfaction of Valley Industries that the product was defective at time of shipment, Valley Industries, at its option, shall furnish replacements of, or repair the product(s).

It is understood that the liability of Valley Industries shall be limited to such repair or replacement and that Valley Industries shall not be liable for any direct or consequential damages arising out of any defects or from any cause whatsoever. This warranty does not cover deterioration by normal wear and tear or any other cause of failure other than defects in workmanship and material as previously outlined.

Unless repairs to, alterations of, or work done on the product by the purchaser is specifically authorized in writing by Valley Industries, any warranty applicable to the product shall become null and void.

RETURNED GOODS

Valley Industries will make every effort possible to rectify errors which result in items being returned for credit. Valley Industries requires a return authorization number and a copy of the packing list with all returned goods.

A restocking charge may apply.

Our goal is to provide you with prompt and correct credit or replacement. Special Order Products may not be returned.

SPECIFICATIONS

The design specifications found within this catalog are subject to change without notice.

PRODUCT FEATURES AND AVAILABILITY SUBJECT TO CHANGE WITHOUT NOTICE



Agricultural Sprayers, Accessories & Components.

www.master-mfg.com



Diaphragm and High Pressure Plunger Pumps & Accessories.

www.cometpump.com



12 Volt DC Diaphragm Pumps & Accessories.

www.everflopump.com



Agricultural Mist Sprayers & Accessories.

www.mistsprayers.com

BESTWAY AG

Professional Ag Sprayers, Attachments, & Accessories.

www.bestwayag.com

