

# 2024 CATALOG

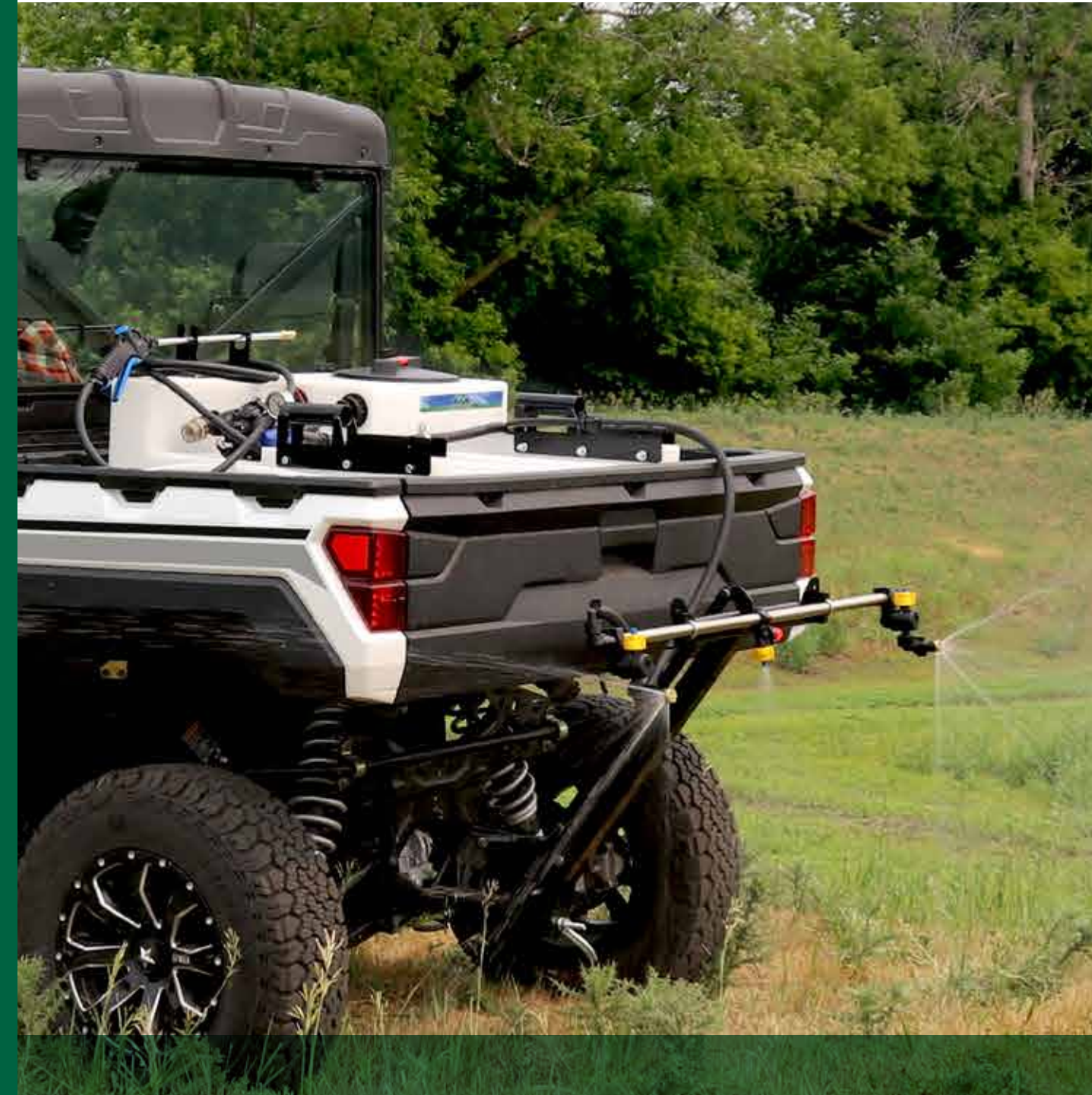

# TABLE OF CONTENTS

- 3. Information
- 6. Grass Guardian Sprayers
- 12. Li-Ion Powered
- 18. Home & Garden
- 20. Spot
- 26. ATV
- 28. Trailer
- 36. Skid
- 40. UTV
- 42. 3-Point
- 46. High Pressure
- 48. Specialty
- 52. Professional
- 54. Boom Mounting System
- 56. Booms
- 58. Everflo Pumps
- 60. Nozzles
- 62. Accessories
- 72. Bulk Tanks
- 73. Nozzle Charts

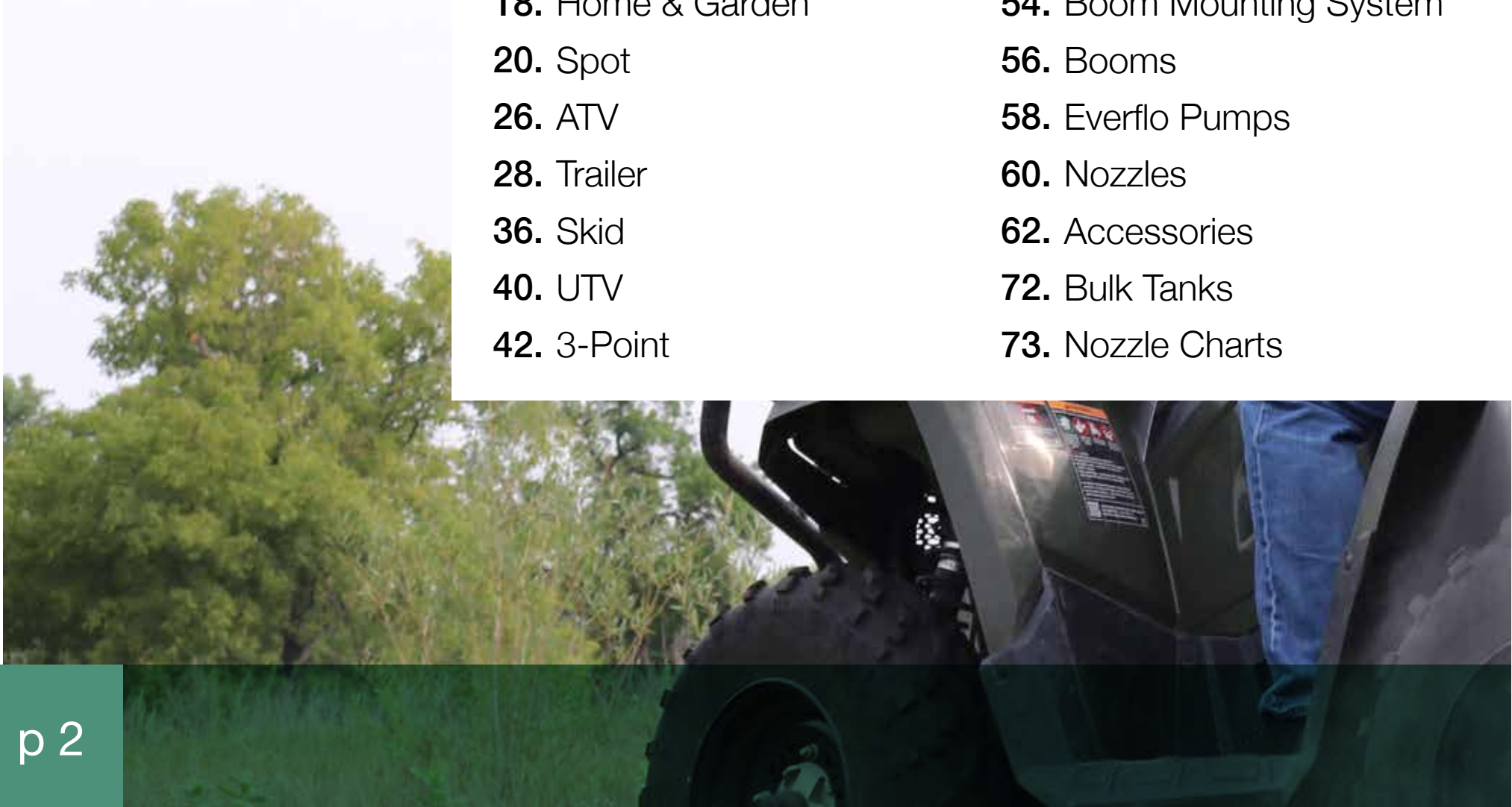



## VALLEY INDUSTRIES

Originally started as a pressure gauge and accessory distributor, Valley Industries has grown and evolved in its role as a leader in the agricultural and industrial markets. Today, Valley Industries manufactures and distributes thousands of products, across several categories and brands, that continue to set the bar in performance and quality.

## MASTER MANUFACTURING

In 2006, Valley Industries acquired Master Manufacturing. Starting off with a handful of spot sprayers, Master Manufacturing has grown to encompass a wide range of spot & broadcast sprayers that can be used across lawn & garden or agricultural spraying applications.

## MASTER MFG CAPABILITIES

- Internal engineering team that develops new concepts and solutions.
- Blow mold tank designs up to 60 gallons with integrated robotic processes.
- Equipped with lasers, press brake and welding stations for custom components.
- Complete domestic assembly and packaging, run on multiple lines.
- Private label program for both in-store and e-commerce channels.



# SPRAYER BASICS

All Master Manufacturing Spot & Broadcast Sprayers are built on a key set of rugged and durable features that last season after season. See some of standard features you can find on Master Manufacturing Sprayers!

## ADDITIONAL FEATURES

- DRAIN PORT WITH TETHERED CAP & GASKET
- 12-VOLT WIRE HARNESS WITH ALLIGATOR CLAMPS
- GUN CLIPS FOR SPRAY GUN STORAGE
- EZ-GRIP CARRY HANDLES MOLDED INTO TANK
- THREADED INSERTS IN STANDARD MOUNTING PATTERN

### LID

6" TANK LID WITH TETHER FOR EASY FILLING.

### INLINE STRAINER

CLEAR BOWL INLINE STRAINER TO PREVENT PUMP DEBRIS.

### PUMP

12-VOLT ON-DEMAND EVERFLO DIAPHRAGM PUMP FOR FAST PRIMES.

### TANK

EXTRA-THICK TRANSLUCENT WALLS THAT ARE CHEMICAL AND UV RESISTANT.

### SPRAY GUN

SPRAY GUN WITH ADJUSTABLE NOZZLE THAT GOES FROM STEADY STREAM TO MIST.

### HOSE

15 FEET OF 3/8" RUBBER HOSE FOR MORE REACH.



# SPRAYER BASICS

## PRESSURE GAUGE

HELPS YOU DIAL IN THE PERFECT PRESSURE FOR ANY APPLICATION.

## BOOM SHUT-OFF

EASY TO REACH SHUT-OFF VALVE FOR COMPLETE BOOM CONTROL.

## HOSE STRAP

HOOK & LOOP STRAP KEEPS HOSE ORGANIZED AND OUT OF THE WAY.

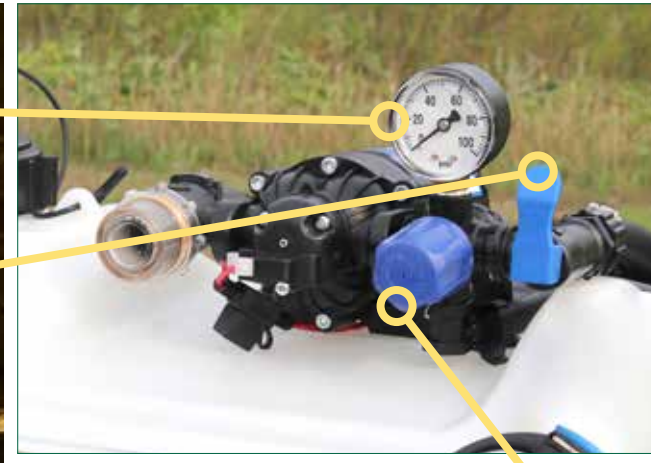

## PRESSURE REGULATOR

ADJUST YOUR SYSTEM'S PRESSURE WITH A SIMPLE TWIST OF THE KNOB.

## SPRAY BOOM

AVAILABLE IN A VARIETY OF SIZES, SPRAY PATTERNS, SPACING OPTIONS, AND NOZZLE STYLES.

## MOUNT OR TRAILER

WE OFFER VARIETY OF MOUNTING SYSTEMS, FROM ATVS TO 3-POINTS AND TRAILERS, TO FIT ANY NEED.

SPRAYER: S30-51-040D-MM

\* MASTER MANUFACTURING SPRAYERS COME WITH A 2-YEAR LIMITED WARRANTY ON MANUFACTURING DEFECTS IN PUMP & COMPONENTS.

# ATV SPRAYERS 15/25 GALLON

**GRASS**  **GUARDIAN**

	Part #	Pump	Boom	Swath	Capacity	Carton Size	Weight	UPC	Pallet Qty	UPS Ship	Freight Class
<b>15/25 GALLON</b>	EAI-11-015A-GG	Everflo 1.1 GPM	Dual Deflector Nozzles	7'	15 Gal	35" x 17" x 15"	27 lbs	810044042573	18	Yes	150
	EAI-11-025A-GG	Everflo 1.1 GPM	Dual Deflector Nozzles	7'	25 Gal	36" x 19" x 19"	34 lbs	810044042580	15	Yes	150

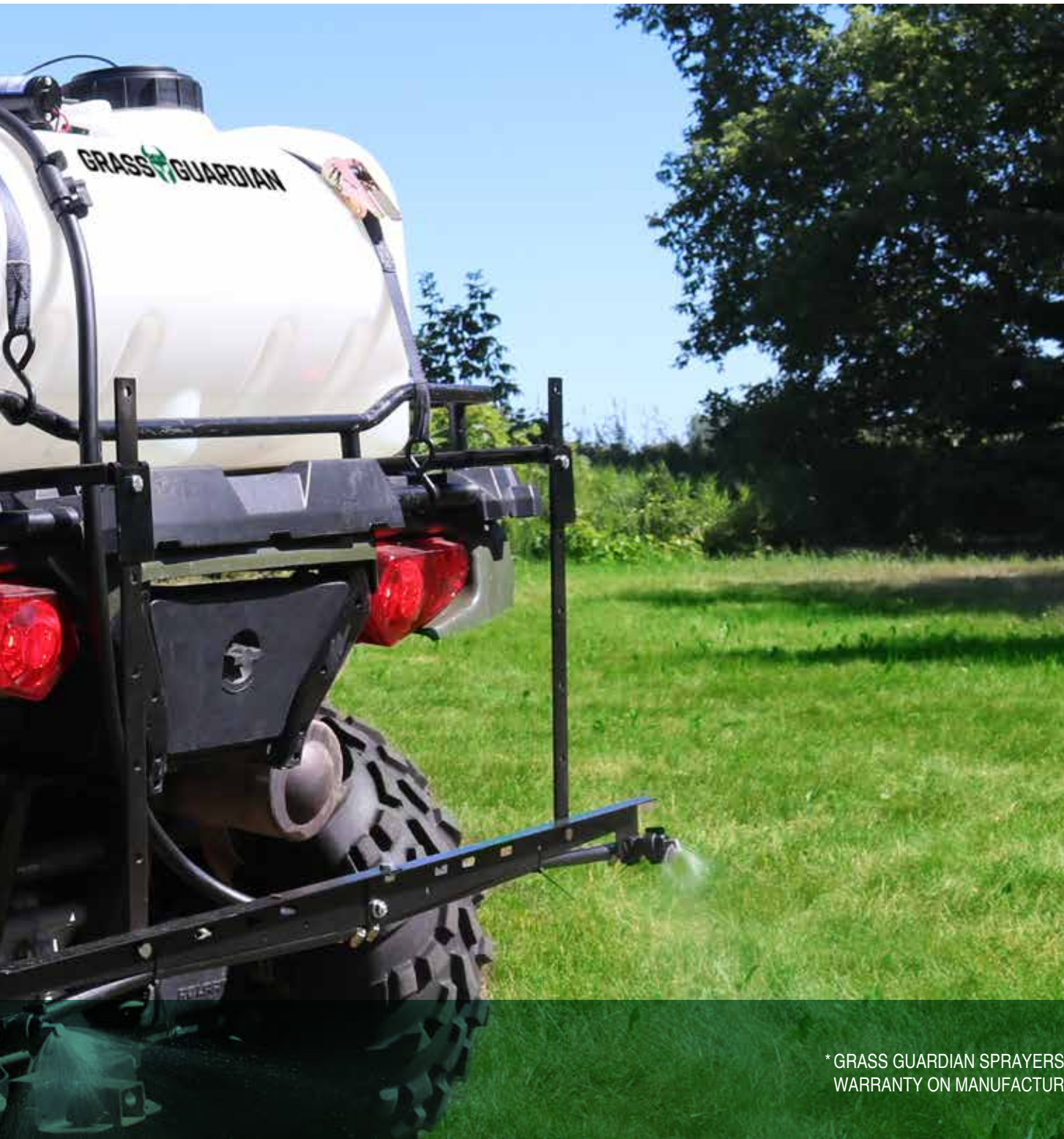

# FEATURED SPRAYER



EAI-11-025A-GG

## FEATURES

- ADJUSTABLE SPRAY GUN
- INLINE BOOM SHUT-OFF VALVE
- 1.1 GPM EVERFLO 12 VOLT DIAPHRAGM PUMP
- 15 FEET OF RUBBER HOSE TO SPRAY GUN
- 2 QUICK ATTACH DEFLECTOR NOZZLES
- ALL-STEEL ATV AND BOOM MOUNTING KIT
- INCLUDES 12 VOLT WIRE HARNESS WITH CLAMPS

## PERFORMANCE

- UP TO 15' VERTICAL AND 25' HORIZONTAL SPOT SPRAY
- UP TO 2 ACRE COVERAGE WITH 7' SPRAY SWATH
- ON-DEMAND PUMP GENERATES 40 PSI

\* GRASS GUARDIAN SPRAYERS COME WITH A 1-YEAR LIMITED WARRANTY ON MANUFACTURING DEFECTS IN PUMP & COMPONENTS.

# TRAILER SPRAYERS 15/25 GALLON

**GRASS**  **GUARDIAN**







# FEATURED SPRAYER



ETI-11-025A-GG

## FEATURES

- ADJUSTABLE SPRAY GUN
- INLINE BOOM SHUT-OFF VALVE
- 1.1 GPM EVERFLO 12 VOLT DIAPHRAGM PUMP
- 15 FEET OF RUBBER HOSE TO SPRAY GUN
- 2 QUICK ATTACH DEFLECTOR NOZZLES
- ALL-STEEL INTEGRATED TRAILER FRAME
- 10" HEAVY-DUTY PNEUMATIC TIRES
- INCLUDES 12 VOLT WIRE HARNESS WITH CLAMPS

## PERFORMANCE

- UP TO 15' VERTICAL AND 25' HORIZONTAL SPOT SPRAY
- UP TO 2 ACRE COVERAGE WITH 7' SPRAY SWATH
- ON-DEMAND PUMP GENERATES 40 PSI

15/25 GALLON	Part #	Pump	Boom	Swath	Capacity	Carton Size	Weight	UPC	Pallet Qty	UPS Ship	Freight Class
	ETI-11-015A-GG	Everflo 1.1 GPM	Dual Deflector Nozzles	7'	15 Gal	42" x 18" x 15"	50 lbs	810044042597	12	Yes	150
	ETI-11-025A-GG	Everflo 1.1 GPM	Dual Deflector Nozzles	7'	25 Gal	42" x 19" x 15"	55 lbs	810044042603	10	Yes	150

# UTV SPRAYER 40 GALLON

GRASS  GUARDIAN





# FEATURED SPRAYER



EUO-F1-040A-GG

## FEATURES

- ADJUSTABLE SPRAY GUN
- PRESSURE REGULATOR & BOOM SHUT-OFF VALVE
- HORIZONTALLY FOLDING ALL-STEEL BOOM
- 3 QUICK ATTACH DEFLECTOR NOZZLES
- ALL-STEEL, OVER-GATE BOOM MOUNTING ARMS
- 2.2 GPM EVERFLO 12 VOLT DIAPHRAGM PUMP
- 15 FEET OF RUBBER HOSE TO SPRAY GUN
- INCLUDES 12 VOLT WIRE HARNESS WITH SWITCH

## PERFORMANCE

- UP TO 25' VERTICAL AND 30' HORIZONTAL SPOT SPRAY
- UP TO 3 ACRE COVERAGE WITH 10' SPRAY SWATH
- ON-DEMAND PUMP GENERATES 70 PSI

40 GALLON	Part #	Pump	Boom	Swath	Capacity	Carton Size	Weight	UPC	Pallet Qty	UPS Ship	Freight Class
		EUO-F1-040A-GG	Everflo 2.2 GPM	Folding, 3 Deflector Nozzles	10'	40 Gal	37" x 24.5" x 21"	43 lbs	810044042634	6	No

# LITHIUM-ION BATTERY CONVERSION 1.0 GPM

**REVOLT** LITHIUM-ION  
BATTERY POWERED

**14**  
VOLT

Part #	Carton Size	Weight	UPC	Master Carton Qty	Pallet Qty	UPS Shippable	Freight Class
REVOLT-144-1	8" x 7.75" x 4"	2.5 lbs	816403009744	4	N/A	Yes	150



# FEATURED PRODUCT



REVOLT-144-1

## FEATURES

- NO WIRES OR VEHICLE BATTERY NEEDED
- CONVERSION KIT FOR 1.0 GPM SPOT SPRAYERS
- 14.4 VOLT BATTERY PACK INCLUDED
- STEEL POWDER COATED WEATHER SHIELD
- TOP-MOUNTED, LIGHTED ON/OFF SWITCH
- BATTERY CHARGER INCLUDED

## PERFORMANCE

- UP TO 30 GALLONS ON SINGLE CHARGE
- APPROXIMATE 2 HR CHARGE TIME

**15**  
GALLON

Part #	Pump	Spray Gun	Carton Size	Weight	UPC	Pallet Qty	UPS Shippable	Freight Class
SSN-01-015A-RM*	1.0 GPM Everflo	Adjustable	34" x 17" x 15"	15 lbs	810044040920	18	Yes	150

\*Spot Sprayer with Rechargeable Revolt Lithium-Ion Battery Conversion Kit

# BACKPACK SPRAYERS 4 GALLON

**REVOLT** LITHIUM-ION  
BATTERY POWERED



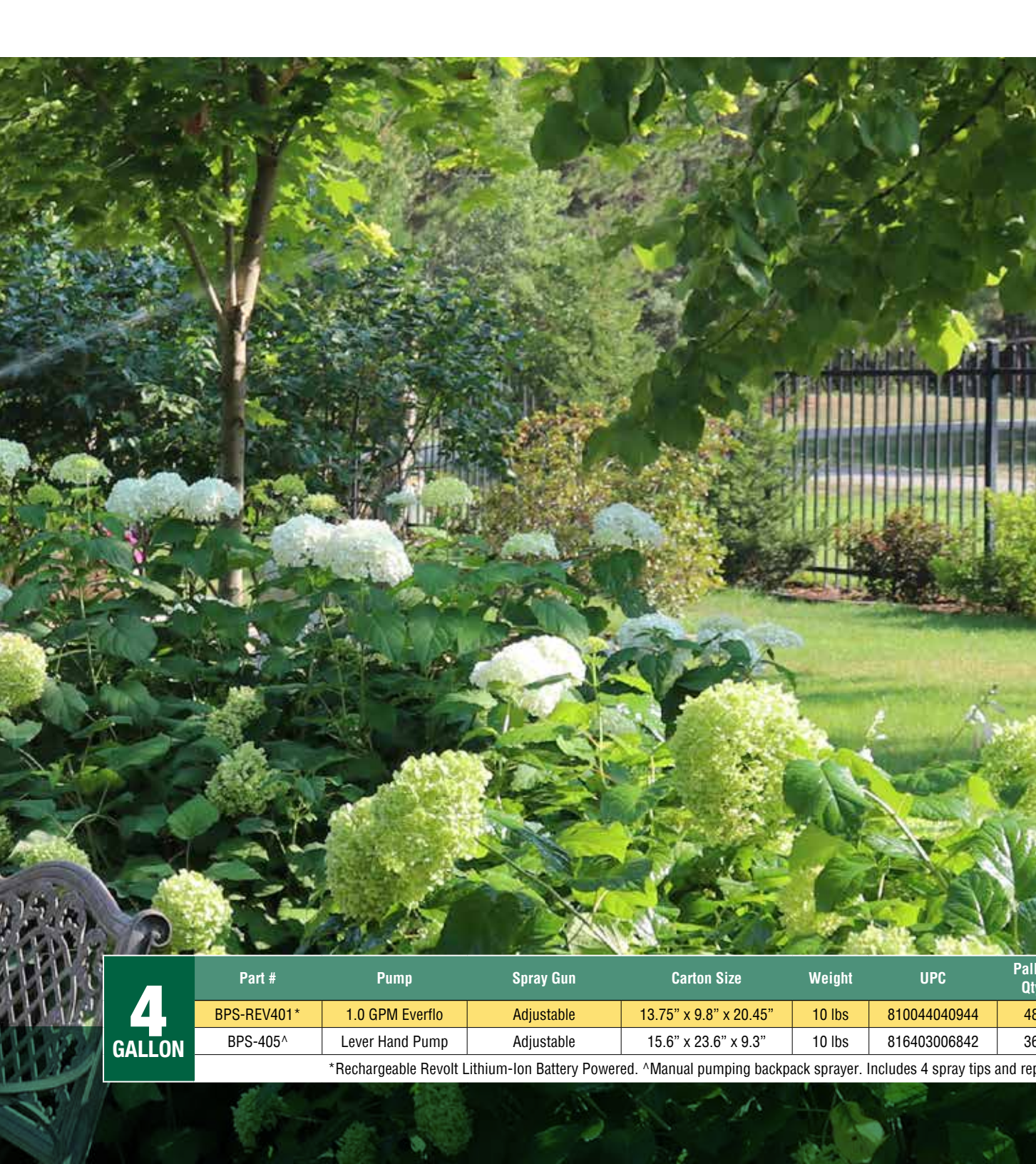

# FEATURED SPRAYER



**BPS-REV401**

## FEATURES

- ADJUSTABLE SPRAY GUN
- 14.4 VOLT BATTERY PACK INCLUDED
- 1.0 GPM EVERFLO 12 VOLT DIAPHRAGM PUMP
- 5 FEET OF NYLON HOSE TO SPRAY GUN
- LIGHTED POWER INDICATOR
- ENCLOSED BATTERY COMPARTMENT
- BATTERY CHARGER INCLUDED
- ADJUSTABLE SHOULDER STRAPS

## PERFORMANCE

- UP TO 30 GALLONS ON SINGLE CHARGE
- UP TO 18' VERTICAL & 20' HORIZONTAL SPOT SPRAY
- ON-DEMAND PUMP GENERATES 40 PSI
- APPROXIMATE 4 HOUR CHARGE TIME

4 GALLON	Part #	Pump	Spray Gun	Carton Size	Weight	UPC	Pallet Qty	UPS Shippable	Freight Class
	BPS-REV401*	1.0 GPM Everflo	Adjustable	13.75" x 9.8" x 20.45"	10 lbs	810044040944	48	Yes	150
BPS-405^	Lever Hand Pump	Adjustable	15.6" x 23.6" x 9.3"	10 lbs	816403006842	36	Yes	150	

\*Rechargeable Revolt Lithium-Ion Battery Powered. ^Manual pumping backpack sprayer. Includes 4 spray tips and repair kit.

# MASTER GARDENER 9 GALLON

**REVOLT** LITHIUM-ION  
BATTERY POWERED







# FEATURED SPRAYER



PCD-E3-009B-MM

## FEATURES

- ADJUSTABLE SPRAY GUN
- HOSE HOOKS ON ADJUSTABLE HANDLE
- 14.4 VOLT BATTERY PACK INCLUDED
- 1.0 GPM EVERFLO 12 VOLT DIAPHRAGM PUMP
- NEVER FLAT POLYMER WHEELS
- 10 FOOT NYLON HOSE TO SPRAY GUN
- LIGHTED POWER INDICATOR
- BATTERY CHARGER INCLUDED

## PERFORMANCE

- UP TO 30 GALLONS ON SINGLE CHARGE
- 50" COVERAGE SWATH WITH REAR NOZZLE
- UP TO 18' VERTICAL & 20' HORIZONTAL SPOT SPRAY
- ON-DEMAND PUMP GENERATES 40 PSI
- APPROXIMATE 4 HOUR CHARGE TIME

9 GALLON	Part #	Swath	Pump	Spray Gun	Carton Size	Weight	UPC	Pallet Qty	UPS Shippable	Freight Class
		PCD-E3-009B-MM	50"	1.0 GPM Everflo	Adjustable	26" x 18" x 21"	40 lbs	814485010481	16	Yes

# HANDHELD SPRAYERS

## 1.2-8.0 LITER



90700012

90700002



1-2 LITER	Part #	Spray Tip	Capacity	Carton Size	Weight	UPC	Master Carton Qty	Pallet Qty	UPS Shippable	Freight Class
	90700012	Adjustable	1.2 Liter (.32 Gallon)	8" x 5" x 11"	1 lbs	816403005531	15	375	Yes	150
90700002	Adjustable	2.0 Liter (.51 Gallon)	7" x 7" x 16"	1.5 lbs	814485019989	15	375	Yes	150	



# FEATURED SPRAYERS



90700065 / 90700008

## FEATURES

- ADJUSTABLE SPRAY GUN
- HAND PUMP BUILT INTO LID
- ERGONOMIC HANDLE W/ TRIGGER LOCK
- ADJUSTABLE SHOULDER STRAPS
- LARGE FILL MOUTH

## PERFORMANCE

LOW VOLUME SPOT SPRAYING

Part #	Spray Gun	Capacity	Carton Size	Weight	UPC	Master Carton Qty	Pallet Qty	UPS Shippable	Freight Class
90700065	Adjustable	6.5 Liter (1.7 Gallon)	7" x 7" x 19"	3 lbs	816403005548	6	90	Yes	150
90700008	Adjustable	8.0 Liter (2.1 Gallon)	7" x 7" x 22"	3 lbs	816403005524	6	90	Yes	150

**6-8  
LITER**

# SPOT SPRAYERS

## 9/11 GALLON

**REVOLT** LITHIUM-ION BATTERY  
OPTION AVAILABLE  
ON SELECT MODELS

9 GALLON	Part #	Pump	Spray Gun	Carton Size	Weight	UPC	Pallet Qty	UPS Shippable	Freight Class
		SSD-01-009B-MM	Everflo 1.0 GPM	Adjustable	19" x 15" x 17"	13 lbs	814485010498	30	Yes



# FEATURED SPRAYER



SSN-06-011Q-MM

## FEATURES

- ADJUSTABLE SPRAY GUN
- HOOK & LOOP HOSE ORGANIZING STRAP
- 1.0 GPM EVERFLO 12 VOLT DIAPHRAGM PUMP
- 10 FEET OF PVC HOSE TO SPRAY GUN
- INCLUDES 12 VOLT WIRE HARNESS WITH CLAMPS
- REAR-FACING DRAIN WITH CAP
- FITS MOST MANUFACTURER'S ATV RACKS

## PERFORMANCE

UP TO 15' VERTICAL AND 20' HORIZONTAL SPOT SPRAY  
ON-DEMAND PUMP GENERATES 40 PSI

	Part #	Pump	Spray Gun	Carton Size	Weight	UPC	Pallet Qty	UPS Shippable	Freight Class
<b>11 GALLON</b>	SSN-06-011Q-MM	Everflo 1.0 GPM	Adjustable	24" x 14.75" x 11.625"	11 lbs	810044042139	44	Yes	150
	SSN-06-011Q-MM-12^	Everflo 1.0 GPM	Adjustable	42.5" x 24" x 48"	112 lbs	50810044040598	48	No	150
	SSN-06-011Q-RM*	Everflo 1.0 GPM	Adjustable	24" x 14.75" x 11.625"	12 lbs	810044042665	44	Yes	150

^12-Pack Quarter Pallet Gaylord Box \*Rechargeable Revolt Lithium-Ion Battery Powered

# SPOT SPRAYERS

## 15/25 GALLON



	Part #	Pump	Spray Gun	Carton Size	Weight	UPC	Pallet Qty	UPS Shippable	Freight Class
<b>15 GALLON</b>	SSN-06-015A-MM-9^	Everflo 1.0 GPM	Adjustable	51" x 40" x 95"	155 lbs	70814485013481	18	No	150
	SSN-01-015A-MM	Everflo 1.0 GPM	Adjustable	34" x 17" x 15"	15 lbs	814485011143	18	Yes	150
	SSO-01-015A-MM	Everflo 2.2 GPM	Adjustable	34" x 17" x 15"	20 lbs	814485010801	18	Yes	150
	SSO-01-015D-MM	Everflo 2.2 GPM	Deluxe Adjustable	34" x 17" x 15"	20 lbs	814485010818	18	Yes	150

^ 9-Pack Pallet Gaylord Box



# FEATURED SPRAYER



SSO-01-025D-MM

## FEATURES

- DELUXE ADJUSTABLE SPRAY GUN
- HOOK & LOOP HOSE ORGANIZING STRAP
- QUICK ATTACH INLINE STRAINER

DELUXE  
FEATURES

- 2.2 GPM EVERFLO 12 VOLT DIAPHRAGM PUMP
- 15 FEET OF RUBBER HOSE TO SPRAY GUN
- INCLUDES 12 VOLT WIRE HARNESS WITH CLAMPS
- FITS MOST MANUFACTURER'S ATV RACKS

## PERFORMANCE

UP TO 25' VERTICAL AND 30' HORIZONTAL SPOT SPRAY  
ON-DEMAND PUMP GENERATES 70 PSI

	Part #	Pump	Spray Gun	Carton Size	Weight	UPC	Pallet Qty	UPS Shippable	Freight Class
<b>25</b> GALLON	SSN-01-025A-MM	Everflo 1.0 GPM	Adjustable	36" x 19" x 19"	25 lbs	814485011655	15	Yes	150
	SSO-01-025A-MM	Everflo 2.2 GPM	Adjustable	36" x 19" x 19"	25 lbs	814485010825	15	Yes	150
	SSO-01-025D-MM	Everflo 2.2 GPM	Deluxe Adjustable	36" x 19" x 19"	25 lbs	814485010832	15	Yes	150

# SPOT SPRAYERS

## 40/60 GALLON



	Part #	Pump	Spray Gun	Carton Size	Weight	UPC	Pallet Qty	UPS Shippable	Freight Class
<b>40 GALLON</b>	SSO-01-040A-MM	Everflo 2.2 GPM	Adjustable	37" x 24.5" x 21"	30 lbs	814485010849	8	Yes	150
	SSO-01-040D-MM	Everflo 2.2 GPM	Deluxe Adjustable	37" x 24.5" x 21"	30 lbs	814485010856	8	Yes	150
	SSP-01-040D-MM*	Everflo 3.0 GPM	Deluxe Adjustable	37" x 24.5" x 21"	30 lbs	810044043792	8	Yes	150

\*Ships Boom-Ready with Variable Pressure Regulator and Boom Shut-Off Valve.



# FEATURED SPRAYER



SSO-01-040D-MM

## FEATURES

- DELUXE ADJUSTABLE SPRAY GUN
- HOOK & LOOP HOSE ORGANIZING STRAP
- QUICK ATTACH INLINE STRAINER
- 2.2 GPM EVERFLO 12 VOLT DIAPHRAGM PUMP
- 15 FEET OF RUBBER HOSE TO SPRAY GUN
- INCLUDES 12 VOLT WIRE HARNESS WITH CLAMPS

DELUXE  
FEATURES

## PERFORMANCE

UP TO 25' VERTICAL AND 30' HORIZONTAL SPOT SPRAY  
ON-DEMAND PUMP GENERATES 70 PSI



60 GALLON	Part #	Pump	Spray Gun	Carton Size	Weight	UPC	Pallet Qty	UPS Shippable	Freight Class
	SSO-01-060A-MM	Everflo 2.2 GPM	Adjustable	37" x 24.5" x 27"	35 lbs	814485010863	8	Yes	150
SSO-01-060D-MM	Everflo 2.2 GPM	Deluxe Adjustable	37" x 24.5" x 27"	35 lbs	814485010870	8	Yes	150	

# ATV SPRAYERS

## 15/25 GALLON



**15**  
GALLON

Part #	Pump	Spray Gun	Spray Boom	Swath	Carton Size	Weight	UPC	Pallet Qty	UPS Shippable	Freight Class
SAO-11-015A-MM	Everflo 2.2 GPM	Adjustable	Dual Deflector Nozzle	7'	42" x 18" x 15"	35 lbs	814485013901	12	Yes	150
SAO-H3-015B-MM	Everflo 2.2 GPM	Adjustable	Single Boomless Nozzle	16'	34" x 17" x 15"	21 lbs	814485013970	18	Yes	150



# FEATURED SPRAYER



SAO-51-025D-MM

## FEATURES

- DELUXE ADJUSTABLE SPRAY GUN
- HOOK & LOOP HOSE ORGANIZING STRAP
- QUICK ATTACH INLINE STRAINER
- ALL-STEEL, HORIZONTALLY FOLDING BOOM
- 6 NO-DRIP, QUICK ATTACH FAN NOZZLES

DELUXE  
FEATURES

- ADJUSTABLE ATV MOUNT AND BRACKETS
- REGULATOR WITH BOOM SHUT-OFF VALVE
- 2.2 GPM EVERFLO 12 VOLT DIAPHRAGM PUMP
- 15 FEET OF RUBBER HOSE TO SPRAY GUN
- 12 VOLT WIRE HARNESS WITH SWITCH
- INCLUDES TWO RATCHET MOUNTING STRAPS

## PERFORMANCE

- UP TO 25' VERTICAL AND 30' HORIZONTAL SPOT SPRAY
- UP TO 2 ACRE COVERAGE WITH 10' SPRAY SWATH
- ON-DEMAND PUMP GENERATES 70 PSI

25 GALLON	Part #	Pump	Spray Gun	Spray Boom	Swath	Carton Size	Weight	UPC	Pallet Qty	UPS Shippable	Freight Class
	SAO-11-025A-MM	Everflo 2.2 GPM	Adjustable	Dual Deflector Nozzles	7'	36" x 19" x 19"	50 lbs	814485013932	10	Yes	150
	SAO-51-025A-MM	Everflo 2.2 GPM	Adjustable	Folding, 6 Flat Fan Nozzles	10'	45" x 18.75" x 15.50	50 lbs	816403009942	10	Yes	150
	SAO-51-025D-MM	Everflo 2.2 GPM	Deluxe Adjustable	Folding, 6 Flat Fan Nozzles	10'	45" x 18.75" x 15.50	50 lbs	816403009942	10	Yes	150
	SAO-H3-025B-MM	Everflo 2.2 GPM	Adjustable	Single Boomless Nozzle	16'	36" x 19" x 19"	35 lbs	814485015691	15	Yes	150
	SAP-G1-025D-MM	Everflo 3.0 GPM	Deluxe Adjustable	Dual Boomless + Deflector	30'	36" x 19" x 19"	35 lbs	814485019996	15	Yes	150
SAP-Y1-025D-MM	Everflo 3.0 GPM	Deluxe Adjustable	2 in 1 Precision & Broadcast	30'	45" x 18.75" x 18"	40 lbs	810044041644	10	Yes	150	

# TRAILER SPRAYERS 12 GALLON

**REVOLT** LITHIUM-ION BATTERY  
OPTION AVAILABLE

**12**  
GALLON

Part #	Pump	Spray Gun	Swath	Carton Size	Weight	UPC	Pallet Qty	UPS Shippable	Freight Class
SL6-46-012Q-MM	1.1 GPM Everflo	Adjustable	84"	24" x 20" x 15"	32 lbs	810044040517	24	Yes	150
SL6-46-012Q-RM*	1.1 GPM Everflo	Adjustable	84"	24" x 20" x 15"	32 lbs	810044040937	24	Yes	150

\*Rechargeable Revolt Lithium-Ion Battery Powered



# FEATURED SPRAYER



SL6-46-012Q-MM

## FEATURES

- ADJUSTABLE SPRAY GUN
- 1.1 GPM EVERFLO 12 VOLT DIAPHRAGM PUMP
- 15 FEET OF PVC HOSE TO SPRAY GUN
- HOOK & LOOP HOSE ORGANIZING STRAP
- ALL-STEEL, POWDER COATED FRAME
- FOLDING TONGUE FOR COMPACT STORAGE
- TONGUE HOOK FOR EASY WALL HANGING
- SINGLE REAR FACING DEFLECTOR NOZZLE
- FOAM FILLED, NEVER FLAT TIRES
- 12 VOLT WIRE HARNESS WITH SWITCH

## PERFORMANCE

- UP TO 15' VERTICAL AND 20' HORIZONTAL SPOT SPRAY
- UP TO 25K SQFT COVERAGE WITH 84" SPRAY SWATH
- ON-DEMAND PUMP GENERATES 40 PSI

# TRAILER SPRAYERS 24/36 GALLON



24 GALLON	Part #	Pump	Spray Gun	Spray Boom	Swath	Carton Size	Weight	UPC	Pallet Qty	UPS Shippable	Freight Class
	SLO-41-024D-MM	2.2 GPM Everflo	Deluxe Adjustable	Folding, 4 Flat Fan Nozzles	7'	48" x 20" x 15"	58 lbs	810044041835	12	No	150



# FEATURED SPRAYER



SLP-51-036D-MM

## FEATURES

- DELUXE ADJUSTABLE SPRAY GUN
- HOOK & LOOP HOSE ORGANIZING STRAP
- QUICK ATTACH INLINE STRAINER
- ALL-STEEL, HORIZONTALLY FOLDING BOOM
- 6 NO-DRIP, QUICK ATTACH FAN NOZZLES
- 3.0 GPM EVERFLO 12 VOLT DIAPHRAGM PUMP
- 16" HEAVY-DUTY PNEUMATIC TIRES

DELUXE  
FEATURES

- REGULATOR WITH BOOM SHUT-OFF VALVE
- ALL-STEEL FRAME & RETRACTABLE TONGUE
- 15 FEET OF RUBBER HOSE TO SPRAY GUN
- 12 VOLT WIRE HARNESS WITH SWITCH

## PERFORMANCE

- UP TO 25' VERTICAL AND 30' HORIZONTAL SPOT SPRAY
- UP TO 3 ACRE COVERAGE WITH 10' SPRAY SWATH
- ON-DEMAND PUMP GENERATES 60 PSI

36 GALLON	Part #	Pump	Spray Gun	Spray Boom	Swath	Carton Size	Weight	UPC	Pallet Qty	UPS Shippable	Freight Class
		SLP-51-036D-MM	3.0 GPM Everflo	Deluxe Adjustable	Folding, 6 Flat Fan Nozzles	10'	48" x 20" x 24"	85 lbs	810044041842	6	No

# TRAILER SPRAYERS 60 GALLON



	Part #	Pump	Spray Gun	Spray Boom	Swath	Carton Size	Weight	UPC	UPS Ship	Freight Class
<b>60 GALLON</b>	SLO-F1-060D-MM	2.2 GPM Everflo	Deluxe Adjustable	Folding, 3 Deflector Nozzles	10'	41.25" x 25.25" x 32.75"	115 lbs	810044043754	No	150
	SLP-Y1-060D-MM	3.0 GPM Everflo	Deluxe Adjustable	2 in 1 Precision & Broadcast	30'	41.25" x 25.25" x 32.75"	130 lbs	810044043761	No	150





# FEATURED SPRAYER



SLP-Y1-060D-MM

## FEATURES

- DELUXE ADJUSTABLE SPRAY GUN
- HOOK & LOOP HOSE ORGANIZING STRAP
- QUICK ATTACH INLINE STRAINER
- ALL-STEEL, PRECISION & BROADCAST BOOM
- 3 FLAT FAN NOZZLES OR 2 BOOMLESS NOZZLES
- 3.0 GPM EVERFLO 12 VOLT DIAPHRAGM PUMP
- 16" HEAVY-DUTY PNEUMATIC TIRES
- REGULATOR WITH BOOM SHUT-OFF VALVE
- ALL-STEEL FRAME & RETRACTABLE TONGUE
- 15 FEET OF RUBBER HOSE TO SPRAY GUN
- 12 VOLT WIRE HARNESS WITH SWITCH

DELUXE  
FEATURES

## PERFORMANCE

- UP TO 25' VERTICAL AND 30' HORIZONTAL SPOT SPRAY
- UP TO 4 ACRE COVERAGE WITH 30' SPRAY SWATH
- ON-DEMAND PUMP GENERATES 60 PSI

# TRAILER SPRAYERS

## 200/300 GALLON



	Part #	Pump	Spray Gun	Spray Boom	Swath	Carton Size	Weight	UPC	UPS Shippable	Freight Class
<b>200 GALLON</b>	SLR-N8-200P-MM	Everflo 5.5 GPM	Adjustable Flash Spray Gun	Folding Chain Boom, 14 Flat Fan Nozzles	23'	60" x 81" x 55"	485 lbs	810044040999	No	150
	SLR-K8-200P-MM	Everflo 5.5 GPM	Adjustable Flash Spray Gun	Single Boomless Nozzle	52'	60" x 81" x 55"	455 lbs	810044040982	No	150



# FEATURED SPRAYER



SLR-N8-200P-MM

## FEATURES

- ADJUSTABLE FLASH SPRAY GUN
- 5.5 GPM EVERFLO DIAPHRAGM PUMP
- ALL-STEEL HEAVY DUTY TRAILER
- RUGGED FOLDING CHAIN BOOM
- 14 QUICK ATTACH, NO-DRIP, FLAT FAN NOZZLES
- 20.5" HEAVY DUTY TIRES
- PRESSURE REGULATING SYSTEM
- INDEPENDENT SUSPENSION AXLE
- TOP WIND TRAILER JACK (2000 LB)
- CONVERTS TO FORKLIFTABLE SKID
- 12" VENTED SCREW ON FILL LID
- LTL SHIPPABLE

## PERFORMANCE

- UP TO 25' VERTICAL AND 30' HORIZONTAL SPOT SPRAY
- UP TO 15 ACRE COVERAGE WITH 23' SPRAY SWATH
- ON-DEMAND PUMP GENERATES 60 PSI

300 GALLON	Part #	Pump	Spray Gun	Spray Boom	Swath	Dimensions	Weight	UPC	UPS Shippable	Freight Class
	SLM-K8-300C-MM	8 Roller Delavan	Adjustable Aluminum	Single Boomless Nozzle	58'	82" x 161" x 55"	940 lbs	810044043921	No	150
SLM-J8-300C-MM	8 Roller Delavan	Adjustable Aluminum	Folding, 21 Flat Fan Nozzles	35'	60" x 81" x 55"	1100 lbs	810044043914	No	150	

# SKID SPRAYERS 60 GALLON



**60  
GALLON**

Part #	Motor	Pump	Hose	Carton Size	Sump	Weight	UPC	UPS Ship	Freight Class
UN5-P7-060F-MM	Rato 7HP 210cc Engine	Delavan 4 Roller	150' 300 PSI	48" x 40" x 31.75"	Yes	185 lbs	810044043785	No	150
UNT-05-060J-MM	Rato 7HP 210cc Engine	Comet APS 41	25' 600 PSI	48" x 40" x 34"	Yes	175 lbs	810044043778	No	150



# FEATURED SPRAYER



UNT-05-060J-MM

## FEATURES

- ADJUSTABLE FLASH SPRAY GUN
- 7.0HP (210CC) RATO GAS ENGINE
- 10 GPM COMET APS 41 DIAPHRAGM PUMP
- REAR-FACING CONTROLS W/PRESSURE RELIEF SYSTEM
- 25 FEET OF 1/2" HIGH PRESSURE HOSE
- QUICK GRIP FRONT & BACK TEAM LIFT HANDLES
- ALL-STEEL, POWDER COATED FORKLIFTABLE FRAME
- STEEL HOSE RACK

## PERFORMANCE

- UP TO 25' VERTICAL AND 30' HORIZONTAL SPRAY
- DIAPHRAGM PUMP GENERATES UP TO 580 PSI

# SKID SPRAYERS

150-200  
GALLON



	Part #	Motor	Pump	Carton Size	Weight	UPC	UPS Shippable	Freight Class
<b>150 GALLON</b>	SUL-01-150C-MM	3.5 HP Briggs & Stratton	6 Roller Delavan	42" x 72" x 55"	285 lbs	816403006330	No	150
	SUR-K8-150P-MM	None	Everflo 5.5 GPM	42" x 72" x 55"	285 lbs	810044041040	No	150



# FEATURED SPRAYER



SUL-01-150C-MM

## FEATURES

- 22" ALUMINUM JET STREAM ADJUSTABLE SPRAY GUN
- 3.5HP (280CC) BRIGGS AND STRATTON GAS ENGINE
- 19 GPM DELAVAN CAST IRON 6 ROLLER PUMP
- REAR-FACING CONTROL BAY W/PRESSURE RELIEF SYSTEM
- ALL-STEEL, POWDER COATED FORKLIFTABLE FRAME
- 15 FEET OF 1/2" RUBBER HOSE TO SPRAY GUN
- 12" VENTED SCREW ON FILL LID

## PERFORMANCE

- UP TO 25' VERTICAL AND 30' HORIZONTAL SPOT SPRAY
- ROLLER PUMP GENERATES 300 PSI

200 GALLON	Part #	Motor	Pump	Carton Size	Weight	UPC	UPS Shippable	Freight Class
	SUL-01-200C-MM	3.5 HP Briggs & Stratton	6 Roller Delavan	42" x 72" x 55"	395 lbs	816403006347	No	150
	SUR-K8-200P-MM	None	Everflo 5.5 GPM	42" x 72" x 55"	375 lbs	810044041057	No	150
	FUS-Z1-200K-MM	3.5 HP Briggs & Stratton	8 Roller Delavan	42" x 72" x 55"	395 lbs	814485010146	No	150

# UTV SPRAYERS 50 GALLON

CHANGE FROM PRECISION FAN NOZZLES TO BOOMLESS BROADCAST SPRAYING WITH A SIMPLE TWIST OF THE NOZZLE ASSEMBLIES

PRECISION  
(Fan Tips)

OFF

BROADCAST  
(Boomless Nozzles)

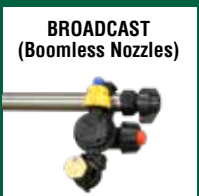
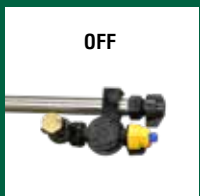

**50**  
GALLON

Part #	Pump	Spray Gun	Spray Boom	Spray Swath	Carton Size	Weight	UPC	Pallet Qty	UPS Shippable	Freight Class
UNP-51-050D-MM	Everflo 3.0 GPM	Deluxe Adjustable	Folding, 6 Flat Fan Nozzles	10'	46" x 38" x 19"	95 lbs	816403009911	5	No	150
UNP-Y1-050D-MM	Everflo 3.0 GPM	Deluxe Adjustable	2 in 1 Precision & Broadcast Boom	30'	46" x 38" x 19"	83 lbs	816403009553	5	No	150





# FEATURED SPRAYER



UNP-Y1-050D-MM

## FEATURES

- DELUXE ADJUSTABLE SPRAY GUN
- 3.0 GPM EVERFLO DIAPHRAGM PUMP
- BOOMLESS AND PRECISION SPRAYING MODES
- OVER-GATE SPRAY BOOM MOUNTING SYSTEM

DELUXE  
FEATURES

- RECESSED DRIVER-SIDE CONTROL BAY
- REGULATOR WITH BOOM SHUT-OFF VALVE
- ALL-STEEL, ON TANK HANDLES FOR EASY LIFTING
- 15 FEET OF RUBBER HOSE TO SPRAY GUN
- ANGLED BASE FOR COMPLETE DRAINAGE
- 8" VENTED SCREW ON FILL LID

## PERFORMANCE

- UP TO 25' VERTICAL AND 30' HORIZONTAL SPOT SPRAY
- UP TO 4 ACRE COVERAGE MULTIPLE SPRAY SWATHS
- ON-DEMAND PUMP GENERATES 60 PSI

# 3-POINT SPRAYERS

## 40/60 GALLON



**40**  
GALLON

Part #	Pump	Spray Gun	Spray Boom	Swath	Carton Size	Weight	UPC	Pallet Qty	UPS Shippable	Freight Class
S30-51-040A-MM	Everflo 2.2 GPM	Adjustable	Folding, 6 Flat Fan Nozzles	10'	40" x 33" x 34"	86 lbs	816403009928	4	No	150
S30-51-040D-MM	Everflo 2.2 GPM	Deluxe Adjustable	Folding, 6 Flat Fan Nozzles	10'	40" x 33" x 34"	86 lbs	816403009720	4	No	150



# FEATURED SPRAYER



S30-61-060D-MM

## FEATURES

- DELUXE ADJUSTABLE SPRAY GUN
- HOOK & LOOP HOSE ORGANIZING STRAP
- QUICK ATTACH INLINE STRAINER
- ALL-STEEL, HORIZONTALLY FOLDING BOOM
- 8 NO-DRIP, QUICK ATTACH FAN NOZZLES
- REGULATOR WITH BOOM SHUT-OFF VALVE
- 2.2 GPM EVERFLO 12 VOLT DIAPHRAGM PUMP
- 15 FEET OF RUBBER HOSE TO SPRAY GUN
- 12 VOLT WIRE HARNESS WITH SWITCH

DELUXE  
FEATURES

## PERFORMANCE

- UP TO 25' VERTICAL AND 30' HORIZONTAL SPOT SPRAY
- UP TO 5 ACRE COVERAGE WITH 13' SPRAY SWATH
- ON-DEMAND PUMP GENERATES 70 PSI

60 GALLON	Part #	Pump	Spray Gun	Spray Boom	Swath	Carton Size	Weight	UPC	Pallet Qty	UPS Shippable	Freight Class
	S3A-24-060N-MM	None	No Spray Gun	Folding, 3 Deflector Nozzles	10'	40" x 33" x 34"	90 lbs	816403004831	4	No	150
	S30-51-060D-MM	Everflo 2.2 GPM	Deluxe Adjustable	Folding, 6 Flat Fan Nozzles	10'	40" x 33" x 34"	112 lbs	810044041231	4	No	150
	S30-61-060D-MM	Everflo 2.2 GPM	Deluxe Adjustable	Folding, 8 Flat Fan Nozzles	13'	40" x 33" x 34"	118 lbs	816403009935	4	No	150

# 3-POINT SPRAYERS

150-300  
GALLON



**150**  
GALLON

Part #	Pump	Spray Gun	Spray Boom	Swath	Carton Size	Weight	UPC	UPS Shippable	Freight Class
S3K-N1-150P-MM	6 Roller Delavan	Adjustable Flash Gun	Folding Chain Boom, 14 Flat Fan Nozzles	23'	48" x 96" x 46"	430 lbs	810044041002	No	150
S3K-K1-150P-MM	6 Roller Delavan	Adjustable Flash Gun	Single Boomless Nozzle	52'	48" x 96" x 46"	380 lbs	810044041026	No	150



# FEATURED SPRAYER



S3K-N1-200P-MM

## FEATURES

- ADJUSTABLE MISTING SPRAY GUN
- 19 GPM DELAVAN CAST IRON 6 ROLLER PUMP
- THREE SECTION, FOLDABLE CHAIN BOOM
- INDIVIDUAL BOOM SECTION CONTROL
- 14 QUICK ATTACH, NO-DRIP FAN NOZZLES
- EASY TO REACH PRESSURE RELIEF SYSTEM
- ALL-STEEL, POWDER COATED FRAME
- 12" VENTED SCREW ON FILL LID

## PERFORMANCE

- UP TO 25' VERTICAL AND 30' HORIZONTAL SPOT SPRAY
- UP TO 20 ACRE COVERAGE WITH 23' SPRAY SWATH
- ROLLER PUMP GENERATES 300 PSI

200 /300 GALLON	Part #	Pump	Spray Gun	Spray Boom	Swath	Carton Size	Weight	UPC	UPS Shippable	Freight Class
	S3K-N1-200P-MM	6 Roller Delavan	Adjustable Flash Gun	Folding Chain Boom, 14 Flat Fan Nozzles	23'	48" x 96" x 46"	430 lbs	810044041019	No	150
	S3K-K1-200P-MM	6 Roller Delavan	Adjustable Flash Gun	Single Boomless Nozzle	58'	48" x 96" x 46"	380 lbs	810044041033	No	150
	S3M-J8-300C-MM	8 Roller Delavan	Adjustable Aluminum	Folding, 21 Flat Fan Nozzles	35'	58" x 80" x 97"	700 lbs	810044043938	No	150
	S3M-K8-300C-MM	8 Roller Delavan	Adjustable Aluminum	Single Boomless Nozzle	58'	58" x 80" x 76"	550 lbs	810044043945	No	150

# HIGH PRESSURE SPRAYERS

## 25 GALLON



**Sprayer**  
**SK4-01-000P-MM**



**ANY VOLUME**

Part #	Pump	Spray Gun	Carton Size	Weight	UPC	Pallet Qty	UPS Shippable	Freight Class
SK4-01-000P-MM	HP 2.0 GPM Everflo	Adjustable Flash Spray Gun	14.75" x 12.75" x 12.5"	23 lbs	814485012065	27	Yes	150

Carry-Around Sprayer with Inlet, Spray Gun and Carry Handle. Pump from Any Source or Tank Size.

# FEATURED SPRAYER



SS4-01-025P-MM

## FEATURES

- ADJUSTABLE FLASH SPRAY GUN
- 2.0 GPM EVERFLO HIGH PRESSURE PLUNGER PUMP
- HOOK & LOOP HOSE ORGANIZING STRAP
- PRESSURE REGULATING SYSTEM
- 25 FEET OF 1/2" RUBBER HOSE

## PERFORMANCE

- 35' HORIZONTAL & 30' VERTICAL SPOT SPRAY
- ON-DEMAND PUMP GENERATES 200 PSI

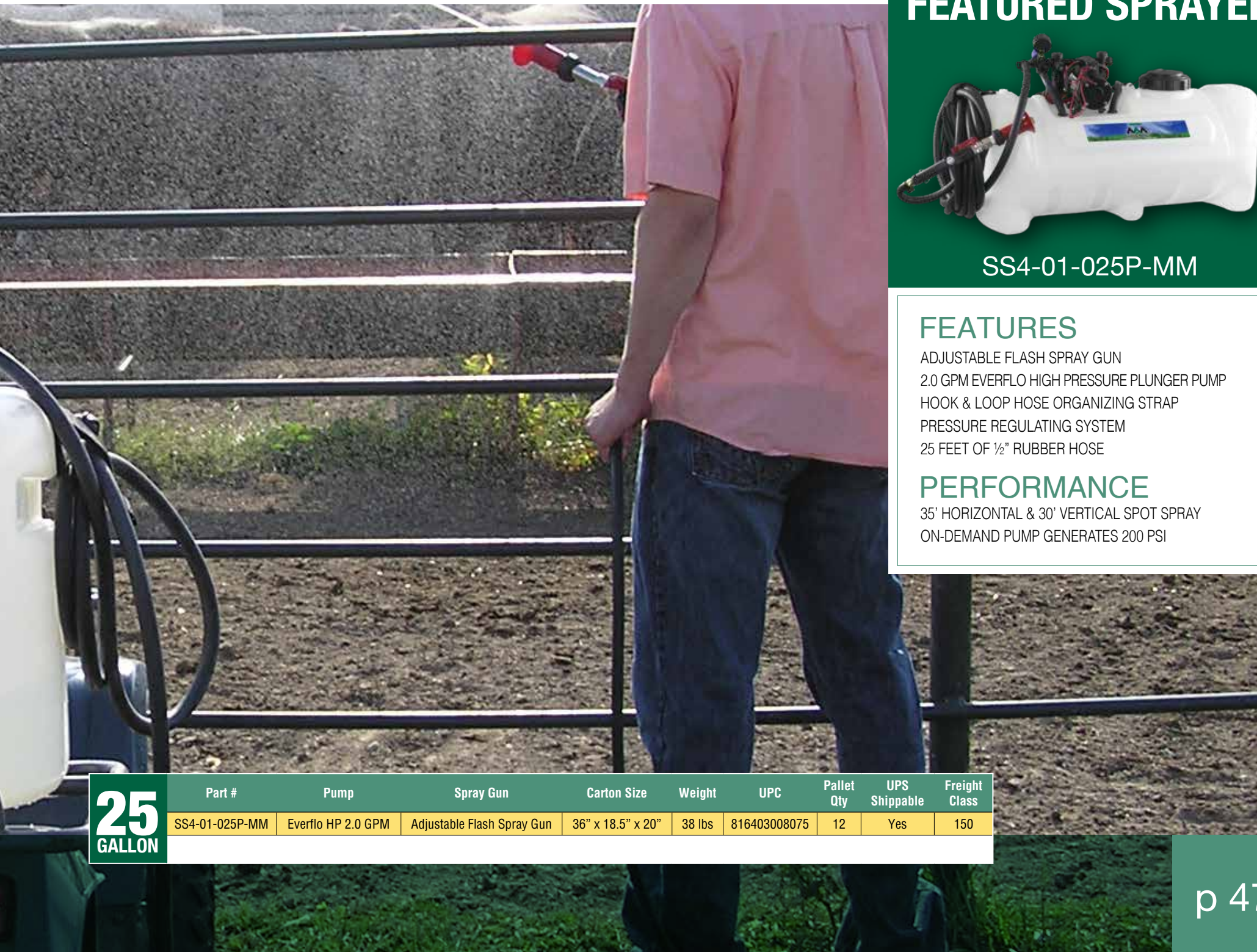

**25**  
GALLON

Part #	Pump	Spray Gun	Carton Size	Weight	UPC	Pallet Qty	UPS Shippable	Freight Class
SS4-01-025P-MM	Everflo HP 2.0 GPM	Adjustable Flash Spray Gun	36" x 18.5" x 20"	38 lbs	816403008075	12	Yes	150

# MIST BLOWER PORTABLE







# FEATURED SPRAYER



**MMW-01-000N-MM**

## FEATURES

- 7.0HP (210CC) RATO GAS ENGINE
- 210-DEGREE MANUALLY ROTATING FAN
- VOLUTE WITH 2 FAN NOZZLES
- CENTRALIZED HANDLES FOR EASY TEAM LIFTS
- ALL-STEEL, HEAVY-DUTY FRAME

## PERFORMANCE

- MIST UP TO 75' HORIZONTAL & 40' VERTICAL
- MINIMUM OF 2.2 GPM REQUIRED TO MIST

ANY VOLUME	Part #	Engine	Pump	Mist Volute	Carton Size	Weight	UPC	Pallet Qty	UPS Shippable	Freight Class
	MMW-01-000N-MM	Rato 7HP 210cc	None	Flat Fan Nozzles	34" x 10.5" x 28"	78 lbs	810044043211	6	No	150

**Mist Sprayer Attaches to Existing Spot Sprayer (sold separately)**



# UNIQUE SPECIALTY DESIGNS

	Part #	Pump	Capacity	Carton Size	Weight	UPC	Pallet Qty	UPS Ship	Freight Class
<b>15-40 GALLON</b>	SSX-02-015A-B-MM	Flojet 1.6 GPM	15 Gal	35" x 17" x 15"	16 lbs	814485012331	18	Yes	150
	SSX-02-025A-B-MM	Flojet 1.6 GPM	25 Gal	36" x 19" x 19"	23 lbs	814485012515	15	Yes	150
	SSX-02-040A-B-MM	Flojet 1.6 GPM	40 Gal	37" x 25" x 21"	26 lbs	814485012331	8	Yes	150

## FEATURES

- ADJUSTABLE SPRAY GUN
- 1.6 FLOJET 12V DIAPHRAGM PUMP
- 15' BRAIDED NYLON HOSE TO SPRAY GUN
- INCLUDES 12V WIRE HARNESS WITH CLAMPS

## PERFORMANCE

- DIESEL MIX COMPATIBLE
- 16' VERTICAL & 25' HORIZONTAL SPOT SPRAY
- ON-DEMAND PUMP GENERATES 60 PSI

## BRUSHPRO™

SSX-02-015A-B





# UNIQUE SPECIALTY DESIGNS

25 GALLON	Part #	Pump	Capacity	Carton Size	Weight	UPC	Pallet Qty	UPS Ship	Freight Class
	SSP-L1-025N-MM	3.0 GPM Everflo	25 Gal	36" x 19" x 19"	25 lbs	814485016285	15	Yes	150
Hay Sprayer Includes Hoses, Fittings & Nozzles to Attach to Hay Baler									



## HAY SPRAYER

SSP-L1-025N-MM

- ### FEATURES
- 3.0 GPM EVERFLO PUMP
  - VARIABLE PRESSURE REGULATOR
  - POPPET BOOM SHUT-OFF VALVE
  - 4 CONICAL NOZZLES & PLUMBING FITTINGS TO ATTACH TO HAY BALER
  - IDEAL FOR MOLD INHIBITORS
  - 12V CONNECTION CABLES

# PROFESSIONAL SPRAYERS 35-110 GALLON



**Sprayer**  
**PP2-Q7-035M-MM**



<b>35 GALLON</b>	Part #	Hose Reel	Pump	Spray Gun	Carton Size	Weight	UPC	UPS Ship	Freight Class
	PP2-Q7-035M-MM	12" Aluminum U-Channel	Dual Everflo 2.2 GPM	Adjustable Jet	48" x 40" x 32"	205 lbs	814485016575	No	150

# FEATURED SPRAYER



PAV-Q7-050M-MM

## FEATURES

- ADJUSTABLE LAWN CARE SPRAY GUN
- 6.5HP (196CC) HONDA GAS ENGINE
- 10 GPM COMET APS 41 DIAPHRAGM PUMP
- REAR-FACING CONTROLS W/PRESSURE RELIEF SYSTEM
- 12" HEAVY-DUTY ALUMINUM MANUAL HOSE REEL
- 200 FEET OF 1/2" HIGH PRESSURE HOSE
- CORROSION RESISTANT ALUMINUM FORKLIFTABLE FRAME
- COMPACT DESIGN THAT FITS UNDER TRUCK BED COVERS

## PERFORMANCE

- UP TO 35' VERTICAL AND 45' HORIZONTAL SPRAY
- DIAPHRAGM PUMP GENERATES UP TO 580 PSI



**50/  
110  
GALLON**

Part #	Hose Reel	Pump	Spray Gun	Capacity	Carton Size	Weight	UPC	UPS Ship	Freight Class
PAV-Q7-050M-MM	12" Aluminum Manual	Comet APS 41	Adjustable Jet	50 Gal	72" x 60" x 48"	310 lbs	814485016582	No	150
PAV-S7-110M-MM	12" Aluminum Manual	Comet APS 41	Adjustable Jet	110 Gal	70" x 58" x 50"	395 lbs	814485016599	No	150

# BOOM MOUNTING SYSTEM FOR 2" RECEIVERS



<b>RECEIVER MOUNT</b>	Part #	Carton Size	Weight	UPC	Pallet Qty	UPS Ship	Freight Class
	SSFK-UTVBR*	30" x 8.5" x 3.75"	19 lbs	810044043402	50	Yes	150
*Patent Pending							



# FEATURED PRODUCT

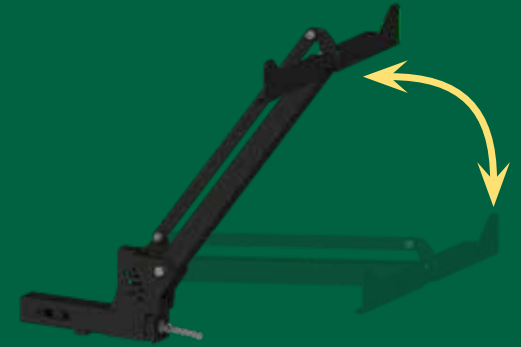

SSFK-UTVBR

## FEATURES

- 10 ADJUSTABLE, SELF-LEVELING POSITIONS
- RECEIVER NO WOBBLE TENSION LOCKING SYSTEM
- ARM DROP SAFETY CATCH WHEN ADJUSTING
- TOOL-FREE INSTALLATION
- ALL-STEEL, POWDER COATED PARTS

## PERFORMANCE

- FITS INTO ANY 2" RECEIVER
- UNIVERSAL MOUNTING SYSTEM WITH MASTER BOOM KITS
- ADJUSTS TO PERFECT SPRAY HEIGHT

# BOOM KITS

## 7-13' COVERAGE

### FEATURES

- ADJUSTABLE BRACKETS FOR PERFECT SPRAY HEIGHT
- BOTTOM MOUNTED 100 PSI PRESSURE GAUGE
- ADJUSTABLE PRESSURE REGULATOR
- BOOM SHUT-OFF VALVE
- 12 VOLT WIRE HARNESS WITH SWITCH
- ALL-STEEL, POWDER-COATED DESIGN

**SSBK-240**



7' Swath	40" Nozzle Spacing
Dual Deflector Nozzles (DF3.0-CSK)	Min. 1.1 GPM Required
Compact Design	

**SSBK-340**



10' Swath	40" Nozzle Spacing
Three Deflector Nozzles (DF3.0-CSK)	Min. 1.8 GPM Required
Folding Arm Design	

**SSBK-620**



10' Swath	20" Nozzle Spacing
6 No-Drip, Fan Nozzles (9.0808.002-CSK)	Min. 1.8 GPM Required
Folding Arm Design	

**SSBK-820**



13' Swath	20" Nozzle Spacing
8 No-Drip, Fan Nozzles (90.080.001-CSK)	Min. 1.8 GPM Required
Folding Arm Design	

Part #	Carton Size	Weight	UPC	Pallet Qty	UPS Ship	Freight Class
SSBK-240	23" x 3.75" x 8"	8 lbs	810044040678	50	Yes	150
SSBK-340	44.25" x 3.75" x 8"	11 lbs	810044042443	50	Yes	150
SSBK-620	47.5" x 5.75" x 8"	17 lbs	810044040494	25	Yes	150
SSBK-820	60.75" x 5.75" x 8"	23 lbs	810044040500	25	Yes	150



### SSBK-SNB-2

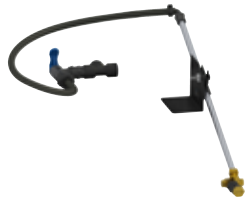

16' Swath	Single Nozzle (BN2BP125FWX-CS)
Min. 2.0 GPM Required	Regulator & Pressure Gauge Not included

### SSBK-NB-2



16' Swath	Single Nozzle (BN2BP125FWX-CS)
Min. 2.0 GPM Required	

### SSBK-DNB-2



8-16' Swath	Dual Nozzle (BN2BP088LSX-CS & BN2BP088RSX-CS)
Min. 2.0 GPM Required	

### SSBK-DNB-3



11-22' Swath	Dual Nozzle (BN2BP116LSX-CS & BN2BP116RSX-CS)
Min. 3.0 GPM Required	

### SSBK-3TDNB



8-30' Swath	Dual Nozzle (BN2BP116LSX-CS & BN2BP116RSX-CS)
Single Deflector Nozzle (DF3.0-CSK)	Min. 3.0 GPM Required

### SSBK-PNB



5-30' Swath	Dual Nozzle (BN2BP088LSX-CS & BN2BP088RSX-CS)
Three Air Induction Nozzles (G-8259494-CSK)	Min. 2.0 GPM Required
Adjustable Inner & Outer Nozzle Bodies	

# BOOMLESS NOZZLE KITS

## 8-30' COVERAGE

### FEATURES

- ADJUSTABLE BRACKETS FOR PERFECT SPRAY HEIGHT
- BOTTOM MOUNTED 100 PSI PRESSURE GAUGE
- ADJUSTABLE PRESSURE REGULATOR
- BOOM SHUT-OFF VALVE
- 12 VOLT WIRE HARNESS WITH SWITCH
- ALL-STEEL, POWDER-COATED DESIGN

Part #	Carton Size	Weight	UPC	Pallet Qty	UPS Ship	Freight Class
SSBK-SNB-2	27.25" x 3.5" x 5.25"	3 lbs	814485015905	75	Yes	150
SSBK-NB-2	31" x 4" x 9"	7 lbs	816403003834	75	Yes	150
SSBK-DNB-2	31" x 4" x 9"	7 lbs	816403003858	75	Yes	150
SSBK-DNB-3	31" x 4" x 9"	7 lbs	816403003865	75	Yes	150
SSBK-3TDNB	31" x 4" x 9"	9 lbs	814485014045	75	Yes	150
SSBK-PNB	45" x 9" x 4"	8 lbs	816403008310	50	Yes	150

\* ALL BROADCAST SPRAY BOOMS COME BOXED AND RETAIL READY LABELED.

# NPT EVERFLO DIAPHRAGM PUMPS & HEADS 1.0-7.0 GPM



EF1000



EF2200



EF3000



EF4000



EF5500



EF7000

## FEATURES

- 100% CONTINUOUS DUTY RATING
- SELF-PRIMING UP TO 12 FEET (W/SPECIFIC MODELS)
- AUTOMATIC TURN-OFF WHEN NO FLOW REQUIRED
- INLINE FUSE PROTECTION
- POLYPROPYLENE HOUSING & VALVE PLATE
- QUALITY VITON® VALVES
- SANTOPRENEM DIAPHRAGMS
- HONEYWELL MICRO SWITCH™
- ZINC PLATED STEEL FASTENERS
- UNIVERSAL MOUNTING PATTERN
- CE APPROVED
- GLYPHOSATE COMPATIBLE

NPT PUMPS	Part #	GPM	Ports	Carton Size	Weight	UPC	Master Carton Qty	Pallet Qty	UPS Ship	Freight Class
	EF1000-BOX	1.0	3/8" HB	8.5" x 4.13" x 2.75"	2 lbs	814485010399	12	540	Yes	150
	EF2200-BOX	2.2	3/8" NPT	9.75" x 4.25" x 4"	6 lbs	814485010405	12	288	Yes	150
	EF3000-BOX	3.0	1/2" NPT	10.25" x 6.25" x 5.25"	7 lbs	814485010412	6	144	Yes	150
	EF4000-BOX	4.0	1/2" NPT	10.25" x 6.25" x 5.25"	7 lbs	814485010429	6	144	Yes	150
	EF5500-BOX	5.5	1/2" NPT	10.25" x 6.25" x 5.25"	7 lbs	814485010436	6	144	Yes	150
	EF7000-BOX	7.0	1/2" NPT	11" x 6.25" x 6"	10 lbs	814485012003	4	108	Yes	150



NPT PUMP HEADS	Part #	GPM	Ports	Carton Size	Weight	UPC	Master Carton Qty	UPS Ship	Freight Class
	EF2200-KIT	2.2	3/8" NPT	4" x 4" x 4"	0.8 lbs	814485013383	16	Yes	150
	EF3000-KIT	3.0	1/2" NPT	5" x 5" x 5"	1.4 lbs	814485013390	12	Yes	150
	EF4000-KIT	4.0	1/2" NPT	5" x 5" x 5"	1.4 lbs	814485013406	12	Yes	150
	EF5500-KIT	5.5	1/2" NPT	5" x 5" x 5"	1.4 lbs	814485013413	12	Yes	150
	EF7000-KIT	7.0	1/2" NPT	5" x 5" x 5"	1.4 lbs	814485015851	12	Yes	150

# QA EVERFLO DIAPHRAGM PUMPS & HEADS 2.0-7.0 GPM



EF2200-QA



EF3000-QA



EF4000-QA



EF5500-QA



EF7000-QA

QA PUMPS	Part #	GPM	Ports	Carton Size	Weight	UPC	Master Carton Qty	Pallet Qty	UPS Ship	Freight Class
	EF2200-QA-BOX	2.2	QA	9.75" x 4.25" x 4"	6 lbs	814485013789	12	288	Yes	150
EF3000-QA-BOX	3.0	QA	10.25" x 6.25" x 5.25"	7 lbs	814485013796	6	144	Yes	150	
EF4000-QA-BOX	4.0	QA	10.25" x 6.25" x 5.25"	7 lbs	814485013802	6	144	Yes	150	
EF5500-QA-BOX	5.5	QA	10.25" x 6.25" x 5.25"	7 lbs	814485013819	6	144	Yes	150	
EF7000-QA-BOX	7.0	QA	11" x 6.25" x 6"	10 lbs	814485015844	4	108	Yes	150	



QA PUMP HEADS	Part #	GPM	Ports	Carton Size	Weight	UPC	Master Carton Qty	UPS Ship	Freight Class
	EF2200-QA-KIT	2.2	QA	4" x 4" x 4"	0.8 lbs	814485018647	16	Yes	150
EF3000-QA-KIT	3.0	QA	5" x 5" x 5"	1.4 lbs	814485018654	12	Yes	150	
EF4000-QA-KIT	4.0	QA	5" x 5" x 5"	1.4 lbs	814485018661	12	Yes	150	
EF5500-QA-KIT	5.5	QA	5" x 5" x 5"	1.4 lbs	814485018678	12	Yes	150	
EF7000-QA-KIT	7.0	QA	5" x 5" x 5"	1.4 lbs	814485018685	12	Yes	150	



EFHP2000

HP PUMP	Part #	GPM	PSI	Ports	Carton Size	Weight	UPC	Master Carton Qty	Pallet Qty	UPS Ship	Freight Class
	EFHP2000-BOX	2.0	200	QA	13.5" x 10" x 8.25"	15 lbs	814485016322	4	84	Yes	150

# BOOM SPRAY NOZZLES

## NOZZLE CHARTS PAGE 73

### 80° Flat Fan Nozzles



Part #	Color	UPC
90.080.002-CSK	Yellow	816403006194
90.080.003-CSK	Blue	816403006200
90.080.004-CSK	Red	816403005999
90.080.006-CSK	Gray	814485012201
90.080.008-CSK	White	814485012225

Medium Drop Size

Medium Drift Hazard

30-60 PSI

20-28" Height Suggested

### 110° Air Induction Nozzles



Part #	Color	UPC
G-8259492-CSK	Yellow	814485018005
G-8259493-CSK	Purple	814485018012
G-8259494-CSK	Blue	814485018029
G-8259495-CSK	Red	814485018036
G-8259496-CSK	Brown	814485018753
G-8259557-CSK	Gray	814485018692

Medium Drop Size

Low Drift Hazard

25-90 PSI

20" Height Suggested

### 140° Deflector Nozzles



Larger Orifice for Clog Resistance

Part #	Color	UPC
DF2.0-CSK	Red	816403006026
DF2.5-CSK	Brown	816403006019
DF3.0-CSK	Gray	816403006002
DF4.0-CSK	White	814485011129
DF5.0-CSK	Blue	814485011112
DF7.5-CSK	Green	814485012249
DF10.0-CSK	Black	814485012256

10-45 PSI

Medium Drop Size

Low Drift Hazard

14-20" Height Suggested

# BOOMLESS SPRAY NOZZLES

## Left, Right & Full Pattern Boomless Nozzles



Part #	Pattern	GPM	Swath	Orifice	UPC
BN2BP088LSX-CS	Left	2	8'	.088	816403003728
BN2BP088RSX-CS	Right	2	8'	.088	816403003735
BN2BP125FWX-CS	Full	2	16'	.125	816403003742
BN2BP116LSX-CS	Left	3	11'	.116	816403003759
BN2BP116RSX-CS	Right	3	11'	.116	816403003766
BN2BP152FWX-CS	Full	3	22'	.152	816403003773

Suggested Pressure: 30-60 PSI

Medium Drift Hazard

Suggested Height: 24-48"

Includes 1/4" x 11/16" Female Adapter

## Half & Full Pattern Boomless Nozzles for High Volume Pumps



Part #	GPM	Swath	Orifice	UPC
6540-01-CSK	2.4	50'	#5	816403007221
6541-01-CSK	5.0	52'	#10	814485013185
6542-01-CSK	7.0	58'	#20	816403008051

Suggested Pressure: 40-60 PSI

Medium Drift Hazard

Suggested Height: 24-48"

Includes 1/2" MNPT x 3/8" FNPT Reducer Bushing



## NOZZLE CHARTS PAGE 74

\* ALL SPRAYER ACCESSORIES ENDING IN "-CSK" COME CLAMSHELLED WITH INFO INSERT CARD. AVAILABLE IN BULK OFFERING AS WELL.

# SPRAYER ACCESSORIES SPRAY GUNS

All Spray Guns Feature an Adjustable Spray Pattern from Fine Mist to Solid Stream.

Trigger Spray Gun	
Part: SG-4200-18	UPC: 816403003476
Part: SG-4200-18-CB	UPC: 816403005968
	
30" Overall Length	Chromed Aluminum Lance
In-Handle Filter	3/8" Hose Barb Inlet
#18 Orifice	

Trigger Spray Gun	
Part: SG-4507F	UPC: 816403001243
Part: SG-4507-CB	UPC: 816403005944
	
30" Overall Length	3/8" Hose Barb Inlet
Chromed Aluminum Lance	In-Handle Filter

Deluxe Pistol Grip Spray Gun	
Part: SG-2218-18	UPC: 816403003445
Part: SG-2218-18-CB	UPC: 816403005975
Part: SG-2218-24	UPC: 816403002189
Part: SG-2218-24-CB	UPC: 814485018166
	
Brass Nozzle	350 PSI Max Pressure
3/8" Hose Barb Inlet	7 GPM Max Flow
Adjustable Spray Nozzle	#18 Orifice
Locking Spray Grip	18" and 24" Lengths

Heavy-Duty Pistol Grip Spray Gun	
Part: SG-5518-09	UPC: 816403005814
Part: SG-5518-09-CB	UPC: 816403005913
Part: SG-5518-18	UPC: 816403002752
Part: SG-5518-18-CB	UPC: 816403005906
Part: SG-5518-24	UPC: 816403005821
	
Brass Nozzle	350 PSI Max Pressure
3/8" Hose Barb Inlet	7 GPM Max Flow
Adjustable Spray Nozzle	#18 Orifice
Locking Spray Grip	9", 18" and 24" Lengths

Telescoping Spray Gun	
Part: SG-500T	UPC: 816403002813
Part: SG-500T-CB	UPC: 816403005920
	
40" Max Length	Chromed Aluminum Lance
In-Handle Filter	3/8" Hose Barb Inlet
#18 Orifice	

### Jet Stream Aluminum Wand Spray Gun

Part: SG-1005      UPC: 814485018234



Control Handle      Up to 400 PSI  
 23" Overall Length      3/4" FGH Inlet

### Jet Stream Aluminum Trigger Spray Gun

Part: SG-1700-13      UPC: 814485018210



Dripless Nozzle      Up to 8 GPM  
 Up to 800 PSI      Ergonomic Handle  
 13" Aluminum Barrel      1/2" FNPT Inlet

### Jet Stream Trigger Spray Gun

Part: SG-1700-22      UPC: 814485018227



Dripless Nozzle      Up to 8 GPM  
 Up to 800 PSI      Ergonomic Handle  
 22" Aluminum Barrel      1/2" FNPT Inlet

### Flash Spray Gun

Part: SG-2200      UPC: 816403003421

Part: SG-2200-CSK      UPC: 810044041415



Thumb Lever Spray Adjust      3/8" Hose Barb Inlet  
 15 GPM Max / 5 GPM Min      400 PSI Max / 100 PSI Min  
 16" Overall Length      Adjusts Mist to Stream  
 Includes Interchangeable Nozzles and Inlet (-CSK only)

### Long Range Spray Gun

Part: SG-3200      UPC: 816403003438



Adjusts Mist to Stream      850 PSI Max / 100 PSI Min  
 1/2" Hose Barb Inlet      25 GPM Max / 5 GPM Min  
 26.5" Overall Length      Ergonomic Handle  
 Locking Grip w/Handguard      3.5 Lbs

### Jet Spray Gun

Part: SG-PC-025      UPC: 814485010542



Durable Teflon Seals      Brass 1/2" FNPT Inlet  
 2.5 mm Spray Nozzle      Locking Spray Grip  
 Additional Nozzles Available      800 SPI Max

\* SPRAY GUNS COME STANDARD WITH UPC BARCODED FLAG TAG.  
 SG-2200-CSK COMES CLAMHELLED AND SG-PC-025 COMES BOXED.

# SPRAYER ACCESSORIES

6" Tank Lid & 5" Basket Strainer	
Part: 34-140030-CSK	UPC: 816403006101
Part: TLS-5D-CSK	UPC: 814603006774
	
Fits 9-60 Gallon Sprayers	Durable Polypropylene
Screw On Lid w/Gasket	Drop-In Strainer

Hose Organizing Strap	
Part: HOSE-STRAP-CSK	UPC: 816403007368
	
Mount to Any Sprayer	Self-Tapping Screw Mount
Hook & Loop Fastener	Holds Up To 40' Hose

Nozzle Body Quick Clip	
Part: 31-400010-CSK	UPC: 816403009799
	
Durable Polypropylene	Attaches in Seconds
Secure Fit to Spray Booms	No Tools Needed

Elbow Nozzle Body with Check Valve		
Part: G-8235019-CSK	UPC: 814485013192	3/8"
Part: G-8235021-CSK	UPC: 814485011587	1/2"
Part: G-8235023-CSK	UPC: 814485011594	3/4"
		
Durable Polypropylene	Quick Attach Outlet	
Hose Barb Inlet	Installs in Seconds	

Tee Nozzle Body with Check Valve		
Part: G-8235025-CSK	UPC: 814485013208	3/8"
Part: G-8235027-CSK	UPC: 814485011600	1/2"
Part: G-8235029-CSK	UPC: 814485011617	3/4"
		
Durable Polypropylene	Quick Attach Outlet	
2 Hose Barb Inlets	Installs in Seconds	



### Elbow Nozzle Body

Part: G-8231001-CSK	UPC: 814485013505	3/8"
Part: G-8231003-CSK	UPC: 814485011549	1/2"
Part: G-8231005-CSK	UPC: 814485011556	3/4"



Durable Polypropylene	Quick Attach Outlet
Hose Barb Inlet	Installs in Seconds

### Tee Nozzle Body

Part: G-8231007-CSK	UPC: 814485013512	3/8"
Part: G-8231009-CSK	UPC: 814485011563	1/2"
Part: G-8231011-CSK	UPC: 814485011570	3/4"



Durable Polypropylene	Quick Attach Outlet
2 Hose Barb Inlets	Installs in Seconds

### Cross Nozzle Body

Part: G-8231013-CSK	UPC: 814485013529	3/8"
---------------------	-------------------	------



Durable Polypropylene	Quick Attach Outlet
3 Hose Barb Inlets	Installs in Seconds

### Elbow Nozzle Body Kit (2 Pack)

Part: 34-140025BLK-CSK	UPC: 816403008709
------------------------	-------------------



11/16" MPT Outlet	3/8" Hose Barb Inlet
Caps, Nuts & Strainers	Durable Polypropylene
Nylon Option Available	

### Tee Nozzle Body Kit (2 Pack)

Part: 34-140026BLK-CSK	UPC: 816403008716
------------------------	-------------------



11/16" MPT Outlet	3/8" Hose Barb Inlets
Incl: Caps, Nuts & Strainers	Durable Polypropylene
Nylon Option Available	

### Cross Nozzle Body Kit

Part: 34-140027BLK-CSK	UPC: 816403008723
------------------------	-------------------



11/16" MPT Outlet	3/8" Hose Barb Inlets
Incl: Cap, Nut and Strainer	Durable Polypropylene
Nylon Option Available	

\* PART NUMBERS ENDING IN "-CSK" INCLUDE FULL-COLOR RETAIL PACKAGING.

# SPRAYER ACCESSORIES

50 Mesh Nozzle Strainers (4 Pack)	
Part: NS-50-CSK	UPC: 816403006224
Part: NS-50-BC-CSK	UPC: 814485011501
	
Red, 50 Mesh	Drop-In Design
Ball Check (-BC Only)	Prevents Clogging

100 Mesh Nozzle Strainers (4 Pack)	
Part: NS-100-CSK	UPC: 814485011495
Part: NS-100-BC-CSK	UPC: 816403006231
	
Black, 100 Mesh	Drop-In Design
Ball Check (-BC Only)	Prevents Clogging

Wet Boom Nozzle Body Kit (Outer)	
Part: G-8244190-KIT-CSK	UPC: 816403008518
	
Outer Assy. for SSBK-PNB	Twist Operation
Quick Attach Connections	Durable Polypropylene

Wet Boom Nozzle Body Kit (Inner)	
Part: G-8234084-CSK	UPC: 810044043747
	
Inner Assy. for SSBK-PNB	On/Off Operation
Quick Attach Connection	Durable Polypropylene

Quick Attach Nozzle Caps		
Part: 34-140042-CSK	UPC: 814485011051	Yellow
Part: G-8253051-CSK	UPC: 810044041255	Black
		
Add/Remove in Seconds	Yellow for Fan Nozzles	
Gaskets Included	Black For Deflector Nozzles	

### Boom Mount Clamp (2 Pack)

Part: BCS-100-CSK	UPC: 816403006040	Sqr	1"
Part: BCR-34-CSK	UPC: 816403006057	Rnd	3/4"



Steel Construction	Includes Hardware
Additional Sizes Available	

### Round Vari-Space Boom Clamps

Part: G-8235036-CSK	UPC: 814485011471	3/4"
Part: G-8235038-CSK	UPC: 814485011488	1"



Steel Construction	2 Sizes to Match Boom
Hardware Included	For Round Pipe Booms
Additional Sizes Available	

### Square Vari-Space Boom Clamps

Part: G-8235037-CSK	UPC: 814485011440	3/4"
Part: G-8235039-CSK	UPC: 814485011457	1"



Steel Construction	2 Sizes to Match Boom
Hardware Included	For Square Pipe Booms
Additional Sizes Available	

### Snapper Hose Clamps (6 Pack)

Part: SHC-F-CSK	UPC: 816403005890	3/8"
Part: SHC-J-CSK	UPC: 816403005883	1/2"
Part: SHC-M-CSK	UPC: 816403005876	3/4"



Durable Polypropylene	3 Diameters to Match Hose
Squeeze Lock Design	Installs in Seconds
Additional Sizes Available	

### Garden Hose Valve

Part: GHV-1-BLK-CSK	UPC: 816403006217
---------------------	-------------------



3/4" FGHT Inlet	3/4" MGHT Outlet
Durable Polypropylene	Twist Valve Design

### Hose Repair Kit

Part: 34-140024-CSK	UPC: 816403006118
---------------------	-------------------



3/8" Hose Barb inlets	Screw-Type Design
Durable Nylon	Mends Broken Hose

\* ALL SPRAYER ACCESSORIES ENDING IN "-CSK" COME CLAMSHELLED WITH INFO INSERT CARD. SPRAYER ACCESSORIES AVAILABLE IN BULK OFFERING AS WELL.

# SPRAYER ACCESSORIES

## Ball Valve (2 Pack)

Part: PBV-38HB-CSK

UPC: 814485010771



3/8" Hose Barb inlet

3/8" Hose Barb Outlet

Durable Polypropylene

Twist Valve Design

Additional Sizes Available

## Inlet Strainer

Part: 33-103121-CSK

UPC: 816403006187



3/8" Hose Barb inlet

50 Mesh Steel Strainer

Durable Nylon

Prevents Contamination

## Inline Strainer

Part: 34-140164-CSK

UPC: 816403002318



Hose Barb inlet

Quick Attach Outlet

Clear Bowl Strainer

Prevents Pump Damage

## Boom Shut-Off Valve

Part: 34-140141-CSK

UPC: 816403009690



Female Quick Attach Outlet

Male Quick Attach Inlet

Durable Polypropylene

Easy On/Off Control

## Variable Pressure Regulator

Part: 34-140118-CSK

UPC: 814485018579



QA Inlet & Outlet to Boom

Hose Barb Outlet to Gun

Hose Barb Bypass to Tank

Includes 3/8" MPT Adapter

### Hose Barb QA Port Adapter

Part: EFQC-A12-CSK	UPC: 814485018579	1/2" HB
Part: EFQC-A38-CSK	UPC: 814485013581	3/8" HB



Male Quick Attach Inlet	Hose Barb Outlet
Durable Polypropylene	O-Ring Included

### MNPT x Male QA Port Adapter

Part: EFQC-M12-CSK	UPC: 814485013598
--------------------	-------------------



1/2" MNPT Inlet	Male Quick Attach Outlet
Durable Polypropylene	O-Ring Included

### MNPT x Female QA Port Adapter

Part: EF-QC-FQA/M38-CSK	UPC: 814485019835
-------------------------	-------------------



3/8" MNPT Inlet	Female Quick Attach Outlet
Durable Polypropylene	Lock Pin Included

### Dry Fill Pressure Gauges

Part: CS-1224DAB100	UPC: 816403004657	Back
Part: CS-1124DAB100	UPC: 816403000697	Bottom



2" Dial	Dry Fill
100 PSI Max	Steel Case
Additional pressure range and dial size options available.	

### Glycerin Fill Mount Pressure Gauge

Part: CS-2141GXB100	UPC: 816403000819	Bottom
---------------------	-------------------	--------



2.5" Dial	Vibration Resistant
100 PSI Max	Stainless Steel Case
Additional pressure range and dial size options available.	

### Revolt Lithium-Ion Replacement Battery

Part: REVOLT-144-B-CSK	UPC: 810044040180
------------------------	-------------------



Stay Out Longer with a Second Battery. Quick Swap to Double Your Spray Time, Replace a Lost or Damaged Battery.

# SPRAYER ACCESSORIES

## Spot Sprayer Replacement Part Kit

Part: 34-140029-CSK

UPC: 816403006163



Drain Cap, Gasket & Tether

Gun Clips & Screw

3/8" MNPT x 3/8" HB Fitting

For All Sprayer Tanks

## Spray Gun Repair Kit (SG-2200 & SG-3200)

Part: SG-2200KIT-CSK

UPC: 816403005982



Some of the most common wear items for the SG-2200 and SG-3200 spray guns. Includes all of the above.

## Brass Spray Gun Replacement Tip

Part: 900.054-8-CSK

UPC: 816403006071

#8

Part: 900.054-18-CSK

UPC: 816403006088

#18



Replacement Spray Tip. Brass Construction. Features Adjustable Nozzle & #8 or #18 Orifice.

## SG-4200 Spray Gun Replacement Tip

Part: SG-4200TIP-CSK

UPC: 816403005951



Replacement Spray Tip for the SG-4200 Spray Gun. Features Adjustable Nozzle and #18 Orifice.

## Spray Gun Replacement Tip

Part: SG-45ASSY-18-CSK

UPC: 816403005937



Replacement Spray Tip for the SG-4507F & SG-500T Spray Guns. Features Adjustable Nozzle & #18 Orifice.



# SPRAYER ACCESSORIES BULK TANKS

## FEATURES

- CHEMICAL RESISTANT POLYPROPYLENE
- RAISED FILL MARKINGS IN GALLONS & LITERS
- FULL DRAIN-OUT CAPABILITY
- STANDARD MOUNTING INSERTS
- GUN CLIP & PUMP INSERTS
- INCLUDES LID W/TETHER & DRAIN CAP W/TETHER
- CUSTOMIZABLE COLOR (MIN ORDER QTY APPLIES)
- AVAILABLE MOLD-IN SUMP (40/60 GALLON ONLY)

### 15 Gallon Bulk Tanks

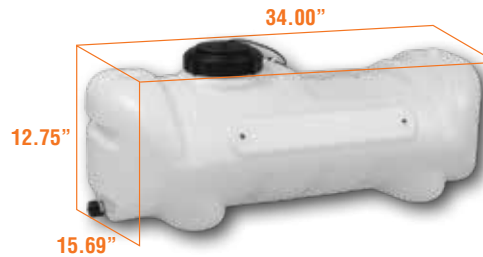

Part #	Color	Lbs	Pallet Qty	UPC
T-015-WWNA-XL	White	7	18	810044043617
T-015-YYNA-XL	Yellow			810044043624

### 25 Gallon Bulk Tanks



Part #	Color	Lbs	Pallet Qty	UPC
T-025-WWNA-XL	White	12	15	810044043631
T-025-YYNA-XL	Yellow			810044043648

### 40 Gallon Bulk Tanks

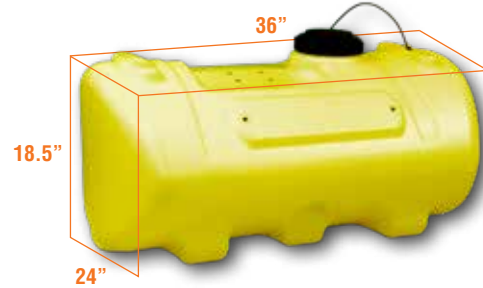

Part #	Color	Sump	Lbs	Pallet Qty	UPC
T-040-WWNA-XL	White	No	16	6	810044043655
T-040-YYNA-XL	Yellow				810044043662
T-040-WWSA-XL	White	Yes	16	6	810044043679
T-040-YYSA-XL	Yellow				810044043686

### 60 Gallon Bulk Tanks

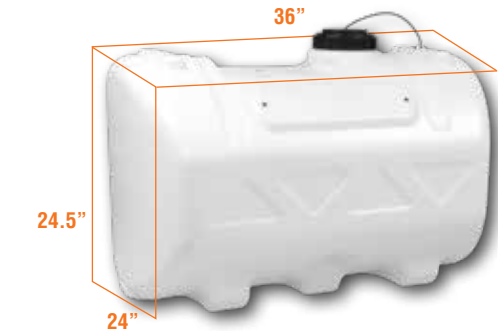

Part #	Color	Sump	Lbs	Pallet Qty	UPC
T-060-WWNA-XL	White	No	18	6	810044043693
T-060-YYNA-XL	Yellow				810044043709
T-060-WWSA-XL	White	Yes	18	6	810044043716
T-060-YYSA-XL	Yellow				810044043723



# NOZZLE CHARTS

80° Flat Fan Nozzles	PSI	Capacity Per Nozzle		Gallons/Acre 20" Spacing							
		GPM	Oz/Min	4MPH	5MPH	6MPH	7MPH	8MPH	9MPH	10MPH	12MPH
90.080.002-CSK	30	0.17	22.0	12.6	10.1	8.4	7.2	6.3	5.6	5.0	4.2
	40	0.20	26.0	14.9	11.9	9.9	8.5	7.4	6.6	5.9	5.0
	50	0.22	28.0	16.3	13.1	10.9	9.3	8.2	7.3	6.5	5.4
	60	0.24	31.0	17.8	14.3	11.9	10.2	8.9	7.9	7.1	5.9
	75	0.27	34.8	20.0	16.1	13.4	11.5	10.0	8.9	8.0	6.6
90.080.003-CSK	30	0.26	33.0	19.3	15.4	12.9	11.0	9.7	8.6	7.7	6.4
	40	0.30	38.0	22.0	17.8	14.9	12.7	11.1	9.9	8.9	7.4
	50	0.34	44.0	25.0	20.0	16.8	14.4	12.6	11.2	10.1	8.4
	60	0.37	47.0	27.0	22.0	18.3	15.7	13.7	12.2	11.0	9.2
	75	0.42	52.9	30.4	24.8	20.6	17.7	15.4	13.7	12.4	10.4
90.080.004-CSK	30	0.35	45.0	26.0	21.0	17.3	14.9	13.0	11.6	10.4	8.7
	40	0.40	51.0	30.0	24.0	19.8	17.0	14.9	13.2	11.9	9.9
	50	0.45	58.0	33.0	27.0	22.0	19.1	16.7	14.9	13.4	11.1
	60	0.49	63.0	36.0	29.0	24.0	21.0	18.2	16.2	14.6	12.1
90.080.006-CSK	30	0.43	55.0	32.0	26.0	21.0	18.2	16.0	14.2	12.8	10.6
	40	0.50	64.0	37.0	30.0	25.0	21.0	18.6	16.5	14.9	12.4
	50	0.56	72.0	42.0	33.0	28.0	24.0	21.0	18.5	16.6	13.9
	60	0.61	78.0	45.0	36.0	30.0	26.0	23.0	20.0	18.1	15.1
	75	0.67	86.0	49.6	39.7	33.1	28.7	25.4	22.1	20.0	16.7
90.080.008-CSK	30	0.69	88.0	51.0	41.0	34.0	29.0	26.0	23.0	20.0	17.1
	40	0.80	102.0	59.0	48.0	40.0	34.0	30.0	26.0	24.0	19.8
	50	0.89	114.0	66.0	53.0	44.0	38.0	33.0	29.0	26.0	22.0
	60	0.98	125.0	73.0	58.0	49.0	42.0	36.0	32.0	29.0	24.0
75	1.09	140.0	81.8	65.0	54.9	47.0	40.3	35.8	32.5	26.9	

110° Air Induction Nozzles	PSI	Capacity Per Nozzle		Gallons/Acre 20" Spacing						
		GPM	Oz/Min	4MPH	5MPH	6MPH	8MPH	10MPH	12MPH	15MPH
G-8259492-CSK	30	0.17	22	12.6	10.1	8.4	6.3	5	4.2	3.4
	40	0.2	26	14.9	11.9	9.9	7.4	5.9	5	4
	50	0.22	28	16.3	13.1	10.9	8.2	6.5	5.4	4.4
	60	0.24	31	17.8	14.3	11.9	8.9	7.1	5.9	4.7
	75	0.27	35	20	16	13.4	10	8	6.7	5.3
G-8259493-CSK	90	0.3	38	22	17.8	14.9	11.1	8.9	7.4	5.9
	30	0.22	28	16.3	13.1	10.9	8.2	6.5	5.4	4.4
	40	0.25	32	18.6	14.9	12.4	9.3	7.4	6.2	5
	50	0.28	36	21	16.6	13.9	10.4	8.3	6.9	5.5
	60	0.31	40	23	18.4	15.3	11.5	9.2	7.7	6.1
G-8259494-CSK	75	0.34	44	25	20	16.8	12.6	10.1	8.4	6.7
	90	0.38	49	28	23	18.8	14.1	11.3	9.4	7.5
	30	0.26	33	19.3	15.4	12.9	9.7	7.7	6.4	5.1
	40	0.3	38	22	17.8	14.9	11.1	8.9	7.4	5.9
	50	0.34	44	25	20	16.8	12.6	10.1	8.4	6.7
G-8259495-CSK	60	0.37	47	27	22	18.3	13.7	11	9.2	7.3
	75	0.41	52	30	24	20	15.2	12.2	10.1	8.1
	90	0.45	58	33	27	22	16.7	13.4	11.1	8.9
	30	0.35	45	26	21	17.3	13	10.4	8.7	6.9
	40	0.4	51	30	24	19.8	14.9	11.9	9.9	7.9
G-8259496-CSK	50	0.45	58	33	27	22	16.7	13.4	11.1	8.9
	60	0.49	63	36	29	24	18.2	14.6	12.1	9.7
	75	0.55	70	41	33	27	20	16.3	13.6	10.9
	90	0.6	77	45	36	30	22	17.8	14.9	11.9
	30	0.43	55	32	26	21	16	12.8	10.6	8.5
G-8259557-CSK	40	0.5	64	37	30	25	18.6	14.9	12.4	9.9
	50	0.56	72	42	33	28	21	16.6	13.9	11.1
	60	0.61	78	45	36	30	23	18.1	15.1	12.1
	75	0.68	87	50	40	34	25	20	16.8	13.5
	90	0.75	96	56	45	37	28	22	18.6	14.9
G-8259557-CSK	30	0.52	67	39	31	26	19.3	15.4	12.9	10.3
	40	0.6	77	45	36	30	22	17.8	14.9	11.9
	50	0.67	86	50	40	33	25	19.9	16.6	13.3
	60	0.73	93	54	43	36	27	22	18.1	14.5
	75	0.82	105	61	49	41	30	24	20	16.2
90	0.9	115	67	53	45	33	27	22	17.8	

140° Deflector Nozzles	PSI	Capacity Per Nozzle		Gallons/Acre							
		GPM	Oz/Min	30" Spacing				40" Spacing			
				5MPH	6MPH	7MPH	8MPH	5MPH	6MPH	7MPH	8MPH
DF2.0-CSK	10	0.20	26	7.9	6.6	5.7	5.0	5.9	5.0	4.2	3.7
	20	0.28	36	11.1	9.2	7.9	6.9	8.3	6.9	5.9	5.2
	30	0.35	45	13.9	11.6	9.9	8.7	10.4	8.7	7.4	6.5
	40	0.40	51	15.8	13.2	11.3	9.9	11.9	9.9	8.5	7.4
DF2.5-CSK	10	0.25	32	9.9	8.3	7.1	6.2	7.5	6.2	5.3	4.7
	20	0.36	46	14.0	11.5	10.0	8.8	10.5	8.8	7.6	6.6
	30	0.44	56	17.0	14.5	12.5	11.0	13.0	11.0	9.3	8.1
DF3.0-CSK	40	0.50	64	20.0	16.5	14.0	12.5	15.0	12.5	10.5	9.3
	10	0.30	39	11.9	9.9	8.6	7.5	8.9	7.5	6.3	5.6
	20	0.42	54	16.7	13.8	11.9	10.4	12.5	10.4	8.9	7.8
DF4.0-CSK	30	0.53	68	20.9	17.4	14.9	13.1	15.6	13.1	11.1	9.8
	40	0.60	77	23.7	19.8	17.0	14.9	17.9	14.9	12.8	11.1
	10	0.40	52	15.8	13.2	11.4	10.0	11.8	10.0	8.4	7.4
	20	0.56	72	22.2	18.4	15.8	13.8	16.6	13.8	11.8	10.4
DF5.0-CSK	30	0.70	90	27.8	23.2	19.8	17.4	20.8	17.4	14.8	13.0
	40	0.80	102	32	26.4	22.6	19.8	23.8	19.8	17.0	14.8
	10	0.50	64	20	16.5	14.1	12.4	14.9	12.4	10.6	9.3
	20	0.71	91	28	23	20	17.6	21	17.6	15.1	13.2
DF7.5-CSK	30	0.87	111	34	29	25	22	26	22	18.5	16.1
	40	1.00	128	40	33	28	25	30	25	21.0	18.6
	10	0.75	96	30	25	21	19	22	19	15.9	14.0
	20	1.07	137	42	35	30	26	32	26	23	19.8
DF10.0-CSK	30	1.31	167	51	44	38	33	39	33	28	24
	40	1.50	192	60	50	42	38	45	38	32	28
	10	1.00	128	40	33	28	25	30	25	21	19
	20	1.42	182	56	46	40	35	42	35	30	26
30	1.74	222	68	58	50	44	52	44	37	32	
40	2.00	256	80	66	56	50	60	50	42	37	

# BOOMLESS NOZZLE CHARTS



PART: BN2BP152FWX - GALLONS PER ACRE					
PSI	GPM	3 MPH	4 MPH	5 MPH	6 MPH
20	2	15.5	12	9.5	7
30	2.3	17	12.5	10	9
40	2.9	22	16	13	10.5

PART: BN2BP116LSX OR BN2BP116RSX - GALLONS PER ACRE					
PSI	GPM	3 MPH	4 MPH	5 MPH	6 MPH
20	1.2	12.4	9.3	7.4	6.2
30	1.4	14.4	10.8	8.7	7.2
40	1.6	16.5	12.4	9.9	8.3

PART: BN2BP125FWX - GALLONS PER ACRE					
PSI	GPM	3 MPH	4 MPH	5 MPH	6 MPH
20	1.5	16	12	8	7.5
30	1.7	18	13	11	9
40	2	21	16	12	10

PART: BN2BP088LSX OR BN2BP088RSX - GALLONS PER ACRE					
PSI	GPM	3 MPH	4 MPH	5 MPH	6 MPH
20	0.8	8.3	6.2	5	4.1
30	1	10.3	7.7	6.2	5.2
40	1.2	12.4	9.3	7.4	6.2

PART: 6540-01 - GALLONS PER ACRE - 180° NOZZLE CAP							
PSI	GPM	SWATH	3 MPH	4 MPH	5 MPH	8 MPH	10 MPH
30	1.7	44'	6.4	4.8	3.8	2.4	1.9
40	2.0	46'	7.2	5.4	4.3	2.7	2.2
50	2.2	48'	7.6	5.7	4.5	2.9	2.3
60	2.4	50'	7.9	5.9	4.8	3.0	2.4

90° Nozzle Cap Has Same GPA but 1/2 GPM & Swath

PART: 6541-01 - GALLONS PER ACRE - 180° NOZZLE CAP							
PSI	GPM	SWATH	3 MPH	4 MPH	5 MPH	8 MPH	10 MPH
30	3.7	50'	12.0	9.2	7.3	4.6	3.7
40	4.2	50'	13.9	10.4	8.3	5.2	4.2
50	4.6	52'	14.6	10.9	8.8	5.5	4.4
60	5.0	52'	15.8	11.9	9.5	5.9	4.8

90° Nozzle Cap Has Same GPA but 1/2 GPM & Swath

PART: 6542-01 - GALLONS PER ACRE - 180° NOZZLE CAP							
PSI	GPM	SWATH	3 MPH	4 MPH	5 MPH	8 MPH	10 MPH
30	5.1	54'	15.6	11.6	9.3	5.8	4.7
40	5.9	54'	18.0	13.5	10.8	6.8	5.4
50	6.7	56'	19.7	14.8	11.8	7.4	5.9
60	7.1	58'	20.2	15.1	12.1	7.6	6.1

90° Nozzle Cap Has Same GPA but 1/2 GPM & Swath

Charts Tabulation Based on  
Spraying Water Amount Shown  
is Per Nozzle Type

# SPRAYING SIMPLE™



FREE MOBILE SPRAY ASSISTANT

iPhone



Android

## FEATURES

SELECT YOUR SPRAYING EQUIPMENT BY BOOM OR NOZZLE, THEN SET DESIRED SPEED AND PSI.

MEASURE YOUR AREA BY WALKING THE PERIMETER OR BY MANUALLY ADDING PIN POINTS TO THE MAP.

INPUT YOUR DESIRED SPEED RANGE FOR CONSISTENT SPRAYING. MONITOR IT WITH GPS SPEEDOMETER AND AUDIO WARNINGS FOR IMPROPER SPEED.



[www.valleyind.com](http://www.valleyind.com)

Fluid Components,  
Ag Parts & Pressure Washer  
Accessories



[www.cometpump.com](http://www.cometpump.com)

Diaphragm Pumps, High  
Pressure Plunger Pumps  
& Accessories



[www.everflopump.com](http://www.everflopump.com)

12 Volt Diaphragm Pumps,  
Fresh Water Pumps, Soft Wash  
Pumps & Accessories



[www.mistsprayers.com](http://www.mistsprayers.com)

PTO & Engine Driven  
Mist Sprayers



[www.bestwayag.com](http://www.bestwayag.com)

Professional Ag Sprayers,  
Attachments, & Accessories



MASTER MFG  
180 LAKE AVENUE N.  
PAYNESVILLE, MN 56362

MM-CATALOG-2024

ORDERS: 800-864-1649

SUPPORT: 800-825-5397

FAX: 320-243-8030

ONLINE: [WWW.MASTER-MFG.COM](http://WWW.MASTER-MFG.COM)

EMAIL: [SALES@VALLEYIND.COM](mailto:SALES@VALLEYIND.COM)